

**FOSCAM<sup>®</sup>**

# ***User Manual***

**Indoor HD IP Camera**



Model: C1

V1.3

## Table of Contents

---

Security Warning.....	1
1 Overview.....	1
1.1 Key Features.....	2
1.2 Read Before Use.....	2
1.3 Package Contents.....	2
1.4 Physical Description.....	2
1.5 Hardware Installation.....	4
2 Access the IP Camera.....	4
2.1 Wired Connection.....	4
2.2 Wireless Connection.....	6
2.3 Access the Camera in WAN.....	11
2.4 Using the VLC player.....	15
2.5 IP camera connection to the server.....	17
3 Surveillance Software GUI.....	17
3.1 login Window.....	18
3.2 Setup Wizard.....	19
3.3 Surveillance Window.....	21
4 Advanced Camera Settings.....	26
4.1 Setup Wizard.....	26
4.2 Status.....	26
4.3 Basic Settings.....	29
4.4 Network.....	38
4.5 Video.....	48
4.6 Alarm.....	51
4.7 Record.....	55
4.8 Firewall.....	59
4.9 System.....	59
5 Playback.....	63
6 Appendix.....	65
6.1 Frequently Asked Questions.....	65
6.2 Default Parameters.....	72
6.3 Specifications.....	73
6.4 CE & FCC.....	74
7 Obtaining Technical Support.....	75

# Security Warning

## Safeguarding Your Privacy

Foscam cameras require good security practices to safeguard your privacy. You can help protect your camera by changing the default username and/or password. Input a username and/or password that is at least 8 – 10 characters or longer. Try to use a combination of lower-case and upper-case letters as well as numbers and special characters. The more complex the username and password, the harder it will be to guess by an unauthorized user.

You should update your camera regularly at <http://www.foscam.us/firmware.html>. Make sure your camera has the latest firmware installed for your specific camera model. The latest firmware for Foscam cameras utilizes protection against various types of online hacking, cracking, and unauthorized access. Doing so will make your device more secure, may add features, and will contain bug fixes to make your device work faster.

## 1 Overview

FOSCAM Indoor HD IP Camera is an integrated wireless IP Camera with a color CMOS sensor which enable to view in High Definition resolution. It combines a high quality digital video camera, with a powerful web server, to bring clear video to your desktop and mobile devices no matter where by your local network or over the Internet.

These cameras support P2P function. Thanks to the P2P easy access technology, you don't need to do complicated Port Forwarding and DDNS settings, you just need to scan the QR code on the bottom of the camera to connect it to smart phone, or input the UID on CMS software to realize remote access.

With flexible move of 360-degree horizontally and 180-degree vertically, FOSCAM IP Camera provides users with more comprehensive controls over a monitored site. The camera supports H.264 video compression technology, dramatically reduces file size and saves network bandwidth.

The camera is based on the TCP/IP standard. A built-in WEB server inside which could support Internet Explorer simplifies the management and maintenance of your device is simplified by accessing the website of your camera through network.

The camera is designed for indoor surveillance with wide applications such as at home, in retail store and in office. Controlling the camera and managing images are simplified by using the provided web interface across the network in either wired or wireless way.

FOSCAM provides Smart Phone APP for Android and iPhone users, please search and install Foscam App named **Foscam** on App Store and Google Play for iOS and Android devices, then you can view your camera anywhere, anytime on your smart mobile devices.

## 1.1 Key Features

- Standard H.264 video compression algorithm to satisfy the transmission of high definition video in narrow bandwidth network
- P2P feature for easy access
- Megapixel HD video
- Support IE/Firefox/Google/Safari browser
- Support WEP,WPA-PSK and WPA2-PSK Encryption
- Wireless connection is compliant with IEEE 802.11b/g/n WI-FI, up to 150Mbps
- IR night vision (Range: 8m)
- Support image snapshot
- Support dual-stream
- Support SD Card storage up to 32GB
- Support IR-Cut auto switch
- Embedded free FOSCAM DDNS(dynamic domain name service) Service
- Supporting the Third Party Domain Name Service
- Support two-way audio
- Support ONVIF protocols
- Multi-level users management with password protection
- Motion detection alert via email or upload image to FTP
- Provide free Android and iPhone APP for viewing live video provide free Central Management Software to manage and monitor multiple cameras
- Support record schedule

## 1.2 Read Before Use

Please first verify that all contents received are complete according to the Package Contents listed below. Before the IP Camera is installed, please carefully read and follow the instructions in the Quick Installation Guide to avoid damage due to faulty assembly and installation. It also ensures the product is used properly as intended.

## 1.3 Package Contents

● IP Camera × 1	● AC Adapter × 1
● Quick Installation Guide × 1	● Power Line × 1
● CD×1	● Security Warning Card × 1

## 1.4 Physical Description

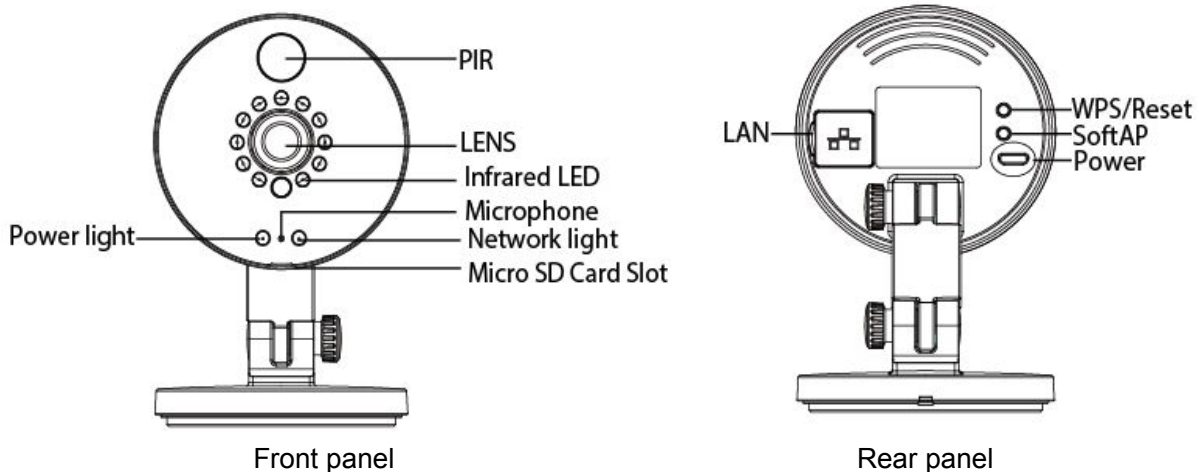

### Front panel:

- PIR: The PIR ( Passive Infrared ) is electronic devices which are used in some security alarm systems to detect motion of an infrared emitting source, usually a human body.
- LENS: Fixed focus lens.
- Infrared LED: Infrared LEDs for night vision.
- Microphone: Built-in microphone.
- Micro SD Card slot: Supports up to 32GB SD card for storing the video.

### Rear panel:

- Power Light: If the power supply works fine, the light will be on.
- LAN: 10/100 Mbps RJ-45 port for wired connection
- SoftAP: Press the SoftAP button for more than 2 seconds. The Network light indicator begins to twinkle every 0.1 seconds.
- WPS/Reset
  - WPS: Push both WPS/Reset button on the camera and wireless router within 1 minute, the camera will connect to the wireless router automatically, in WPS process, the Network light will blink every 0.4 seconds;
  - Reset: Push and hold the WPS/Reset button for more than 10 seconds to set the camera to factory default, the Power light will blink every 0.4 seconds;
- Power: DC 5V/1A Power supply.

The flashing status of the Power light and Network light are shown in the following table.

Light	Flashing Status	Description
Power light	off	The power don't work properly.
	on	The power supply works fine.
	Flashing every 0.4 seconds	Reset to take effect
Network light	off	No Wireless connection
	Constant Flash	Wired connection
	Slow Flash every 1.0 second	Wi-Fi connected
	Flashing every 0.4 seconds	WPS is connecting
	Flashing every 0.2 seconds	EZLink takes effect

Flashing every 0.1 seconds

SoftAP is started

## 1.5 Hardware Installation

1. Rotate the base of the camera (gray section highlighted below) so tabs a and b overlap, then remove the base.
2. According to the monitored area, install the base of the camera on the ceiling or wall with expansion screws.
3. Ensure tabs a and b align, and push the camera body to make it flush with the base. Rotate the camera body, so that a and b do not overlap, the installation is complete.

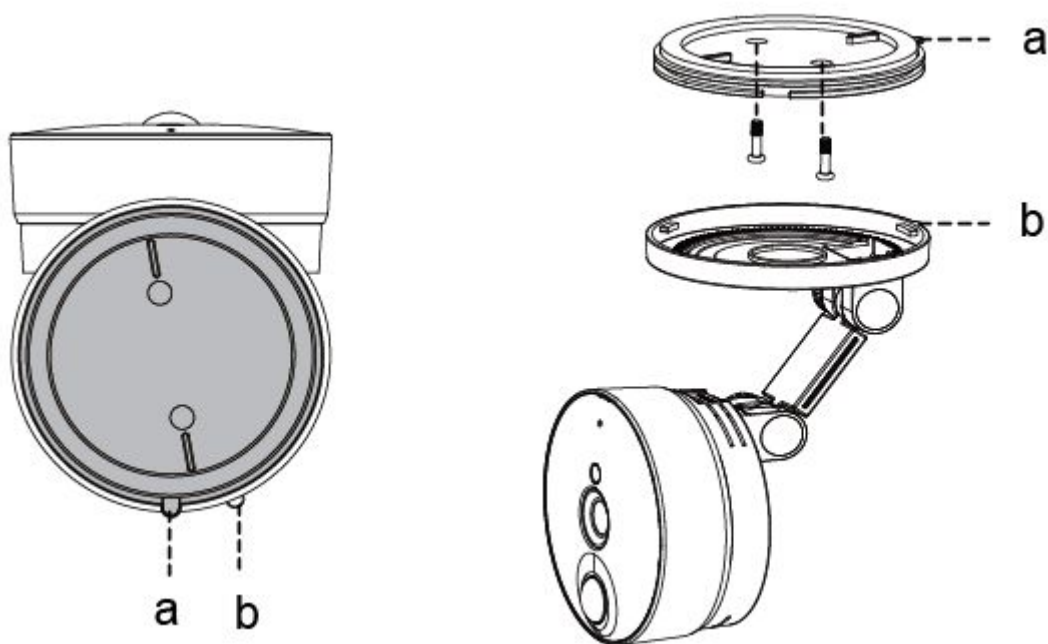

## 2 Access the IP Camera

### 2.1 Wired Connection

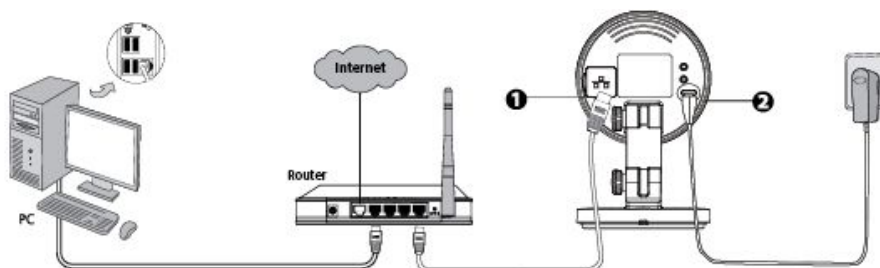

1. Connect the camera to the LAN network (Router or Switch) via network cable.

2. Connect the power adapter to the camera.
3. Insert the CD into the CD drive of your computer.
4. Go to the folder "IP Camera Search Tool" and find the folder "For Windows OS" or "For Mac OS". Copy and paste the IP camera tool file to your computer, or drag it onto your Desktop.



Shortcut icon for Windows OS



Shortcut icon for Mac OS

**Notes:**

- If your computer ( Windows OS ) supports autorun function, you can find the corresponding file in the opened control panel.
- If your computer doesn't have CD drive, you can download the IP camera tool from our website for free.

The camera supports HTTP and HTTPS protocols, you can access the camera in two ways.

**(1) http:// LAN IP + HTTP Port NO.**

The default HTTP port NO. is 88. Double click the IP Camera Tool icon to run, and it should find the camera's IP address automatically after you plug in the network cable.

Camera name	IP Address	Device ID	Device type
IPCAM	Http://192.168.11.220:88	00626E4D8A55	H

Double click the IP address of the camera; the camera login page should be open in your default browser.

**(2) https:// LAN IP + HTTPS Port NO.**

The default HTTPS port NO. is 443. You can use the URL to access the camera: https:// LAN IP + HTTPS port NO.

Go to **Settings - Network - Port** panel, you can see and change the HTTP and HTTPS port NO.

Port	
HTTP Port	88
HTTPS Port	443
ONVIF Port	888
RTSP port	554

**NOTE:**

When logging in for the first time, you will need to download and install the add-on.

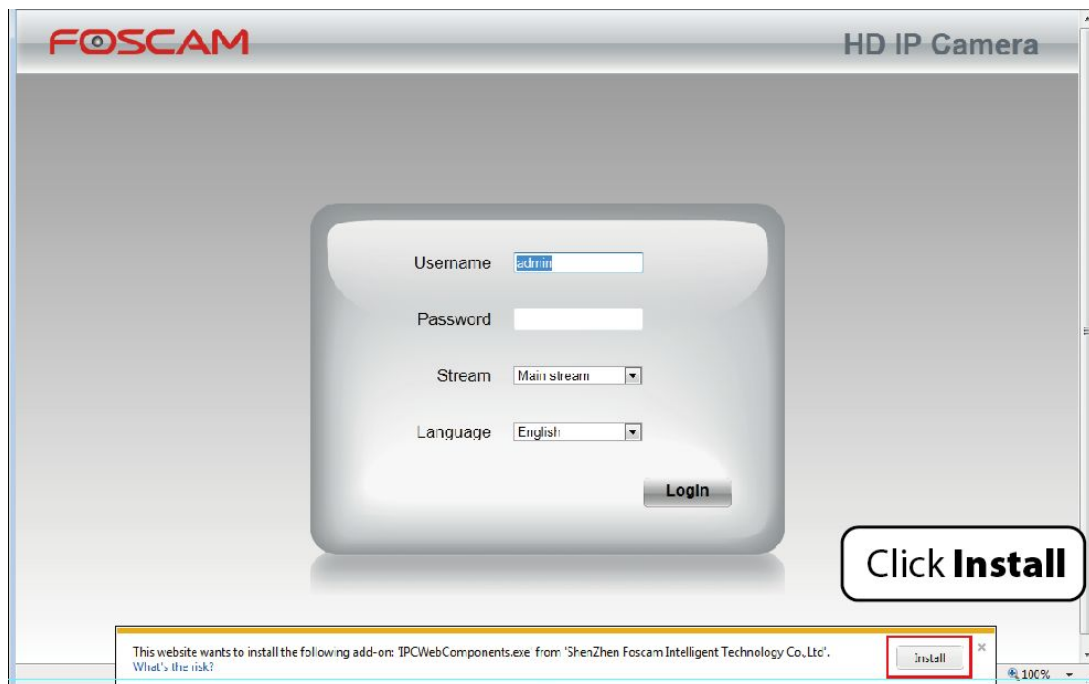

## 2.2 Wireless Connection

There are some ways of wireless connection: EZLink connection, soft AP connection and WPS connection.

- **EZLink connection:** Use the mobile phones or other mobile devices to download APP, then connect the camera and the wireless router by the APP. The procedure of the EZLink connection, please refer to the Quick Installation Guide.
- **Soft AP connection:** Use the mobile device which can search for the wireless network, Then use the web browser to visit <http://192.168.1.1:88> by the mobile device. Follow the Setup Wizard to finish the settings.
- **WPS connection:** WI-FI Protected Set-up, Press and hold the WPS button on your wireless router and your camera within 60 seconds. So that your camera and wireless router connect successfully.

### 2.2.1 Soft AP Connection

To ensure that the ethernet cable and the camera is disconnected before you begin.

1. Start camera: power on, the indicator light of camera will light on.
2. Press the Soft AP button for 3-5 seconds. The Network light begins to twinkle at very high frequency (every 0.1 seconds).
3. Use a terminal which could search the WLAN (desktop, laptop, mobile phone, or pad. This part takes laptop as an example.) to search for the AP named "C1\_\*\*\*\*\*" for connection. (\*\*\*\*\* indicate the last six letters of camera's MAC ID. )



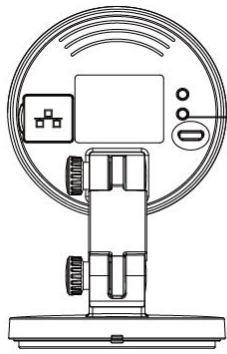

IP Camera

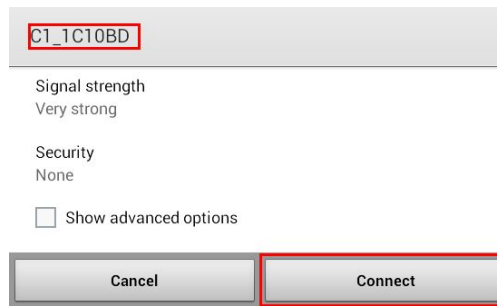

The WLAN page in the terminal device

4. After finishing Soft AP connection, use the web browser of the terminal to visit <http://192.168.1.1:88>.

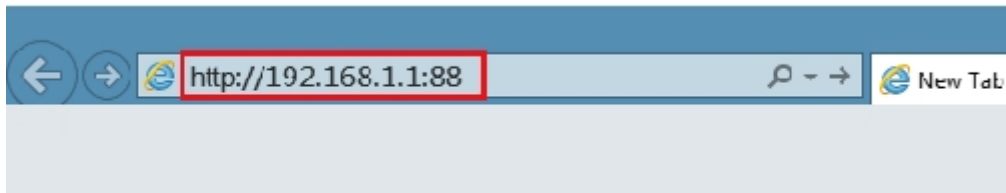

5. Log in the camera ( Default username is admin with no password ). When log in for the first time, you need to change the username and password.

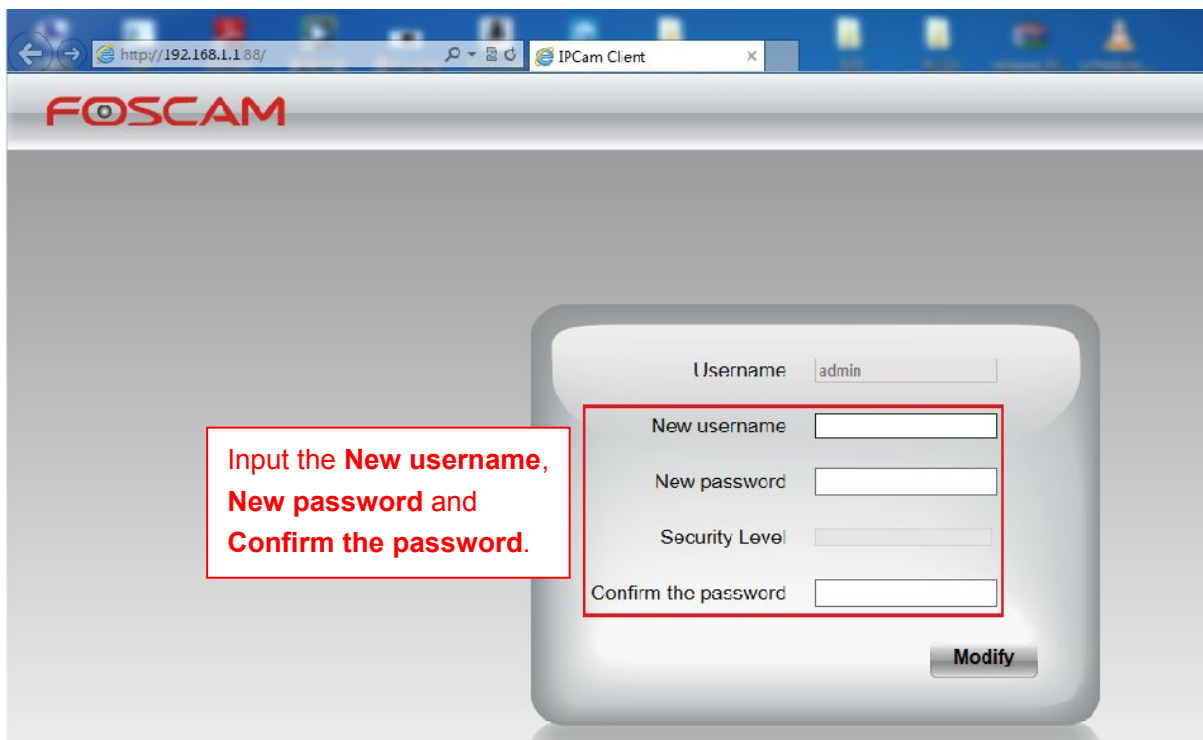

6. After logging in for the first time, it will go to "Setup Wizard" automatically. Please set the basic

parameters of the camera, such as camera name, camera time, wireless settings (The camera connect to your wireless router: Wireless Network List - enter the password of your wireless router ), IP configuration.

### Setup Wizard

Step 1 of 5 - Soft AP Password Settings

SSID	C1_000001
Encryption	WPA/WPA2
Password	.....
New password	
Security Level	
Confirm the password	

### Setup Wizard

Step 2 of 5 - Camera Name

Camera Name	<input type="text" value="C1"/> <p>The maximum Device Name length is 20, support English, numbers, letters and symbols</p>
-------------	----------------------------------------------------------------------------------------------------------------------------

### Setup Wizard

Step 3 of 5 - Camera Time

Time Zone	(GMT) Greenwich mean time; London, Lisbon, ▾
Sync with NTP server	<input checked="" type="checkbox"/>
NTP Server	time.nist.gov ▾
PC Time	<input type="text" value="2014-11-20"/> <input type="text" value="00"/> <input type="text" value="58"/> <input type="text" value="17"/> <input type="button" value="Sync with PC"/>
Date Format	YYYY-MM-DD ▾
Time Format	24-hour ▾
use DST	<input type="checkbox"/>
Ahead Of Time	<input type="text" value="0"/> Minute

### Setup Wizard

#### Step 4 of 5 - Wireless Settings

#### Wireless Network List

SSID(Network Name)	Encryption	Quality
wutingjun	WPA/WPA2	
TP-LINK_3B9E4E	WPA/WPA2	
Sera	WPA/WPA2	
TP-LINK_YF	WPA/WPA2	
TP-LINK_CB209C	WPA/WPA2	
WX15	WPA	
TP-LINK_TEST	WPA/WPA2	
ZTE-932C04	WPA	
WEILI	WPA/WPA2	
doc	WPA/WPA2	

Pages: 4 << 1 2 3 >>

SSID	<input type="text" value="doc"/>
Encryption	<input type="text" value="WPA/WPA2"/>
Password	<input type="password" value="••••••••"/>

The maximum password length is 63, including numbers, letters and symbols ~ ! @ # % ^ \* ( ) \_ + { } : " | < > ? ` - ; ' \ , . /

### Setup Wizard

#### Step 5 of 5 - IP Configuration

Obtain IP From DHCP

IP Address	<input type="text" value="192.168.1.104"/>
Subnet Mask	<input type="text" value="255.255.255.0"/>
Gateway	<input type="text" value="192.168.1.1"/>
Primary DNS Server	<input type="text" value="211.162.78.1"/>
Secondary DNS Server	<input type="text" value="211.162.78.2"/>

**Notes:**

- We recommend you to choose to manually set the IP when you know some knowledge of the network.
- It needs about 1 minute to connect the camera to your router.

7. After completing the setup wizard, you should press the Soft AP button for 3-5 seconds to cancel the Soft AP connection mode, this is located on the back of your camera. The Network light begins to slowly flash(once per second), it indicates that the wireless connection is successful.

8. Please make sure that the wireless device connect your laptop to the router which your camera has

connected to.

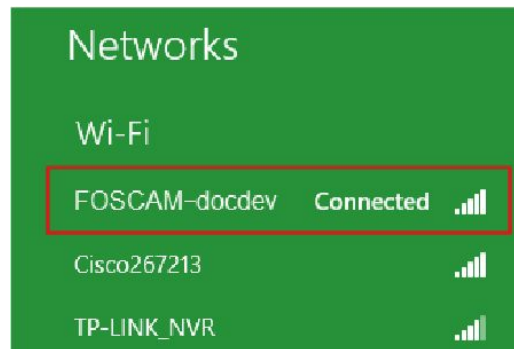

9. Open the CD named "FOSCAM", go to the folder "IP Camera Search Tool" and find the folder "For Windows OS" or "For Mac OS". Copy and paste the IP camera tool file to your wireless device, or drag it onto your desktop.



#### Notes:

- You could also download the IP camera tool from our website for free.
- If you have multiple cameras and you cannot determine which camera you are going to log in. Please match the "Device MAC address" on the search tool with the MAC address on the label pasted of each camera.

10. Double-click the camera list here, and your default browser will open up to the login page. Input the username and password you has changed. Then, you will see the live video of your baby on the interface.

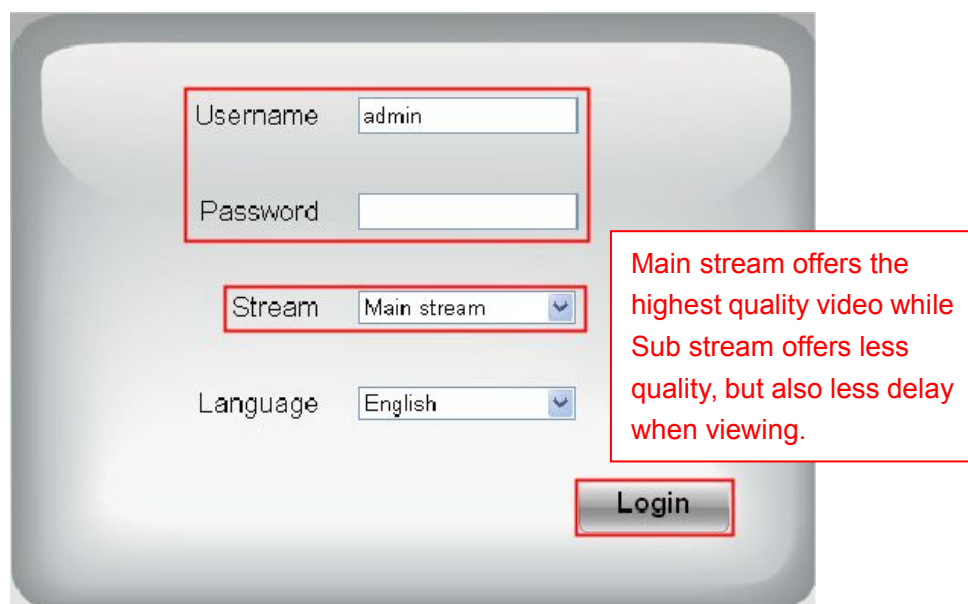

Now, you could use your camera in LAN.

**Note:**

64-bit browser is not supported.

## 2.2.2 WPS (WI-FI Protected Set-up)

**Before using WPS wireless connection, you need to:**

- Make sure that your wireless router has the WPS function, and has been properly connected to the Internet.
- WPS button on the wireless router is typically located on the front panel or rear panel. TP-LINK router's WPS button is called QSS (Quick Security Setup).
- Make sure that the ethernet cable and the camera is disconnected.

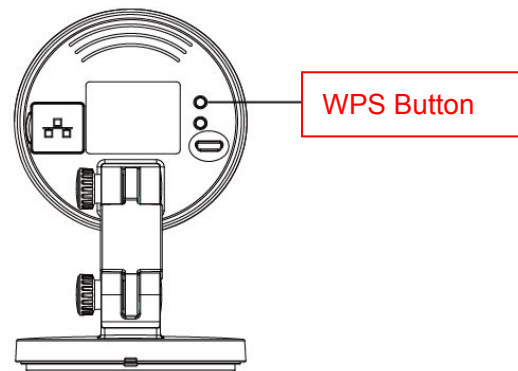

- (1) Press and hold the WPS button for three seconds. The Network light of the camera begins to twinkle at high frequency. (every 0.4 seconds)
- (2) Press and hold the WPS button for three seconds on your wireless router within 60 seconds. Then the camera will automatically create a secure wireless connection to your router in about 60 seconds.
- (3) The IP Camera Tool will search the camera's LAN IP. Make sure the PC and the camera share the same subnet.

**NOTE :**

**The security mode of router cannot be WEP, or else the WPS settings may be failed.**

## 2.3 Access the Camera in WAN

### 2.3.1 Static IP Addresses

Users with static IP addresses do not need to set DDNS service settings for remote access. After you have finished connecting the camera using the LAN IP address and port forwarding, you can access the camera directly from Internet using the WAN IP address and port number.

## How to Obtain the WAN IP address from a public website ?

To obtain your WAN IP address, enter the following URL in your browser: <http://www.whatismyip.com>. Your current WAN IP will be shown on the webpage.



### 2.3.2 Remote Access

If you want to access your camera by web browser outside of your LAN, you need to configure following configurations.

1. Choose "Settings" on the top of the camera web page, then go to the "Network > IP Configuration" section on the left side of the screen, then uncheck the Obtain IP DHCP.

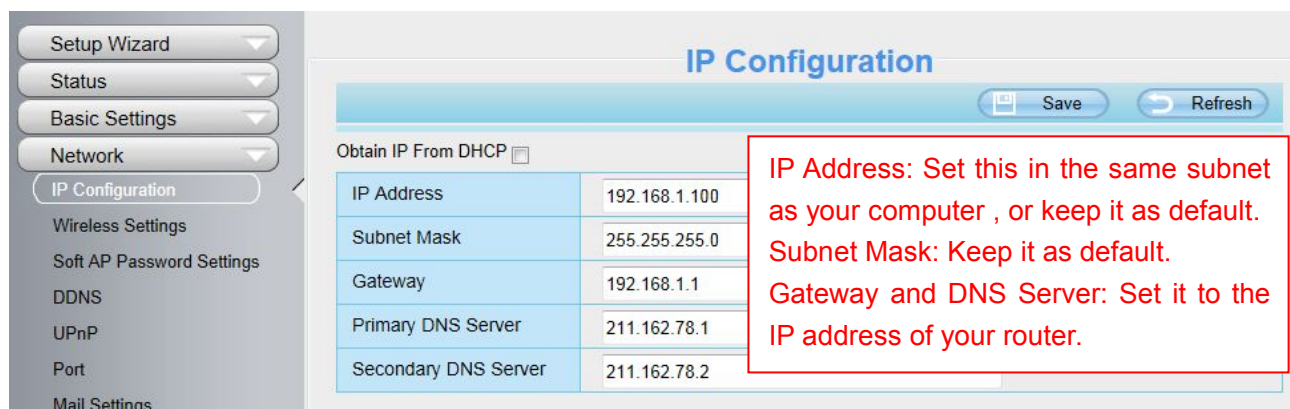

2. Enable UPnP and DDNS in the camera's settings page. We recommend you to use the DDNS by factory default.



The screenshot shows the UPnP configuration page. The 'Enable UPnP' checkbox is checked, and the dropdown menu is set to 'No'. A red box highlights the text 'Select Yes and click Save.'

The screenshot shows the DDNS configuration page. The 'Enable DDNS' checkbox is checked. The 'Manufacturer's DDNS' field contains 'test09.myfoscam.org'. A red box highlights the text 'Click Enable DDNS and click Save. The content in the Manufacture's DDNS column is the domain name of your camera.'

3. You can see the port of your camera here. If you want to set Remote Access for several cameras on the same network, you will need to change the HTTPS port for each camera.

The screenshot shows the Port configuration page. The page displays a table with the following ports:

HTTP Port	88
HTTPS Port	443
ONVIF Port	888
RTSP port	554

4. If the UPnP of the router has been enable, you do not need to perform following steps. Otherwise, you need to select one of the following methods to configure port forwarding on your router. For these steps, we will be using the TP-LINK brand wireless router as an example.

- **If there is a UPnP function in your router:**

Choose "Forwarding > UPnP", make sure that the Current UPnP Status is Enabled.

**UPnP**

Current UPnP Status: **Enabled** Disable

**Current UPnP Settings List**

ID	App Description	External Port	Protocol	Internal Port	IP Address	Status
Refresh						

● **If there is no UPnP function in your router:**

You need to manually add port forwarding, refer to the following steps. You need go to the “Forwarding > Virtual Servers” panel for setup.

**Virtual Servers**

ID	Service Port	Internal Port	IP Address	Protocol	Status	Modify
<span>Add New...</span> <span>Enable All</span> <span>Disable All</span> <span>Delete All</span>						
<span>Previous</span> <span>Next</span>						

Click Add New.

**Add or Modify a Virtual Server Entry**

Service Port:  (XX-XX or XX)

Internal Port:  (XX, Only valid for single Service Port or leave it blank)

IP Address:

Protocol:

Status:

Common Service Port:

Input the port and IP address of your camera and click Save.

Save Back

**Virtual Servers**

ID	Service Port	Internal Port	IP Address	Protocol	Status	Modify
1	443	443	192.168.1.100	ALL	Enabled	<a href="#">Modify</a> <a href="#">Delete</a>
<span>Add New...</span> <span>Enable All</span> <span>Disable All</span> <span>Delete All</span>						
<span>Previous</span> <span>Next</span>						

Here you have finished the Port Forwarding setup.



5. Now you can access your IP camera by https://domain name: HTTPS port via the Internet.

## 2.4 Using the VLC player

The camera supports RTSP streaming, here you can view the camera by VLC player.

**RTSP URL** [rtsp:// \[user name\]:\[password\]@IP:Port number/videostream](rtsp://[user name]:[password]@IP:Port number/videostream)

The part in the square brackets can be omitted.

**user name & password:** The user name and password to access the camera. This part can be omitted.

**IP:** WAN or LAN IP address.

**Port NO. :** If there is the RTSP port number on the Port page, you must only use RTSP port number. otherwise, you must only use http port number.

**Video stream:** Three modes are supported: video Main, video Sub and audio. Video Sub is a better choice in bad network condition. If you select audio, you can only hear sound without seeing picture.

### For example:

IP: 192.168.1.11

RTSP Port number: 554

User name: admin

Password: 123

Enter either one of the following four URLs in the VLC

1. rtsp://admin:123@192.168.1.11:554/videoMain
2. rtsp:// @192.168.1.11:554/videoMain
3. rtsp://:123@192.168.1.11:554/videoMain
4. rtsp://admin@192.168.1.11:554/videoMain

Open the VLC, and go to “Media”--“Open Network Stream” option, then enter the URL in VLC.

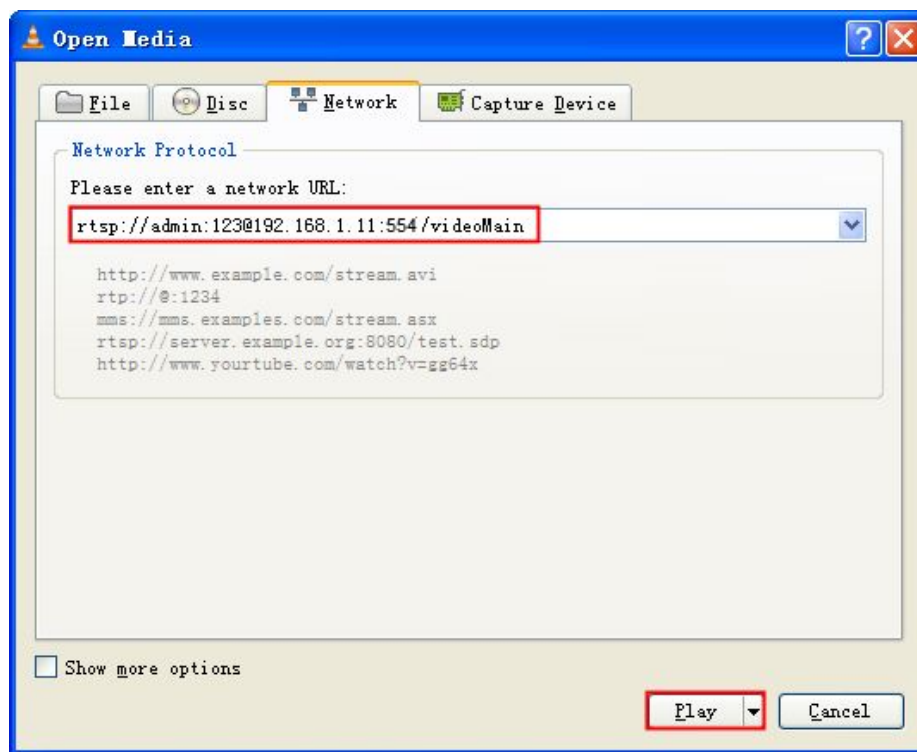
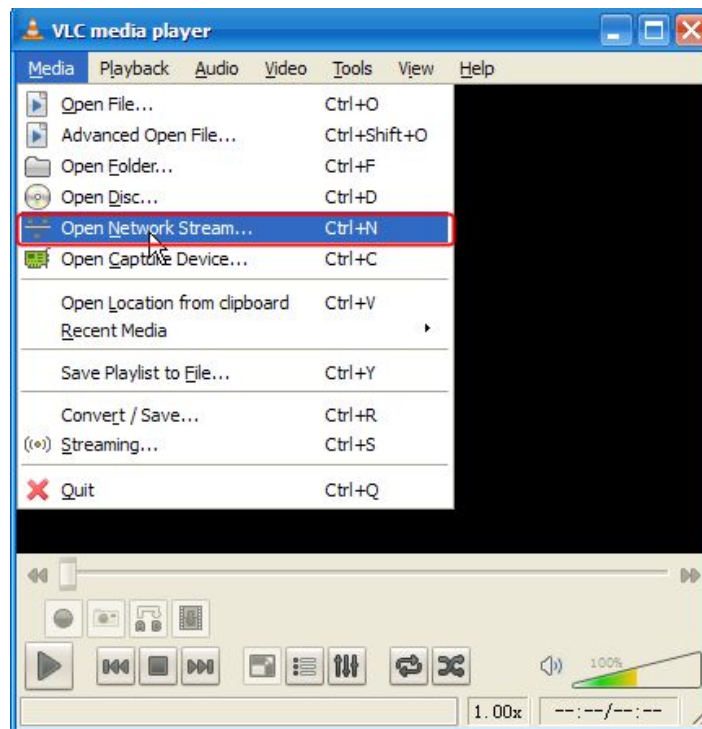

Sometimes you may need to enter the user name and password for another time. Click OK and you can see the real-time preview.

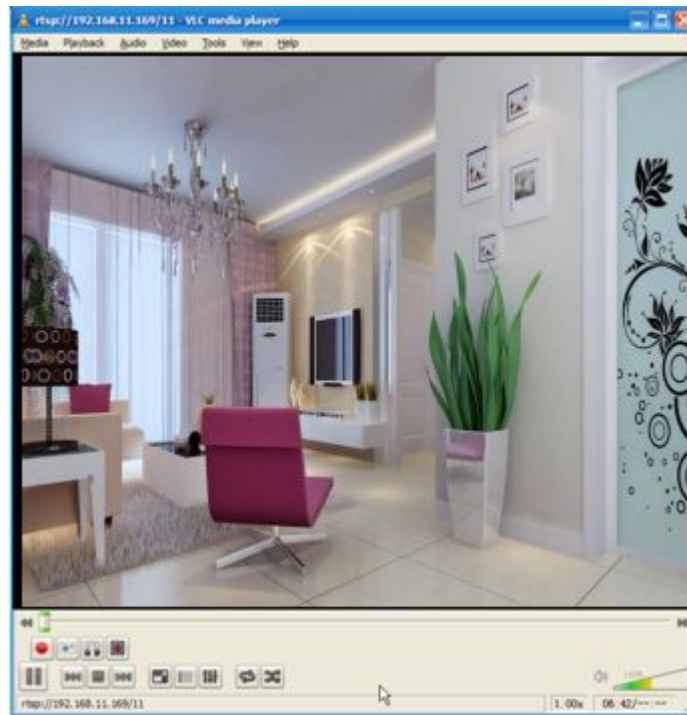

If you cannot play the video in the VLC player, please check the port mapping. You can read Quick Installation Guide about how to configure port forwarding.

#### **NOTE:**

If you modify the camera's username or password, you had better reboot the camera to apply the new username and password in authentication in the VLC.

## **2.5 IP camera connection to the server**

Device supports ONVIF 2.2.1 protocol, You can easily access NVR with ONVIF or server with ONVIF.

## **3 Surveillance Software GUI**

Please refer to the section 2.1 if you install the camera for the first time. You can start to learn about software operation in the computer

## 3.1 login Window

### Section1 Enter the Username and password

The default administrator username is “admin” with no password, please change the password the first time you use and prevent unauthorized users login the camera.

### Section2 Stream

The camera supports two stream modes: Main stream and sub stream. Select Main stream if you want to access the camera from LAN and sub stream will be better if you want to access the camera from Internet.

#### Note:

Select sub stream to ensure a more fluent video under narrow network bandwidth.

### Section3 Select the language

You click on the language dropdown list to select language.

### Section4 login the camera

Click “login” button.

#### NOTE:

When setting up your camera for the first time, it will request that you modify the default username and/or password if both are still set to default. Input the new username and password, click "Modify" to complete the modification. You will now use the new username and password to login to the camera in the future.

Username

New username

New password

Security Level

Confirm the password

**Modify**

### 3.2 Setup Wizard

You will go to “Setup Wizard” automatically after your first-login, where you can set the basic parameters of camera, such as camera name, camera time, wireless settings, IP configuration.

**Setup Wizard**

Setup Wizard - Start

Follow the guide to set your camera, click "Next" to start.

Please click the menu on the left for more settings.

**Next**

**Step 1 of 5 - Soft AP Password Settings**

SSID	C1_1010BD
Encryption	WPA/WPA2
Password	<input type="password"/>
Security Level	<input type="text"/>
Confirm the password	<input type="password"/>

**Previous** **Next**

## Setup Wizard

### Step 2 of 5 - Camera Name

Camera Name

C1

Device Name The maximum length is 20, support Simplified Chinese, English, numbers, letters and symbols \_ -

Previous

Next

## Setup Wizard

### Step 3 of 5 - Camera Time

Time Zone

(GMT) Greenwich mean time; London, Lisbon,

Sync with NTP server

NTP Server

time.nist.gov

Device Time

2014-5-15

03

:

09

:

29

AM

Sync with PC/Terminal

Date Format

YYYY-MM-DD

Time Format

12-hour

Previous

Next

## Setup Wizard

### Step 4 of 5 - Wireless Settings

#### Wireless Network List

Scan

SSID(Network Name)	Encryption	Quality
TP-LINK_21	WPA/WPA2	
TP-LINK_NVR	WPA2	
TP-LINK_C272	Unencrypt	
FOSCAM-docdev	WPA/WPA2	

2

SSID FOSCAM-docdev

Encryption WPA/WPA2

Password ●●●●●●●●

3

The maximum password length is 63, including numbers, letters and symbols



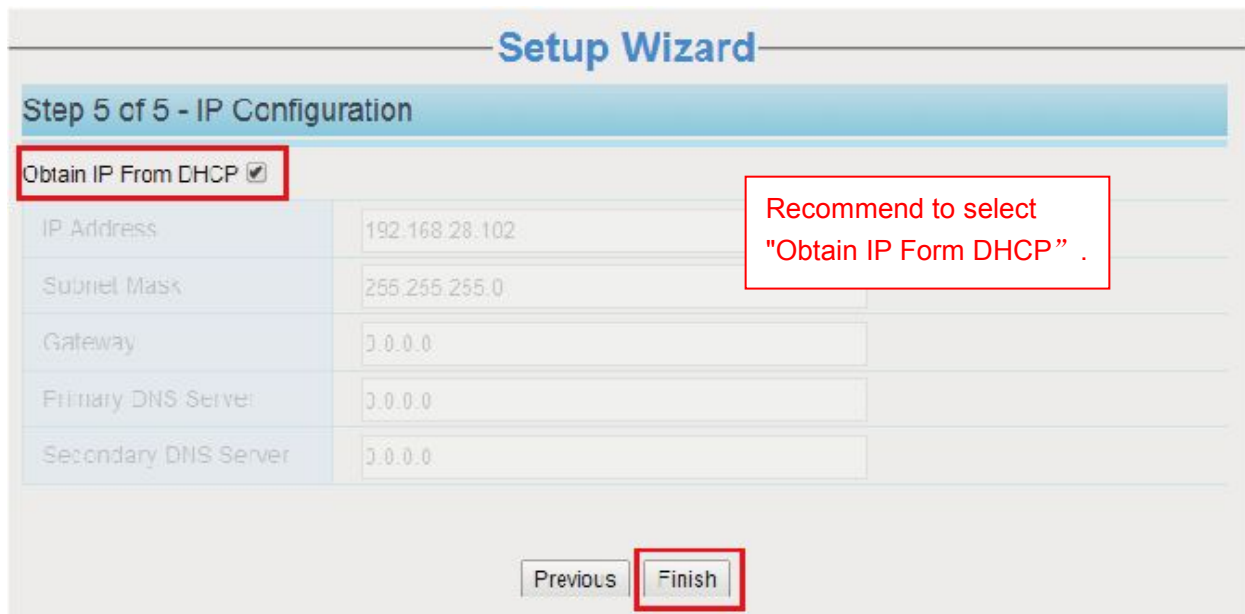

### 3.3 Surveillance Window

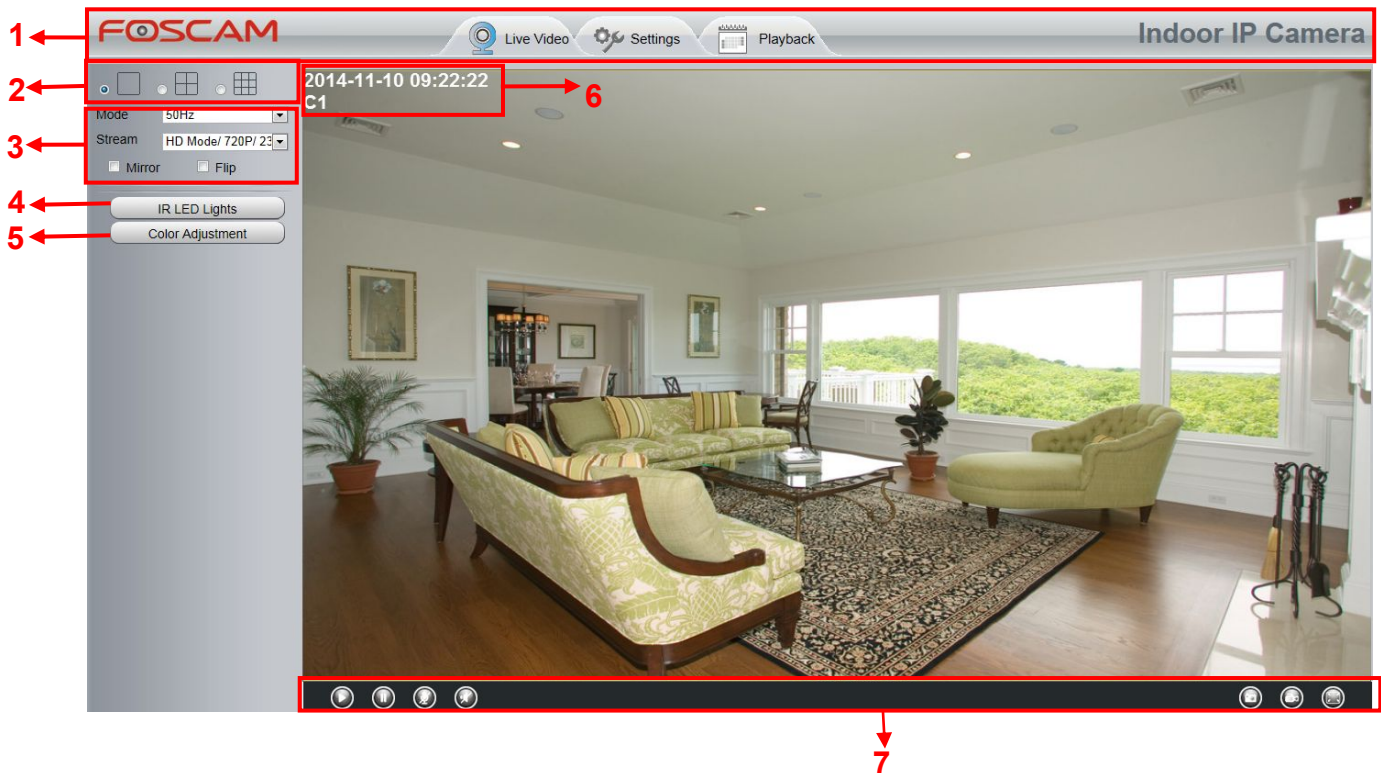

#### Section 1 FOSCAM Logo/ Live Video / Settings/Playback buttons

**FOSCAM**: FOSCAM LOGO

**LiveVideo**: Path to surveillance window. Click this button to go back to the surveillance window

**Settings**: Path to Administrator Control Panel, Click it, to go to Administrator Control Panel and do

advanced settings.



: Click this button to go back to the Playback panel to view the stored audio files stored in the SD Card.

## Section 2 Multi-Device Window



The firmware inside the camera supports up to 9 cameras being monitored at the same time. You can add other cameras in multi-device setting.

## Section 3 Mode/ Stream / Mirror/ Flip buttons

### Mode

- 1) 50HZ -----Indoor surveillance (Region: Europe, China)
- 2) 60HZ -----Indoor surveillance (Region: USA, Canada)
- 3) Outdoor-----Outdoor surveillance

### Stream

The default stream supports multiple modes, For example: HD Mode/720P/23fps/2M meanings: Stream type / Resolution / Maximum frame rate/ Bit rate. (Different models support different specific mode. )

**1) Stream type** : It is used to identify the stream type.

#### 2) 720P/ VGA

There are two resolutions, the bigger one is 720P, and the smaller one (VGA) is 640x480 pixels. The bigger the resolution, the better of the image quality is. If you are accessing the camera via internet and want to get more fluent video streaming, please select resolution VGA.

#### 3) Maximum frame rate

You should lower frame rate when the bandwidth is limited. Normally, when the frame rate above 15, you can achieve fluently video. The maximum frame rate for each model is different, please see the "Specifications".

#### 4) Bit rate

Generally speaking, the larger the bit rate is, the clearer video will become. But the bit rate configuration should combine well with the network bandwidth. When the bandwidth is very narrow, and bit rate is large, that will lead to video can not play well.

You can reset the stream type on **Settings-> Video-> Video Settings** panel.



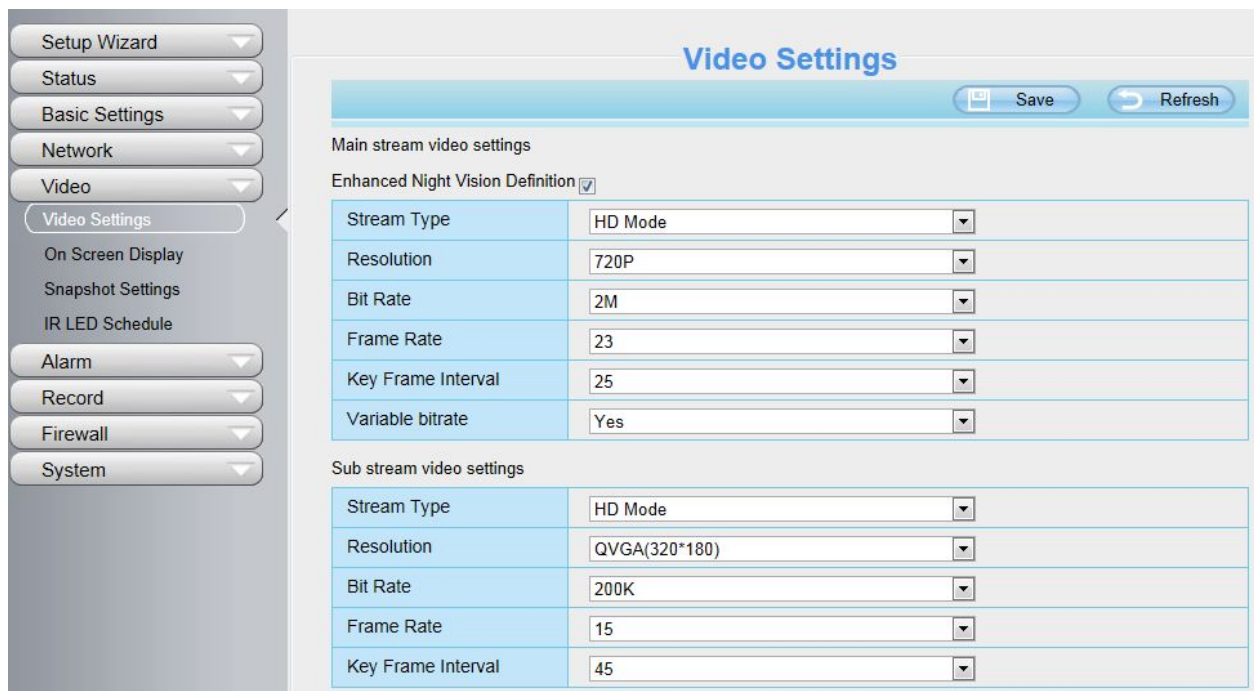

After changing, please reboot the camera and you can see the modification.

## Section 4 IR LED Lights



Click Infra led and there are three modes to adjust the infrared led: Auto, Manual and Schedule.

**Auto:** Select it and the camera will adjust the infra led (on or off) automatically.

**Manual:** Select it and you can turn on or turn off the infra led manually.

**Schedule:** Select it and the IR led light will be off at the schedule period. If you want to define or change the IR led lights schedule time, please go to **Settings**--->**Video**---> **IR LED Schedule** page.

## Section 5 Image quality settings

In this page, you can tune Hue, Brightness, Contrast, Saturation, and Sharpness to get higher quality.



## Section 6 OSD

If you have added time and camera name in the video, you can see it in the live window.

Go to **Settings ---Basic settings---Camera name** panel, and you can change another device name. The default device name is anonymous.

Go to **Settings ---Basic settings---Camera time** panel and adjust the device time.

Go to **Settings ---Video---On Screen Display** panel, you can add or no add OSD.

## Section 7 Play/Stop/ Talk/Audio/ Snap/ Record/ Full screen button



**1----- Play** Click it to play the video of the camera

**2----- Stop** Click it to stop the video of the camera

**3----- Talk** Click the button and the icon will become to , then talk to the microphone that connected with PC, people around the camera can here your voice. Click the icon again and stop talking.

**4----- Audio** Click this icon, the icon will become to  you can hear the sound around the camera by the earphone or speakers that connected with PC.

**5----- Snapshot** Click it to make snapshot and it pop-up a window which picture you snapshot, right click in the window and save the picture to anywhere you want.

**6----- Record** Click the icon  and the camera start recording, you can see a green dot in the live window. Click again and stop recording. The default storage path is C:\IPCamRecord. You can change the storage path: Go to Settings- >Record->Storage Location panel.

**7----- Full Screen** Click it to make full-screen, or you can double click the surveillance screen to make full-screen. Double click again and exit full-screen.

## Onscreen Mouse Control

Right click the mouse and you can adjust the screen ration, full screen and Zoom up.

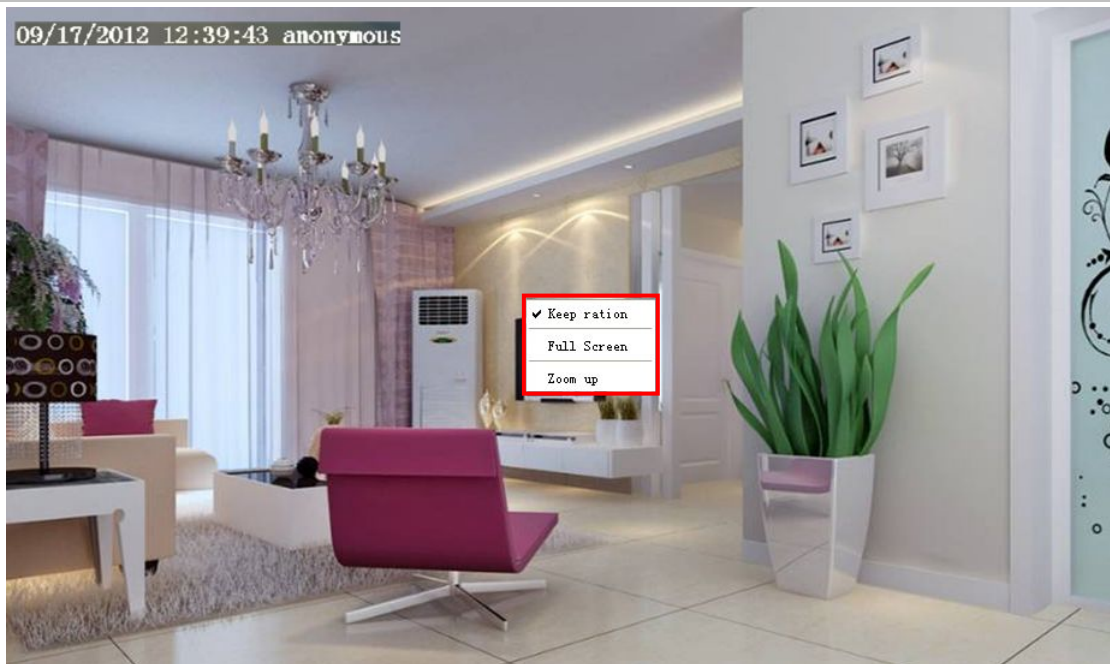

**Keep ration:** Select it and the camera will adjust the size of live window based on the the computer monitor automatically. Sometimes there is a black border around the video, please select Keep ration to get a better visual quality .

**Full Screen:** Select it and Click it to make full-screen, press ESC and exit full-screen.

**Zoom up:** Select it and you can see a bigger screen than before.

**First Method:** Here is a convenient and fast solution to Zoom up/down screen by Clicking Video Screen and adjusting Mouse pulley, or by press the CTRL key and click the mouse left button.

**Second Method:** Click it and the live view will be digital zoomed up, then click Zoom Down and the live view back to original size.

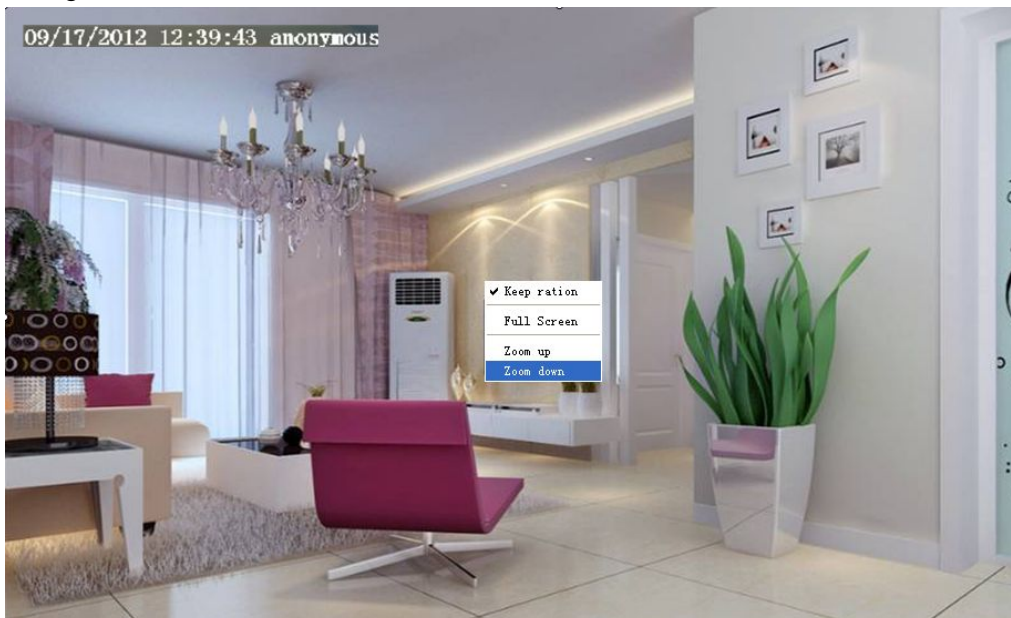

When you select the Full Screen, then click right mouse, there is a Screen PTZ button.

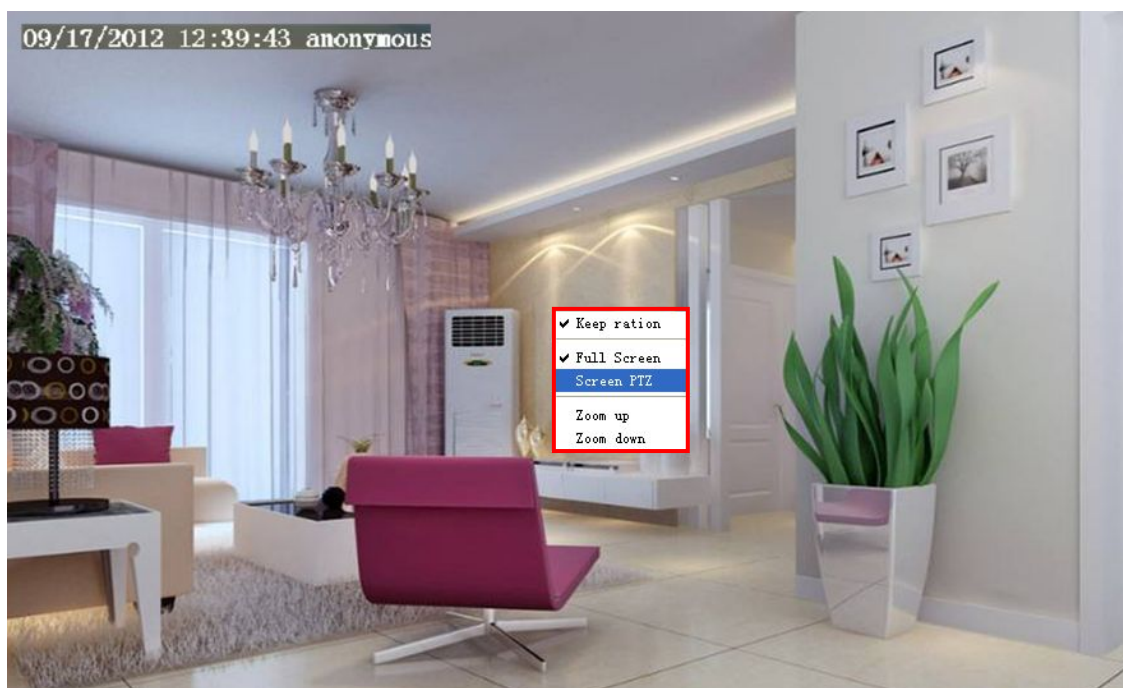

Click the **Screen PTZ** button and put the mouse on the screen to indicate the camera move direction you prefer, press the left mouse, the camera will move to the corresponding direction. Loosen the mouse and stop moving. Press Esc button or double click right mouse and cancel the function.

**NOTE:** For Mac OS, the plugin cannot support Onscreen Mouse Control, so you cannot allow to use it.

## 4 Advanced Camera Settings

Click the button "**Settings**", goes to Administrator Control Panel to make advanced camera settings.

### 4.1 Setup Wizard

Please go to section 3.2 to find the way to set it.

### 4.2 Status

Status contains four columns: Device Information, Device Status, Session Status and Log, it will show you various information about your camera.

## 4.2.1 Device Information

Device Information	
Refresh	
Camera Model	C1
Camera Name	C1
Camera ID	0ABC0BBA5302
Camera Time	2014/11/03 12:01:49
System Firmware Version	1.9.1.11
Application Firmware Version	2.52.1.29
Plug-In Version	3.1.0.5

**Camera Model:** The camera model NO.

**Camera Name:** The Device Name is a unique name that you can give to your device to help you identify it. Click **Basic Settings** and go to **Camera name** panel where you can change your camera name. The default device name is anonymous.

**Camera ID:** Display the wired MAC address of your camera. For example Device ID is 000C5D00008, the same MAC ID sticker is found at the bottom of the camera.

**Camera Time:** The system time of the device. Click **Basic Settings** and go to **Camera time** panel and adjust the time.

**System Firmware Version:** Display the System Firmware version of your camera.

**Application Firmware Version:** Display the application firmware version of your camera.

**Plug-In Version:** Display the plug-in version of your camera.

## 4.2.2 Device Status

On this page you can see device status such as Alarm status/ Record Status ,DDNS status ,WIFI status and so on.



Device Status	
 Refresh	
Alarm Status	Disabled
Recording Status	Not Recording
SD Card Status	No SD card
SD Card Free Space	0KB
SD Card Total Space	0KB
NTP Status	Failed
DDNS Status	Disabled
UPnP Status	Disabled
WiFi Status	Not connected
IR LED Status	Off

### 4.2.3 Session Status

Session status will display who and which IP is visiting the camera now.

Session Status	
 Refresh	
Username	IP Address
1	172.16.8.115

### 4.2.4 Log

The log record shows who and which IP address accessed or logout the camera.

Pages:83				
Refresh				
<< 1 2 3 >> <input type="text"/> Go				
NO.	Time	User	IP	Log
1	2012-09-18 02:11:45			
2	2012-09-18 01:48:56			
3	2012-09-18 01:29:51	admin	192.168.1.102	Log out
4	2012-09-18 01:27:54	admin	218.17.160.187	Log out
5	2012-09-18 01:26:21	admin	192.168.1.100	Log out
6	2012-09-18 01:25:42	admin	218.17.160.187	Login
7	2012-09-18 01:25:15	admin	192.168.1.102	Login
8	2012-09-18 01:25:13	admin	192.168.1.102	Log out
9	2012-09-18 01:24:46	admin	192.168.1.100	Login
10	2012-09-18 01:21:44	admin	192.168.1.102	Login

Reboot the camera and clear the log records.

## 4.3 Basic Settings

This section allows you to configure your camera's Name, Time, Mail, User account and Multi-Device.

### 4.3.1 Camera Name

You can define a name for your camera here such as apple. Click Save to save your changes. The alias name cannot contain special characters.

### Camera Name

Camera Name	<input style="width: 90%;" type="text" value="C1"/> <small>The maximum Device Name length is 20, support English, numbers, letters and symbols</small>
-------------	-----------------------------------------------------------------------------------------------------------------------------------------------------------

### 4.3.2 Camera Time

This section allows you to configure the settings of the internal system clocks for your camera.

<input type="button" value="Save"/> <input type="button" value="Refresh"/>	
Time Zone	(GMT) Greenwich mean time; London, Lisbon, C
Sync with NTP server	<input type="checkbox"/>
NTP Server	time.nist.gov
PC Time	2013-11-13    08 : 20 : 44 AM <input type="button" value="Sync with PC"/>
Date Format	YYYY-MM-DD
Time Format	12-hour
use DST	<input checked="" type="checkbox"/>
Ahead Of Time	0 Minute

**Time Zone:** Select the time zone for your region from the dropdown menu.

**Sync with NTP server:** Network Time Protocol will synchronize your camera with an Internet time server. Choose the one that is closest to your camera.

**Sync with PC:** Select this option to synchronize the date and time of the Network Camera with your computer.

**Manually:** The administrator can enter the date and time manually. Note select the date and time format.

**use DST:** Select the daylight saving time from the dropdown list.

Click **Save** button and submit your settings.

**NOTE:** If the power supply of camera is disconnect, you need set the camera's time again.

### 4.3.3 User Accounts

Here you can create users and set privilege, **visitor**, **operator** or **administrator**. The default user account is admin, with a blank password. You can enter the users accounts of visitor, operator and administrator Manually.



### User Accounts

Refresh

NO.	Username	Privilege
1	1	Administrator
2		
3		
4		
5		
6		
7		
8		

Username   
 Privilege 
  
 Change username  
 Change password

The maximum username length is 20, including numbers, letters and symbols \_ - @ \$ \*  
 The maximum password length is 12, including numbers, letters and symbols ~ ! @ # % ^ \* ( ) \_ + { } : " | < > ? ` - ; ' \ , . /

## How to change the password?

Firstly, select the account which you want to change the password, then select "Change password", enter the old password and the new password, lastly click modify to take effect.

### User Accounts

Refresh

NO.	Username	Privilege
1	foscam	Administrator
2	admin	Administrator
3		
4		
5		
6		
7		
8		

Username   
 Password   
 New username   
 New password   
 Password Security Level   
 Confirm the password   
 Privilege 
  
 Change username  
 Change password

The maximum length of the user name is 20, support numbers, letters and symbols \_ - @ \$ \*  
 The maximum password length is 12, does not support the character & = \$

## How to add account ?

Select one blank column, then enter the new user name, password and privilege, last click Add to take effect. You can see the new added account on the Account list.

### User Accounts

Refresh

NO.	Username	Privilege
1	foscam	Administrator
2	admin	Administrator
3		
4		
5		
6		
7		
8		

Username:   
 Password:   
 Password Security Level: Low security level.  
 Confirm the password:   
 Privilege:

Change username  
 Change password

Add

The maximum length of the user name is 20, support numbers, letters and symbols \_ - @ \$ \*  
 The maximum password length is 12, does not support the character & = \$

### User Accounts

Refresh

NO.	Username	Privilege
1	foscam	Administrator
2	admin	Administrator
3	user	Administrator
4		
5		
6		
7		
8		

Username:   
 Privilege:

Change username  
 Change password

Delete

The maximum length of the user name is 20, support numbers, letters and symbols \_ - @ \$ \*  
 The maximum password length is 12, does not support the character & = \$

**Delete** : Select the account which you want to delete, then click Delete button to take effect.

**NOTE:** The default admin account cannot be deleted, but you can add other administrator users.

## How to change the username ?

Firstly, select the account which you want to change the username, then select "Change username", enter the new password, lastly click modify to take effect.

**User Accounts** Refresh

NO.	Username	Privilege
1	admin	Administrator
2	operator	Operator
3		
4		
5		
6		
7		
8		

Username:

New username:

Privilege:

Change username

Change password

The maximum length of the user name is 20, support numbers, letters and symbols \_ - @\$\*

The maximum password length is 12, does not support the character & =

### 4.3.4 Multi-Camera

If you want to view multi-surveillance screens on one window, you need to login one camera, and set it as the main device, and do Multi-Device Settings, add other cameras to the first one camera. Before you do multi-cams settings, you need to assign different port such as 81, 82, 83, 84, 85, 86, 87, 88 to the cameras if there is 8 cams installed.

The firmware within the camera can support a maximum of 9 devices monitoring all at the same time. This page you can both add FOSCAM MJPEG and H.264 series cameras to the first camera and view multi-surveillance screen on one window.

#### Add cameras in LAN

In Multi-Device Settings page, you can see all devices searched in LAN. The 1st Device is the default one. You can add more cameras in the list in LAN for monitoring. The camera's software supports up to 9 IP Cameras online simultaneously. Click The 2nd Device and click the item in the Device List in LAN, the Alias, Host and Http Port will be filled in the boxes below automatically. Enter the correct username and password then click Add. Add more cameras in the same way.

### Multi-Camera

Cameras On LAN	FI9821P(172.16.0.94) 1111(172.16.1.71) FOSCAM(172.16.0.27) <b>anonymous(172.16.0.179)</b> FOSCAM(172.16.0.105)	<input type="button" value="Refresh"/>
The 1st Camera	This Camera	
<a href="#">The 2nd Camera</a>	None	
Camera Model	<input type="text" value="H264"/>	
Camera Name	<input type="text" value="anonymous"/>	
Host	<input type="text" value="172.16.0.179"/>	
HTTP Port	<input type="text" value="80"/>	
Media Port	<input type="text" value="80"/>	
Username	<input type="text" value="admin"/>	
Password	<input type="password"/>	
	<input type="button" value="Add"/>	<input type="button" value="Delete"/>
<a href="#">The 3rd Camera</a>	None	
<a href="#">The 4th Camera</a>	None	

**1 Click it, camera model, alias, host and HTTP Port will be filled in the following boxes automatically.**

**2 Enter the User name and password of the 2nd camera.**

**3 Click Add to take effect.**

**Camera Model:** Our Company produces two series cameras: MJPEG and H.264. Here will show you which series the camera belongs to.

Cameras On LAN	anonymous(192.168.11.193) FI9821W for ebuyer (192.168.11.241) <b>anonymous(192.168.11.203)</b> anonymous(192.168.11.243)	<input type="button" value="Refresh"/>
The 1st Camera	This Camera	
<a href="#">The 2nd Camera</a>	anonymous(192.168.11.203)	
<a href="#">The 3rd Camera</a>	FI9821W for ebuyer (192.168.11.241)	
<a href="#">The 4th Camera</a>	anonymous(192.168.11.203)	
<a href="#">The 5th Camera</a>	None	
<a href="#">The 6th Camera</a>	None	
<a href="#">The 7th Camera</a>	None	
<a href="#">The 8th Camera</a>	None	
<a href="#">The 9th Camera</a>	None	

Note: If you want to access your camera remotely, make sure you are able to access it seperately through a browser.



Back to **Surveillance Windows**, and click Four Windows option, you will see four cameras you added.

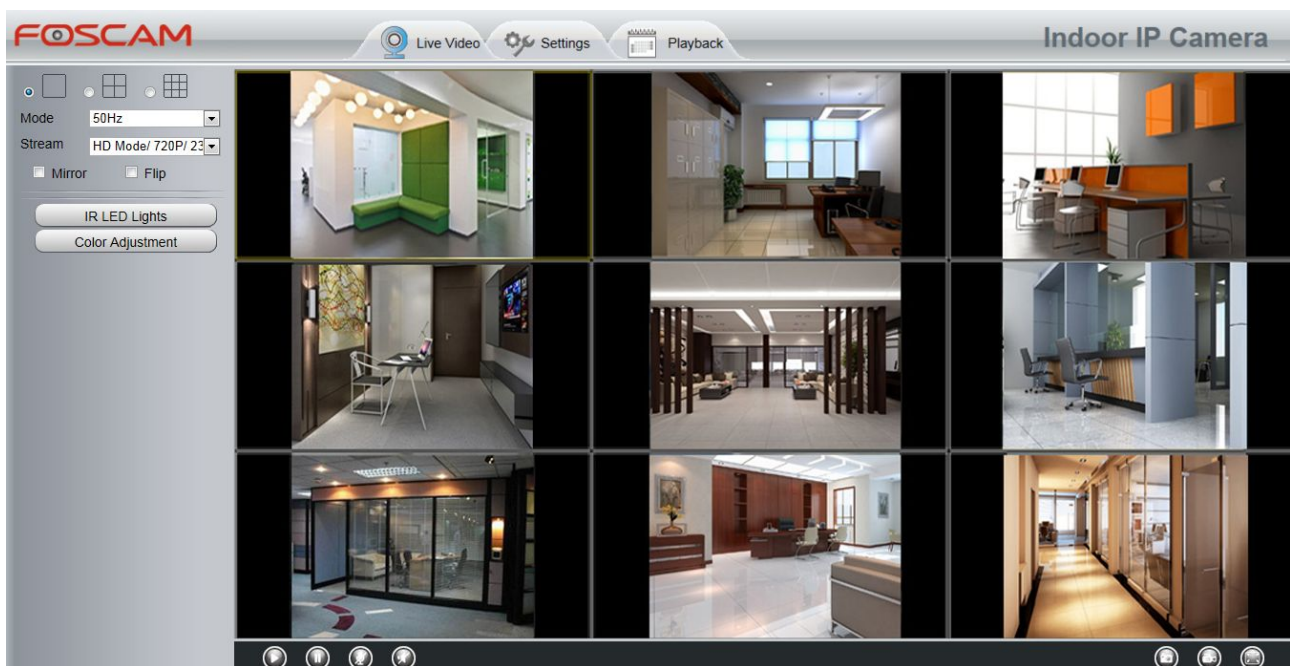
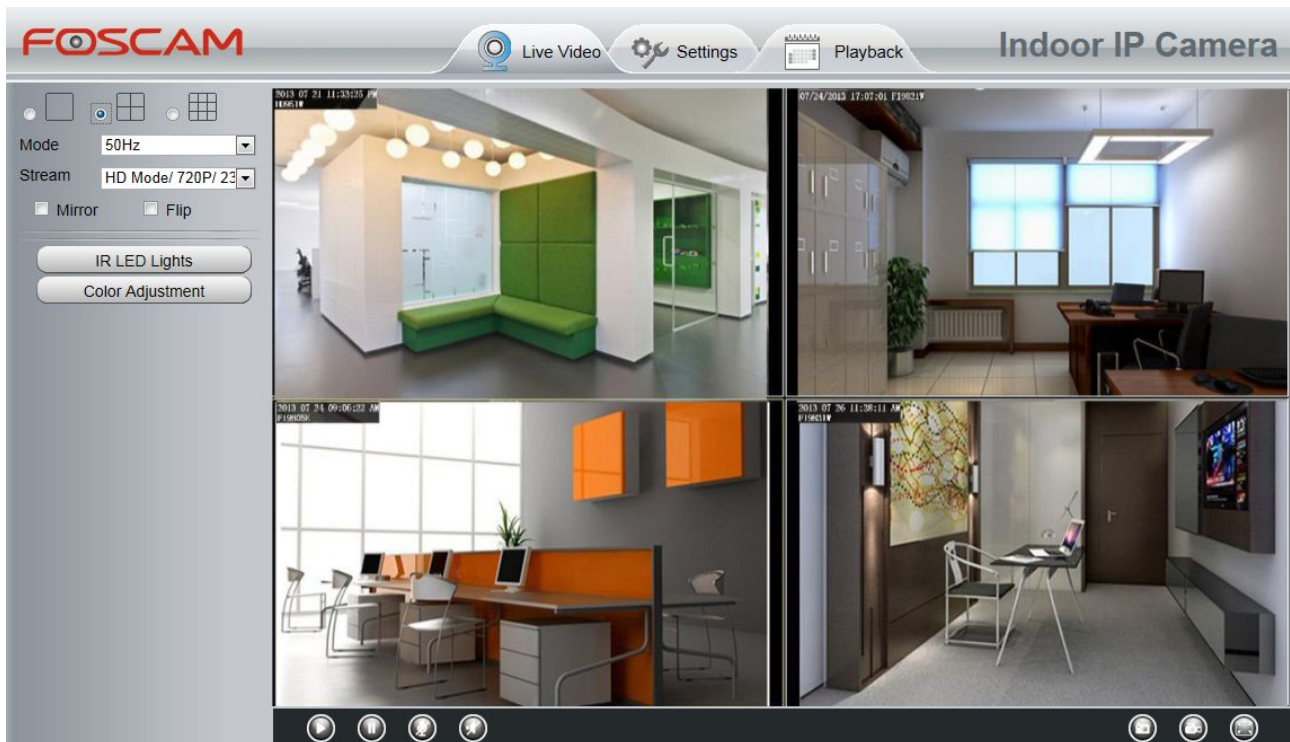

## Add cameras in WAN

If you want to view all cameras via the internet(remote computer), you will need to add them using DDNS domain name. Firstly, make sure all of the cameras you added can be accessed through the internet.

**(The way to configure DDNS is in chapter 4.4.4)**

Login to the first camera using a DDNS domain name and port.

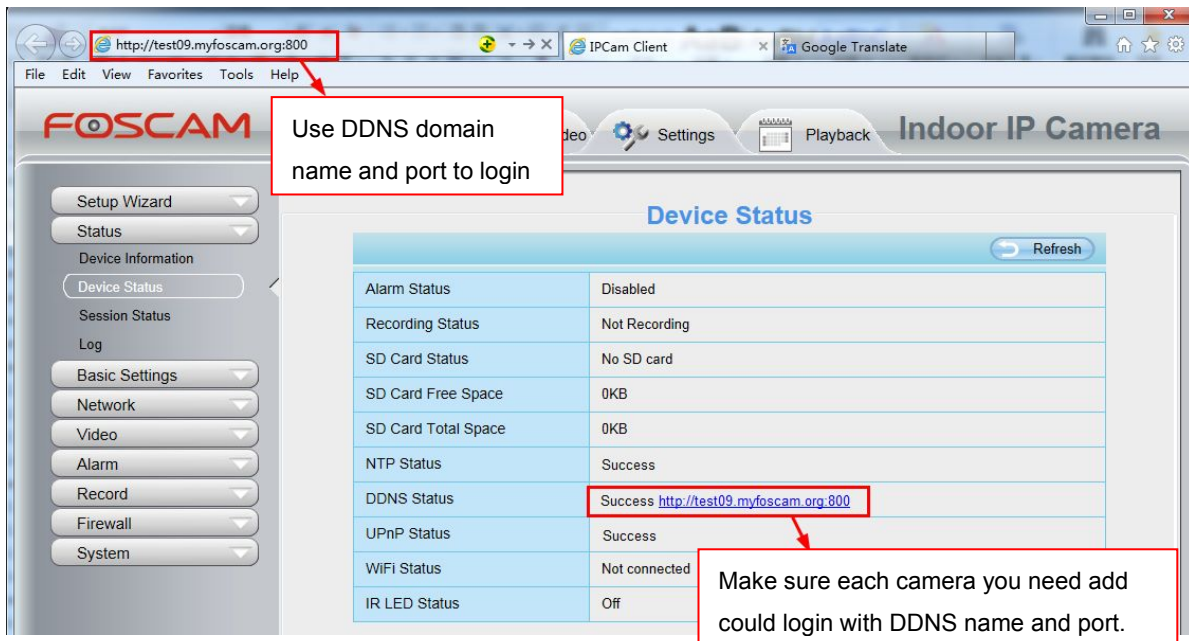

Click **Multi-Device Settings**. Choose **The 2nd Device**. Fill in the 2nd camera's name, DDNS domain name, port number. Enter user name and password and then choose Add.

The 1st Camera	This Camera
<a href="#">The 2nd Camera</a>	F19821W(172.16.0.47)
Camera Model	H264 <span style="float: right;">1</span>
Camera Name	F19821W <span style="float: right;">2</span>
Host	172.16.0.47
HTTP Port	88 <span style="float: right;">3</span>
Media Port	88
Username	admin <span style="float: right;">4</span>
Password	<input type="password"/>
<span style="float: left;">5</span> <input type="button" value="Add"/> <input type="button" value="Delete"/>	

- 1 ---- The camera model: MJ or H264.
- 2 ---- The 2nd camera's name
- 3 ---- Fill in the 2nd camera's DDNS host not LAN IP

**NOTE:** The MJ series have the same HTTP Port NO. and Media Port NO.

- 4 ---- Enter the 2nd camera's user name and password
- 5 ---- Click Add button and to take effect

**NOTE:** Here the Host must be entered as the second camera's DDNS domain name, not its LAN IP.

Cameras On LAN	
	anonymous(192.168.11.193) F19821W for ebuyer (192.168.11.241) <b>anonymous(192.168.11.203)</b> anonymous(192.168.11.243)
	<input type="button" value="Refresh"/>
<a href="#">The 1st Camera</a>	This Camera
<a href="#">The 2nd Camera</a>	F19821W(172.16.0.47)
<a href="#">The 3rd Camera</a>	F19821W for ebuyer (192.168.11.241)
<a href="#">The 4th Camera</a>	anonymous(192.168.11.203)
<a href="#">The 5th Camera</a>	None
<a href="#">The 6th Camera</a>	None
<a href="#">The 7th Camera</a>	None
<a href="#">The 8th Camera</a>	None
<a href="#">The 9th Camera</a>	None

Note: If you want to LAN to access your camera remotely, make sure you are able to access it separately through a browser.

Return to video window. You will see all of the cameras accessible through the internet. When you are away from home, you can use the first camera's DDNS domain name and port to view all the cameras via internet.

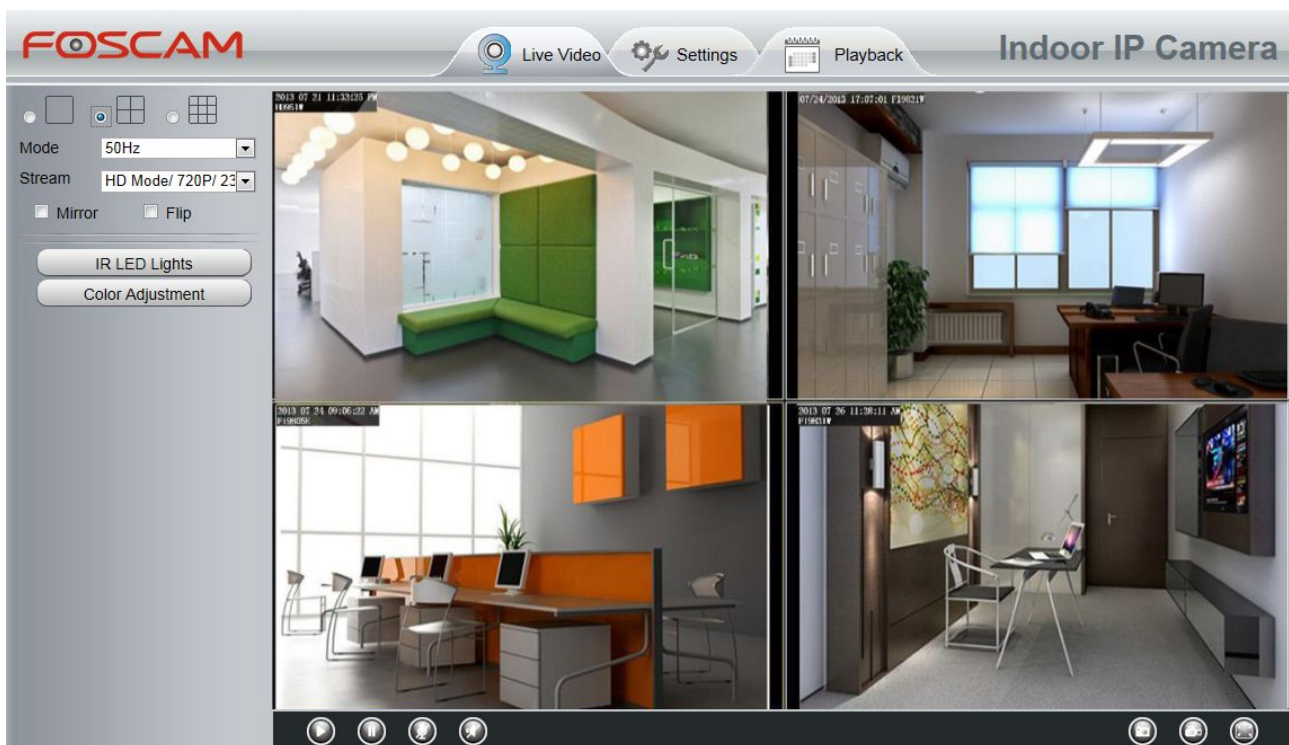

### 4.3.5 Status Light

You can enable or disable status light.

## Status Light

<b>Enable Status Light</b>	Yes <input type="button" value="v"/>
----------------------------	--------------------------------------

## 4.4 Network

This section will allow you to configure your camera's IP, DDNS, Wireless Settings, UPnP and Port.

### 4.4.1 IP Configuration

If you want to set a static IP for the camera, please go to **IP Configuration** page. Keep the camera in the same subnet of your router or computer.

Obtain IP From DHCP

IP Address	<input type="text" value="192.168.0.109"/>
Subnet Mask	<input type="text" value="255.255.255.0"/>
Gateway	<input type="text" value="192.168.0.1"/>
Primary DNS Server	<input type="text" value="192.168.0.1"/>
Secondary DNS Server	<input type="text" value="202.96.134.133"/>

Note: Once you save your settings, the camera will restart.

Changing settings here is the same as using the IP Camera Tool.

It is recommended that you use the subnet mask, gateway and DNS server from your locally attached PC. If you don't know the subnet mask, gateway and DNS server, you can check your computer's local area connection as follows:

**Control Panel** → **Network Connections** → **Local Area Connections** → **Choose Support** → **Details**



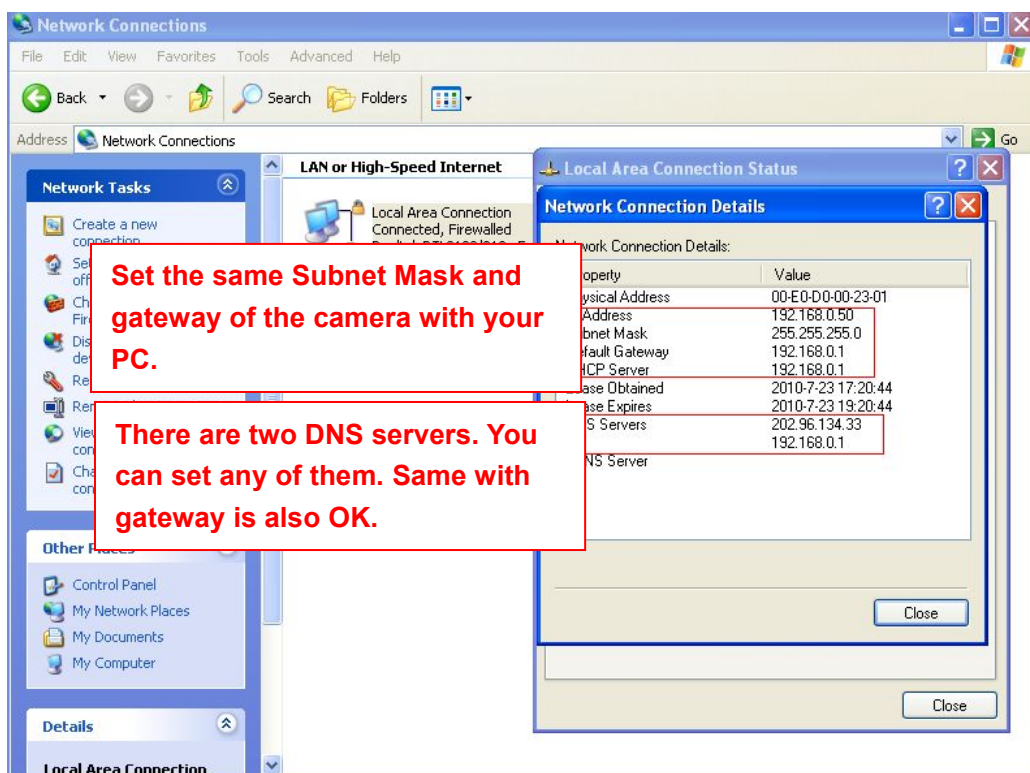
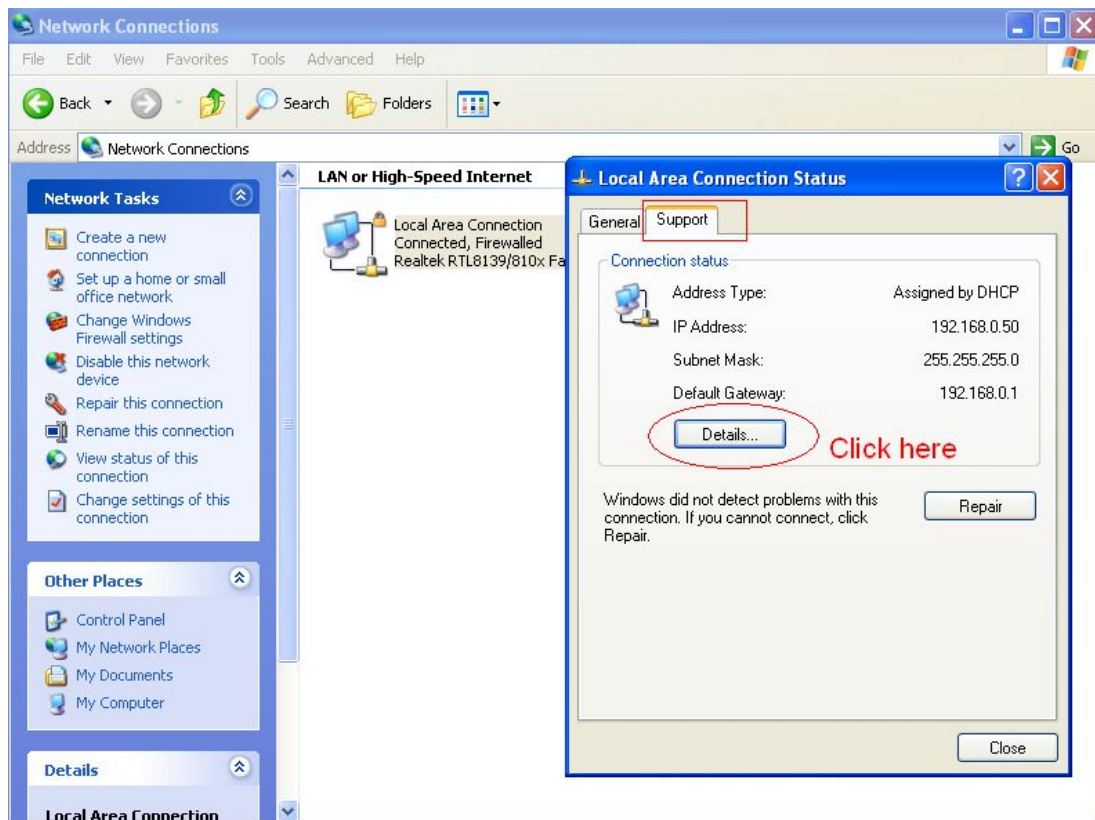

If you don't know the DNS server, you can use the same settings as the Default Gateway.

## 4.4.2 Wireless Settings

**Step 1:** Choose **“Settings”** on the top of the camera interface, and go to the **“Network”** panel on the left side of the screen, then click **“Wireless Settings.”**

Click the **Scan** button and the camera will detect all wireless networks around the area. It should also display your router in the list.

**Wireless Settings**

Save Refresh

**Wireless Network List**

Click the Scan button to search for wireless networks.

SSID(Network Name)	Encryption	Quality
wutingjun	WPA/WPA2	📶
dlink-chenchen2.4G	WPA/WPA2	📶
WEILI	WPA/WPA2	📶
TP-LINK_3B9E4E	WPA/WPA2	📶
TPGuest_E0EE	Unencrypt	📶
TPlink-zf	WPA/WPA2	📶
HUAWEI-DQB	WPA/WPA2	📶
TP-LINK_YF	WPA/WPA2	📶
NETGEAR95	WPA/WPA2	📶
TP-LINK_CB209C	WPA/WPA2	📶

Pages: 4 << 1 2 3 >> Go

The maximum password length is 63, including numbers, letters and symbols ~ ! @ # % ^ \* ( ) \_ + { } : " | < > ? ' - ; ' \ , . /

Click the Page number to see other wireless networks devices if there are more than 10.

**Step 2:** Click the SSID (name of your router) in the list, the corresponding information related to your network, such as the name and the encryption, will be filled into the relevant fields automatically.

You will only need to fill in the password of your network. Make sure that the SSID, Encryption and the password you filled in are exactly the same for your router.

**Wireless Settings**

Save Refresh

**Wireless Network List**

SSID(Network Name)	Encryption	Quality
TP-LINK_B18958	Unencrypt	📶
TP-LINK_llyo	WPA/WPA2	📶
maqb	WPA/WPA2	📶
TP-LINK_YF	WPA/WPA2	📶
Network-9F8700E207022	WPA/WPA2	📶
<b>TP-LINK_51BAB4</b>	<b>WPA/WPA2</b>	<b>📶</b>
TP-LINK_wyy	WPA/WPA2	📶
wjx	Unencrypt	📶
zhwwang_1	WEP	📶
TP-LINK_B2637A	Unencrypt	📶

SSID: TP-LINK\_51BAB4

Encryption: WPA/WPA2

Password:

2 Enter the password of your router.

1 Click the SSID of your router and the relevant information will be filled in the fields automatically.

**Step 3:** Please click on the **Save** button after all settings have been entered and disconnect the network cable. Never shut down the power of the camera until the IP camera is able to connect to the wireless network.

The LAN IP address will disappear on the window of IP Camera Tool when the camera is configuring a wireless connection. Wait about 1 minute, the camera should obtain a wireless connection, and the LAN IP of the camera will show again on the window of the IP Camera Tool. The IP address may have changed after the camera receives a wireless connection; we recommend setting a static local IP address if this IP address changes by right clicking the camera in IP Camera Tools, setting a static IP, and pushing OK.

Congratulations! You have set up the wireless connection of the camera successfully.

#### NOTE :

**If you fail to make a wireless connection, please refer to your seller or contact us directly for assistance.**

### 4.4.3 Soft AP Password Settings

For the safety of your camera, we recommend you change the Soft AP password.

Soft AP Password Settings	
<input type="button" value="Save"/> <input type="button" value="Refresh"/>	
SSID	C1_000001
Encryption	WPA/WPA2
Password	<input type="password" value="....."/>
New password	<input type="password"/>
Security Level	<input type="text"/>
Confirm the password	<input type="password"/>

### 4.4.4 DDNS

FOSCAM camera has embedded a unique DDNS domain name when producing, and you can directly use the domain name, you can also use the third party domain name.

#### FOSCAM domain name

Here take **test09.myfoscam.org** for example. Go to option of DDNS on the **Settings->Network** panel, you can see the domain name.

Save Refresh

Enable DDNS

Manufacturer's DDNS

Manufacturer's DDNS  Restore DDNS to factory

Third Party DDNS

DDNS Server

Domain

Now you can use `http:// Domain name + HTTP Port` to access the camera via internet.

Take hostname **test09.myfoscam.org** and HTTP Port no. 800 for example, the accessing link of the camera via internet would be `http:// test09.myfoscam.org:800`

Device Status	
Alarm Status	Disabled
Recording Status	Not Recording
SD Card Status	No SD card
SD Card Free Space	0KB
SD Card Total Space	0KB
NTP Status	Success
DDNS Status	Success <a href="http://test09.myfoscam.org:800">http://test09.myfoscam.org:800</a>
UPnP Status	Success
WiFi Status	Not connected
IR LED Status	Off

**Restore DDNS to factory:** If you have configured Third Party DDNS successfully, but you want to use Manufacturer's DDNS again, here click this button and start Manufacturer's DDNS Service.

User can also use third part DDNS, such as **www.no-ip.com.** ,**www. 3322.com**

#### 4.4.5 UPnP

Save Refresh

Enable UPnP

The default UPnP status is closed. You can enable UPnP, then the camera's software will be configured for port forwarding. Back to the **"Device Status"** panel, you can see the UPnP status:

Device Status	
Alarm Status	Disabled
Recording Status	Not Recording
SD Card Status	No SD card
SD Card Free Space	0KB
SD Card Total Space	0KB
NTP Status	Success
DDNS Status	Success <a href="http://test09.myfoscam.org:800">http://test09.myfoscam.org:800</a>
UPnP Status	Success
WiFi Status	Not connected
IR LED Status	Off

The camera's software will be configured for port forwarding. There may be issues with your routers security settings, and sometimes may error. We recommend you configure port forwarding manually on your router.

#### 4.4.6 Port

This camera supports HTTP Port. HTTP Port is used to access the camera remotely. If you want to access the camera and view the video, the HTTP Port must both be configured correctly.

**HTTP port:** By default, the HTTP is set to 88. Also, they can be assigned with another port number between 1 and 65535. But make sure they can not be conflict with other existing ports like 25, 21.

Port	
HTTP Port	88
HTTPS Port	443
ONVIF Port	888
RTSP port	554

**ONVIF port:** By default, the ONVIF port is set to 888. Also, they can be assigned with another port number between 1 and 65535(except 0 and 65534). But make sure they can not be conflict with other existing ports.

**HTTPS port:** The default port is 443. You can use the url to access the camera: **https:// IP + HTTPS port.**

**RTSP port:** The default port is 554. Only some IP Cameras have RTSP port.

#### Another way to change the HTTP port NO.

Step 1: Open the IP Camera Tool, select the camera you would like to change the port of, right click on



the IP address, and click on "Network Configuration", this brings up the network configuration box as flowing figures.

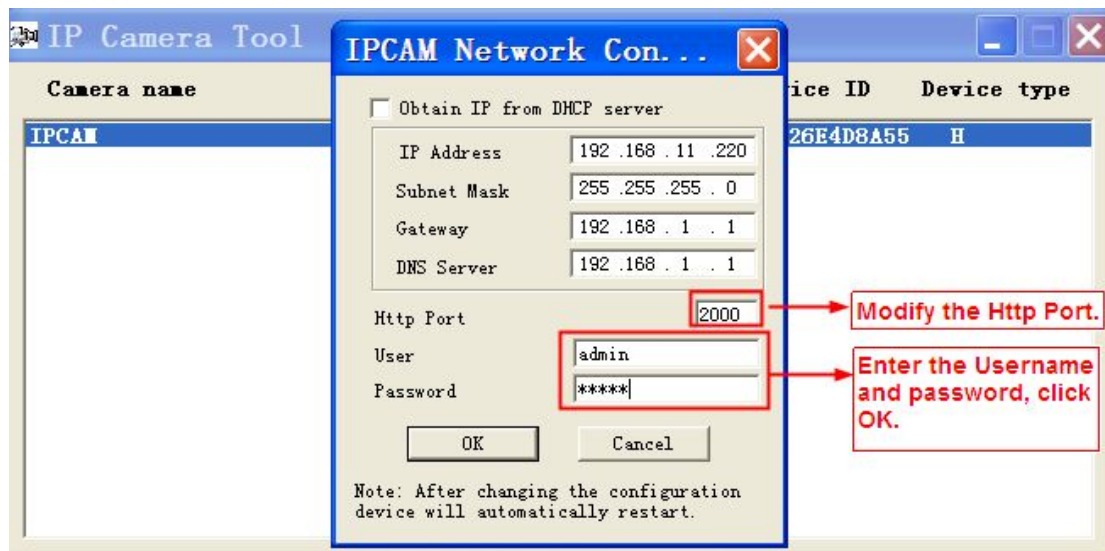
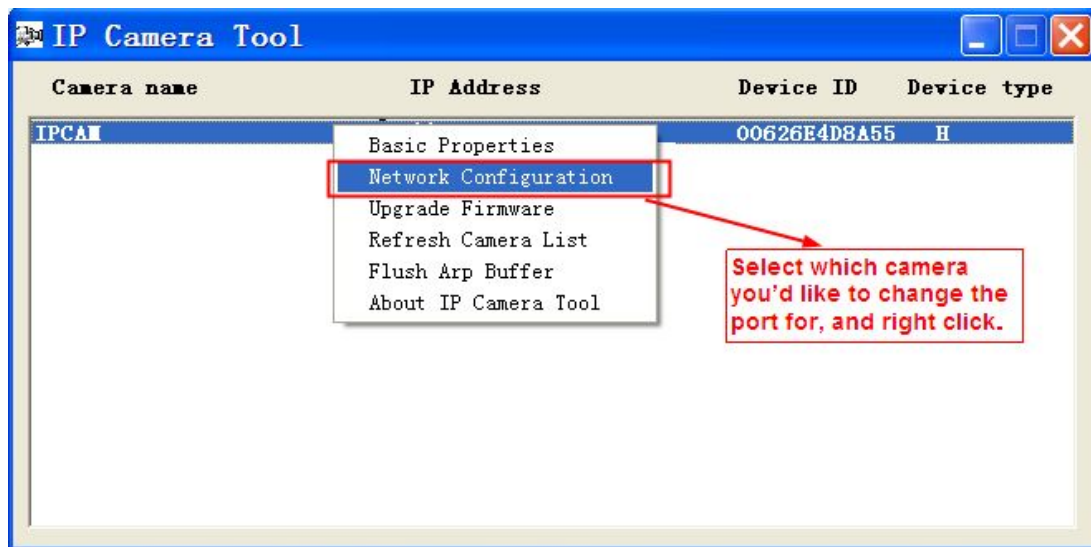

**Step 2:** Enter the username and password of the Administrator (default username is admin with a blank password), and click "OK" to apply changes.

**Step 3:** Wait around 10 seconds, you'll see that the camera's LAN IP address has changed. In our example it was changed to 2000, so we see http://192.168.8.102:2000 in IP Camera Tool. Also, the LAN IP address is now fixed at a static IP address of http://192.168.8.102:2000. This IP address will not change even if the camera is powered off and back on, the camera will remain on this LAN IP address. This is very important that a static LAN IP address is set, or you may have problems later with remote access and seeing the camera remotely if the camera loses power and reconnects on a different LAN IP address. Make sure you set a static LAN IP address!



Camera name	IP Address	Device ID	Device type
IPCAM	Http://192.168.11.220:88	00626E4D8A55	H

If the camera cannot be accessed, please make sure the port forwarding is succeed.

#### 4.4.7 Mail Settings

If you want the camera to send emails when motion has been detected, here Mail will need to be configured.

**1---- SMTP Server/ Port /Transport Layer Security** Enter SMTP server for sender. **SMTP** port is usually set as 25. Some SMTP servers have their own port, such as 587 or 465, and Transport Layer Security usually is None. If you use Gmail, Transport Layer Security must be set to TLS or STARTTLS and SMTP Port must be set to 465 or 25 or 587, which port you choose should be decided by which Transport Layer Security you select.

**2---- SMTP Username/ password** ID account and password of the sender email address

**3---- Sender E-mail** Mailbox for sender must support SMTP

**4---- Receiver** Mailbox for receiver need not support SMTP,you can set 4 receivers

**5---- Save** Click Save to take effect

**6---- Test** Click Test to see if Mail has been successfully configured.

Click **Test** to see if Mail has been successfully configured.

Save Refresh	
Enable	<input checked="" type="checkbox"/>
SMTP Server	smtp.gmail.com SMTP server address supports English, numbers and @ _ . -
SMTP Port	25
Transport Layer Security	STARTTLS G-Mail only supports TLS at Port 465 and STARTTLS at Port 587 or 25. Hotmail only supports STARTTLS at Port 587 or 25.
Need Authentication	Yes
SMTP Username	test123@gmai.com The maximum length of the user name is 63, support numbers, letters and symbols @ _ . \$ * -
SMTP Password	..... The maximum password length is 32, does not support the character & =
Sender E-mail	test123@gmai.com <input type="button" value="Test"/> <b>Success</b> <b>Test result.</b>
First Receiver	test@163.com The maximum length of the receiver is 63, support numbers, letters and symbols @ _ . \$ * -
Second Receiver	tset@hotmail.com
Third Receiver	
Fourth Receiver	

If the test success, you can see the Success behind the Test, at the same time the receivers will receive a test mail.

If the test fails with one of the following errors after clicking **Test**, verify that the information you entered is correct and again select Test .

- 1) Cannot connect to the server
- 2) Network Error. Please try later
- 3) Server Error
- 4) Incorrect user or password
- 5) The sender is denied by the server. Maybe the server need to authenticate the user, please check it and try again
- 6) The receiver is denied by the server. Maybe because of the anti-spam privacy of the server
- 7) The message is denied by the server. Maybe because of the anti-spam privacy of the server
- 8) The server does not support the authentication mode used by the device

#### 4.4.8 FTP Settings

If you want to upload record files and images to your FTP server, you can set **FTP Settings**.

Save Refresh	
FTP Server	<input type="text" value="ftp://192.168.8.150"/> Example:ftp://192.168.1.103/dir The maximum length of the address is 127, does not support the character & =
Port	<input type="text" value="21"/>
FTP Mode	PORT
Username	<input type="text" value="yaocuixiang"/> The maximum length of the user name is 63, support numbers, letters and symbols _ @ \$ * - , . # !
Password	<input type="password" value="....."/> The maximum password length is 63, does not support the character & =
<input type="button" value="Test"/>	Success

Figure a

Save Refresh	
FTP server	<input type="text" value="ftp://ftp.mgenseal.com"/> example:ftp://192.168.1.103
Port	<input type="text" value="21"/>
FTP Mode	PORT
User name	<input type="text" value="deotestge"/>
Password	<input type="password" value="....."/>
<input type="button" value="Test"/>	Success

Figure b

**FTP server:** If your FTP server is located on the LAN, you can set as Figure a.

If you have an FTP server which you can access on the internet, you can set as Figure b.

**Port:** Default is port 21. If changed, external FTP client program must change the server connection port accordingly.

**FTP Mode:** Here supports two modes: PORT and PASV.

**Username/password:** The FTP account and password.

Click **Save** to take effect.

Click **Test** to see if FTP has been successfully configured.

#### 4.4.9 P2P

Access the IP Camera by Smart Phone (Android or iOS operating system)

First of all, you must open the P2P function of the IP Camera at "Settings --> Network --> P2P."

P2P	
<input type="button" value="Save"/> <input type="button" value="Refresh"/>	
UID	FLGTBW7YGBUV9NPMUR41
Enable P2P	<input checked="" type="checkbox"/>
P2P Port	29499

Foscam App named **Foscam** on App Store and Google Play for iOS and Android devices.

#### NOTE:

If the QR code scanning is not successful, please input the UID on the bottom of the camera manually.

## 4.5 Video

This section allows you to configure Video stream settings, On screen display and Snapshot settings.

### 4.5.1 Video Settings

There are two ways to set the stream video settings. They are main stream video settings and sub stream video settings.

Video Settings	
<input type="button" value="Save"/> <input type="button" value="Refresh"/>	
Main stream video settings	
Enhanced Night Vision Definition	<input checked="" type="checkbox"/>
Stream Type	HD Mode
Resolution	720P
Bit Rate	2M
Frame Rate	23
Key Frame Interval	20
Variable bitrate	Yes
Sub stream video settings	
Stream Type	HD Mode
Resolution	QVGA(320*180)
Bit Rate	200K
Frame Rate	15
Key Frame Interval	45

**Enhanced Night video Definition:** The camera will automatically drop the frame to extend the recording time in the night.

**Stream Type:** There are four types to identify different streams you have set. If select the HD Mode, the clearer video will become, and it will take up more bandwidth; If select the Smooth Mode, the bandwidth is very narrow, and bit rate is large, that will lead to video can not play well. The Equilibrium Model is a value between HD Mode and Smooth Mode.

**Resolution:** The camera supports multiple types, For example: 960P, 720P, VGA. The higher the resolution is the clearer video will become. But the code flux will become larger too, and it will take up more bandwidth. (The maximum frame rate for each model is different, please see the “Specifications” . )

**Bit Rate:** Generally speaking, the larger the bit rate is, the clearer video will become. But the bit rate configuration should combine well with the network bandwidth. When the bandwidth is very narrow, and bit rate is large, that will lead to video can not play well.

**Frame rate:** You should lower frame rate when the bandwidth is limited. Normally, when the frame rate above 15, you can achieve fluently video.

**Key Frame Interval:** The time between last key frame and next key frame. The shorter the duration, the more likely you will get a better video quality, but at the cost of higher network bandwidth consumption.

**Variable bitrate:** Select the Bit rate type to constant or variable. If select Yes, the camera will change the video bit rate according to the situation, but will not more than the maximum parameter "Bit Rate"; If select No, the Bit Rate is unchanged.

## 4.5.2 On Screen Display

This page is used to add timestamp and device name on the video.

OSD	
<input type="button" value="Save"/> <input type="button" value="Refresh"/>	
Display Timestamp	Yes
Display Camera Name	Yes

### Display Timestamp

There are two options: Yes or NO. Select Yes and you can see the system date on the video.

### Display Camera Name

There are two options: Yes or NO. Select Yes and you can see the device name on the video.

### 4.5.3 Snapshot Settings

On this page you can set the snapshot pictures' image quality and the storage path.

#### Snapshot Settings

Manual snap Quality	Medium
Pictures Save To	None

Enable timing to capture:

Capture interval	2 (1-65535s)
------------------	--------------

Schedule

All	00	01	02	03	04	05	06	07	08	09	10	11	12	13	14	15	16	17	18	19	20	21	22	23
MON																								
TUE																								
WED																								
THU																								
FRI																								
SAT																								
SUN																								

**Manual snap Quality:** Low, Middle and High. The higher the quality, the picture will be clearer.

**Pictures Save To:** FTP or SD card. If you have done FTP and Alarm settings, when alarming, the camera will snap pictures to the FTP or SD card automatically.

#### Enable timing to capture

To enable capture interval, follow the steps below:

##### 1 Select **Enable Motion detection**

**2 Capture interval:** The interval time between two captures.

##### 3 Select the capture time

- Capture anytime

Click the black button up the MON, you will see all time range turn red. When something moving in the detection area at anytime, the camera will capture.

- Specify an capture schedule

Click the week day words, the corresponding column will be selected. For example, click TUE, the all column of TUE turns to red, that means during Tuesday whole day, the camera will capture.

- Press the left mouse and drag it on the time boxes, you can select the serial area,

**4 Click Save button** to take effect.

### 4.5.4 IR LED Schedule

On this page you can set the schedule time for switching IR LED lights. When parameter Mode is set to the **Schedule** on the **Live Video** window, at these schedule time, the IR LED lights will be turned off.



The screenshot shows a web interface titled "IR LED Schedule". At the top right, there are "Save" and "Refresh" buttons. Below the title, the text "IR LED Schedule" is displayed. A light blue box on the left contains the text "Set the close time". To the right of this box, there is a time selection area with the text "From" followed by two dropdown menus for hours and minutes, then "To" followed by another two dropdown menus for hours and minutes. Below the time selection area is an "Add" button.

## 4.6 Alarm

### Action Detection

IP Camera supports **Action Detection Alarm**, when the people has been detected, the IP Camera will make a alarm.

### Action Detection

Enable  **1**

Motion Detection	On <input type="button" value="v"/>	<b>2</b>
Human Detection	On <input type="button" value="v"/>	<b>3</b>
Sensitivity	Medium <input type="button" value="v"/>	<b>4</b>
Triggered Interval	10s <input type="button" value="v"/>	<b>5</b>
Action	<input type="checkbox"/> Camera Sound <input type="checkbox"/> PC Sound	<b>6</b>
	<input type="checkbox"/> Send E-mail	
	<input type="checkbox"/> Take Snapshot      Time Interval <input type="button" value="v"/> 2s	
	Please set the capture storage location in advance.	
	<input type="checkbox"/> Recording Please set the video storage location in advance.	
<input type="button" value="Set Detection Area"/> <b>7</b>		

**8**

All	00	01	02	03	04	05	06	07	08	09	10	11	12	13	14	15	16	17	18	19	20	21	22	23
MON																								
TUE																								
WED																								
THU																								
FRI																								
SAT																								
SUN																								

Scheduled recording will stop while alarm recording begins , and go on automatically after it ends.

**Step 1:** Enable Action detection function.

**Step 2:** Select the “on” from the dropdown box to activate the motion detection alarm.

**Step 3:** Select the “on” from the dropdown box to activate the human detection alarm.

**Step 4: Sensitivity**---- It supports five modes: Lowest, Lower, Low, Medium and High. The higher the sensitivity, the camera will be more easily alarmed. Select one motion sensitivity.

**Step 5: Trigger interval**--- The interval time between two motion detection.

**Step 6:** There are some alarm indicators:

**A Camera Sound and PC Sound**

If the camera has connected with a speaker or other audio output device, if you select Camera Sound or PC Sound, when the motion has been detected, the people around the camera will hear beep alarm sound.

**B Send E-mail**

If you want to receive alarm emails when motion is detected, you must select Send E-mail and set Mail Settings first.

**C Take Snapshot**

If you select this checkbox, when the motion has been detected, the camera will snap the live view window as a still picture and load it to the FTP. Make sure you have set FTP and set FTP as the storage path in Video->Snapshot settings panel.

**Time interval:** The interval time between two pictures.

**D Recording**

If you select this checkbox, when the motion has been detected, the camera will record automatically and store the record files to the SD Card. Make sure the camera has inserted SD card and you have set the SD card as the Alarm record files storage path, please go to **Record—> Storage location** page to verify this settings.

The default alarm record time is 30s and pre-alarm record time is 5s, please go to **Record—> Alarm Record** page and change the alarm time settings.

**Step 7: Set detection area**

Click set detect area and it pop up a window, then you can draw the detection area. Click **Back** button after settings. When something moving in the detection area, the camera will alarm.

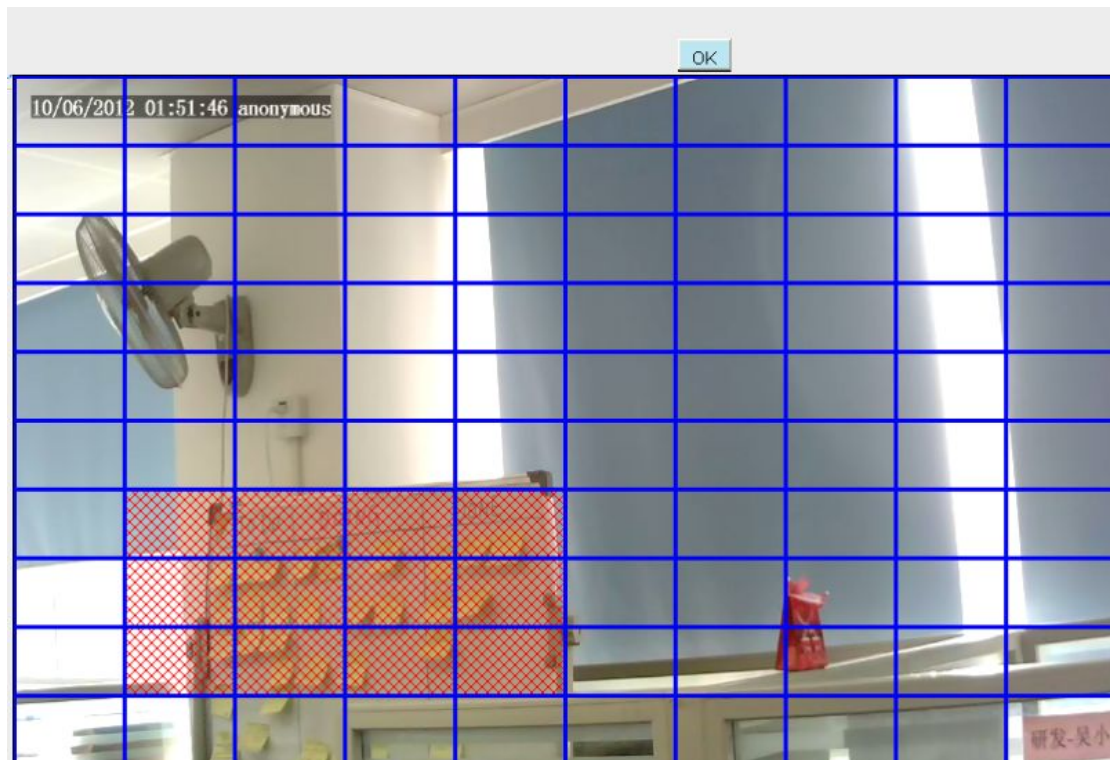

### Step 8: Alarm Schedule

① Alarm anytime when motion is detected

Click the black button up the MON, you will see all time range turn red. When something moving in the detection area at anytime, the camera will alarm.

	00	01	02	03	04	05	06	07	08	09	10	11	12	13	14	15	16	17	18	19	20	21	22	23
All																								
MON																								
TUE																								
WED																								
THU																								
FRI																								
SAT																								
SUN																								

② Specify an alarm schedule

Click the week day words, the corresponding column will be selected. For example, click TUE, the all column of TUE turns to red, that means during Tuesday whole day, when something moving in the detection area, the camera will alarm.





### Storage Location

Recording Location	FTP	
Local Recording Location	c:\IPCamRecord	<input type="button" value="Browse"/>

Recording Location is used for alarm recordings and schedule recordings.

The local recording must be stored in local storage. The default Windows storage location is "c:\IPCamRecord". The default Mac OS storage location is "/IPCamRecord". If you modify the path on other cameras, this default storage location will be modified accordingly.

**Recording Location** : SD card or FTP. **Make sure the camera has been inserted the SD card.** On this page, you can see the available space of the SD card.

**Local Recording Location:** For Windows OS, the manual recording path is C:/ IPCamRecord, you can change another one. For MAC OS, the manual recording path is: / IPCamRecord.

#### 4.7.2 Alarm Recording

### Alarm Recording

Enable Pre-Record

Pre-recorded Time	2s	
Alarm Recording Time	30s	

#### 4.7.3 Local Alarm Recording

This page you can enable the local alarm record and Local Alarm record time.

### Local Alarm Recording

Enable Local Alarm Recording

Local Alarm Recording Time	30s	
----------------------------	-----	--

#### 4.7.4 Schedule Recording

**When the video is selected as FTP, the device supports scheduled recording.**

When the parameter **Recording Location** is set **SD Card** on the **Storage Location** page, you can configure parameters as shown in follow figure.



### Storage Location

Recording Location	FTP
Local Recording Location	c:\IPCamRecord <input type="button" value="Browse"/>

### Scheduled Recording

Enable Scheduled Recording

Stream:

All	00	01	02	03	04	05	06	07	08	09	10	11	12	13	14	15	16	17	18	19	20	21	22	23
MON																								
TUE																								
WED																								
THU																								
FRI																								
SAT																								
SUN																								

Scheduled recording only supports SD card or FTP server.  
 Scheduled recording will stop while alarm recording begins, and go on automatically after it ends.

**When the video is selected as SD card, the device supports pumping frame recording.**

When the parameter **Recording Location** is set **SD Card** on the **Storage Location** page, you can configure parameters as shown in follow figure.

### Storage Location

Recording Location	SD card 372.2 MB / 7.4 GB
Local Recording Location	c:\IPCamRecord <input type="button" value="Browse"/>

### Scheduled Recording

Enable Scheduled Recording

Enable Long-time recording

Frame Rate

Record full strategy

Audio Record

Stream

 Edit Scheduled Recording

All	00	01	02	03	04	05	06	07	08	09	10	11	12	13	14	15	16	17	18	19	20	21	22	23
MON																								
TUE																								
WED																								
THU																								
FRI																								
SAT																								

**Frame Rate:** There are six frame selections, such as 1/30, 4/30, 8/30, 15/30, 24/30, 30/30.

Recommended default is 4/30. The greater the Frame rate is, the sharper picture quality is, and the greater of storage space is, the shorter the storage time is.

**Record full strategy:** When the SD card is full, you can choose to cover the previous recording, or stop recording.

**Audio Record:** You can choose "yes" or "no".

#### NOTES:

- Scheduled recording only supports video saved to the SD card or FTP server.
- The schedule recording will stop while alarm recording is beginning, and it will continue automatically after alarm recording end.
- You can refer to "alarm schedule." in "Alarm" about editing the time of recording Schedule.

### 4.7.5 SD Card Management

This camera supports SD Card and the max size of SD card must be under 32G.

When you plug in the SD card during the camera work process, please reboot the camera again, or else the SD Card may be cannot work well.

## SD Card Management

Refresh	
SD Card Status	No SD card
SD Card Free Space	0KB
SD Card Total Space	0KB

Note: SD card management is only effective when access the IPC in LAN

The default storage path of alarm record files is SD card, when the available size of SD card is less than 256M, the old record files will be deleted automatically.

## 4.8 Firewall

This section explains how to control the access permission by checking the client PC's IP addresses. It is composed of the following columns: **Block access from these IP addresses** and **Only allow access from these IP addresses**.

Save Refresh	
Enable Firewall <input checked="" type="checkbox"/>	
IP Filtering	Block access from these IP addresses Block access from these IP addresses Only allow access from these IP addresses
IP Address #1	<input type="text"/>
IP Address #2	<input type="text"/>
IP Address #3	<input type="text"/>
IP Address #4	<input type="text"/>
IP Address #5	<input type="text"/>
IP Address #6	<input type="text"/>
IP Address #7	<input type="text"/>
IP Address #8	<input type="text"/>

Enable firewall, If you select Only allow access from these IP addresses and fill in 8 IP addresses at most, only those clients whose IP addresses listed in the **Only allow access from these IP addresses** can access the Network Camera. If you select **Block access from these IP addresses**, only those clients whose IP addresses are in the IP list cannot access the Network Camera.

Click **Save** to take effect.

## 4.9 System

In this panel, you can backup/restore your camera settings, upgrade the firmware to the latest version, restore the camera to default settings and reboot the device.

## 4.9.1 Back-up& Restore

Click **Backup** to save all the parameters you have set. These parameters will be stored in a bin file for future use.

Click Browse and select the parameters file you have stored, then click Submit to restore the restore the parameters.

Backup is used to save your current settings. It is recommended to backup your configuration before modifying or upgrading firmware.

Settings can be restored by uploading the backup file.

Path:

Note:

1. All current settings will be lost when importing a configuration file. If an incorrect file is loaded, the camera may stop working correctly.
2. Keep the power on during this process, or you may damage your camera. Your camera will reboot automatically once restoration is completed.

## 4.9.2 System Upgrade

Click “Download the latest firmware”, you will see the following screen. And click “save” to save the firmware on your computer locally.

**System Upgrade**

Current Firmware Version: 2.52.1.29

Result

Your camera will reboot during the firmware upgrade.

Do you want to open or save C:\1.zip (6.88 MB) from www.foscam.com?    ×

Your current firmware version will be displayed on your screen. You may go to the **Status → Device Information** page to check for the latest firmware versions available.

Click **Browse**, choose the correct bin file and then click **System upgrade**.  
 Don't shut down the power during upgrade. After upgrading, you can see the upgrade result.



## Upgrade Firmware by IP Camera Tool



Double click the IP Camera Tool shot icon, select the Camera IP that you want to upgrade the firmware. Then select Upgrade Firmware and enter the username and password, choose the firmware file, and upgrade.

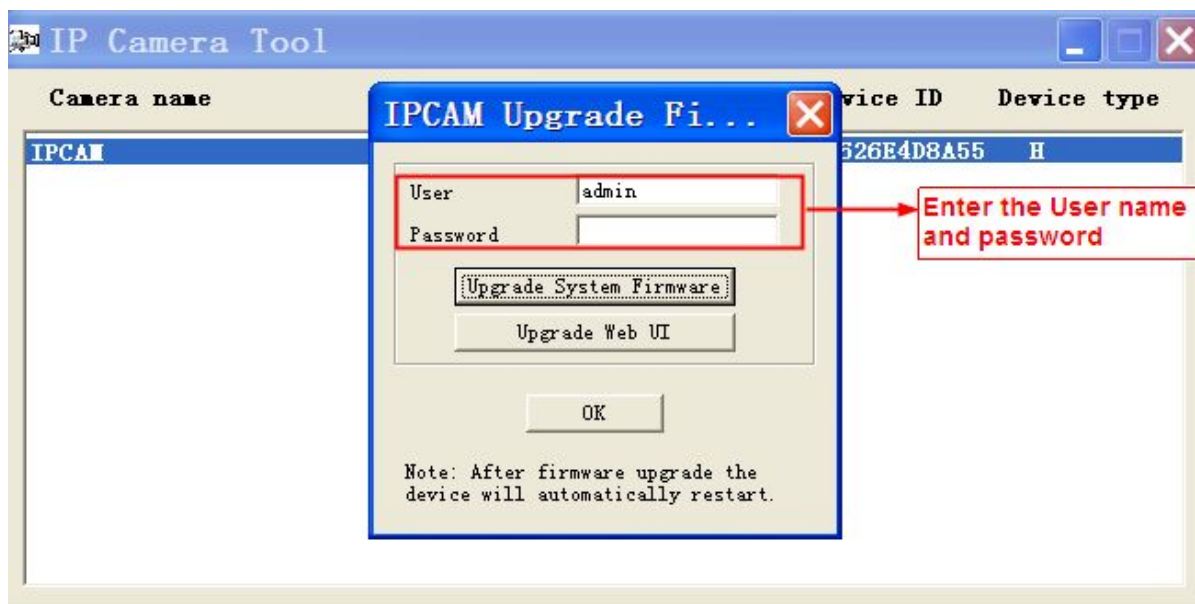
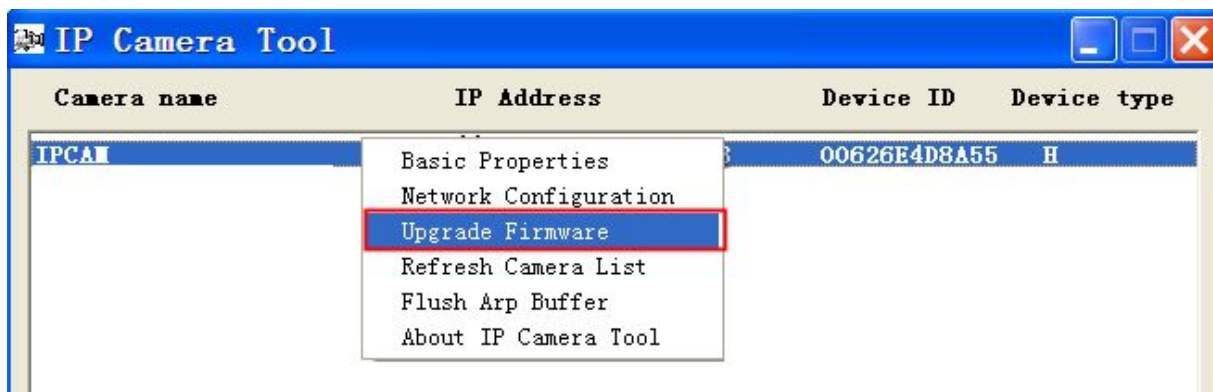



**CAUTION:** If your camera works well with the current firmware, we recommend not upgrading. Please don't upgrade the firmware unnecessarily. Your camera may be damaged if misconfigured during an upgrade.

#### NOTES:

- Please ensure you have download the correct firmware package for your camera before upgrading. Read the upgrade documentation (readme.txt file) in the upgrade package before you upgrade.
- Upon downloading the firmware check the sizes of the .bin files. They must match the size in the readme.txt file. If not, please download the firmware again until the sizes are the same. Your camera will not function correctly if a corrupt .bin file is used.
- Normally, only Device WEB UI need to be upgrade, please do not try to upgrade the Device System Firmware.
- Never shut down the power of the camera during upgrade until the IP camera restart and get connected.
- After upgrade successfully, please uninstall the old plugin and re-install it, then reset the camera to the default factory settings before using the camera.

### 4.9.3 Patch Installation

Click "Browse" to select the correct patch file, and then click "Install Patch" to install the patch. Do not turn off the power during it installing. After installing is complete, you will receive a system prompt.

The screenshot shows a web interface titled "Patch Installation". It features a file selection area with a "Browse..." button and an "Install Patch" button. Below this is an "Uninstall Patch" button and a "Result" field. A note at the bottom states: "Your camera will reboot when you install/uninstall patch."

### 4.9.4 Factory Reset

Click All reset and all parameters will return to factory settings if selected. This is similar to press the Reset button on the bottom of the camera.

The screenshot shows a web interface titled "Factory Reset". It contains a "Factory Reset" button and a text instruction: "Click this button to reset the camera to factory default."

### 4.9.5 Reboot

Click Reboot System to reboot the camera. This is similar to unplugging the power to the camera.

The screenshot shows a web interface titled "Reboot". It contains a "Reboot" button and a text instruction: "Click this button to reboot your camera."



## 5 Playback

On this page you can view the record files stored in the SD card.

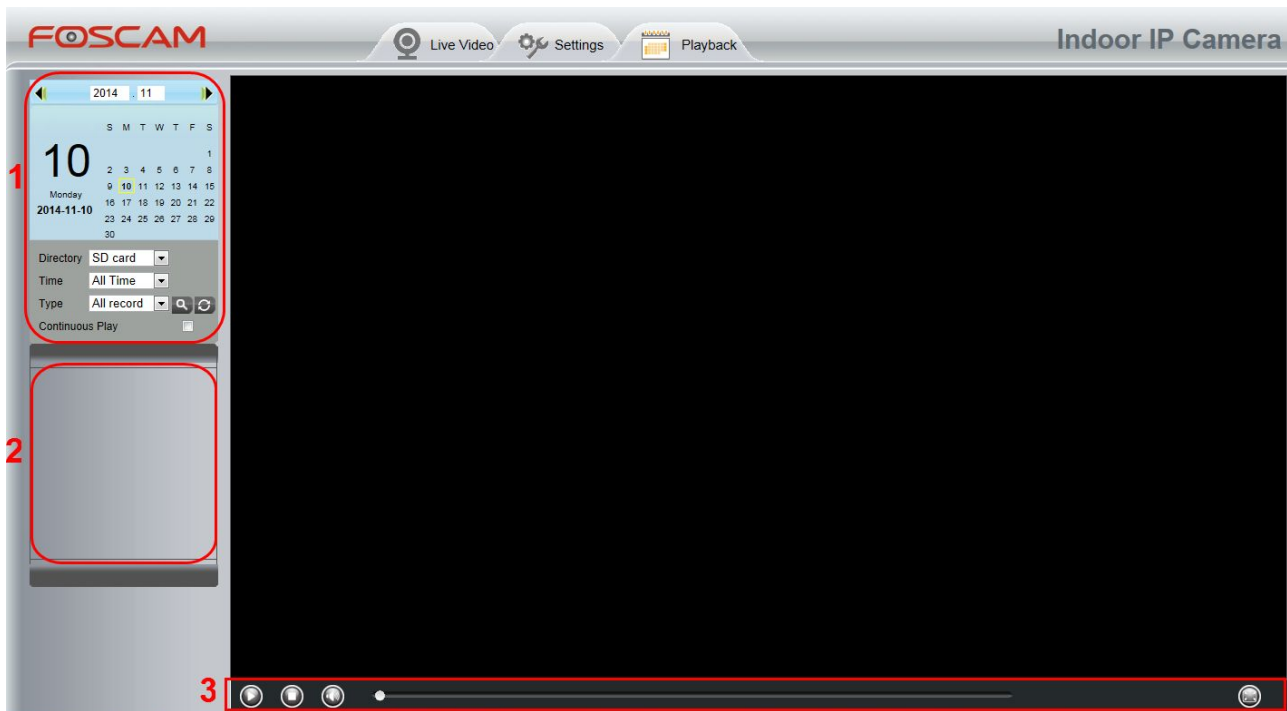

### Section 1 Define the Record files time and Type

Directory  : The storage path of record files

Time  : Here supports three types: current day, current month and All records. Another way, select the time on the time&date manually.



Type  : The type of records files, Here supports two types: Normal record, Alarm record and All records.



: Click this button to search all record files satisfy the conditions you selected.

Continuous Play: Select the checkbox to play continuously all the record files.

## **Section 2 Search record files**

On this panel you can see all record files satisfy the conditions you set.

## **Section 3 Play/Stop/Audio/Full screen buttons**

Please select one record file before use these buttons.



Click this button to play the record files



Click this button to stop the record files



Open or stop audio



Click this button to make full screen, and double click left mouse to exit full screen.

# 6 Appendix

## 6.1 Frequently Asked Questions

### 6.1.1 Install the add-on of Firefox browser, Google Chrome and IE Chrome.

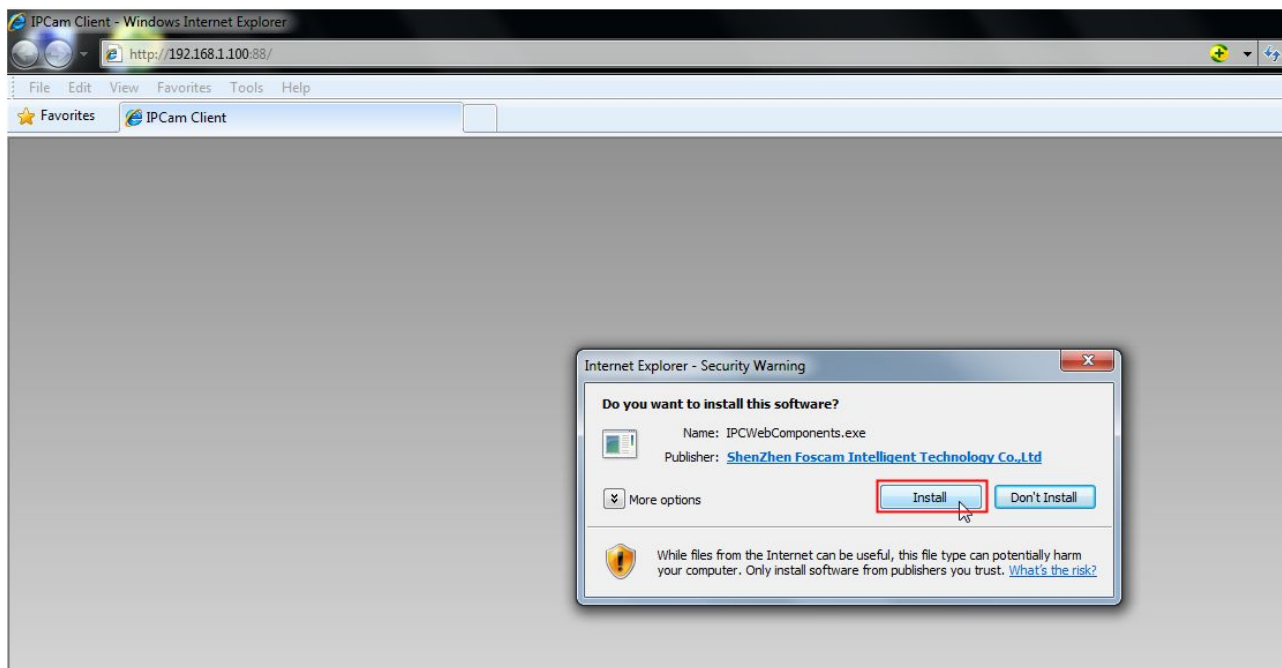

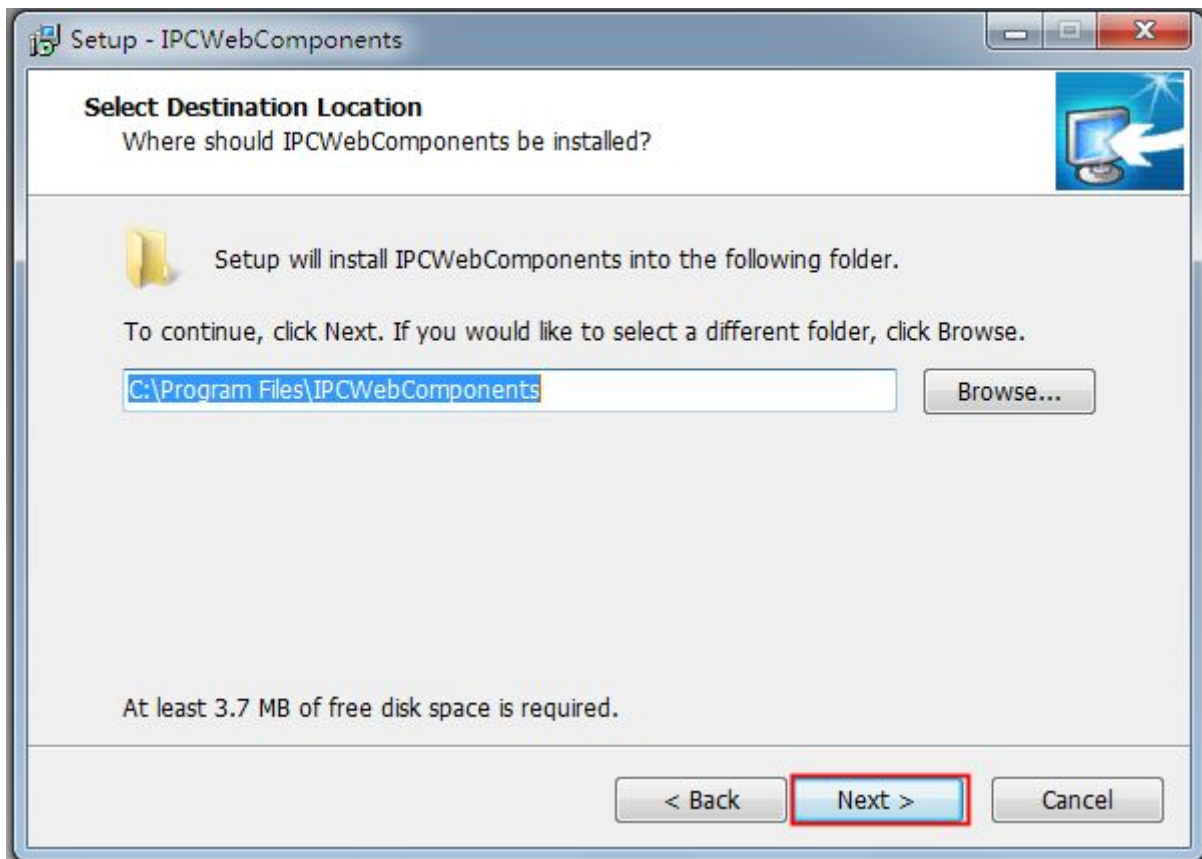
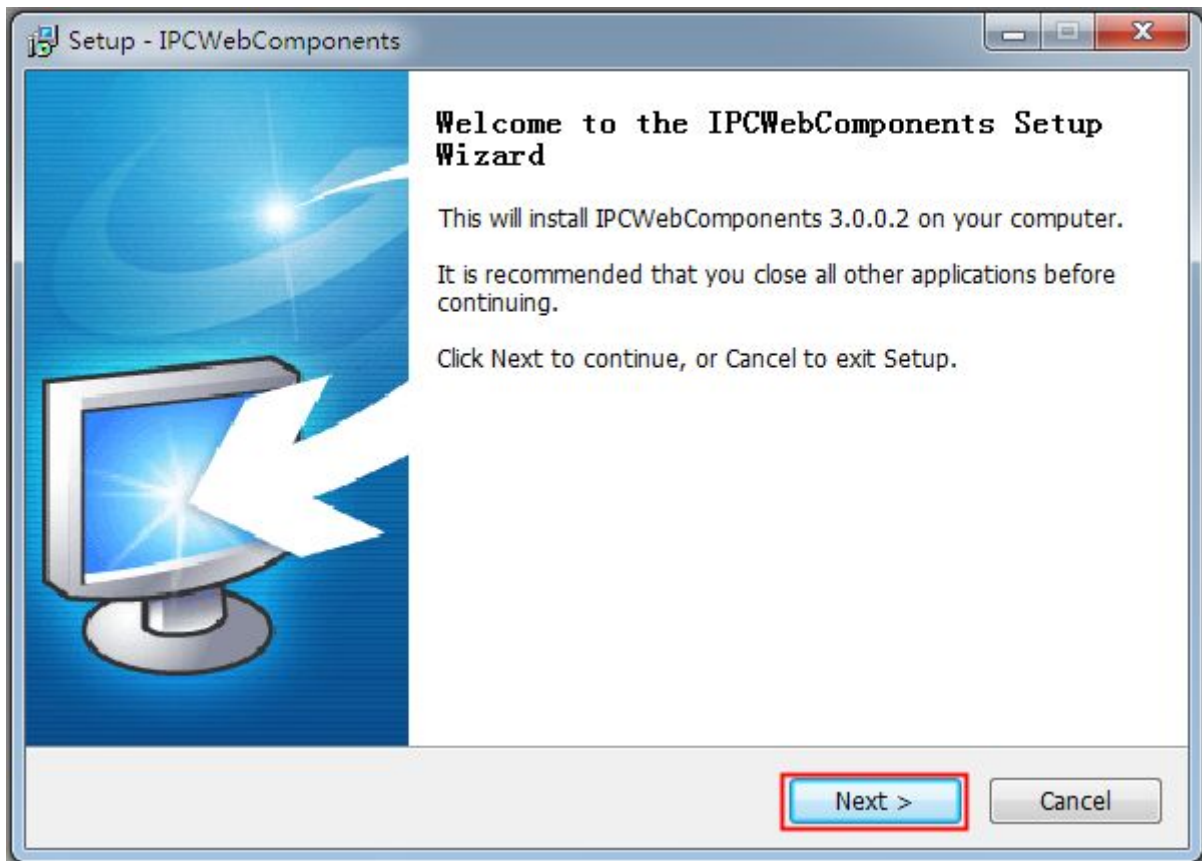

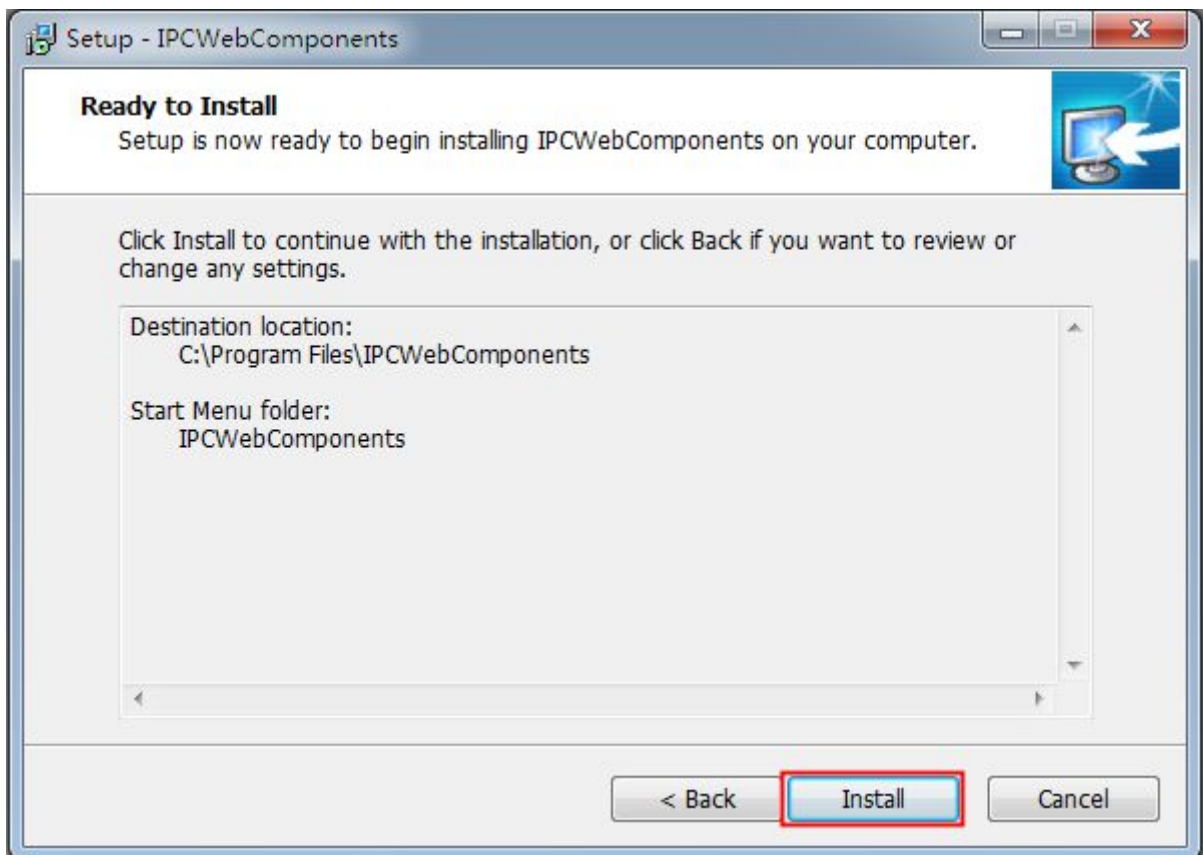
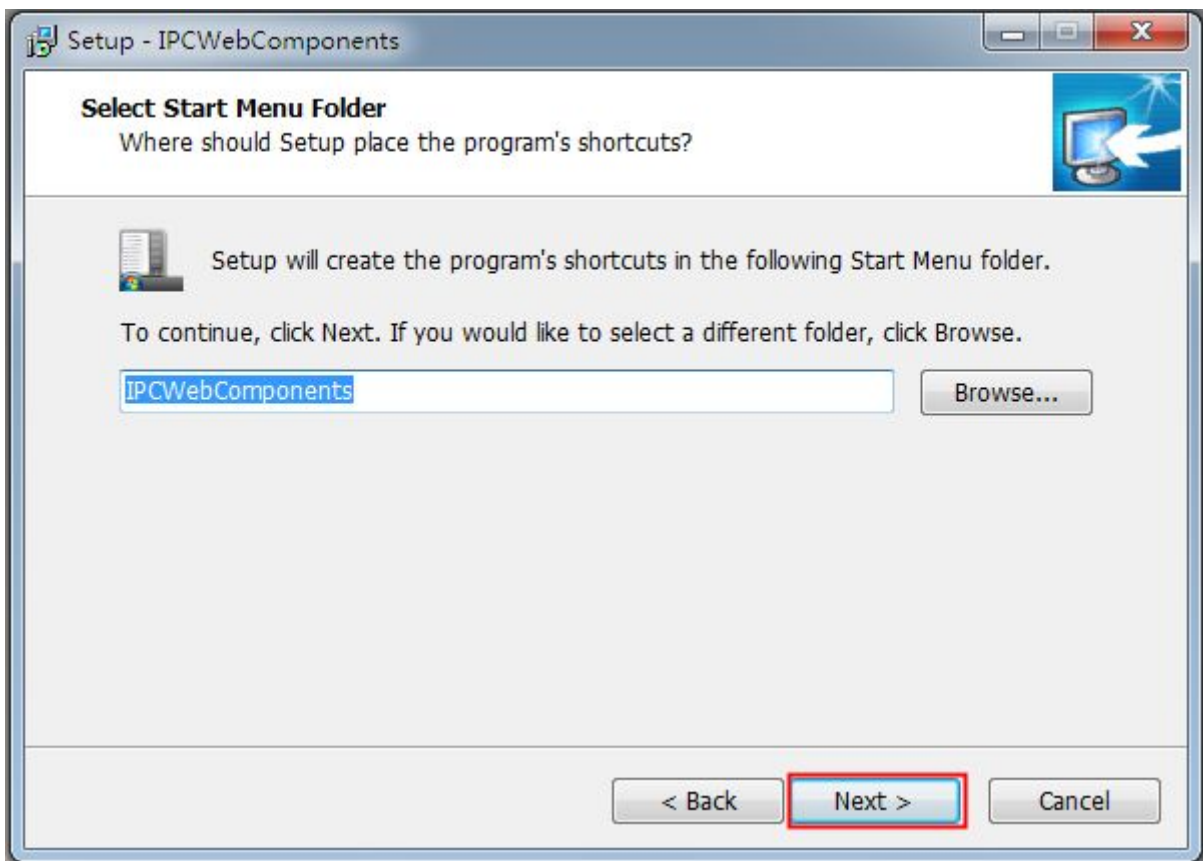

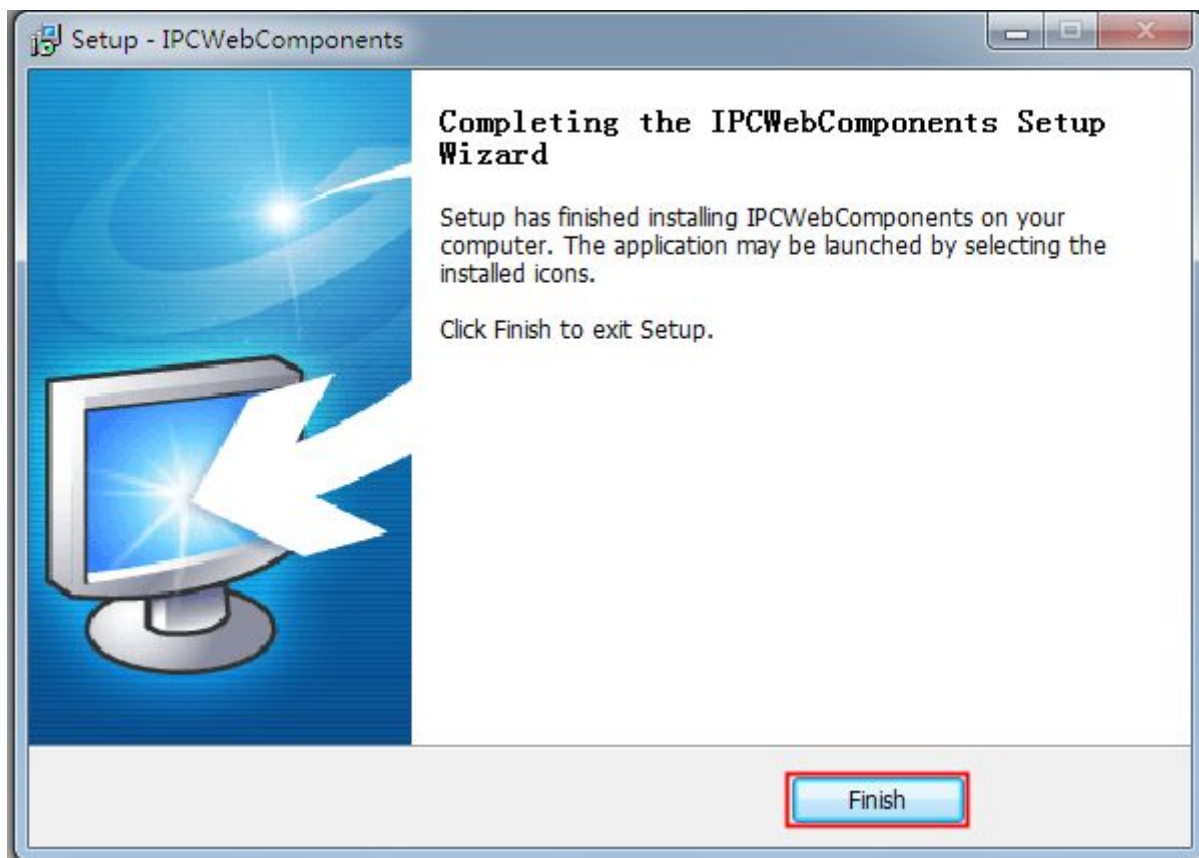



### 6.1.2 Uninstall the add-on of Firefox browser, Google Chrome and IE Chrome.

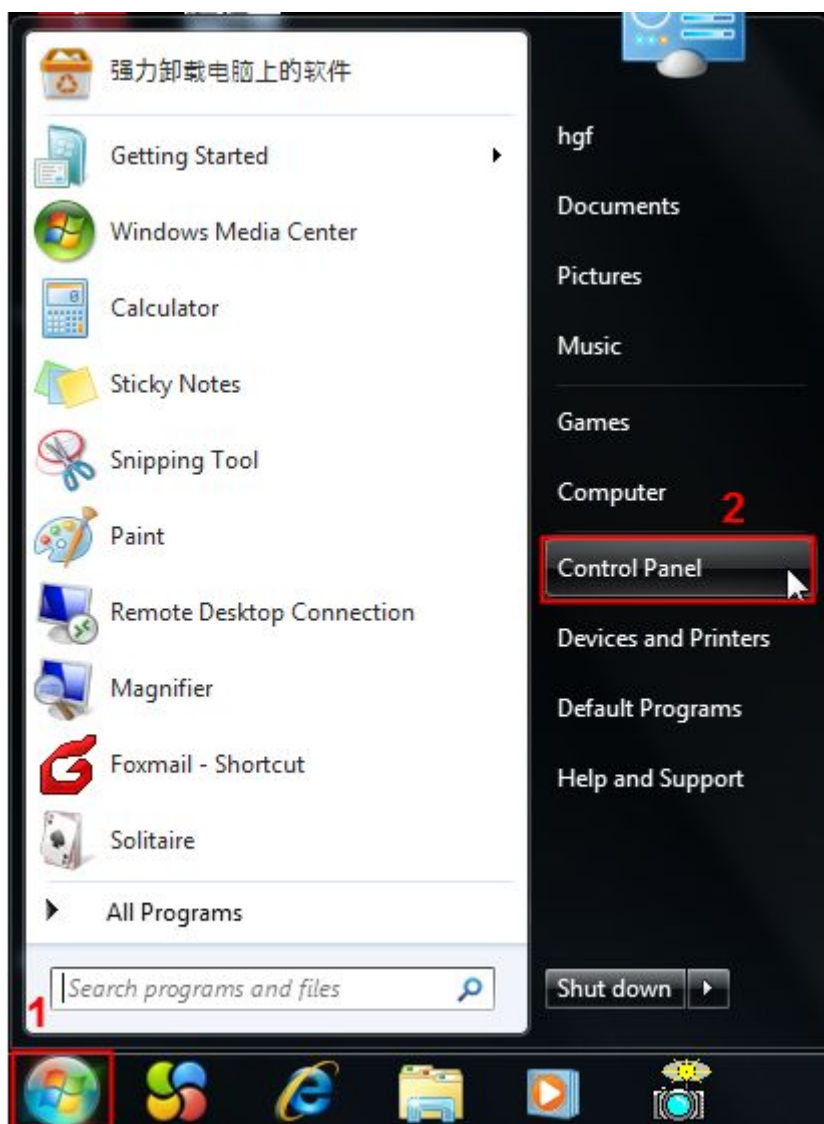

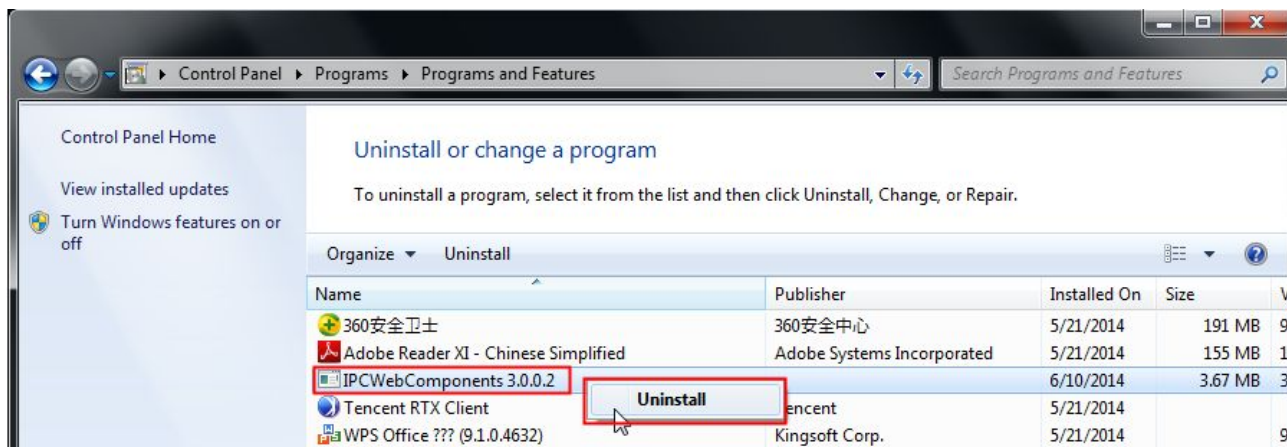
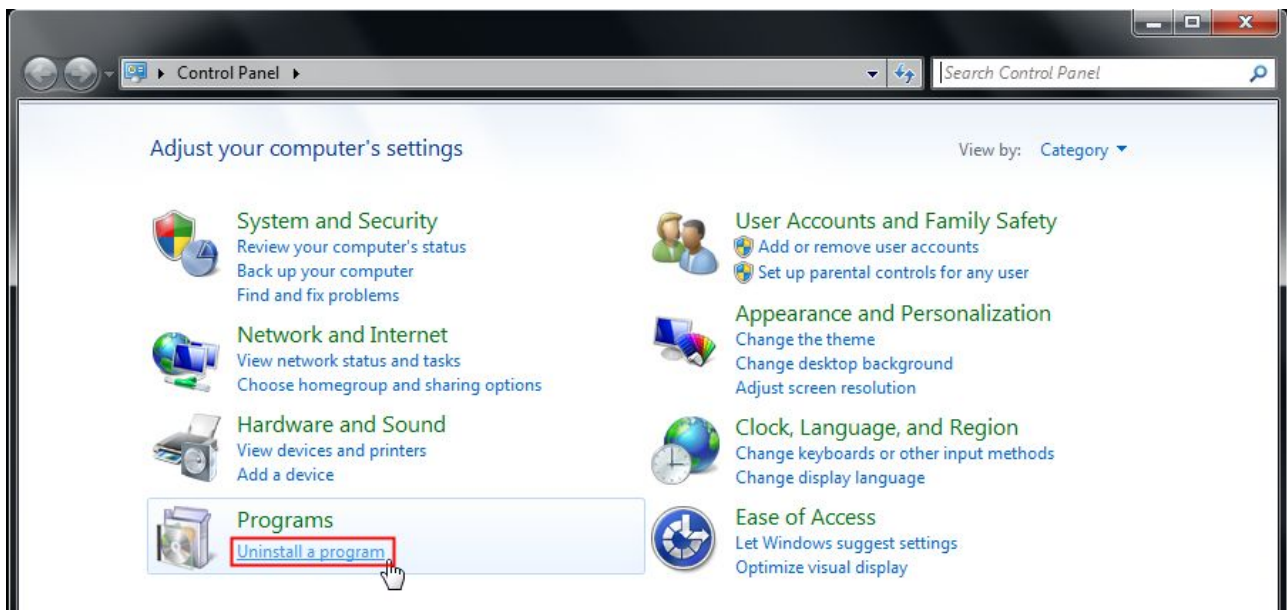

### 6.1.3 I have forgotten the administrator password

To reset the administrator username and password, press and hold down the RESET BUTTON for 5 seconds. Upon releasing the reset button, wait for 20 seconds, the camera will reboot and the username and password will return to the factory default administrator username and password. Please power on the camera before reset

**Default administrator username: admin**

**Default administrator password: No password**

### 6.1.4 Camera can not record

When you use Windows7 or Vista, you may be not able to do manually record or change the record path because of the security settings of computer.

There are two ways to resolve this problem:

Please add the camera as a trusted site to resolve this issue. The steps are :

IE browser→Tool→Internet Properties→Security→Trusted sites→Sites→Add

Open IE browser, then right click, select "Run as administrator"

### 6.1.5 Subnet doesn't match

Check whether your ipcamera in the same subnet of your computer. The step is **Control Panel**→**Network Connections**→**Dbclick Local Area Connections** → Choose **General**→**Properties**. Check subnet mask, IP address and gateways. When you set IP address please make sure they are in the same subnet. Otherwise you can't access camera.

### 6.1.6 No Pictures Problems

The video streaming is transmitted by the ActiveX controller. If ActiveX controller isn't installed correctly you will see no video image. You can resolve this problem by this way:

Download ActiveX controller and set the safety property of IE in the PC when you view it first time: IE browser→Tool→Internet Proper→Security→Custom Level→ActiveX control and Plug-ins. Three options of front should be set to be "Enable", The ActiveX programs read by the computer will be stored. As follows:

**Enable: Download unsigned ActiveX controls**

**Enable: Initialize and script ActiveX controls not marked as safe**

**Enable: Run ActiveX controls and plug-ins**

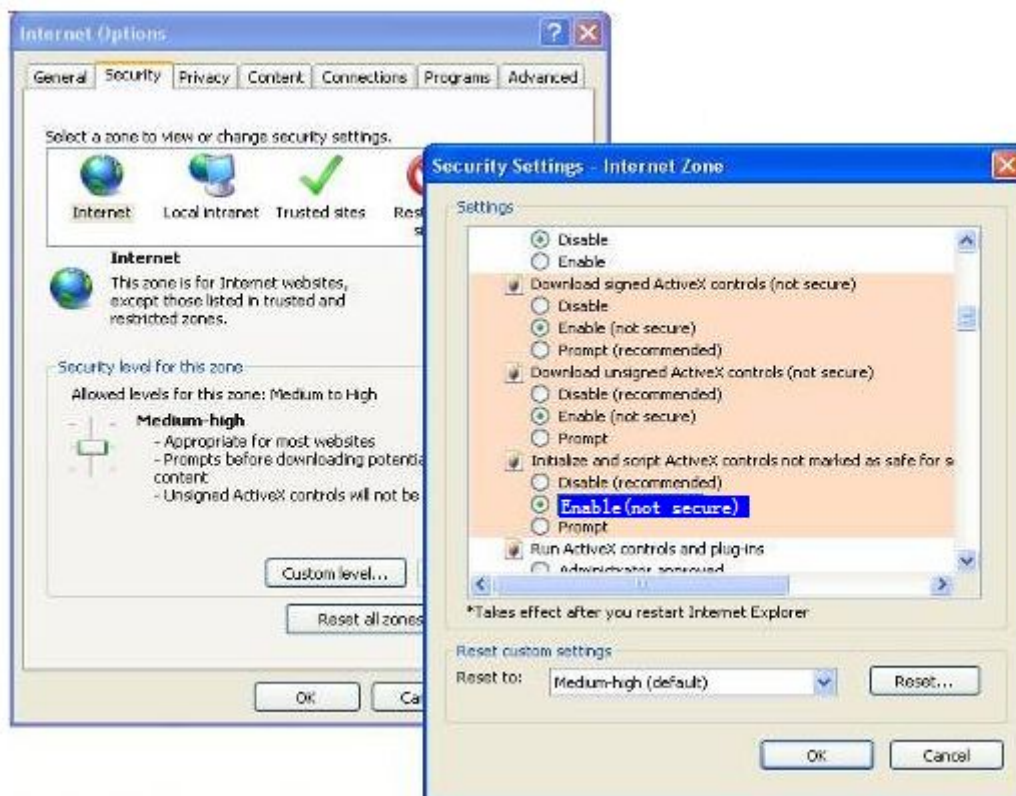

If you allow the ActiveX running, but still could not see living video. Please change another port number to try. Don't use port 88.

Port	
HTTP Port	88
HTTPS Port	443
ONVIF Port	888
RTSP port	554

**NOTE:** Make sure that your firewall or anti-virus software does not block the camera or ActiveX. If you could not see video, please shut down firewall or anti-virus software to try again.

### 6.1.7 Can't access IP camera in internet

There are some reasons:

- 1、ActiveX controller is not installed correctly
- 2、The port which camera used is blocked by Firewall or Anti-virus software. Please change another port number and try again.
- 3、Port forwarding is not successful

Check these settings and make sure they are correct.

### 6.1.8 UPnP always failed

UPnP only contains port forwarding in our recent software. Sometimes, it may be failed to do port forwarding automatically because of firewall or anti-virus software. It also has much relation with router's security settings. So we recommend you do port forwarding manually. You can view your camera in internet successfully after you do port forwarding manually in your router.

### 6.1.9 Camera can not connect wireless

If your camera could not connect wireless after you set wireless settings and plug out the cable. Please check whether your settings are correct or not.

Normally, camera can't connect wireless mainly because of wrong settings.

Make sure broadcast your SSID; use the same encryption for router and camera.

### 6.1.10 Can't see other cameras listed in multi-device when using remote access

If you want to view all the cameras via the WAN, verify that each camera added in the multi-device settings can be accessed by using the DDNS name and port number. Use the DDNS domain name not the camera's LAN IP. (For more details see: How to add cameras in WAN)

## 6.2 Default Parameters

### Default network Parameters

IP address: obtain dynamically

Subnet mask: obtain dynamically

Gateway: obtain dynamically

DDNS: Embedded FOSCAM domain name

### Username and password

Default admin username: admin with a blank password

## 6.3 Specifications

ITEMS		C1
<b>Image Sensor</b>	Sensor	High Definition Color CMOS Sensor
	Display Resolution	1280 x 720 (1Megapixels)
	Min. Illumination	0 Lux (With IR Illuminator)
<b>Lens</b>	Lens Type	Glass Lens
	focal length	f:2.8mm
	Aperture	F2.4
	Diagonal angle of view	115°
	Horizontal view angle	100°
<b>Video</b>	Image Compression	H.264
	Image Frame Rate	25fps (VGA) , 23fps (720P) , downward adjustable
	Resolution	720P(1280 x 720), VGA(640 x 480), VGA(640 x 360), QVGA(320 x 240), QVGA(320 x 180)
	Stream	dual stream
	Image adjustment	The hue, brightness, contrast, saturation, sharpness are adjustable
	Flip image	flip and mirror
	Infrared mode	Automatic or manual
	manual Pan/Tilt Angle	Horizontal:350° & Vertical: 180°
Night visibility	11pcs IR-LEDs, night vision range up to 8 metres	
<b>Audio</b>	Input/Output	Supports two-way audio Built-in Mic & Speaker
	Audio Compression	PCM/G.726
<b>Network</b>	Ethernet	One 10/100Mbps RJ45 port
	Wireless Standard	IEEE802.11b/g/n
	Data Rate	IEEE802.11b: 11Mbps(Max.); IEEE802.11g: 54Mbps(Max.); IEEE802.11n: 150Mbps(Max.).
	Wireless Security	WEP, WPA, WPA2
	WPS	Supports EZLink wireless setup

	Network Protocol	IP、TCP、UDP、HTTP、HTTPS、SMTP、FTP、DHCP、DDNS、UPnP、RTSP、WPS
	Remote Access	P2P, DDNS
<b>System Requirements</b>	Operating System	Microsoft Windows XP, Vista, 7, 8; Mac OS iOS、Android
	Browser	Microsoft IE8 and above version or compatible browser; Mozilla Firefox; Google Chrome; Apple Safari.
<b>Other Features</b>	Motion Detection	Alarm via E-Mail, upload alarm snapshot to FTP
	PIR	Infrared human body sensor
	User Accounts	Three levels user role
	Firewall	Supports IP Filtering
	Storage	32G Micro SD card, local and FTP storage
	Reset	Reset button is available
<b>Power</b>	Power Supply	DC 5V/1.0A
	Power Consumption	4.5W (Max)
<b>Physical</b>	Dimension(LxWxH)	70*70*120mm
	Net Weight	170g
<b>Environment</b>	Operating Temperature	-10°C ~ 50° (14°F ~ 122°F)
	Operating Humidity	20% ~ 85% non-condensing
	Storage Temperature	-20°C ~ 60° (-4°F ~ 140°F)
	Storage Humidity	0% ~ 90% non-condensing
<b>Certification</b>	CE, FCC, RoHS	
<b>Warranty</b>	Limited 1-year warranty	

**Attention: Power adapter should be used between 0°C-40°C, and 5%-90% relative humidity.**

## 6.4 CE & FCC

### Electromagnetic Compatibility (EMC)

#### FCC Statement



**This device complies with FCC Rules Part 15. Operation is subject to the following two conditions.**

- This device may not cause harmful interference



- This device must accept any interference received, including interference that may cause undesired operation.

This equipment has been tested and found to comply with the limits for a Class B digital device, pursuant to Part 15 of the FCC Rules. These limits are designed to provide reasonable protection against harmful interference when the equipment is operated in a commercial environment. This equipment generates, uses, and can radiate radio frequency energy and, if not installed and used in accordance with the installation manual, may cause harmful interference to radio communications. Operation of this equipment in a residential area is like to cause harmful interference, in which case the user will be required to correct the interference at his own expense.

### FCC Caution

Any changes or modification not expressly approved by the party responsible for compliance could void the user's authority to operate this equipment.

This equipment complies with FCC radiation exposure limits set forth for an uncontrolled environment. This equipment should be installed and operated with minimum distance 20cm between the radiator & your body.

This transmitter must not be co-located or operating in conjunction with any other antenna or transmitter.

### CE Mark Warning



This is a Class B product. In a domestic environment, this product may cause radio interference, in which case the user may be required to take adequate measures.

## 7 Obtaining Technical Support

While we hope your experience with the IPCAM network camera is enjoyable and easy to use, you may experience some issues or have questions that this User's Guide has not answered. Please contact support via e-mail at [support@foscam.us](mailto:support@foscam.us). You can also reach technical support at **1-800-930-0949** by following the automated instructions.

