

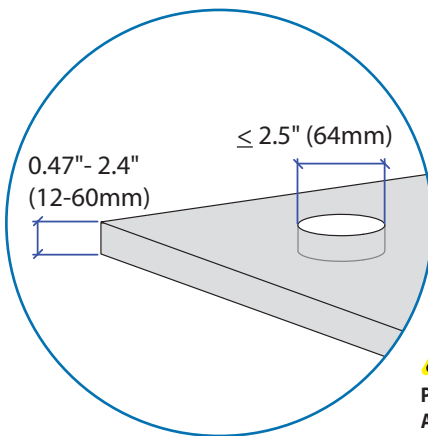

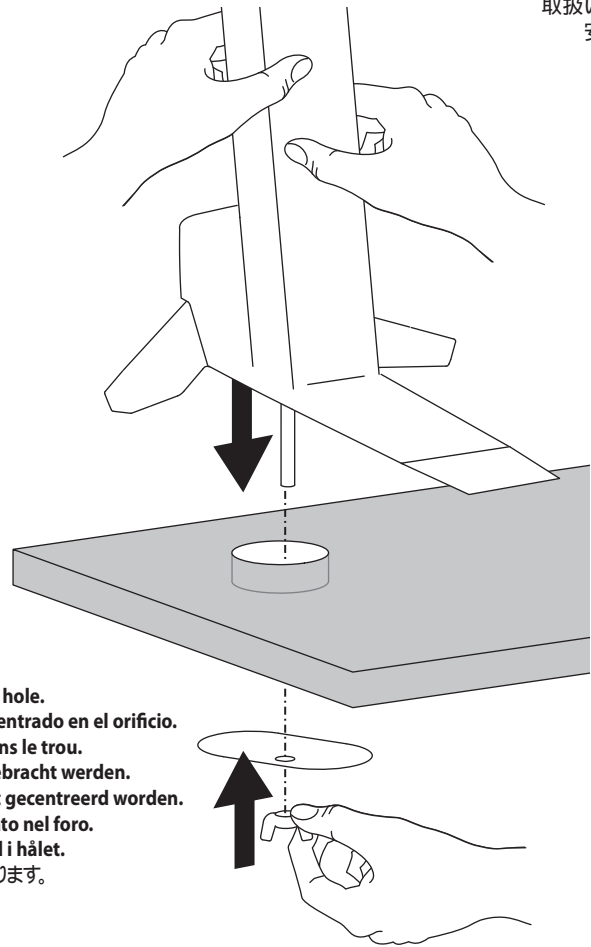



For service and warranty visit www.ergotron.com
 Si desea información de servicio y garantía, visite www.ergotron.com
 Pour toute question concernant la garantie ou le service client, consultez www.ergotron.com
 Weitere Informationen zu Service und Gewährleistung erhalten Sie unter www.ergotron.com.
 Ga voor service en garantie naar www.ergotron.com
 Per assistenza e la garanzia visitate www.ergotron.com
 Gå in på www.ergotron.com för service och garanti
 サービスおよび保証について詳しくは、www.ergotron.com をご覧ください。
 有关服务和保修，请访问 www.ergotron.com

 www.ergotron.com
 USA 1-800-888-8458
 Europe +31 (0)33-45 45 600
 China 86-769-86018920

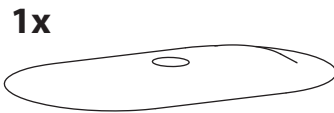

 **CAUTION:** Bolt must be centered in hole.
PRECAUCIÓN: El pasador tiene que estar centrado en el orificio.
ATTENTION: Le boulon doit être centré dans le trou.
VORSICHT: Die Schraube muss mittig angebracht werden.
WAARSCHUWING: De bout moet in het gat gecentreerd worden.
ATTENZIONE: il bullone deve essere centrato nel foro.
VAR AKTSAM: Bulten måste vara centrerad i hålet.
 注意：ボルトは穴の中央に位置する必要があります。
 小心：螺栓必须在孔内居中。

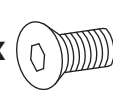
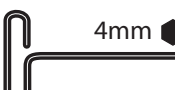
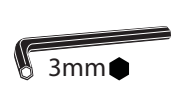

	A	B	C	D	E
1	1x 	1x 	1x 	1x 	4x 
2	4x  M5 x 10mm	1x  4mm	1x  3mm		

 **Warning:** Because mounting surface materials can vary widely, it is imperative that you make sure mounting surface is strong enough to handle mounted product and equipment.

Advertencia: Dado que los materiales de la superficie de montaje pueden variar enormemente, es imprescindible que se cerciore de que la superficie sea lo suficientemente resistente como para sostener el equipo y el producto montados.

Avertissement : Dans la mesure où les matériaux des surfaces de montage varient, vous devez impérativement vous assurer que la surface est suffisamment solide pour supporter le produit et l'équipement monté.

Warnung: Weil die Materialien der Befestigungsflächen stark variieren können, müssen Sie unbedingt gewährleisten, dass die Befestigungsfläche stark genug ist, um das montierte Produkt und die Ausrüstung zu tragen.

Waarschuwing: Omdat materiaal voor de oppervlakken van bevestigingsstukken nogal verschillend kan zijn, is het van het grootste belang dat u ervoor zorgt dat het oppervlak van het bevestigingsstuk sterk genoeg is om daarop gezette producten en apparatuur te behandelen.

Avvertenza: poiché i materiali delle superfici di montaggio possono variare enormemente, è essenziale accertarsi che la superficie di montaggio sia abbastanza forte da poter sostenere il prodotto e l'apparecchiatura montati.

Varning: Eftersom monteringsytans material kan variera väldigt mycket, så är det nödvändigt att du ser till att monteringsytan är tillräckligt stark för att kunna hantera monterade produkter och utrustning.

警告：取り付け表面の材質にはさまざまな種類があるため、取り付け表面が取り付け製品や器具に対応した強さであることを必ず確認してください。

警告：由于安装表面材质差异很大，必须确保安装表面足以支撑所安装的产品和设备。

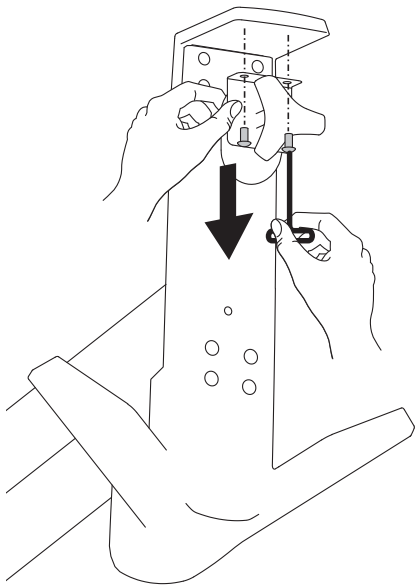

2

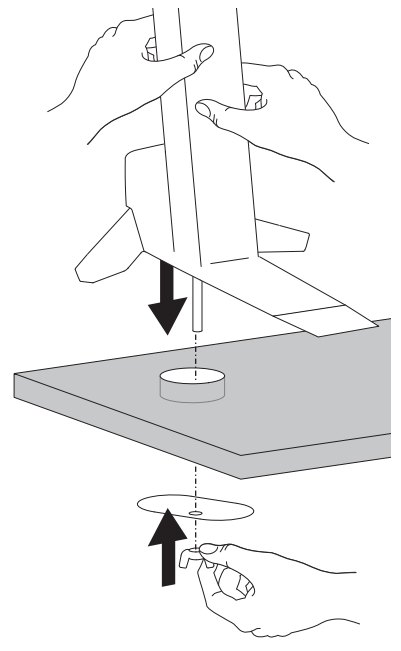
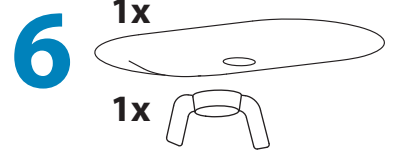
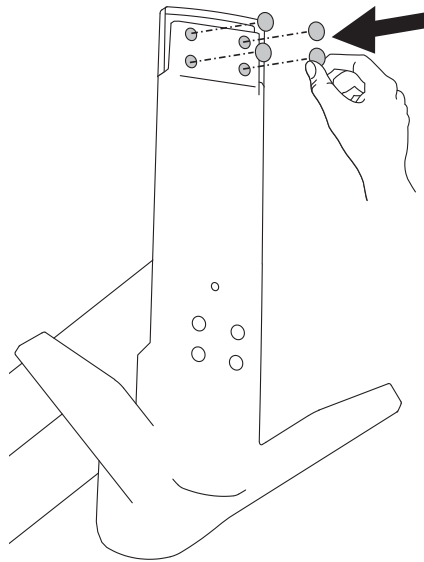
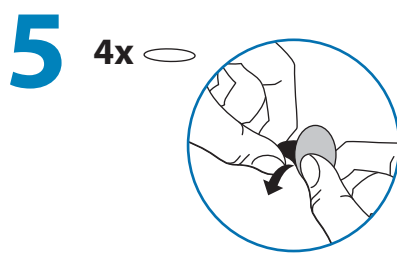
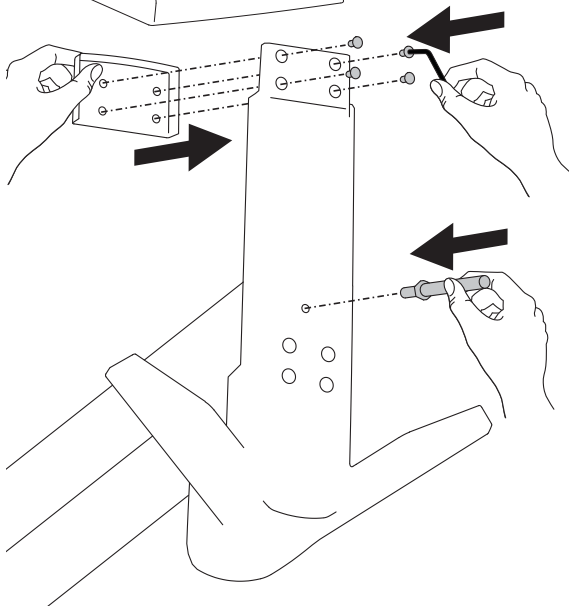
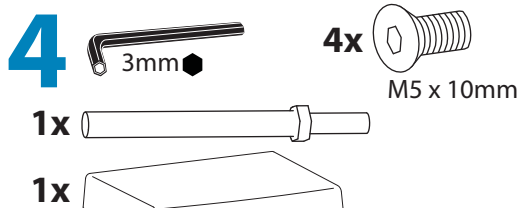
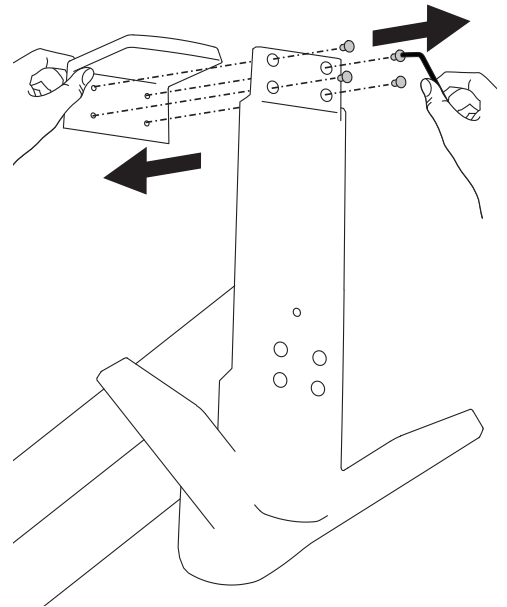
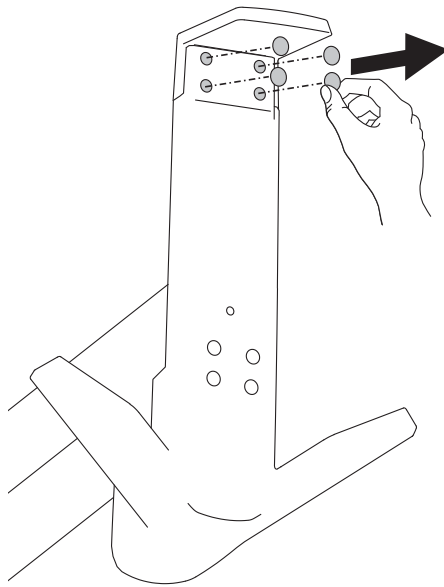

© 2012 Ergotron, Inc.
All rights reserved.

While Ergotron, Inc. makes every effort to provide accurate and complete information on the installation and use of its products, it will not be held liable for any editorial errors or omissions (including those made in the process of translation from English to another language), or for incidental, special or consequential damages of any nature resulting from furnishing this instruction and performance of equipment in connection with this instruction. Ergotron, Inc. reserves the right to make changes in the product design and/or product documentation without notification to its users. For the most current product information, or to know if this document is available in languages other than those herein, please contact Ergotron. No part of this publication may be reproduced, stored in a retrieval system, or transmitted in any form or by any means, electronic, mechanical, photocopying, recording or otherwise without the prior written consent of Ergotron, Inc., 1181 Trapp Road, Eagan, Minnesota, 55121, USA. Patents Pending and Patented U.S. & Foreign. Ergotron is a registered trademark of Ergotron, Inc.

Americas Sales and Corporate Headquarters

St. Paul, MN USA
(800) 888-8458
+1-651-681-7600
www.ergotron.com
sales@ergotron.com

EMEA Sales

Amersfoort, The Netherlands
+31 33 45 45 600
www.ergotron.com
info.eu@ergotron.com

APAC Sales

Tokyo, Japan
www.ergotron.com
apaccustomerservice@ergotron.com

Worldwide OEM Sales

www.ergotron.com
info.oem@ergotron.com