

A large, stylized gear graphic is positioned on the left side of the cover. It is composed of white outlines against the orange background. The gear has several teeth, and its center is partially obscured by a circular outline.

Tenda

User Guide

Copyright Statement

© 2015 Shenzhen Tenda Technology Co., Ltd. All rights reserved.

Tenda is a registered trademark legally held by Shenzhen Tenda Technology Co., Ltd. Other brand and product names mentioned herein are trademarks or registered trademarks of their respective holders. Copyright of the whole product as integration, including its accessories and software, belongs to Shenzhen Tenda Technology Co., Ltd. No part of this publication can be reproduced, transmitted, transcribed, stored in a retrieval system, or translated into any language in any form or by any means without the prior written permission of Shenzhen Tenda Technology Co., Ltd

Disclaimer

Pictures, images and product specifications herein are for references only. To improve internal design, operational function, and/or reliability, Tenda reserves the right to make changes to the products without obligation to notify any person or organization of such revisions or changes. Tenda does not assume any liability that may occur due to the use or application of the product described herein. Every effort has been made in the preparation of this document to ensure accuracy of the contents, but all statements, information and recommendations in this document do not constitute the warranty of any kind, express or implied.

Shortcut of Common Functions

How to access the Internet quickly using the Router?	Go
How to change your WiFi name and password?	Go
How to change your login password?	Go
How to enable/disable your WiFi according to schedule?	Go
How to extend your wireless range?	Go
How to control your Internet speed?	Go
How to prevent unknown device from connecting to your network?	Go

Contents

I Get to Know Your Router	1
1 Package Contents.....	1
2 LED Indicators	2
3 Buttons & Interfaces.....	3
4 Product Label.....	4
II Specify Your Internet Settings	6
1 Prepare Your Router	6
2 Position Your Router	7
3 Connect Your Router	9
Connect your Router to the Internet.....	9
Connect a computer to the Router.....	11
4 Access to the Router	13
5 Specify the Internet Settings.....	14
DHCP (Dynamic IP)	14
PPPoE.....	17
Static IP	19
6 Join Your WiFi.....	23
Windows 8	23
Windows 7	24
iPad/iPhone	25
Android	26
III Specify Advanced Settings	29
1 Internet Status.....	29
Change the Internet Type	29
Customize your WiFi name and password.....	37
Manage the attached device	39
2 Internet Settings.....	42
Select your connection type	42
3 Wireless Settings	43
WiFi Name & Password.....	43
WiFi Schedule.....	44
Wireless Repeating.....	45
Channel & Bandwidth.....	54
Signal Conditioning	55
WPS	56
4 Guest Network.....	59
To create a guest network:	59
5 Power Saving.....	60
To schedule the Router's working time:	60
6 USB Application.....	62
File Share	62

DLNA.....	68
Printer Service.....	79
7 VPN.....	84
PPTP Server.....	84
PPTP/L2TP Client.....	91
8 Advanced Settings.....	94
Parental Controls.....	94
Bandwidth Control.....	97
Smart LED.....	98
Tenda Cloud.....	99
Remote WEB.....	103
DDNS.....	104
Virtual Server.....	105
UPnP.....	107
IPTV.....	107
9 Administration.....	109
System Status.....	109
Login Password.....	110
LAN IP Settings.....	111
WAN Settings.....	113
Reboot.....	115
Firmware Upgrade.....	115
Back/Restore.....	117
Reset.....	117
System Log.....	118
Auto Maintenance.....	119
Time Setup.....	120
IV Appendix.....	121
1 Configure Your computer.....	121
Windows 8.....	121
Windows 7.....	122
Windows XP.....	124
2 FAQs.....	126
3 Technical Support.....	127
4 Safety and Emission Statement.....	128
CE Mark Warning.....	128
FCC Statement.....	128

I Get to Know Your Router

Before you connect to your Router, take a moment to become familiar with the package contents, product label, and the front and back panels. Pay particular attention to the LEDs on the front panel.

This section contains the following:

- ✧ [Package Contents](#)
- ✧ [LED Indicators](#)
- ✧ [Buttons & Interfaces](#)
- ✧ [Product Label](#)

1 Package Contents

Unpack the package. Your box should contain the following items:





- AC1900 Smart Dual-Band Gigabit WiFi Router * 1
- Power Adapter * 1
- Removable Stand * 1
- Ethernet Cable * 1
- Install Guide * 1





* If any item is incorrect, missing or damaged, please keep the original package and contact the vendor for replacement immediately.

2 LED Indicators



LED indicator description is shown as below after the device is powered on.

LED Indicator	Status	Description
Power 	Solid	The power is ON.
	Off	The power interface is not well-connected, or the Router malfunctions.
LAN 1/2/3 	Solid	The LAN port is well connected.
	Blinking	Data is being transmitted via interface.
	Off	No connection is detected on the LAN port.
Internet 	Solid	The Internet port is well-connected.
	Blinking	Data is being transmitted via interface.
	Off	No Ethernet cable is detected.
2.4GHz 	Solid	2.4GHz WiFi is enabled.
	Blinking	The Router is sending or receiving 2.4GHz WiFi data.
	Off	2.4GHz WiFi is disabled.

5GHz 	Solid	5GHz WiFi is enabled.
	Blinking	The Router is sending or receiving 5GHz WiFi data.
	Off	5GHz WiFi is disabled.
WPS 	Solid	WPS is enabled.
	Blinking	The Router is performing WPS negotiation to a client device, or transmitting data.
	Off	WPS is disabled.
USB 	Solid	A USB device is well-connected, and ready.
	Blinking	A USB device is plugged in, and is transmitting data.
	Off	No USB device is detected, or USB device is ejected safely.
SYS 	Blinking	The system is working fine.
	Off	The system is malfunctioning.

3 Buttons & Interfaces



➤ **WPS:** Press and hold it for about half a second and then release it to enable the WPS feature.

Within 2 minutes, enable the wireless device's WPS feature to establish WPS connection.

➤ **WiFi:** Press and then release it to enable/disable WiFi feature.

➤ **RST:** Press and hold it with some needle-like things for about 8 seconds until all the LEDs light up once and then release it to reset the Router to factory default settings.

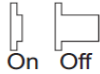

- **Power on/off:** Push it to turn on/off the power supply. 
- **Power:** Power Connector. Insert the included power adapter into this connector.
- **USB3.0:** USB3.0 port. USB3.0 can be used to connect to a USB storage drive, USB printer, and etc.
- **Internet:** WAN port. Connect an Ethernet cable from the Internet side to this port for Internet access.
- **1/2:** LAN port. Connect a network device (computer, XBOX, etc.) to this port.
- **3:** Port 3 is used for IPTV only when IPTV feature is enabled; otherwise, it serves as a LAN port.

4 Product Label

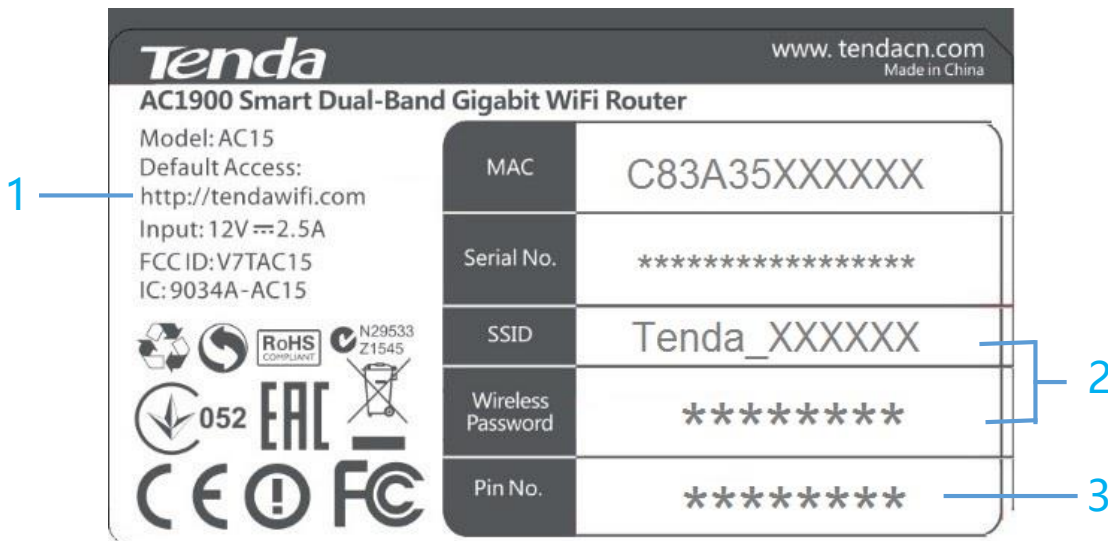

*This label can be found on the rear panel of the Router.

1. Default Access: <http://tendawifi.com>

The default login domain name of the Router. Type the domain name in the address bar of a web browser to log in to the Router's Quick Setup Wizard or User Interface (Only when you access the Router at the first time, or restore the Router to factory default, can the Router log in to the Router's Quick Setup Wizard).

The **default login IP address** is **192.168.0.1**, you can also type 192.168.0.1 in the address bar of a web browser to log in to the Router's Quick Setup Wizard or User Interface.

2. SSID/ Wireless Password: The default 2.4GHz wireless network name (WiFi Name) and the WiFi password (security key). Your Router is preset with a unique WiFi Name and WiFi password.

3. Pin NO.: The required number when you establish a WPS connection.

II Specify Your Internet Settings

This Chapter will instruct you to position, connect and configure your Router.

This section contains the following:

- ✧ [Prepare Your Router](#)
- ✧ [Position Your Router](#)
- ✧ [Connect Your Router](#)
- ✧ [Access to the Router](#)
- ✧ [Specify the Internet Settings](#)
- ✧ [Join Your WiFi](#)

1 Prepare Your Router

Mount the removable stand on the router.

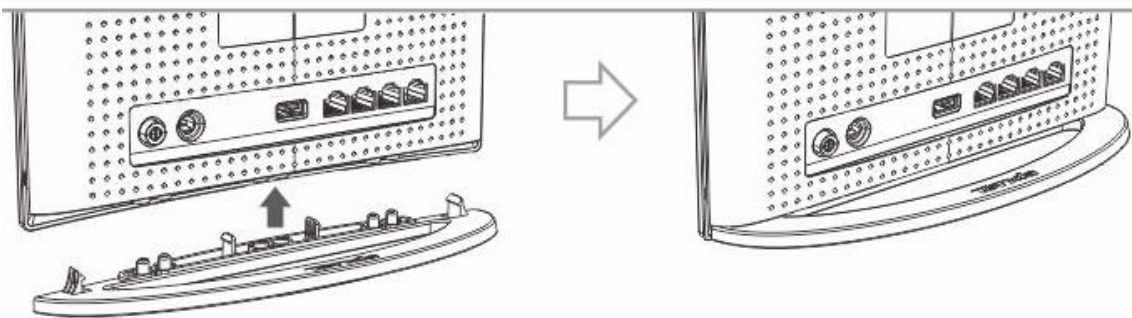

For best wireless signal, orient the three antennas as shown in the figure below:

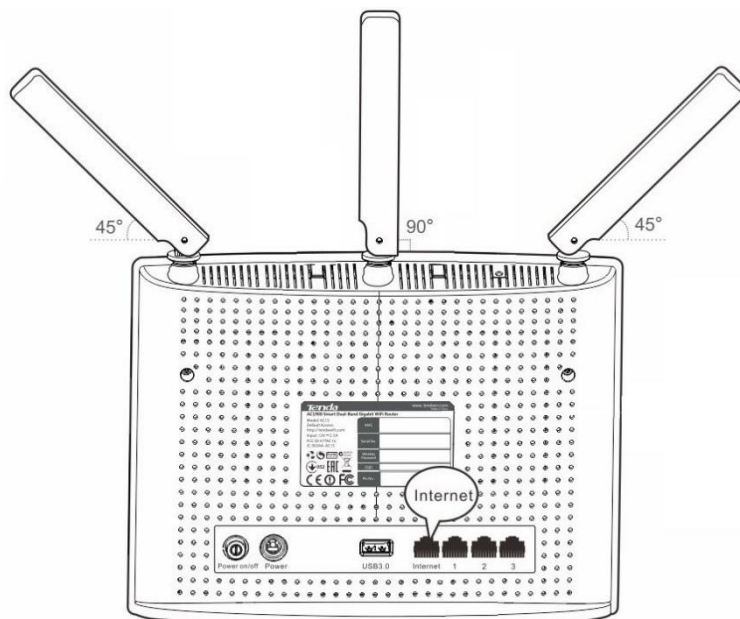

2 Position Your Router

The Router lets you access the Internet anywhere within the operating range of your wireless network. However, the operating range of your wireless connection can vary significantly depending on the physical placement of your Router.

And pay attention to the followings:

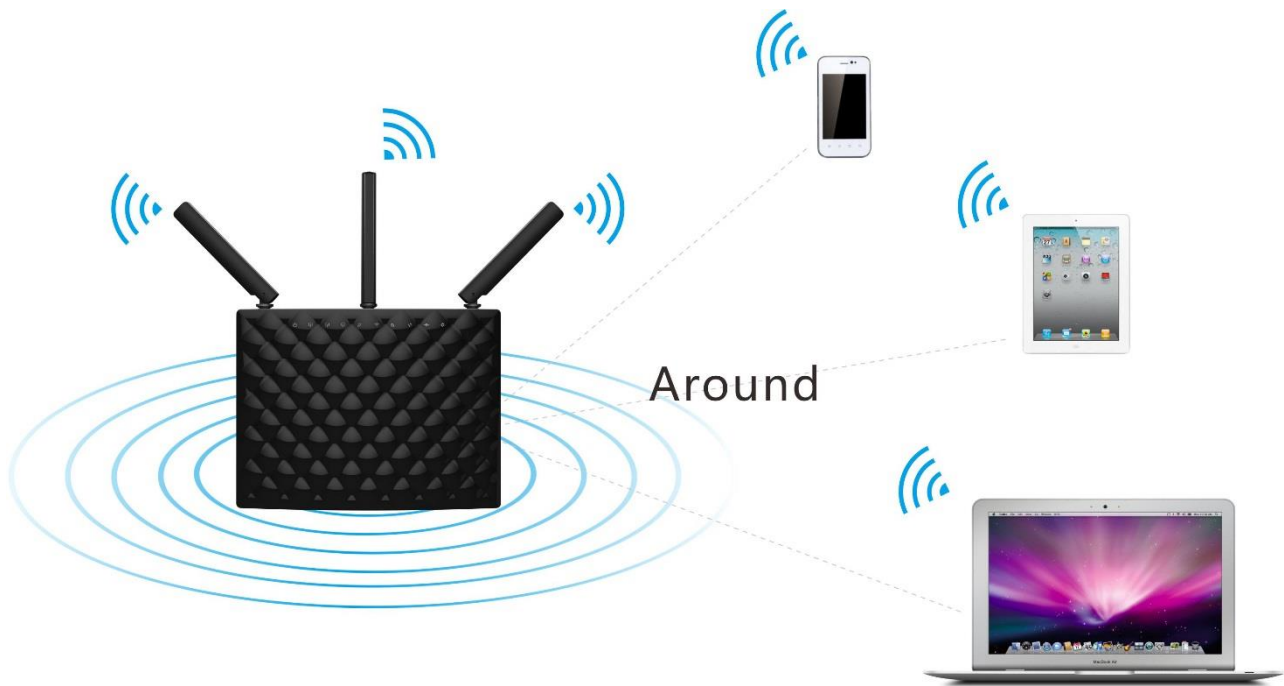

➤ Place it around the central area which your laptops, smart phones and other devices usually surround, and preferably within line of sight to your wireless devices.



- Put it on an elevated spot such as a high shelf, keeping the number of walls and ceilings to a minimum between the Router and other clients such as computers and smart phones.



- Keep it away from electrical devices that are potential sources of interference, such as ceiling fans, home security systems or microwaves.
- Keep it away from any large metal surfaces, such as a solid metal door or aluminum studs.
- Keep it away from other materials such as glass, insulated walls, fish tanks, mirrors, brick, and concrete that may also affect your wireless signal.

3 Connect Your Router

Connect your Router to the Internet

Select [type 1](#) if a modem is required for your Internet access, and select [type 2](#) if you access the Internet via an Ethernet cable.

Type 1: Telephone Line/FTTH (Fiber To The Home)/Cable Access

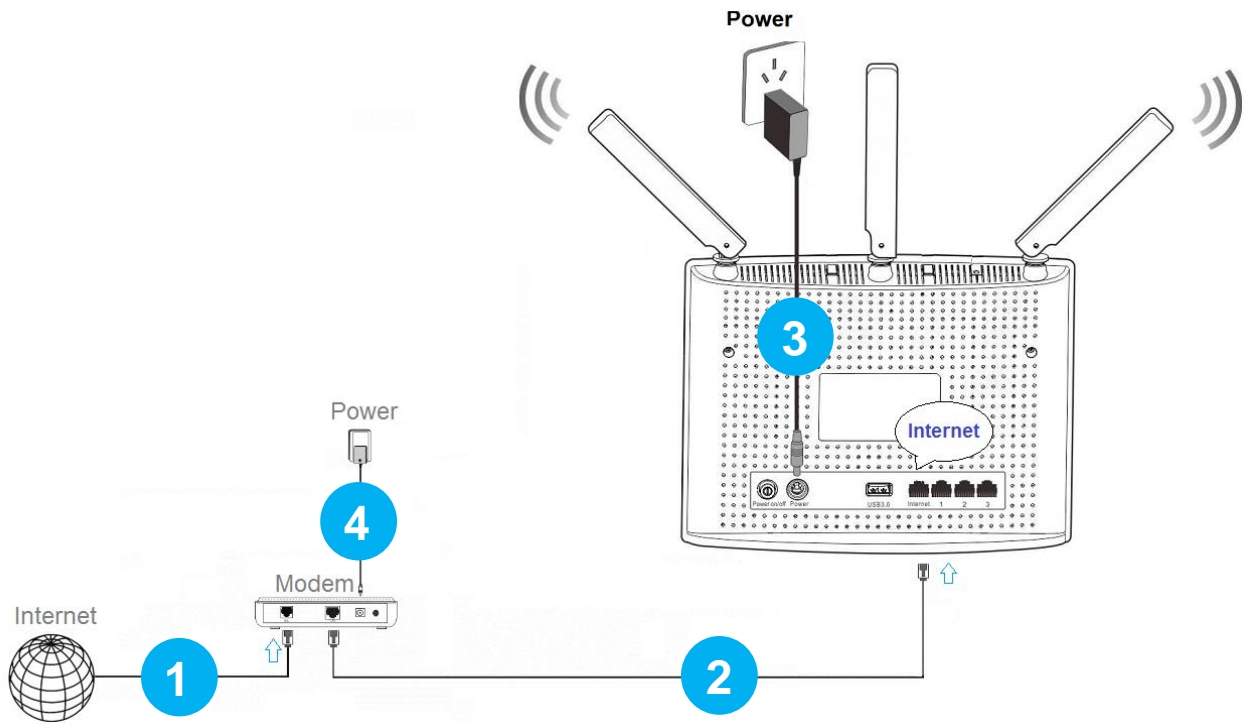

- 1 Connect the cable (prepared by yourself) from the Internet side to your modem.
- 2 Connect the modem to the WAN port of the Router.
- 3 Insert the power adapter to your Router's Power port, and plug the other end to a power outlet.
- 4 Insert your modem's power adapter to the power interface, and plug the other end to a power outlet.

Type 2: Ethernet Cable Access

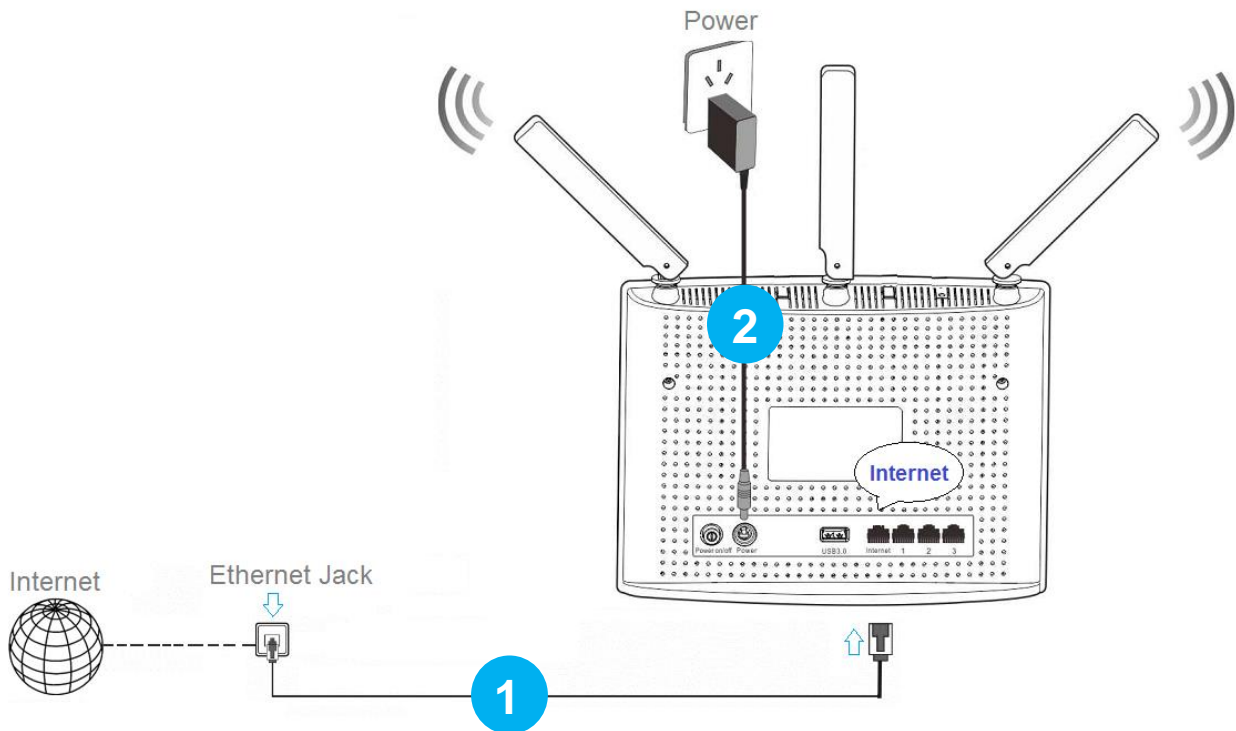

- 1 Insert the Ethernet cable from the Internet side into the WAN port of the Router.
- 2 Insert the power adapter to your Router's Power port, and plug the other end to a power outlet.

Connect a computer to the Router

Select **wired** or **wireless** connection as you like to connect your computer to the Router.

Type 1: Wired Connection

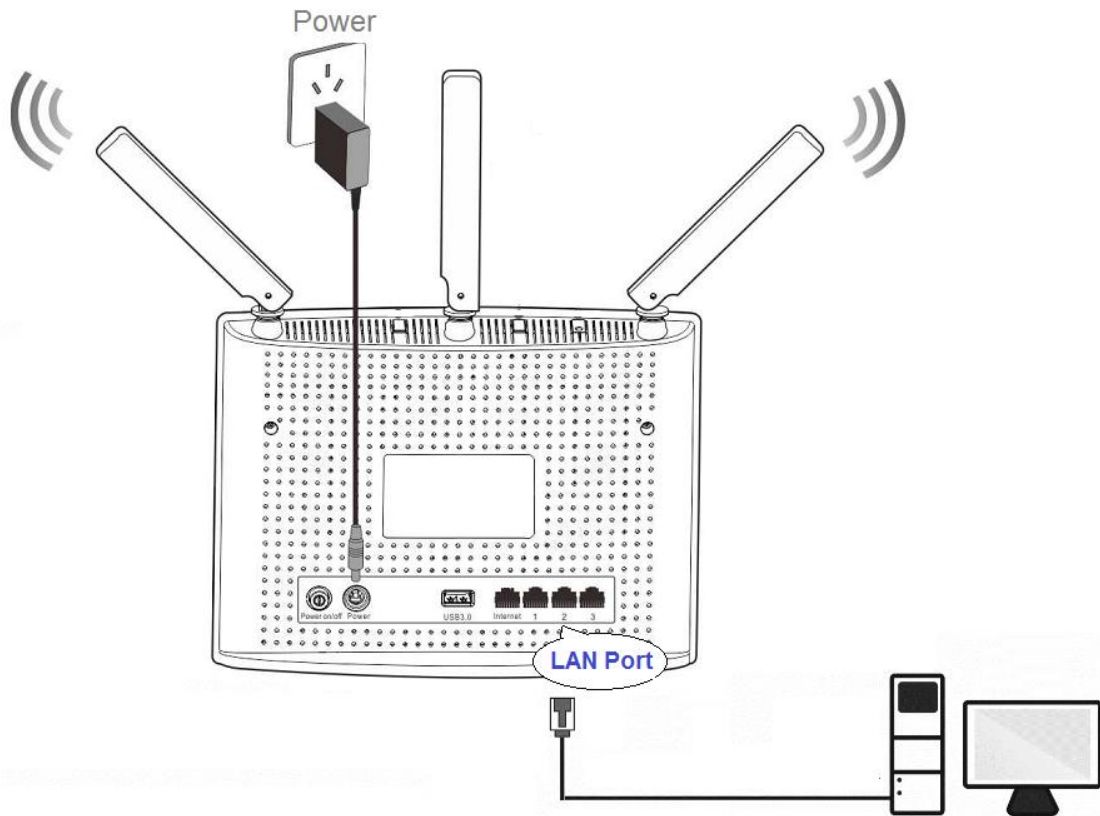

Connect an Ethernet cable (included in the packet) to the Ethernet port of your computer, and insert the other end of the Ethernet cable into 1/2/3 port of the Router.

Type 2: Wireless Connection

Tenda www.tendacn.com
Made in China

AC1900 Smart Dual-Band Gigabit WiFi Router

Model: AC15
 Default Access: <http://tendawifi.com>
 Input: 12V ⚡ 2.5A
 FCC ID: V7TAC15
 IC: 9034A-AC15

MAC	C83A35XXXXXX
Serial No.	*****
SSID	Tenda_XXXXXX
Wireless Password	*****
Pin No.	*****

The default WiFi name and password can be found on the product label.

* This product label is on the router's back panel.

Procedure: On your computer with wireless adapter or other wireless devices, find and select the Router's WiFi name, enter the wireless password, and then join it.



Tips

1. If you don't know how to join your WiFi, please refer to [5 Join Your WiFi](#).
2. Either WiFi (SSID) or WiFi password is changed, devices are required to reconnect with WiFi manually once again.
3. The devices can only access the Internet after you finish Internet configuration.

4 Access to the Router

Launch a web browser on your connected computer, say IE, the Router's **Quick Setup Wizard** page below will appear. If not, enter *http://tendawifi.com* or *192.168.0.1* in the address bar, and tap **Enter** on the keyboard.



Tips

If the Router's **Quick Setup Wizard** page doesn't appear after the operation above when you access the Router at the first time, please refer to the solutions in **FAQ > Q1**.

5 Specify the Internet Settings

After the steps above, you will log in to the Router's Quick Setup Wizard if you access the Router at the first time or restore your Router to factory default. Click **Start**. The Router will detect your connection type automatically.



Follow the corresponding steps to complete the Internet settings according to your Router's detection result.

[DHCP \(Dynamic IP\)](#)

No need to dial up as detected

[Next](#)

[PPPoE](#)

Please enter the ISP Username and Password

[Next](#)

[Skip](#)

[Static IP](#)

Your connection type may be static IP as detected. Please set up it manually in the Internet Settings page.

[Next](#)

DHCP (Dynamic IP)

1 If the following page appears, it indicates that your connection type is dynamic IP (DHCP). No parameter is required, just click **Next** to continue.

No need to dial up as
detected

Next

2 This page allows you to customize your WiFi name, WiFi password, and login password.

Customize your WiFi name, password, and login password, then click **Next** to continue.



Tips

1. Note that the WiFi password is used to connect to your wireless network (WiFi) while the login password is for logging in to the Router's User Interface. You can check the option in front of **Set up the login password to the same as the WiFi password** to set them to the same. Or uncheck it to set them to different ones respectively.

2. The Router provides two types of frequency bands: 2.4GHz and 5GHz. 5GHz WiFi name can only be searched by 5GHz available wireless devices.

When you click the **Next** button in the page below, the 5GHz WiFi name will be changed into the same one as that of 2.4GHz WiFi name except the suffix “_5G”, for example, the 2.4GHz WiFi name is Tenda_000118, the 5GHz WiFi name will be Tenda_000118_5G.

Wireless Settings

Set up the login password to the same as the WiFi password

[Next](#)

3 When the following page appears, it indicates that you can access the Internet now. If you want to experience more features, click **Advanced**, type login password you set up just now, and click **Login** to log in to the Router's user Interface.



You're all set! You can now connect to

Tenda_000118
or **Tenda_000118_5G**

For additional features or to change settings, click on the "Advanced" button below.

[Advanced](#)



The image shows a Tenda login page. At the top center is the Tenda logo in orange. Below the logo is a language selection dropdown menu with a globe icon and the text "English". Underneath is a password input field with a key icon and the placeholder text "Please enter the login password.". Below the password field is an orange "Login" button. At the bottom left of the form area is a link that says "Forgot password?" with a small downward arrow.

PPPoE

- 1 Type the user name and password your Internet Service Provider provided, and click **Next**.

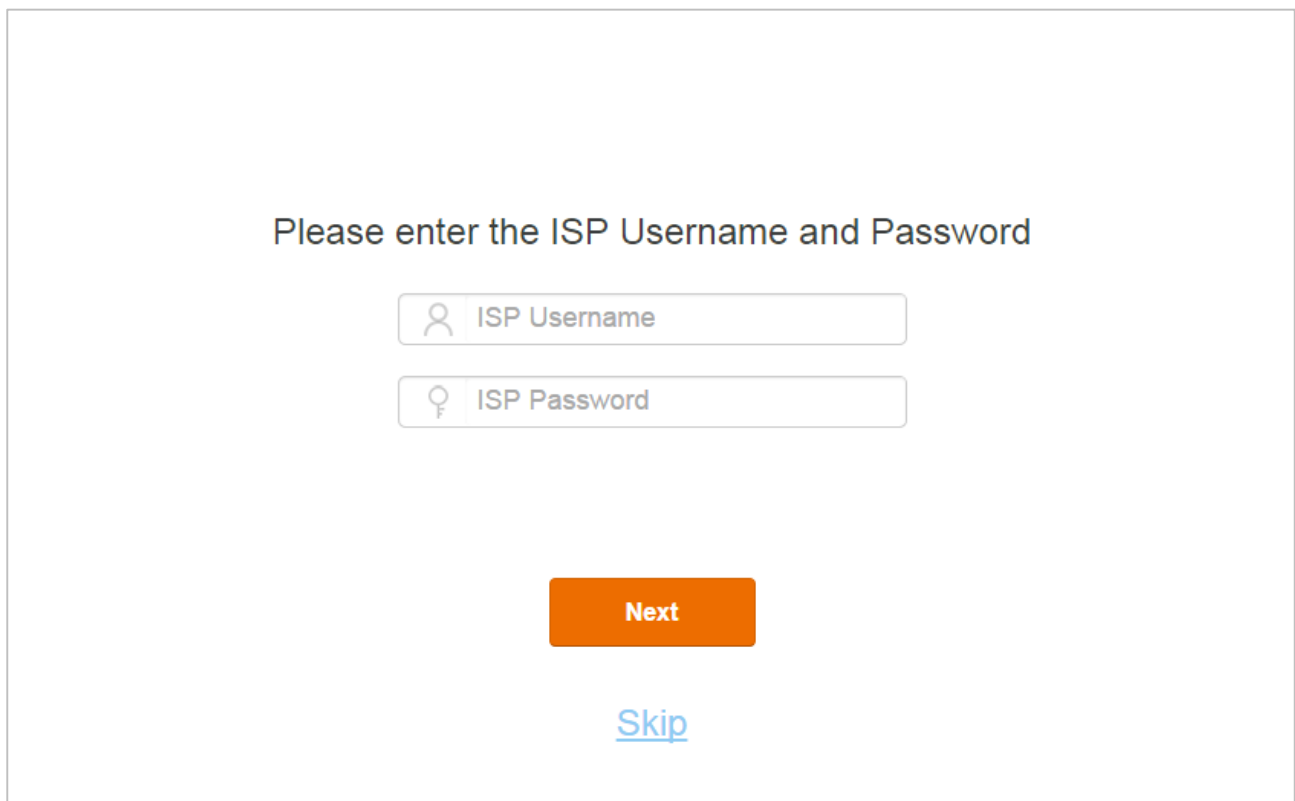

The image shows a PPPoE configuration page. At the top center, the text reads "Please enter the ISP Username and Password". Below this text are two input fields. The first field has a person icon and is labeled "ISP Username". The second field has a key icon and is labeled "ISP Password". Below the input fields is an orange "Next" button. At the bottom center of the page is a blue, underlined link that says "Skip".

2 Customize your WiFi name, password, and login password, then click **Next** to continue.

 Tips

1. Note that the WiFi password is used to connect to your wireless network (WiFi) while the login password is for logging in to the Router's User Interface. You can check the option in front of **Set up the login password to the same as the WiFi password** to set them to the same. Or uncheck it to set them to different ones respectively.

2. The Router provides two types of frequency bands: 2.4GHz and 5GHz. 5GHz WiFi name can only be searched by 5GHz available wireless devices.

When you click the **Next** button in the page below, the 5GHz WiFi name will be changed into the same one as that of 2.4GHz WiFi name except the suffix “_5G”, for example, the 2.4GHz WiFi name is Tenda_000118, the 5GHz WiFi name will be Tenda_000118_5G.

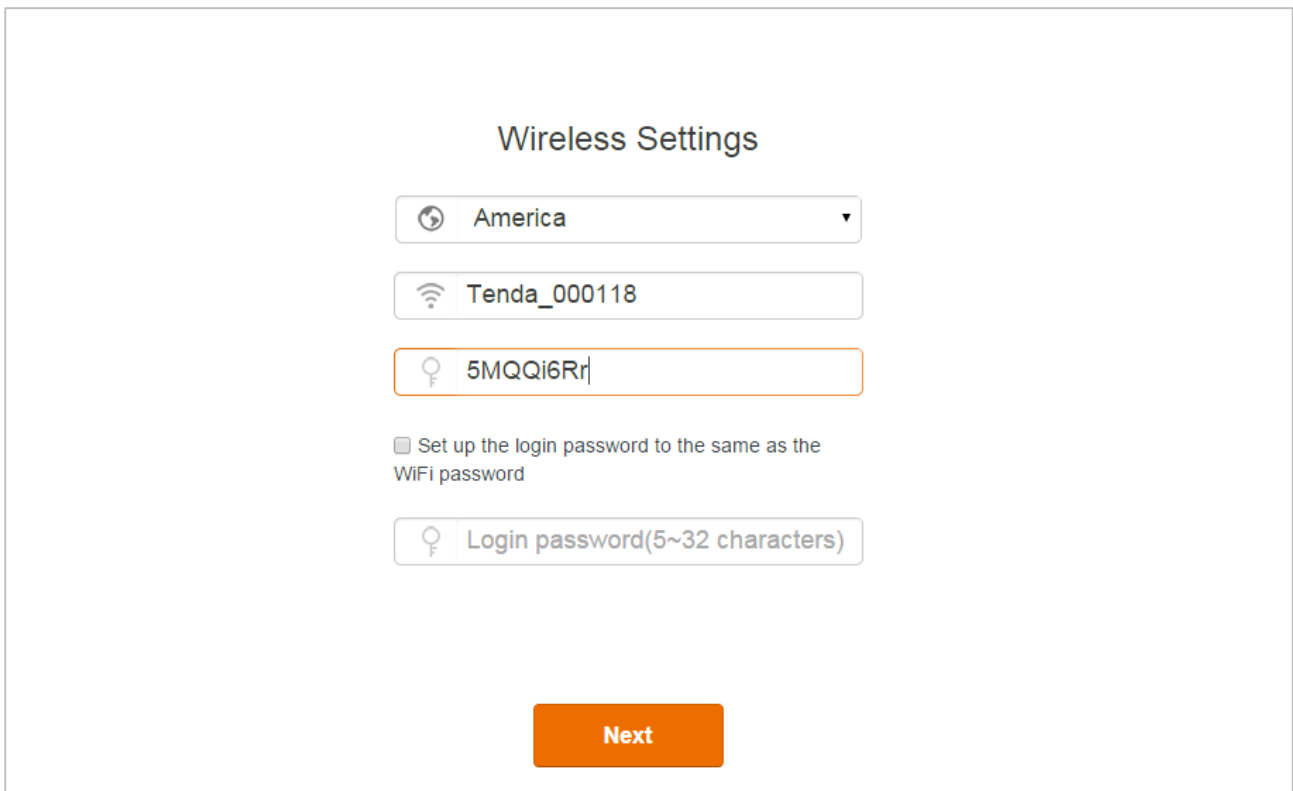

Wireless Settings

America

Tenda_000118

5MQQi6Rr|

Set up the login password to the same as the WiFi password

Login password(5~32 characters)

Next

3 When the following page appears, it indicates that you can access the Internet now. If you want to experience more features, click **Advanced**, type login password you set up just now, and click **Login** to log in to the Router's user Interface.



You're all set! You can now connect to

Tenda_000118
or **Tenda_000118_5G**

For additional features or to change settings, click on the "Advanced" button below.

Advanced

Tenda



English ▼



Please enter the login password.

Login

Forgot password? ▼

Static IP

1 If the following page appears, it indicates that your connection type is Static IP. Click **Next** to

continue.

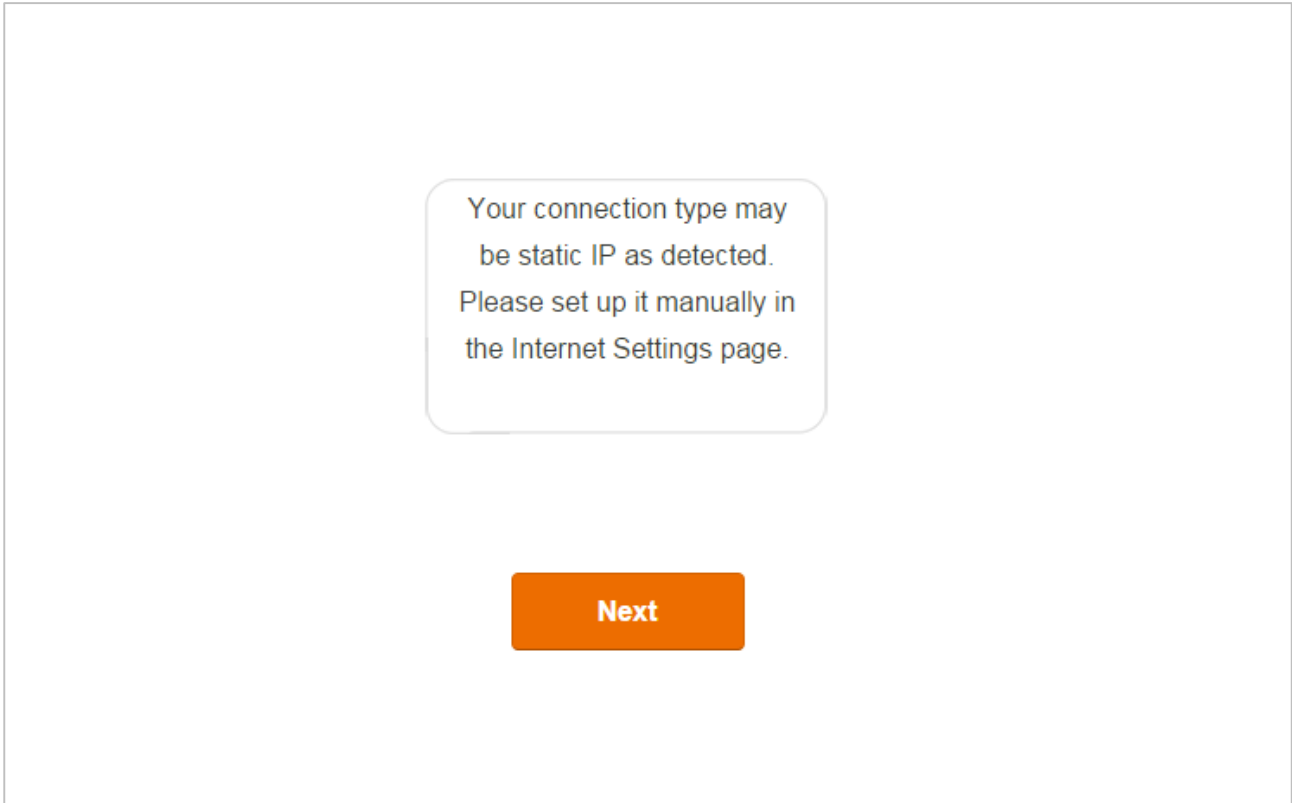

2 Customize your WiFi name, password, and login password, then click **Next** to continue.



Tips

1. Note that the WiFi password is used to connect to your wireless network (WiFi) while the login password is for logging in to the Router's User Interface. You can check the option in front of **Set up the login password to the same as the WiFi password** to set them to the same. Or uncheck it to set them to different ones respectively.

2. The Router provides two types of frequency bands: 2.4GHz and 5GHz. 5GHz WiFi name can only be searched by 5GHz available wireless devices.

When you click the **Next** button in the page below, the 5GHz WiFi name will be changed into the same one as that of 2.4GHz WiFi name except the suffix “_5G”, for example, the 2.4GHz WiFi name is Tenda_000118, the 5GHz WiFi name will be Tenda_000118_5G.

Wireless Settings

 America 

 Tenda_000118

 5MQQi6Rr|

Set up the login password to the same as the WiFi password

 Login password(5~32 characters)

Next

2

Connecting...please wait...

3 Type the login password you set just now, and click **Login**.

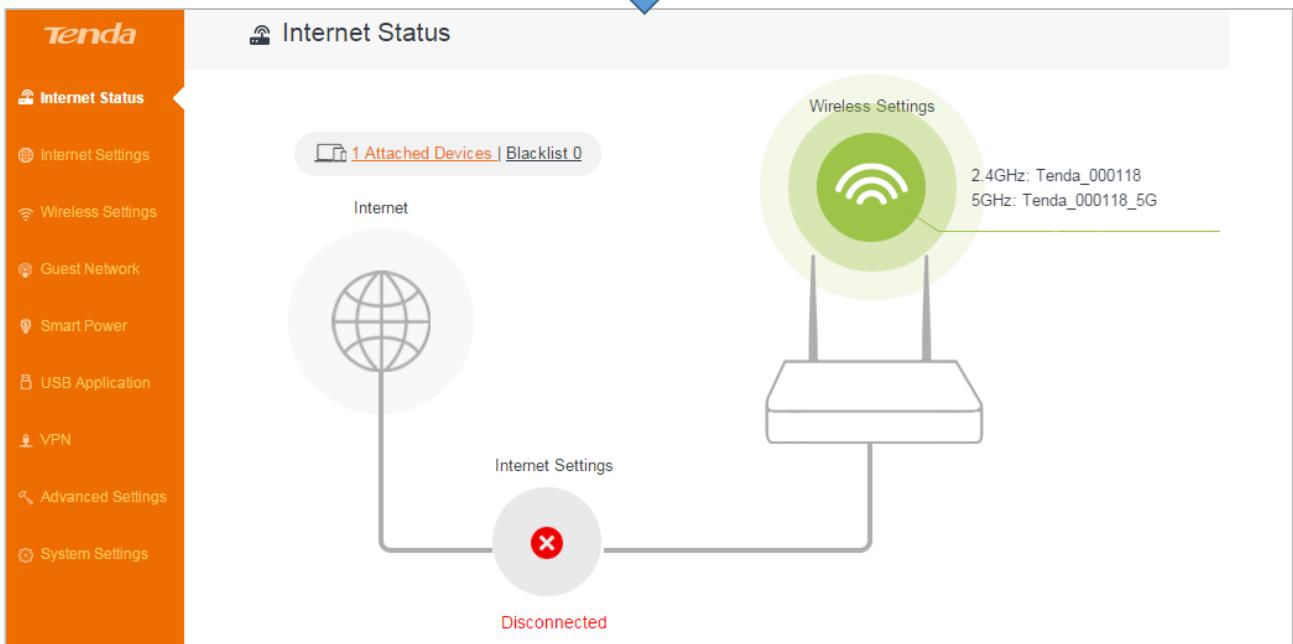
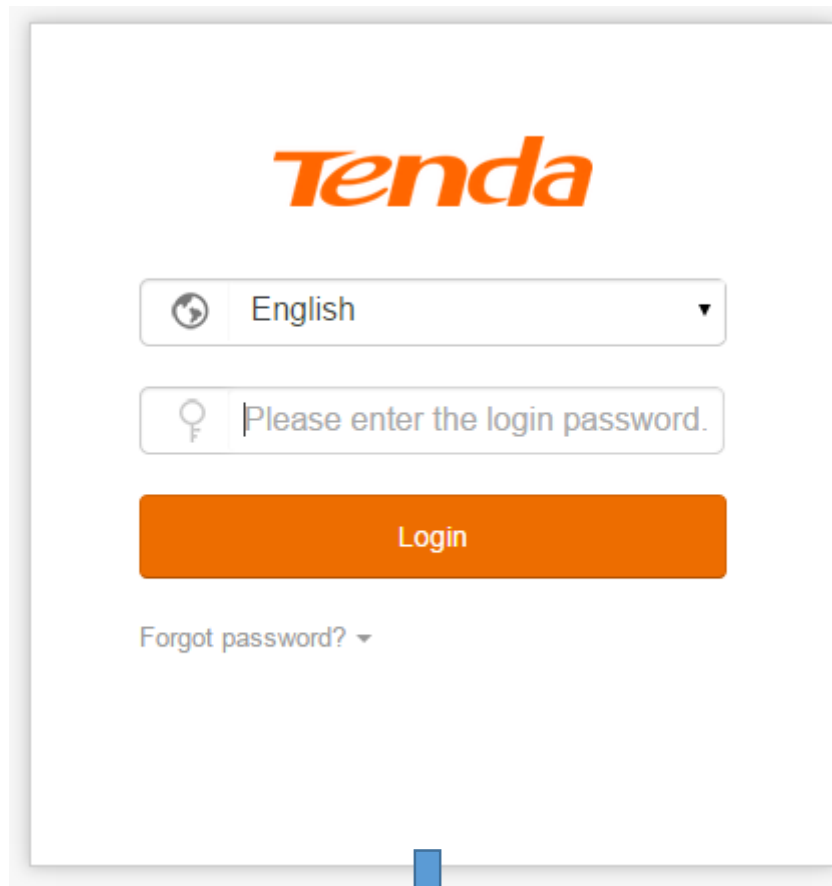

4 Click **Internet Settings**.

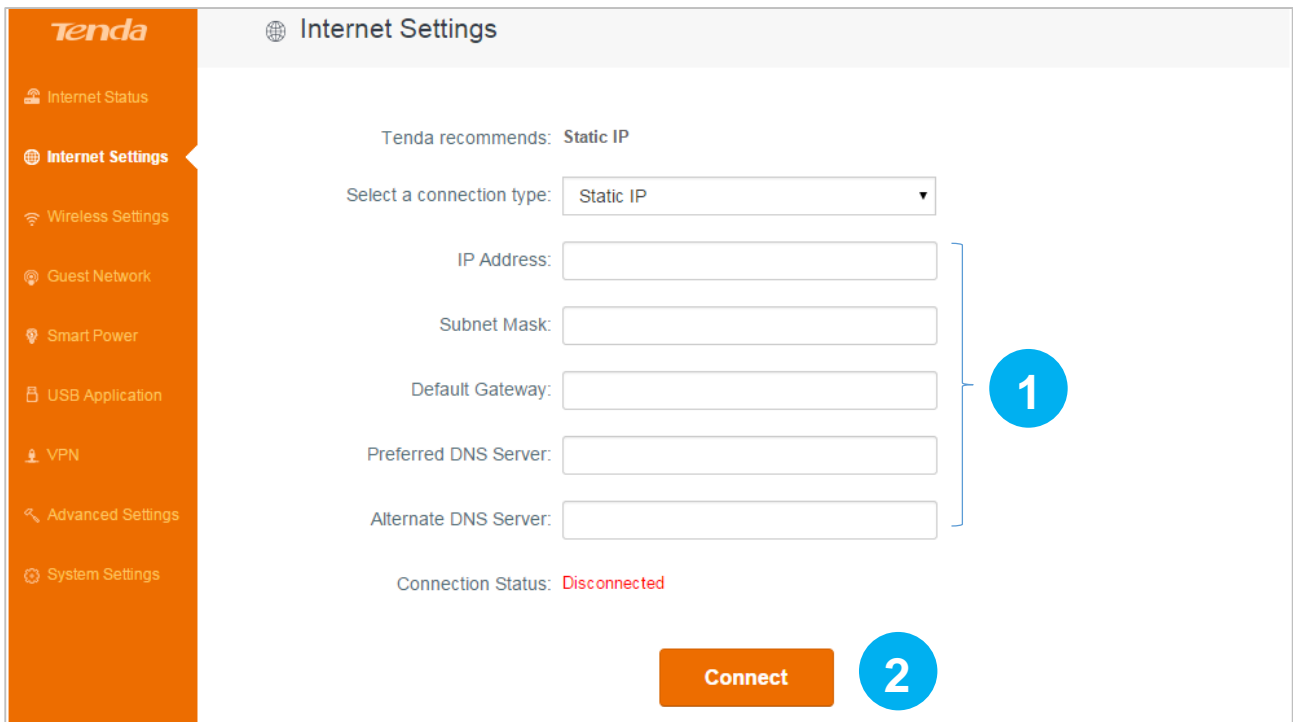

1. Type the static IP, subnet mask, default gateway, and preferred DNS server provided by your Internet Service Provider.

2. Click **Connect**.

Then you can enjoy your wired or wireless network, or go forward to customize more settings.

6 Join Your WiFi

This part instructs you how to connect to your wireless network via your notebook or other wireless devices. We take [Windows 8](#), [Windows 7](#), [iPad/iPhone](#), and [Android](#) as examples here. Choose the corresponding configuration steps according to your needs.

Windows 8

1 Click the icon  on the bottom right corner of your desktop.



💡 Tips

1. If you cannot find the icon , please move your cursor to the top right corner of your desktop, select **Settings > Control Panel > Network and Internet > Network and Sharing Center > Change adapter settings**, right click **Wi-Fi** and select **Connect/Disconnect**.
2. If you cannot find your WiFi from the list, ensure the Airplane Mode is not enabled on your computer.

- 2 Select your WiFi from the list, click **Connect** and then follow onscreen instructions.
- 3 **Connected** successfully.

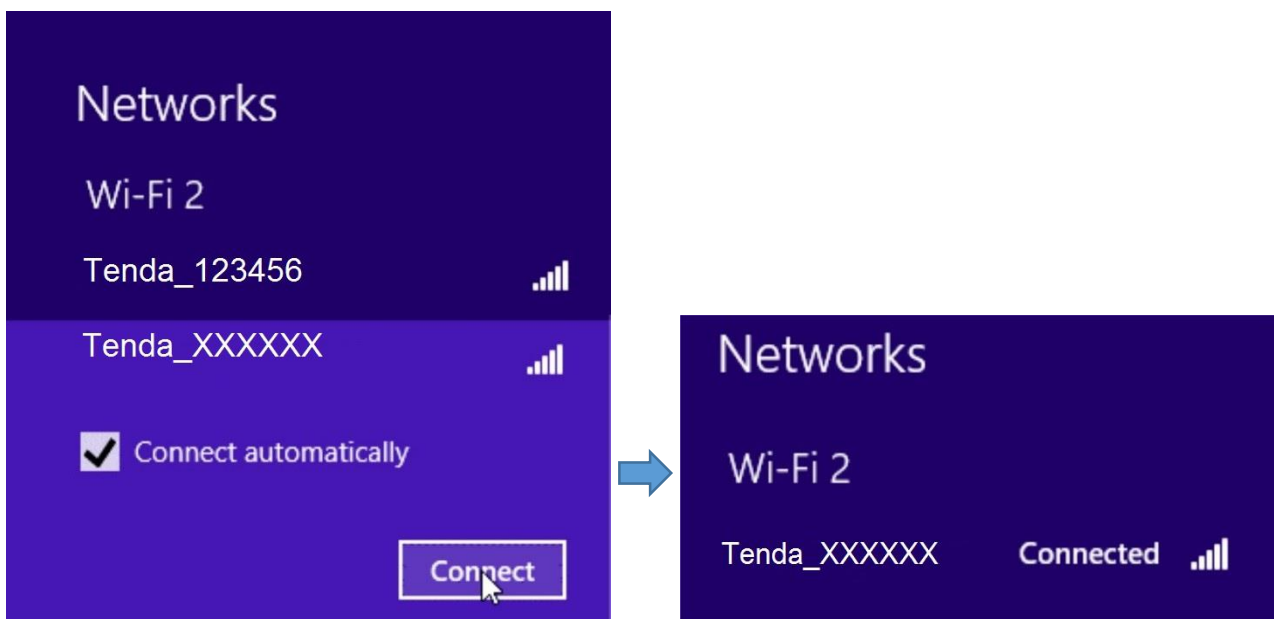

Windows 7

- 1 Click the icon  on the bottom right corner of your desktop. Select your WiFi from the list, click **Connect** and then follow onscreen instructions.



💡 Tips

If you cannot find the icon , please move your mouse to the bottom left corner of your desktop, select **Start > Control Panel > Network and Internet > Network and Sharing Center > Change adapter settings**, right click **Wireless Network Connection** and select **Connect/Disconnect**.

2 **Connected** successfully.

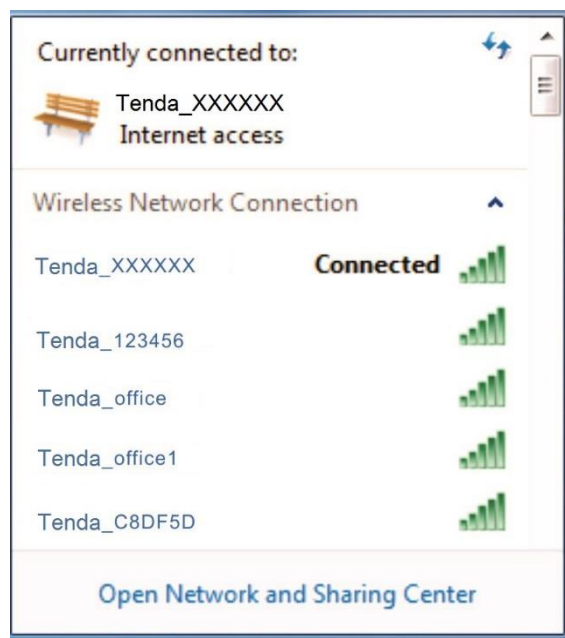

iPad/iPhone

1 Click on **Settings**.

2 Click **Wi-Fi**, and choose your SSID.

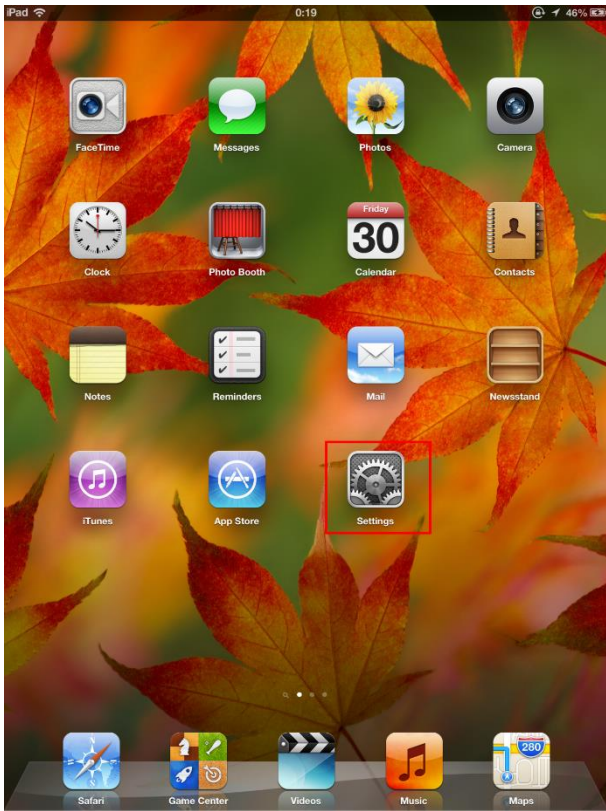

3 Enter your Wireless password, and click **Join**.

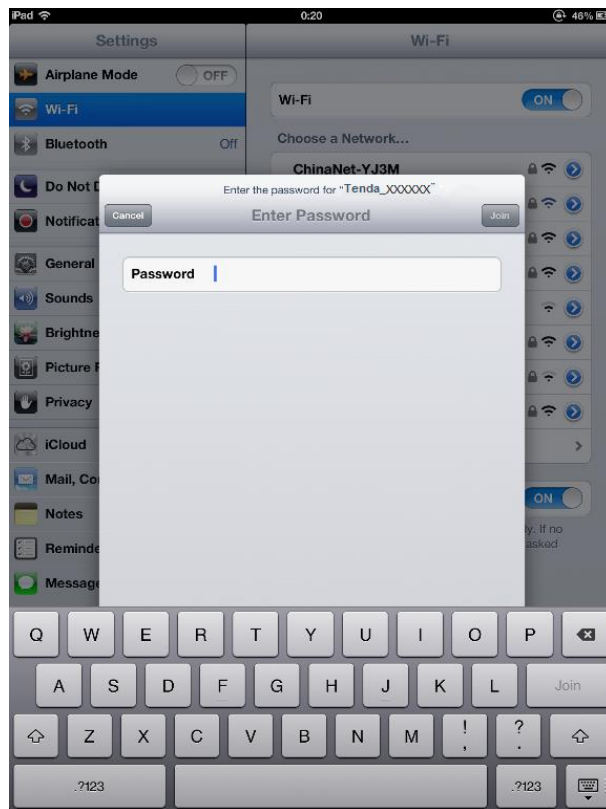

Android

1 Click on **Settings**.

2 Click **WLAN** to enter your WLAN settings.



3 Enable your **WLAN**, and select your SSID. **4** Enter your wireless password, and click **Connect**.

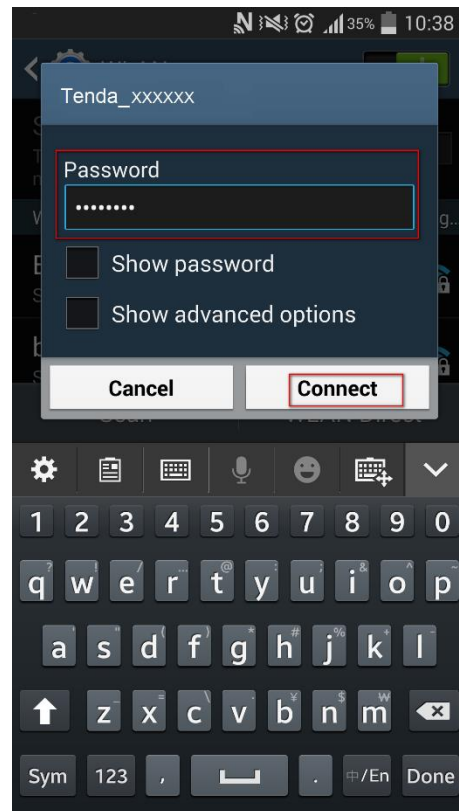

5 When your WiFi is connected successfully, it will display **Connected**.

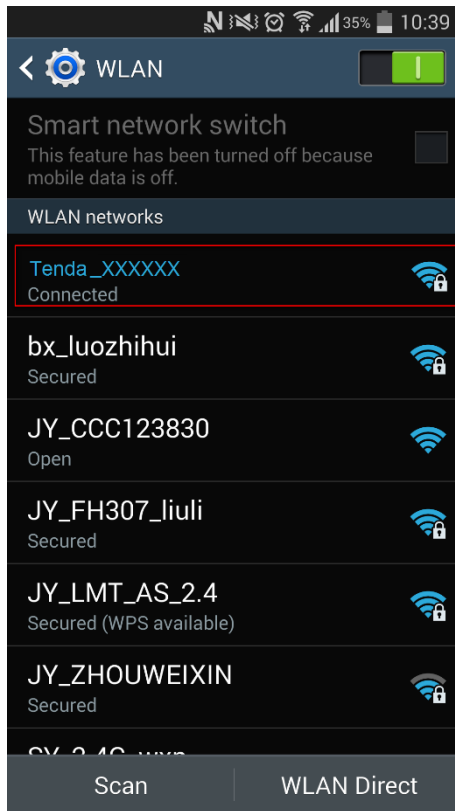

III Specify Advanced Settings

This Chapter describes the advanced features of your Router, such as Guest Network, Smart Power, USB Application, and etc.

Click the following icons (shortcut) to go to the corresponding features.

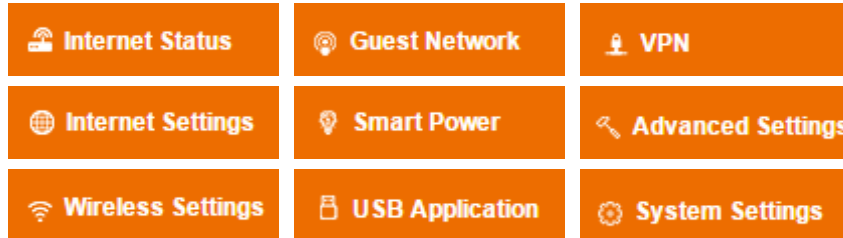

1 Internet Status

In Internet Status page, you can check the Internet connection status, WiFi Info, and the connected devices' info. Meanwhile, this part offers three shortcuts for you to change the Internet type and wireless settings, and allows you to manage the connected devices.

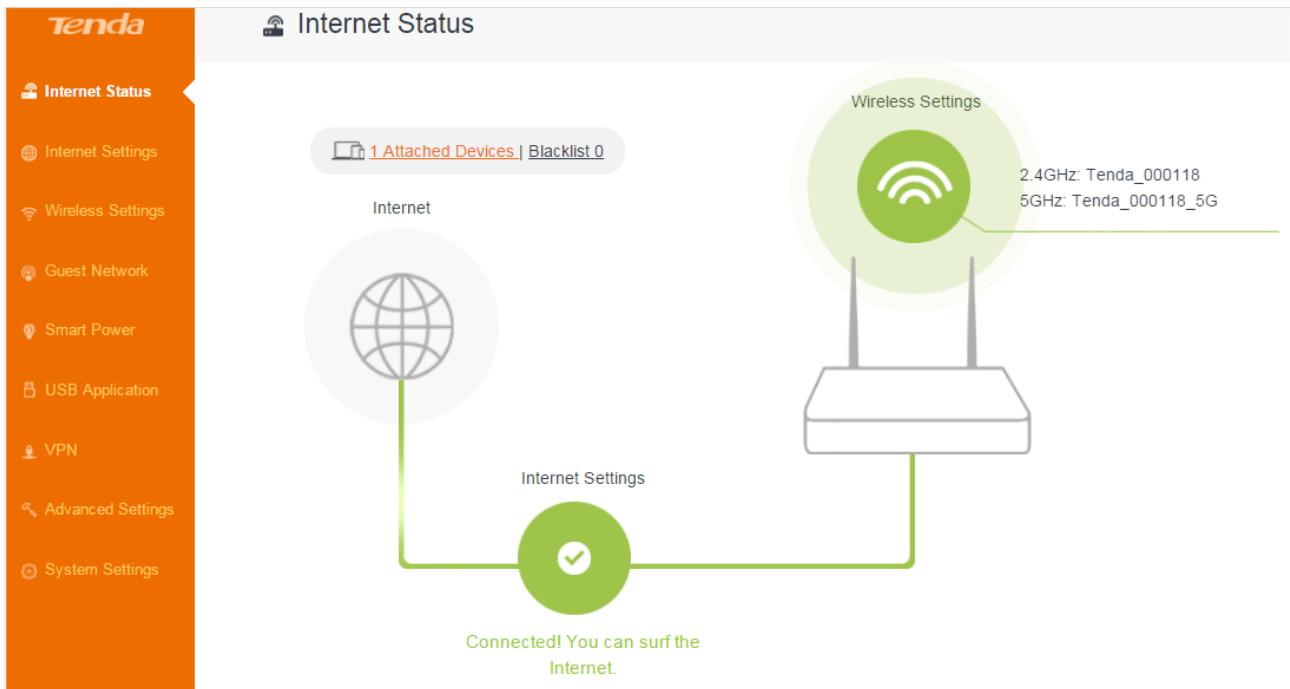

Change the Internet Type

If you don't set up your Internet connection by following Quick Setup Wizard, or want to change your Internet settings, you can refer to the following instructions.

Click the Internet Settings' gray roundness in the page, and then the Internet Settings page will pop up.

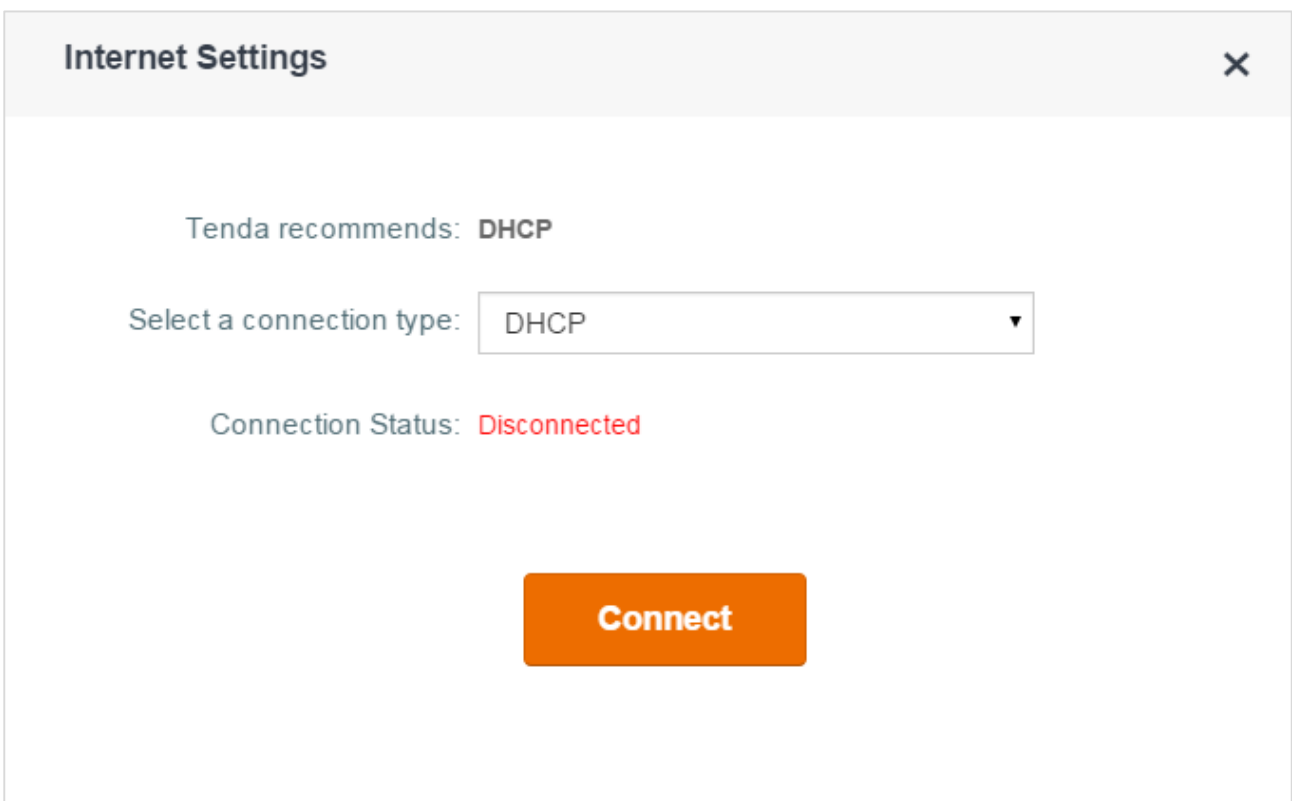
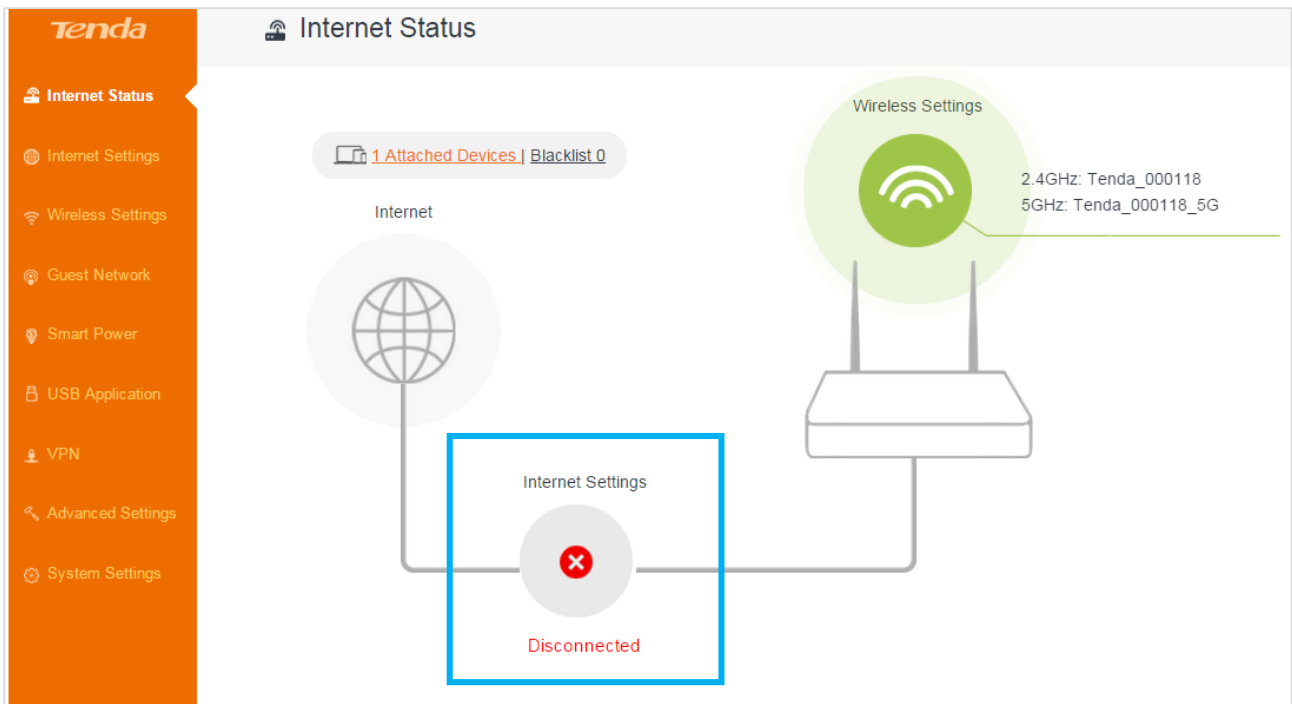

Tenda recommends: This field shows the Internet type the Router detected.

Select a connection type: There are three types of Internet connection on the **Internet Settings** page: DHCP, Static IP, and PPPoE.

Refer to the instructions in the form below to select your Internet connection type.

Connection Type	The parameters your Internet Service Provider provided for Internet access
PPPoE	User name and password.
DHCP (Dynamic IP)	Nothing.
Static IP	Static IP address, subnet mask, gateway, DNS server.

Connection Status: It displays the current connection status.

DHCP

Select **DHCP** and click **Connect**.

Internet Settings
✕

Tenda recommends: **DHCP**

Select a connection type:

Connection Status: Disconnected

Check the **Connection Status**. If it displays **Connected! You can surf the Internet**, it indicates you can access the Internet now.

Internet Settings

Tenda recommends: **DHCP**

Select a connection type:

Connection Status: **Connected! You can surf the Internet.**

Connected Time: 4s

Disconnect

And the Internet Settings' gray roundness will turn green.

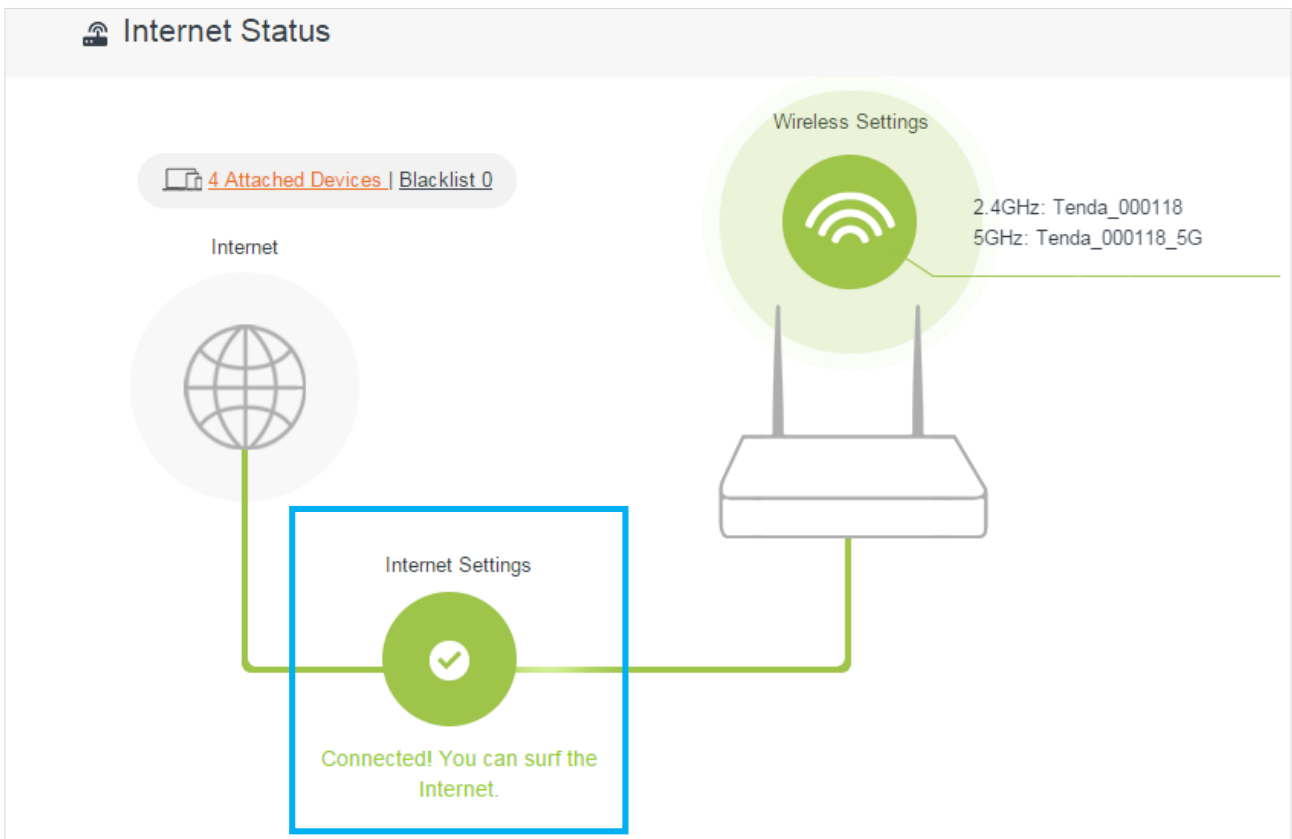

PPPoE

Internet Settings

Tenda recommends: **PPPoE**

Select a connection type:

ISP Username:

ISP Password:

Connection Status: **Disconnected**

Connect

1. Select **PPPoE**.
 2. Enter the user name and password provided by your ISP in the **ISP Username** and **ISP Password** field.
 3. Click **Connect**.
- Check the **Connection Status**. If it displays **Connected! You can surf the Internet**, it indicates you can access the Internet now.

Internet Settings

Tenda recommends: **PPPoE**

Select a connection type:

Connection Status: **Connected! You can surf the Internet.**

Connected Time: 13s

Disconnect

And the Internet Settings' gray roundness will turn green.

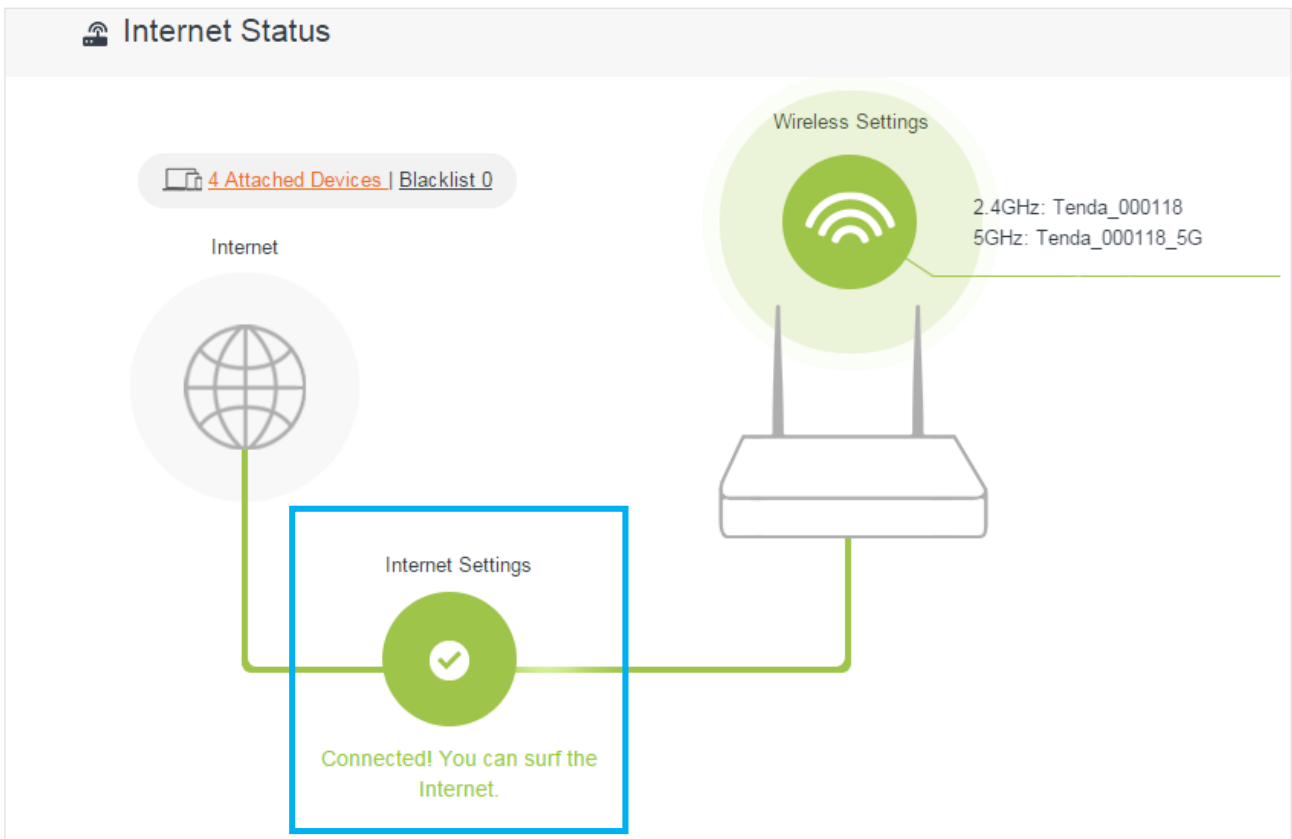

Static IP

Internet Settings ✕

Tenda recommends: **Static IP**

Select a connection type:

IP Address:

Subnet Mask:

Default Gateway:

Preferred DNS Server:

Alternate DNS Server:

Connection Status: **Disconnected**

Connect

1. Select **Static IP**.
2. Enter the Static IP and other parameters provided by your ISP in the corresponding field.
3. Click **Connect**.

Check the **Connection Status**. If it displays **Connected! You can surf the Internet**, it indicates you can access the Internet now.

Internet Settings

Tenda recommends: **Static IP**

Select a connection type:

Connection Status: **Connected! You can surf the Internet.**

Connected Time: 15s

Disconnect

And the Internet Settings' gray roundness will turn green.

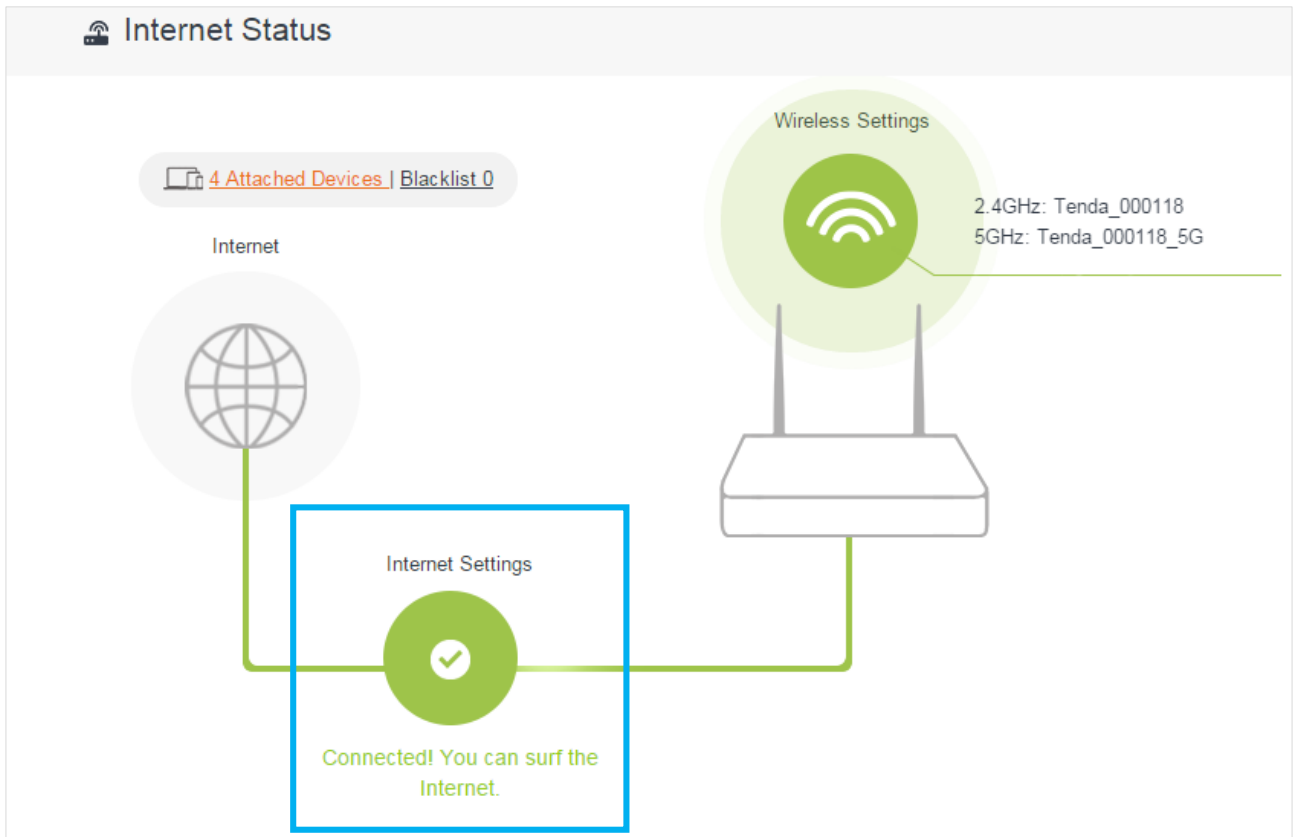

Customize your WiFi name and password

Click the Wireless Settings' green roundness on the upper right, and then the Wireless Settings page will pop up.

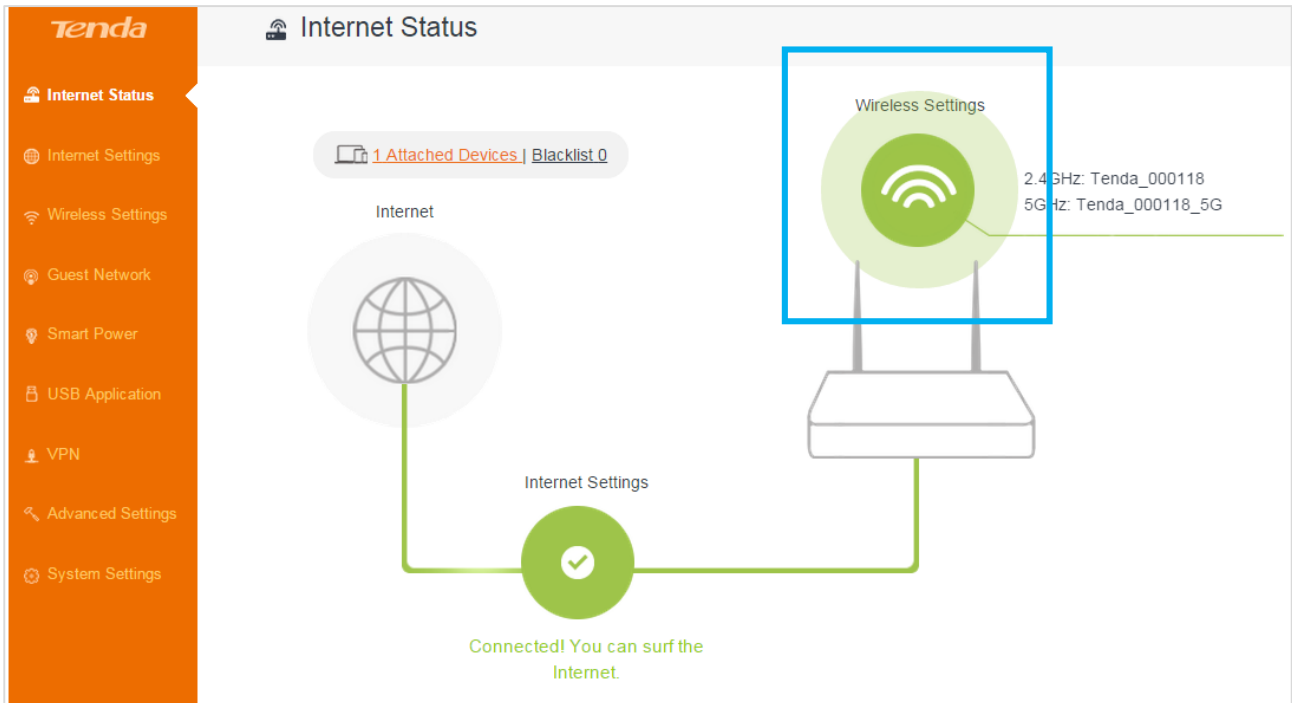

Wireless Settings ✕

2.4GHz

WiFi Name: Hide

Password: No Password

5GHz

WiFi Name: Hide

Password: No Password

Save

👉 WiFi Name & WiFi Password

The Router provides two types of frequency bands: 2.4GHz and 5GHz. You can assign a unique name containing up to 32 characters for WiFi name, and customize a password containing up to 63 characters for WiFi password. Note them down if you change the default one avoid forgetting it.

👉 Hide

If the **Hide** option is checked, the wireless clients cannot search the WiFi name of the Router. You need know the WiFi name in advance and enter the WiFi name on each wireless client manually.

👉 No Password

If the **No Password** option is checked, there is no password for your WiFi. The wireless client can join in your wireless network by selecting your WiFi name without entering any password. It poses safe risk to your network. So **DO NOT** check this option if unnecessary. But in some case, for example, the Router is used in a small café shop, and you want to share the wireless network with your customers without requiring a WiFi password. Then you can check the **No password** option.

Manage the attached device

Click **Attached Devices**, the attached devices' info will pop up.

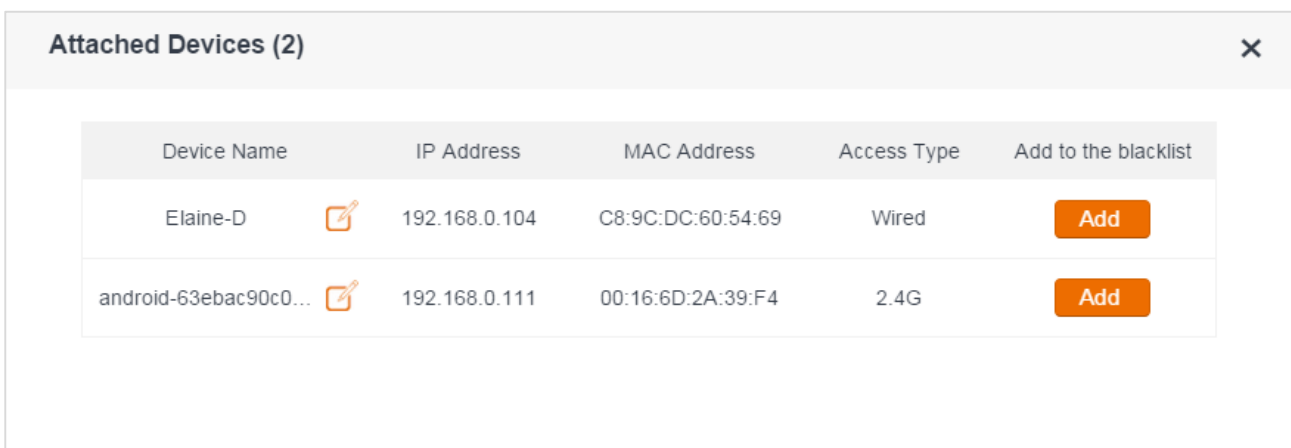
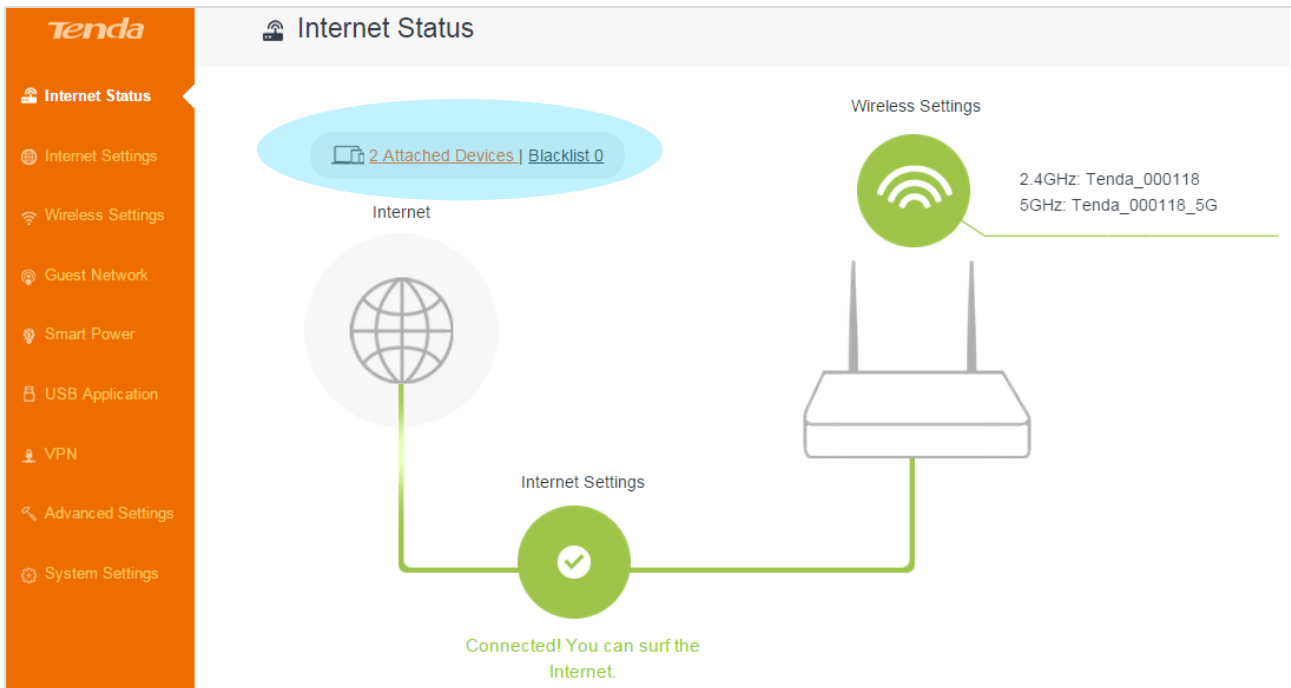

In this page, you can see the connected devices' name, IP address, MAC address, and access type. It allows you to edit the devices' name, and add the unknown devices to blacklist.

Edit the devices' name



Click the icon , input your custom name in the box, and click **Save**.

Attached Devices (2) ✕

Device Name	IP Address	MAC Address	Access Type	Add to the blacklist
Elaine-D 	192.168.0.104	C8:9C:DC:60:54:69	Wired	Add
<input type="text" value=""/> Save	192.168.0.111	00:16:6D:2A:39:F4	2.4G	Add



Attached Devices (2) ✕

Device Name	IP Address	MAC Address	Access Type	Add to the blacklist
Elaine-D 	192.168.0.104	C8:9C:DC:60:54:69	Wired	Add
myellphone 	192.168.0.111	00:16:6D:2A:39:F4	2.4G	Add



Changed Successfully

Add to the blacklist

If you find unknown devices in your network from the **Attached Devices** list, you can add it to blacklist.

Click the corresponding **Add** button on the right, and it will be moved to blacklist.

Attached Devices (2) ✕

Device Name	IP Address	MAC Address	Access Type	Add to the blacklist
Elaine-D 	192.168.0.104	C8:9C:DC:60:54:69	Wired	Add
unknown device 	192.168.0.111	00:16:6D:2A:39:F4	2.4G	Add

Blacklist

The devices in blacklist cannot access the Internet via the Router.

Blacklist(1) ×		
Device Name	MAC Address	Remove from the blacklist
unknown device	00:16:6D:2A:39:F4	Remove

Click **Remove** button to remove the corresponding device back to **Attached Devices** list.

2 Internet Settings

If you don't set up your Internet connection by following Quick Setup Wizard, or want to change your Internet settings, you can refer to this page.

Select your connection type

There are three types of Internet connection on the **Internet Settings** page: DHCP, PPPoE and Static IP. Usually the Quick Setup Wizard will help you to finish Internet settings, and you can also configure them by yourself.

Please refer to [Change the Internet Type](#) for details.

3 Wireless Settings

This section offers some features such as: WiFi Schedule, Wireless Repeating, and Signal Conditioning, which helps you enjoy your WiFi.

Click the following icons (shortcut) to go to the corresponding features.

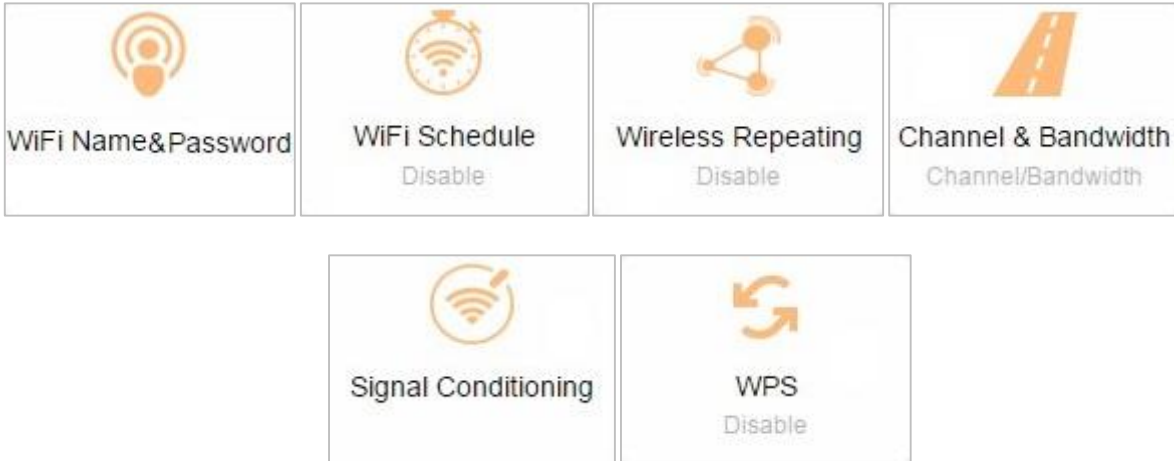

WiFi Name & Password

If you don't customize your WiFi name and password in **Internet Status** page, you can set it up in this part.

Click **Wireless Settings > WiFi Name & Password**.

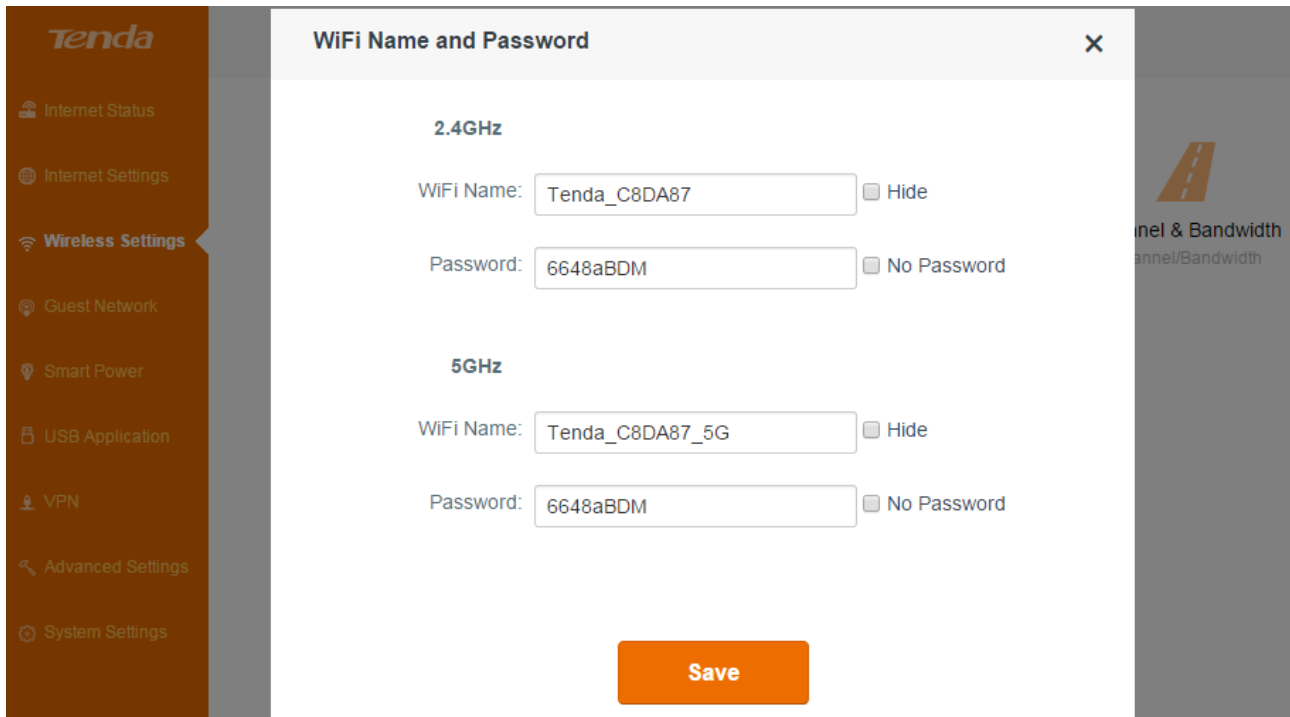

WiFi Name & WiFi Password

The Router provides two types of frequency bands: 2.4GHz and 5GHz. You can assign a unique name

containing up to 32 characters for WiFi name, and customize a password containing up to 63 characters for WiFi password. Note them down if you change the default one avoid forgetting it.

🔽 Hide

If the **Hide** option is checked, the wireless clients cannot search the WiFi name of the Router. You need know the WiFi name in advance and enter the WiFi name on each wireless client manually.

🔽 No Password

If the **No Password** option is checked, there is no password for your WiFi. The wireless device can join in your wireless network by selecting your WiFi name without entering any password. It poses safe risk to your network. So **DO NOT** check this option if unnecessary. But in some case, for example, the Router is used in a small café shop, and you want to share the wireless network with your customers without requiring a WiFi password. Then you can check the **No password** option.

WiFi Schedule

This feature allows you to specify WiFi ON/OFF time. For example, assume that you want to turn off your WiFi during 23:00~06:00, from Monday to Friday, you can configure it as follows:

- 1 Click **WiFi ON/OFF** button to enable the feature.
- 2 Select **23:00** and **06:00** in the **OFF Time** field.
- 3 Select **Specified Day**, and check the options of the corresponding days, **Mon.** to **Fri.**

4 Click **Save**.

Wireless Repeating

The Router can act as a wireless repeater to extend wireless signal. The wireless repeater can have wired and wireless clients, and access the Internet when it connects to the wireless base station. There are two types of Wireless Repeating: **WISP** and **Universal repeater**. When the Router works under **WISP** mode, it assigns IP addresses to its clients by itself. And the clients obtain IP addresses from the base station the Router bridges when the Router works under **Universal repeater** mode. You can select **WISP OR Universal repeater** to extend your wireless network.

You need two routers: one set up as a Router which acts as a base station, and the other set up as a bridge.

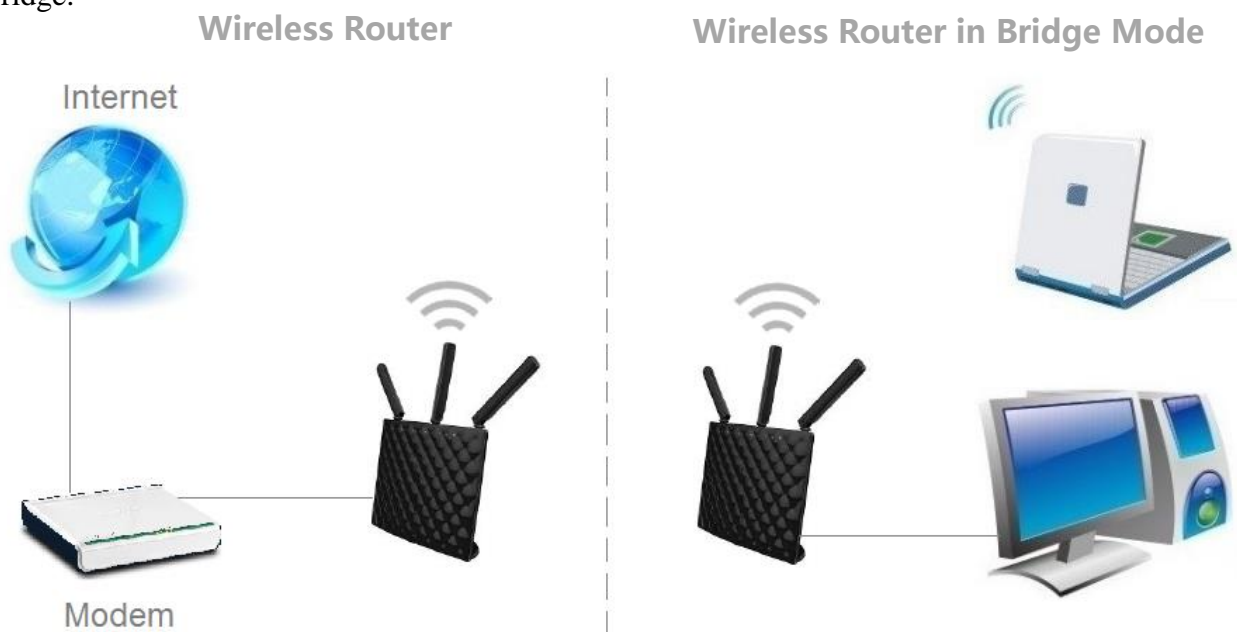

Example

You can install the first Router (Router A) in a room that located on the first floor which has your Internet connection, then set up the second Router (Router B) in bridge modes. And place the Router B in a different room that has your home entertainment center which located on the second floor. Connect the second Router (Router B) in bridge mode to your computer, game console, and etc.

To set up a WISP bridge

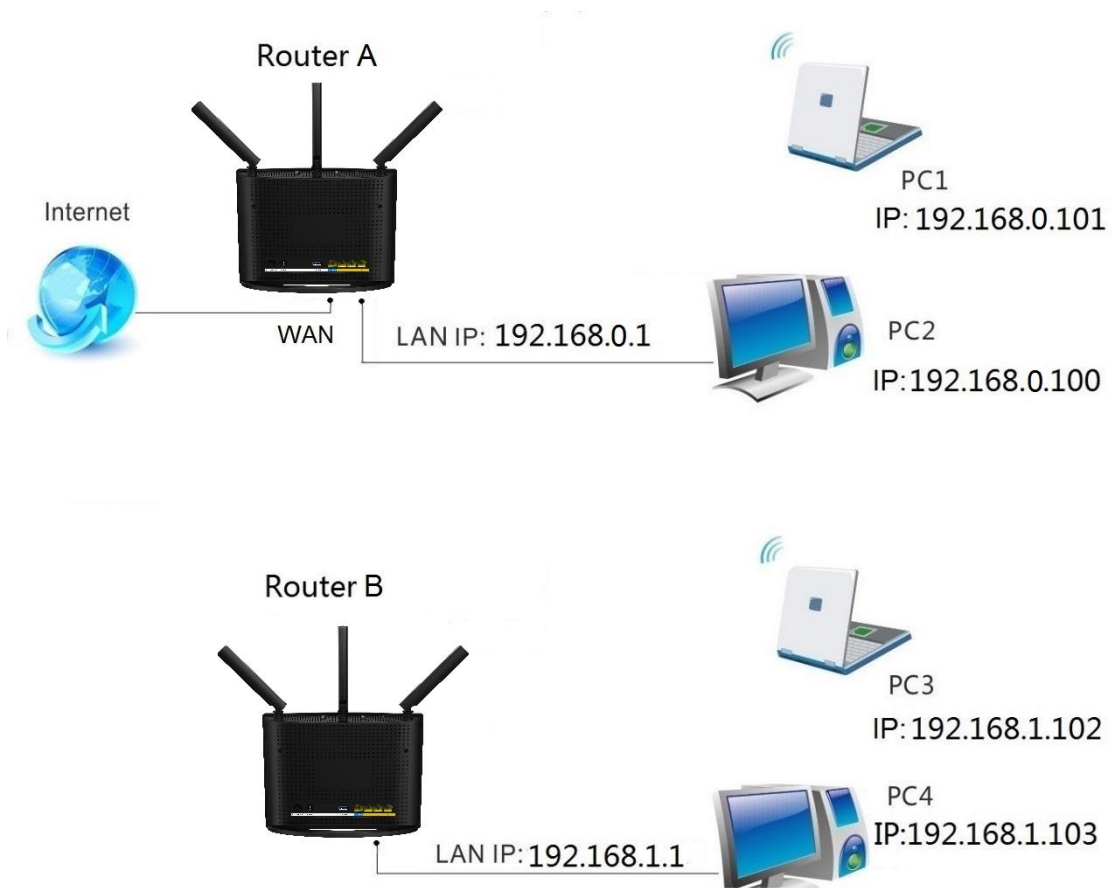

Configure Router B:

Generally, you don't need configure the Router A.

- 1 Make a note of the WiFi name and password of the Router A to which this Router (Router B) will connected.

1	WiFi Name (SSID)	
	WiFi Password	

- 2 Log in to the Router's User Interface, and click **Wireless Settings > Wireless Repeating**. Click the **Wireless Repeating** button to enable the feature.

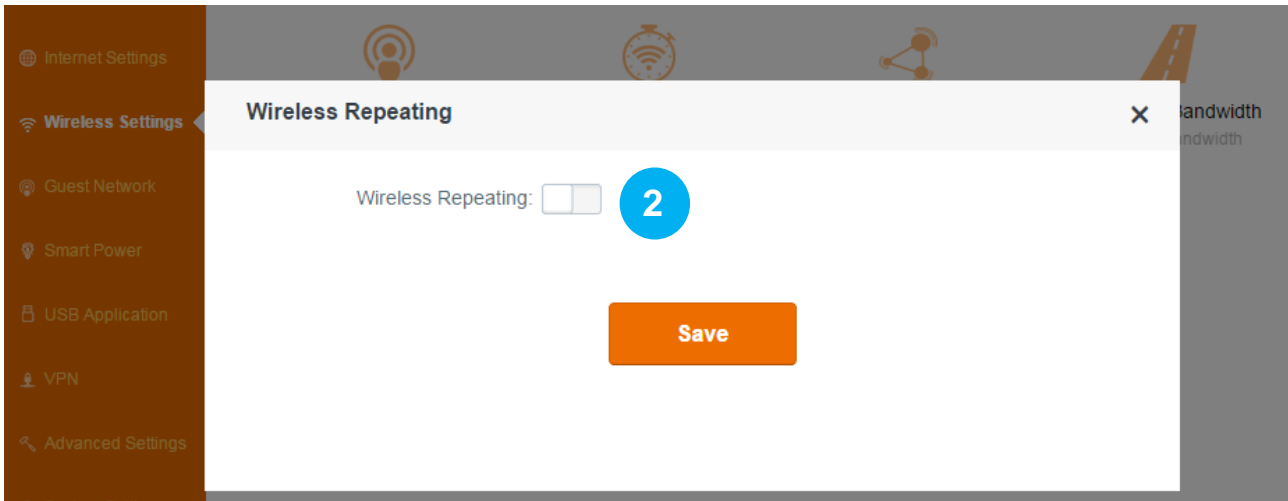

3 Click **Please select**.

4 Find and click the WiFi name (wireless network name) of the base station (Router A).

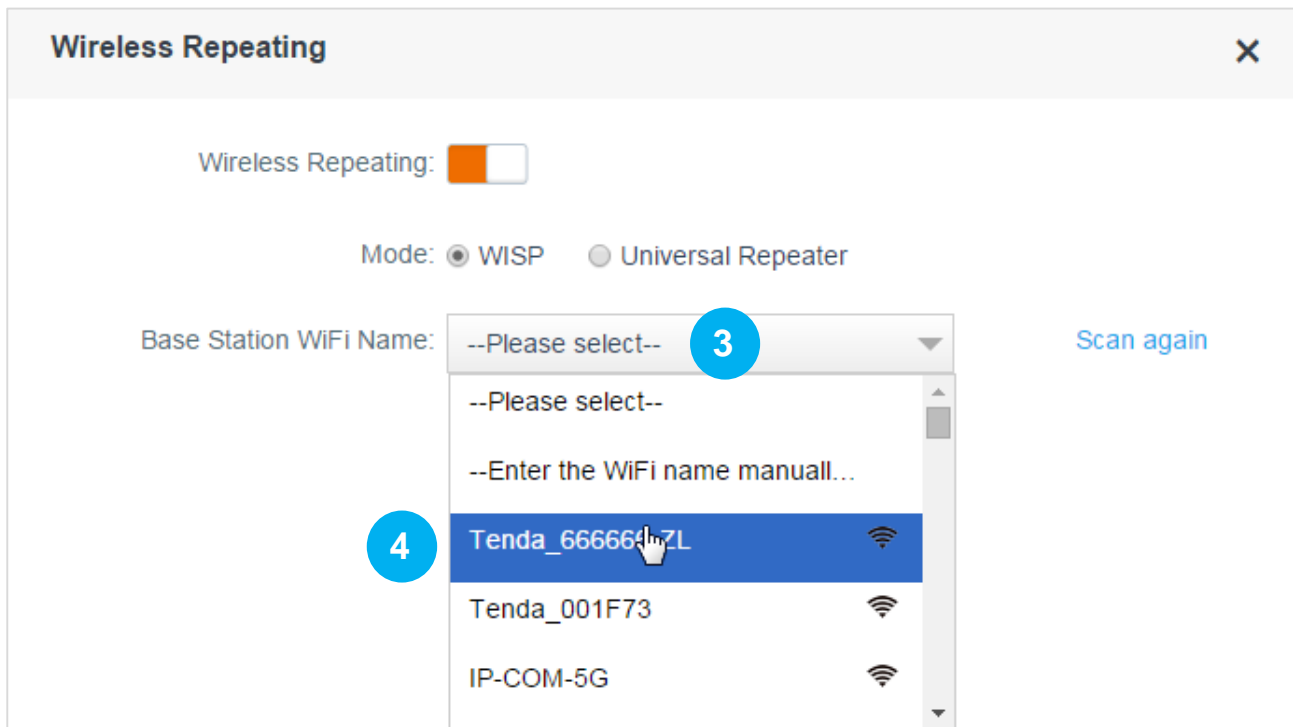

Tips

Router B MUST contain the Router A's channel, or the Router A's WiFi name (wireless network name) won't be displayed in the **Base Station WiFi Name** list. For example, if the Router A's channel is 13, but Router B's channel range is 1~11, you won't find the Router A's WiFi name in the **Base Station WiFi Name** list. So you'd better select the correct country (the country where you use the router), because the **Channel** range varies in different countries. Or you can set the Router A's channel to the one within Router B's channel range.

- 5 Type the security key (WiFi password) of the base station (Router A).
- 6 Click **Save**.

Wireless Repeating:

Mode: WISP Universal Repeater

Base Station WiFi Name: Tenda_666666-ZL [Scan again](#)

Base Station WiFi Password: z1666666

Save

- 7 Click **OK** on the prompt window.

The page at tendawifi.com says:

WPS feature will be disabled if the Wireless Repeating is enabled. Are you sure to save it?

7 **OK** Cancel

Check whether the bridge is successful

After this Router (Router B) auto-reboots, log in to this Router's (Router B's) User Interface, and click **Internet Status**. Check the connection status. If it displays **Connected! You can surf the Internet**, it indicates that the bridge is successful.

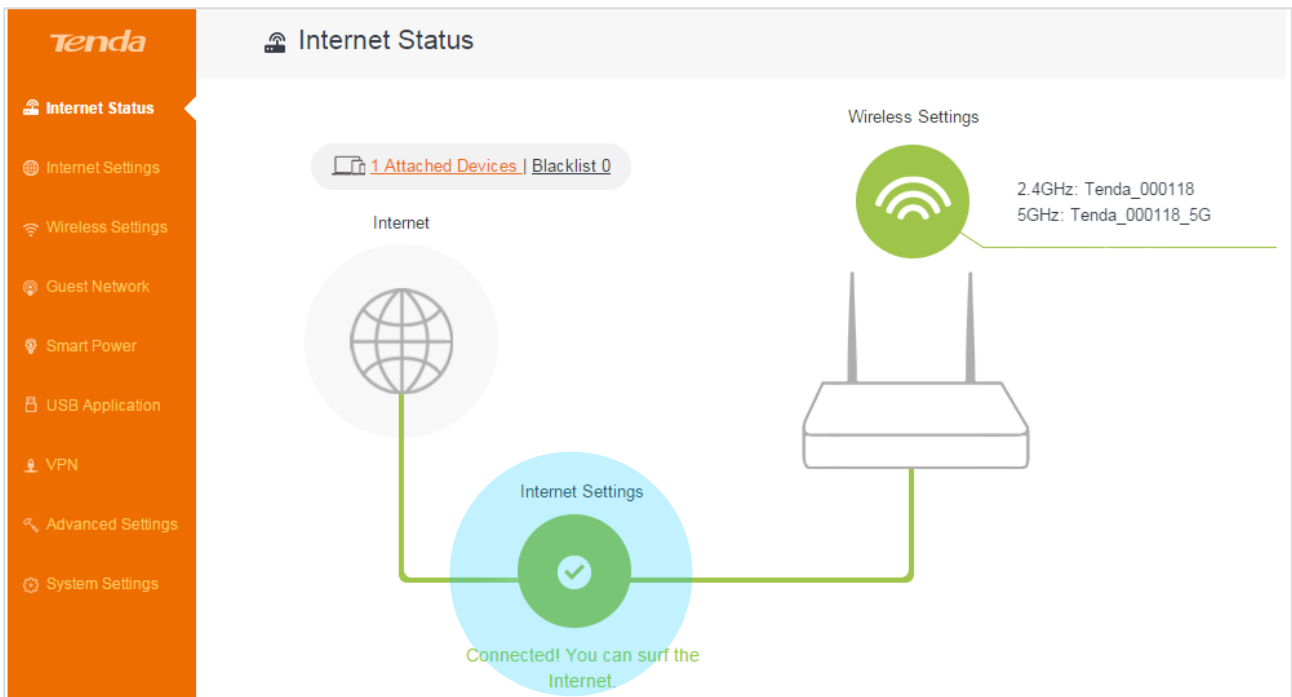

If the bridge failed, try solving the problem as follows:

Verify that the Router A's DHCP server is enabled. If not,

- Enable the Router A's DHCP sever.
- Or click **Internet Settings**, select **Static IP**, type the required info in the corresponding field, and click **OK**.

Note

1. The WiFi Schedule, WPS, Guest Network, Smart Power-save, and IPTV feature are not available when the Router B is in WISP mode.
2. The configuration of the Router b's wireless channel won't take effect after bridge.
3. If Router B's LAN IP address is the same as that of Router A, it will be changed into another one automatically which is not in the same network segment as that of Router A after bridge. For example, if the Router A and Router B's LAN IP address are all 192.168.0.1, the Router B's LAN IP address will be changed into 192.168.1.1 after bridge. You can use 192.168.1.1 or the domain name tendawifi.com to log in to the Router B's User Interface.

To set up a Universal Repeater bridge

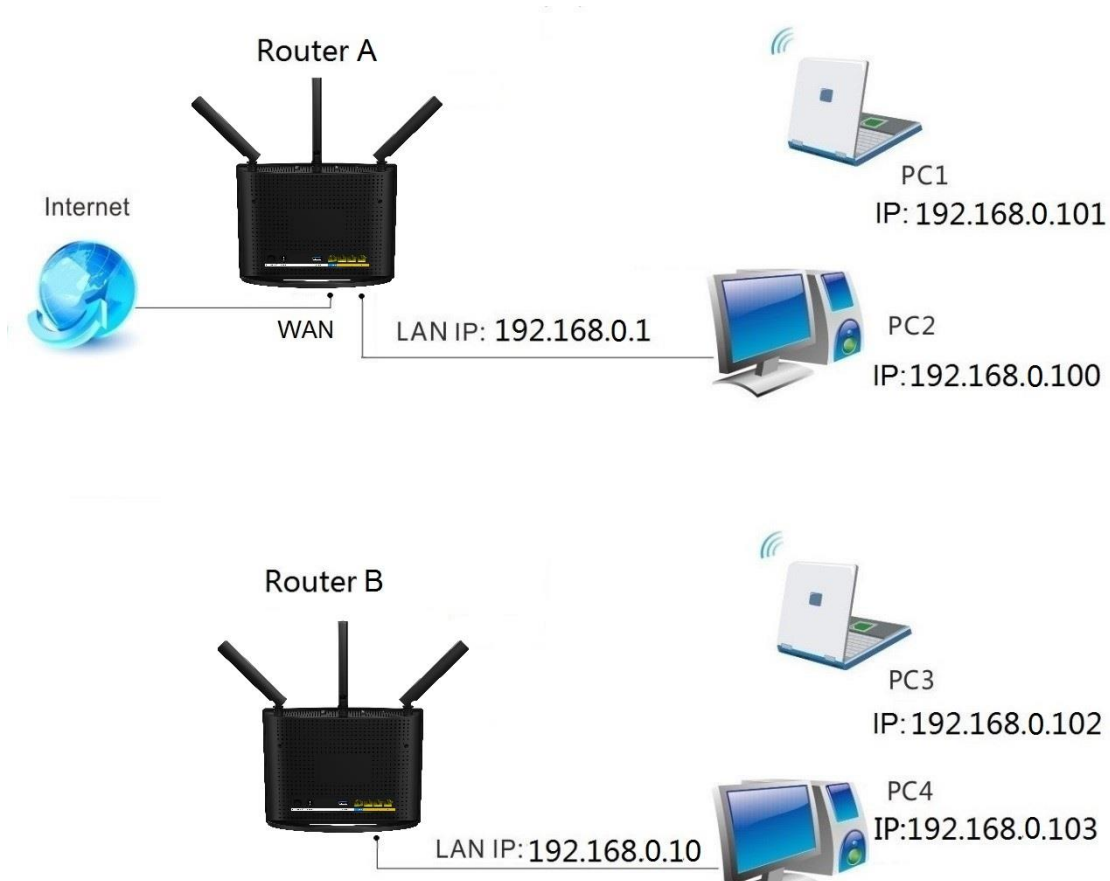

Configure Router B:

Generally, you don't need configure the Router A.

Note

The DHCP of Router A MUST be enabled.

- 1 Make a note of the WiFi name and password of the Router A to which this Router (Router B) will connected.

1	WiFi Name (SSID)	
	WiFi Password	

- 2 Log in to the Router's User Interface, and click **Wireless Settings > Wireless Repeating**. Click the **Wireless Repeating** button to enable the feature.

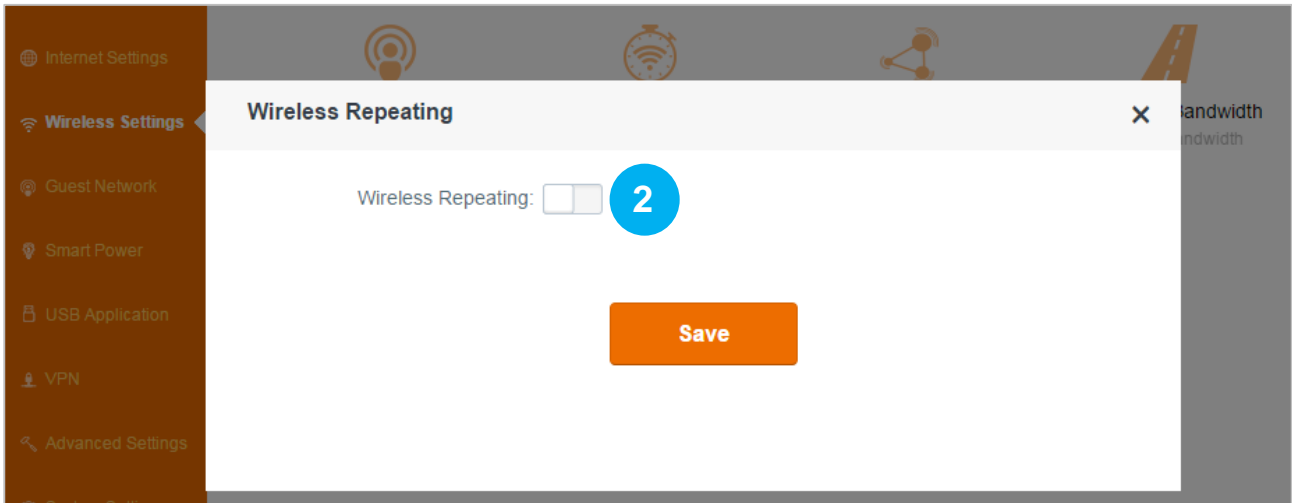

- 3 Select **Universal Repeater**.
- 4 Click **Please select**.
- 5 Find and click the WiFi name (wireless network name) of the base station (Router A).

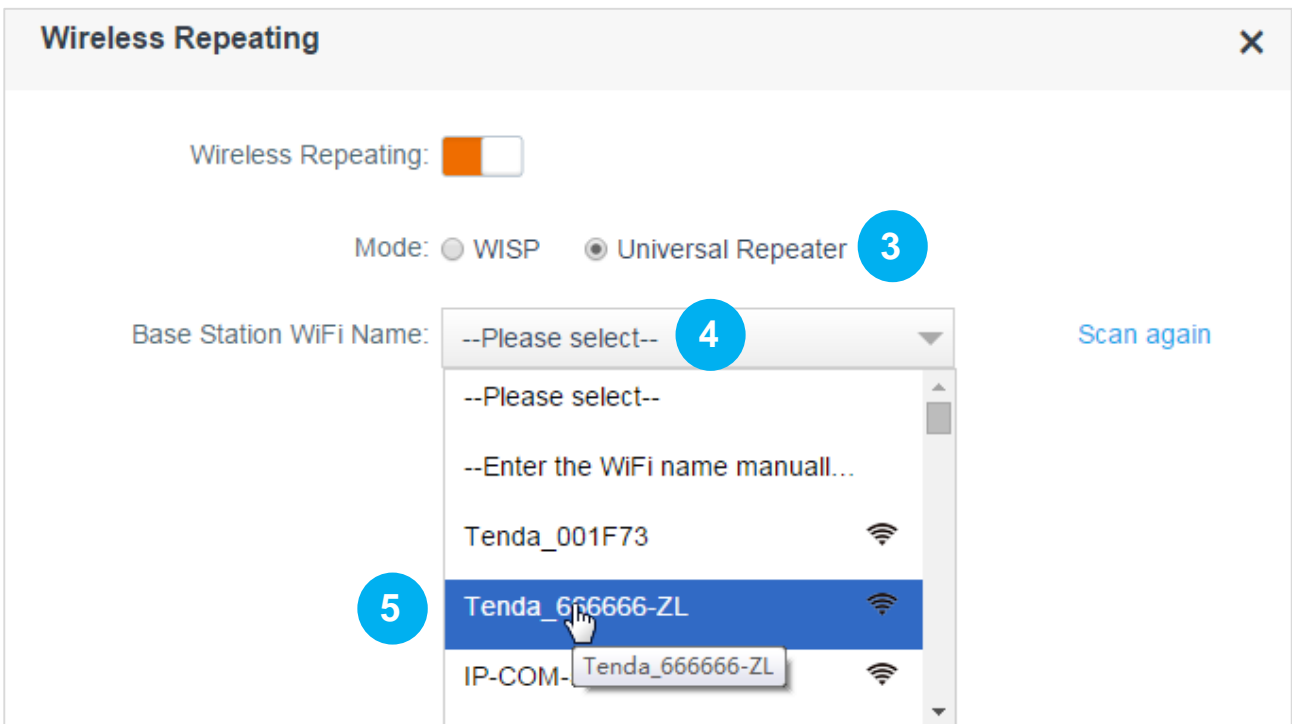



Tips

Router B MUST contain the Router A's channel, or the Router A's WiFi name (wireless network name) won't be displayed in the **Base Station WiFi Name** list. For example, if the Router A's channel is 13, but Router B's channel range is 1~11, you won't find the Router A's WiFi name in the **Base Station WiFi Name** list. So you'd better select the correct country (the country where you use the router), because the **Channel** range varies in different countries. Or you can set the Router A's channel to the one within Router B's channel range.

6 Type the security key (WiFi password) of the base station.

7 Click **Save**.

Wireless Repeating
✕

Wireless Repeating:

Mode: WISP Universal Repeater

Base Station WiFi Name: Scan again

Base Station WiFi Password: 6

7

8 Click **OK** on the prompt windows.

The page at tendawifi.com says:
✕

The router will reboot automatically to activate your settings. Are you sure to reboot the router?

8

Check whether the bridge is successful

After this Router (Router B) auto-reboots, log in to this Router's (Router B's) User Interface, and

click **Internet Status**. Check the connection status. If it displays **Bridged successfully in Universal Repeater mode**, it indicates that the bridge is successful.

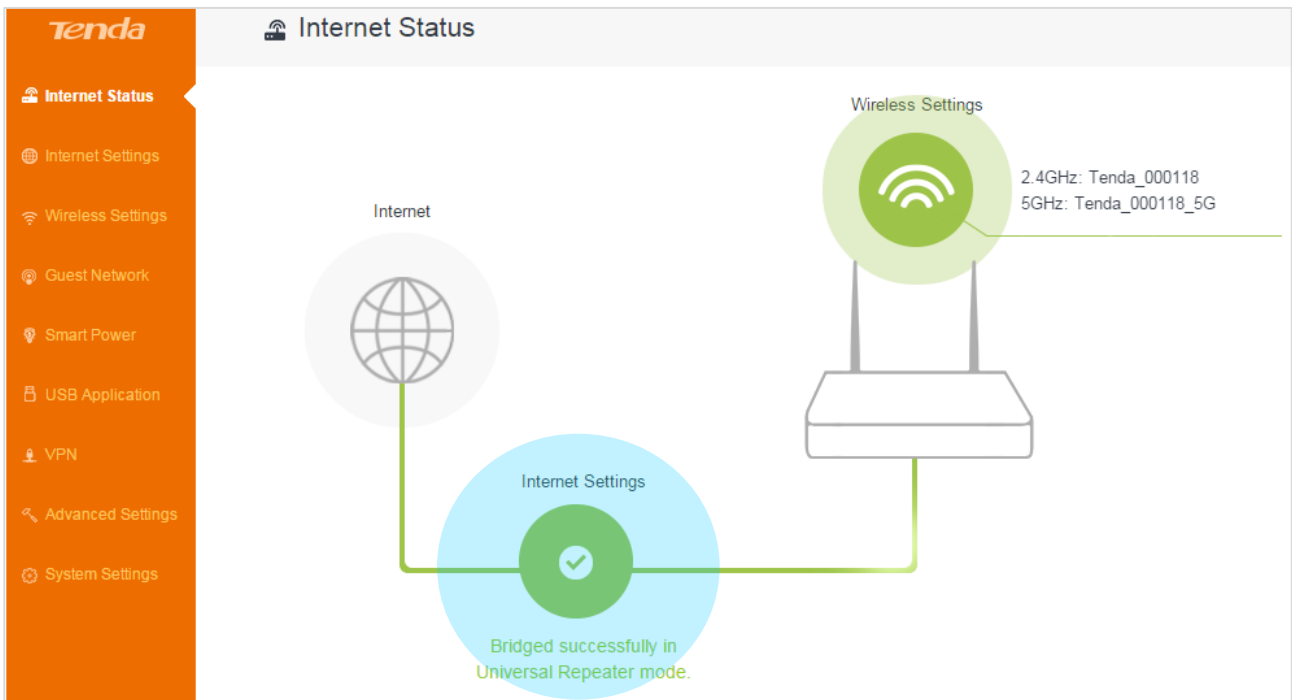

Note

1. You can only use the Router B's domain name **tendawifi.om** to log in to the Router B's User Interface after bridge.
2. The Internet Setting, LAN IP Settings, WAN IP Settings, Parental Control, Bandwidth Control, Remote WEB, DDNS, Virtual Server, UPnP, IPTV, Smart Power-save, Guest Network, WPS, and WiFi Schedule feature are not available when the Router B is in Universal Repeater mode.
3. The configuration of Router B's channel won't take effect after bridge.
4. You cannot manage the attached device when the Router is in Universal Repeater mode.

Channel & Bandwidth

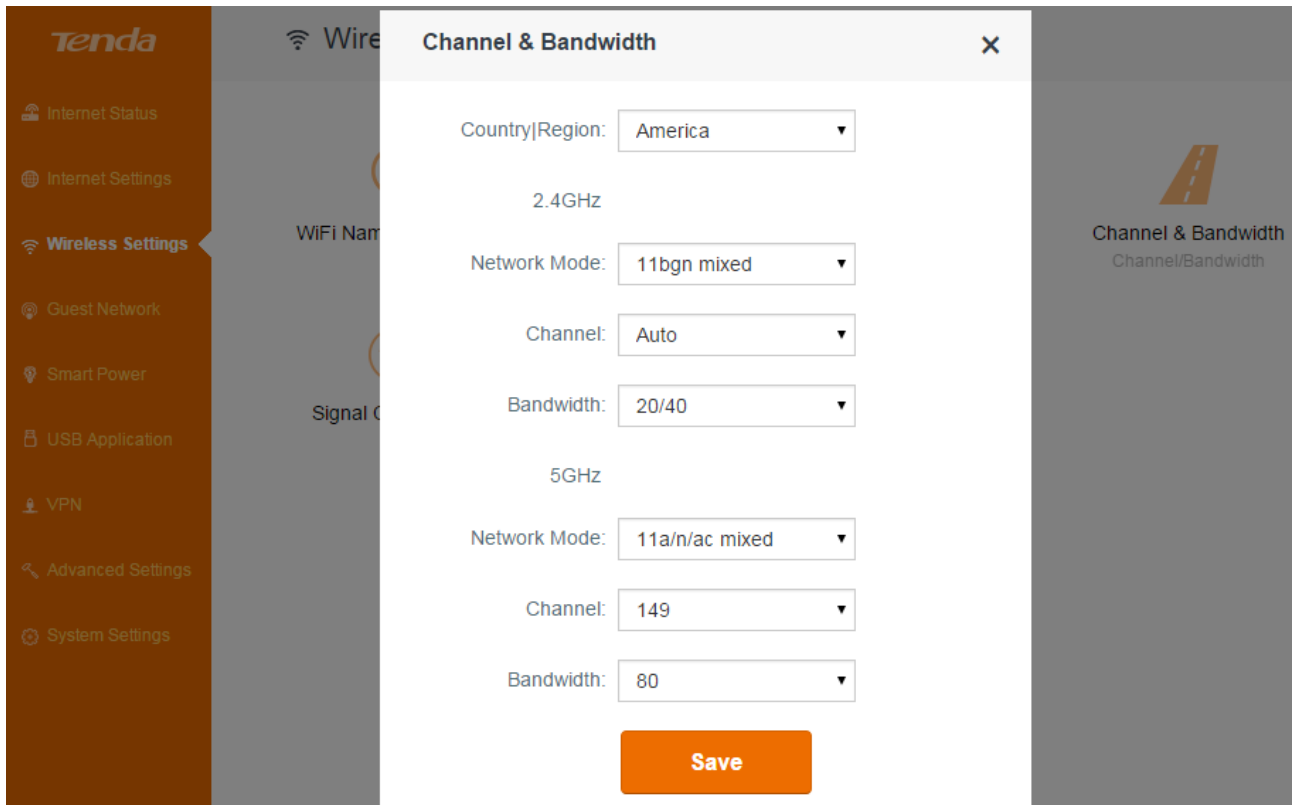

In this part, you can change the basic settings of your wireless network. There are two different frequency bands: 2.4GHz and 5GHz.

1. In the **Country|Region** list, select your region.
2. This Router supports 3 network modes for 2.4GHz frequency band, and 2 modes for 5GHz frequency band. To change the mode, select it from the **Network Mode** list. The default one is optimum.

For 2.4GHz

Mode	Compatibility	Wireless Speed
11bgn mixed	Allows 802.11b, 802.11g, and 802.11n devices to join the network.	Up to 600Mbps
11bg mixed	Allows 802.11b and 802.11g devices to join the network.	Up to 54Mbps
11n only	Allows 802.11n devices to join the network.	Up to 54Mbps

For 5GHz

Mode	Compatibility	Wireless Speed
11a/n/ac mixed	Allows 802.11a, 802.11n, and 802.11ac devices to join the network.	Up to 1300Mbps
11ac only	Allows 802.11a and 802.11c devices to join the network.	Up to 1300Mbps

3. In different regions, the **Channel** range varies. To change the wireless channel, select a number from the **Channel** list. Do not change the channel unless you experience interference (shown by lost wireless connection or slow data transfers). If this happens, experiment with different channels to see which the best is. The recommended channel spacing between adjacent access points is four channels (for example, use channel 1 and 5, or 6 and 10).

4. Select any of these channel bandwidths to accommodate higher transmission speeds:

- **40** (default): Select this bandwidth to maximize the wireless throughput. Keep the default unless you encounter some issues with your wireless connection.
- **20**: Select this bandwidth if you encounter some issues with your wireless connection.

When the 2.4GHz network mode is set to **11bg mixed**, the 2.4GHz bandwidth can only be **20**.

For 2.4GHz

- **20/40**: Select this bandwidth to switch among **20** and **40** according to the situation of the current wireless network.

For 5GHz

- **80** (default): Select this bandwidth to maximize the wireless throughput. Keep the default unless you encounter some issues with your wireless connection.
- **20/40/80**: Select this bandwidth to switch among **20**, **40** and **80** according to the situation of the current wireless network.

Signal Conditioning

There are three levels of signal strength for 2.4GHz and 5GHz frequency bands: low, medium, and high (default). Select **Low** if it can satisfy you. **Standard** offers the widest coverage range while **High** has strong capability of penetrating wall. Select one from them according to your needs.

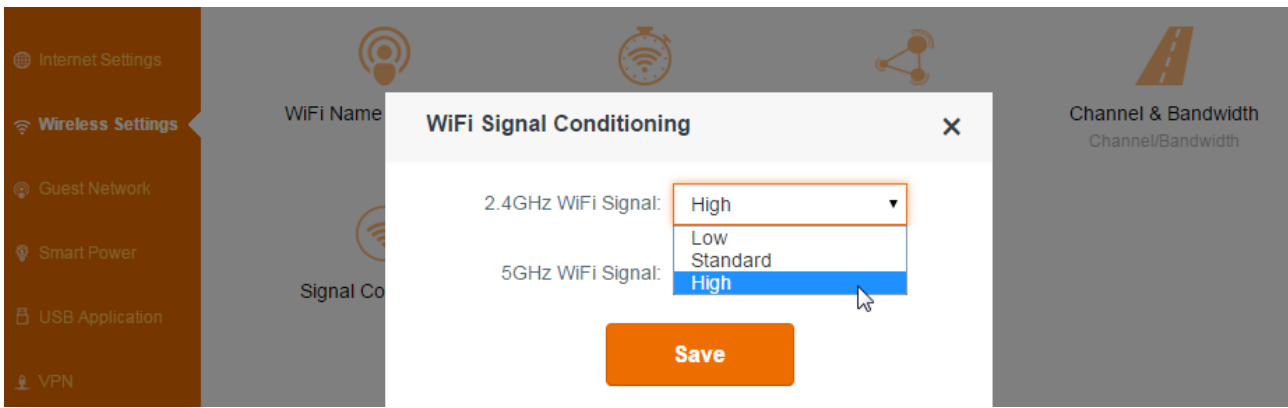

WPS

WPS (Wi-Fi Protected Setup) allows you to join the WiFi network without typing the WiFi password. You can establish a WPS connection to your wireless Router via WPS button, or PIN code.

To establish a WPS connection:

Log in to the Router's User Interface, and click **Wireless Settings** > **WPS**, and click to enable the WPS feature.

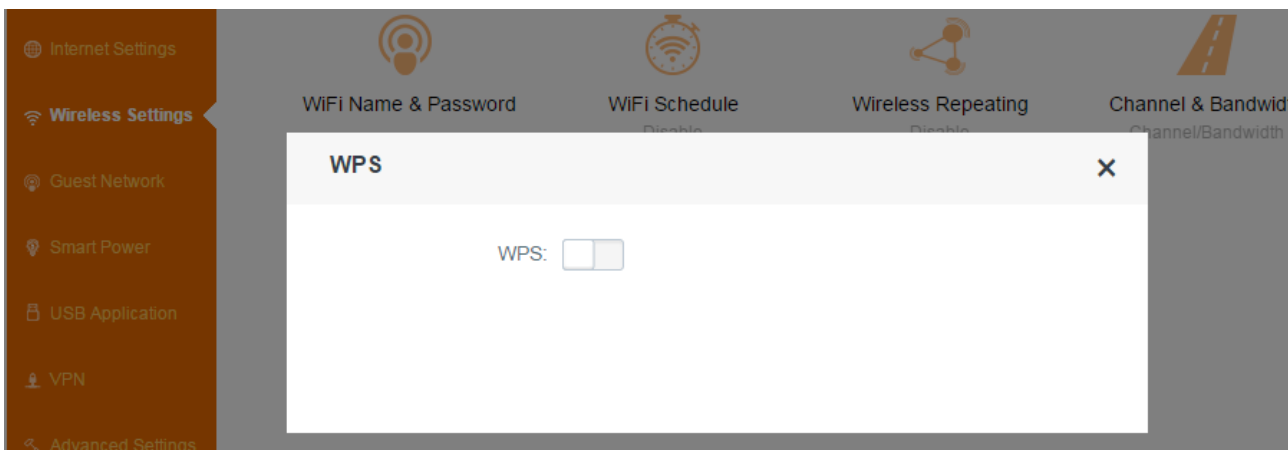

Use a WPS button

If your wireless client has a WPS push button, you can use it to connect to the Router.

- 1 Press and hold the **WPS** button for about half a second on the Router and then release it, or click the **WPS** button on the Webpage.

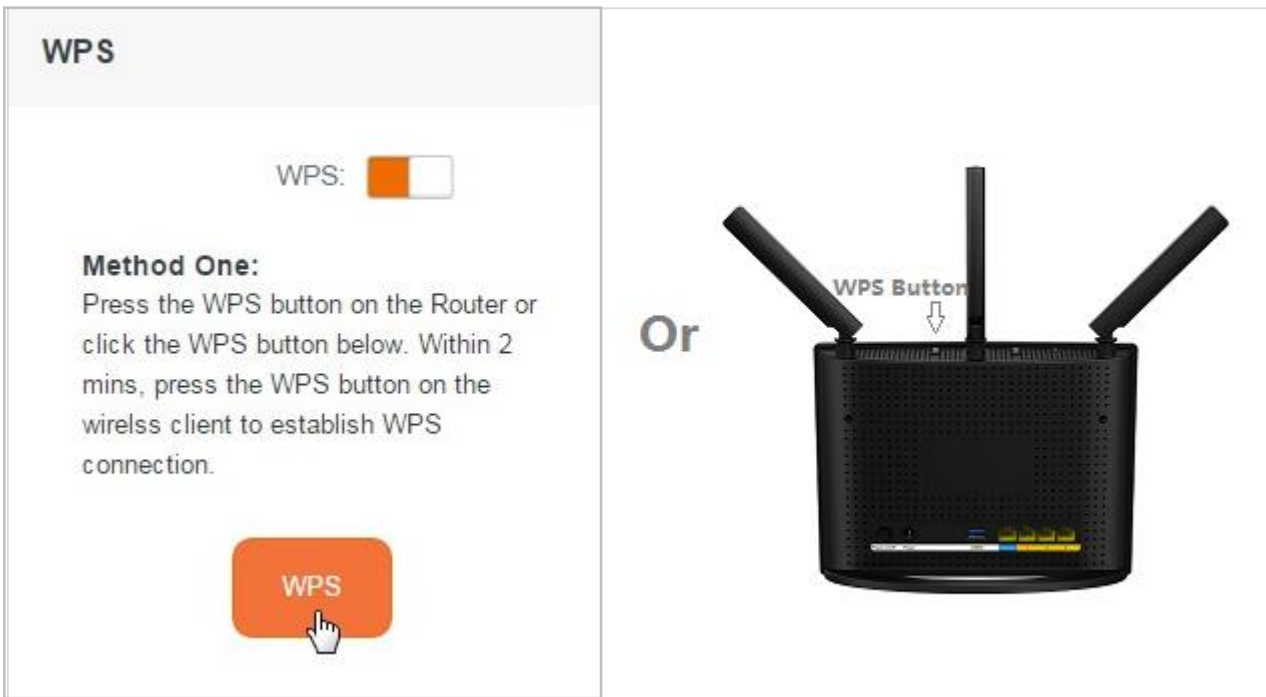

② Within 2 minutes, enable WPS feature on your wireless clients.

Take SAMSUNG cellphone as an example:

Enter the **WLAN** setting page, and tap the icon  on the bottom left corner on the cellphone.

Then select **WPS push button** on the pop-up subpage. The cellphone's WPS feature is enabled.

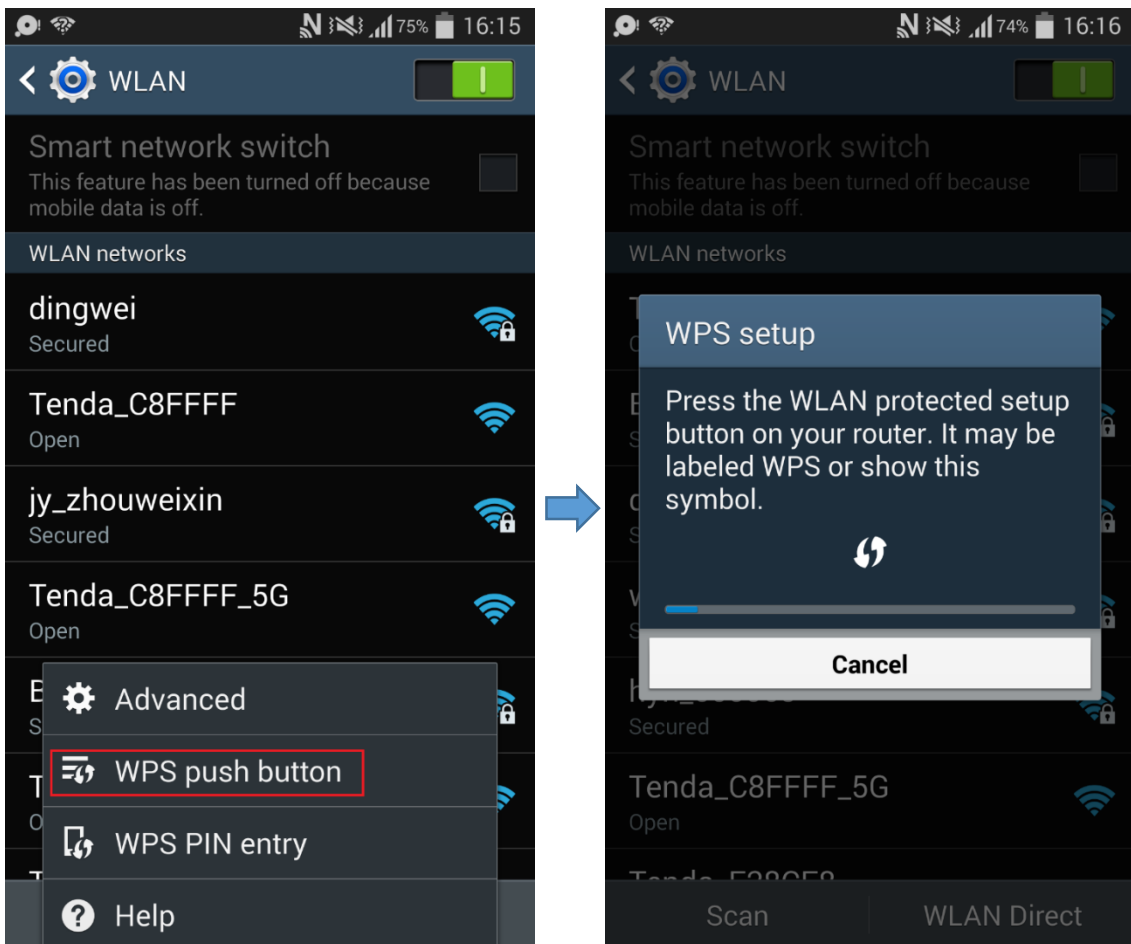

Use a PIN code

If your wireless client requires a PIN code, enter the PIN code on the page into the required box.

Method Two:

Enter the PIN code below on the wireless client to establish WPS connection.

PIN code:84844088



Tips

The WiFi password will be changed into a random password with 63 characters if you use the PIN code to establish a WPS connection.

4 Guest Network

A guest network allows visitors at your home to use a separate SSIDs or networks without providing access to your private network. You can create a guest network for each wireless network: 2.4GHz and 5GHz.

To create a guest network:

Log in to the Router's User Interface, and click **Guest Network**.

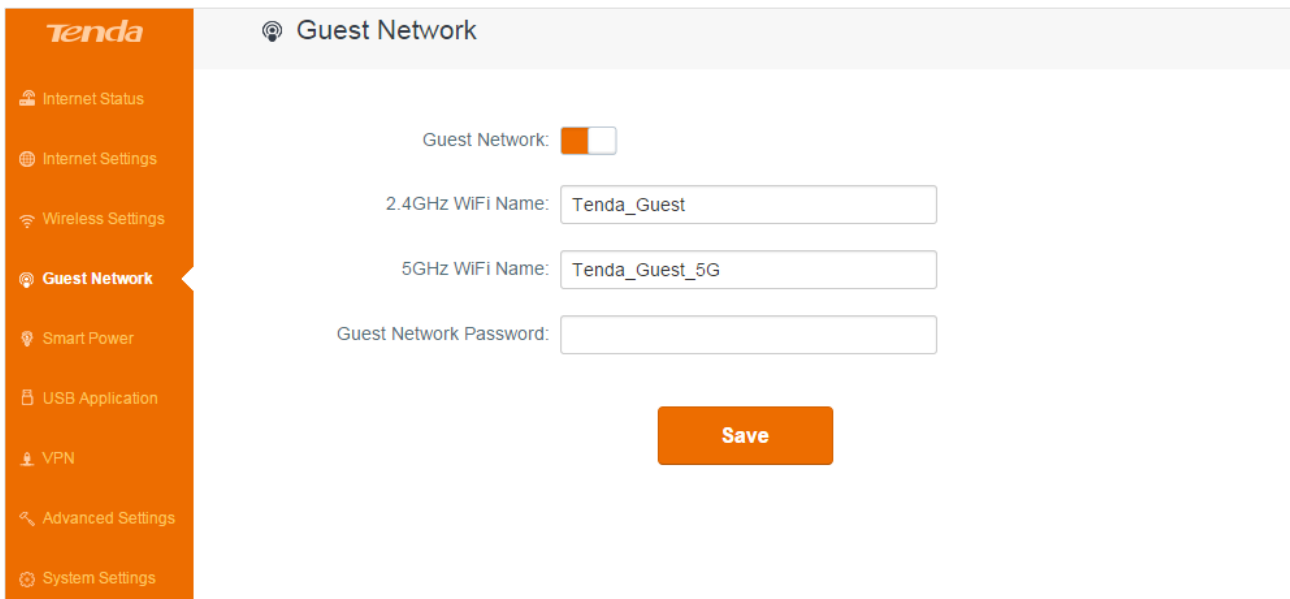

The screenshot shows the Tenda Router's User Interface (UI) for configuring the Guest Network. The left sidebar contains a navigation menu with the following items: Internet Status, Internet Settings, Wireless Settings, **Guest Network** (highlighted), Smart Power, USB Application, VPN, Advanced Settings, and System Settings. The main content area is titled "Guest Network" and features a toggle switch for "Guest Network" which is currently turned on. Below the toggle are three input fields: "2.4GHz WiFi Name" with the value "Tenda_Guest", "5GHz WiFi Name" with the value "Tenda_Guest_5G", and "Guest Network Password" which is empty. A prominent orange "Save" button is located at the bottom center of the configuration area.

1. Click **Guest Network** button to enable the feature.
2. Customize a WiFi Name for 2.4GHz and 5GHz network respectively and a password for both of them.
3. Click **Save**.

5 Power Saving

Smart power-save allows you to schedule your Router's working time.

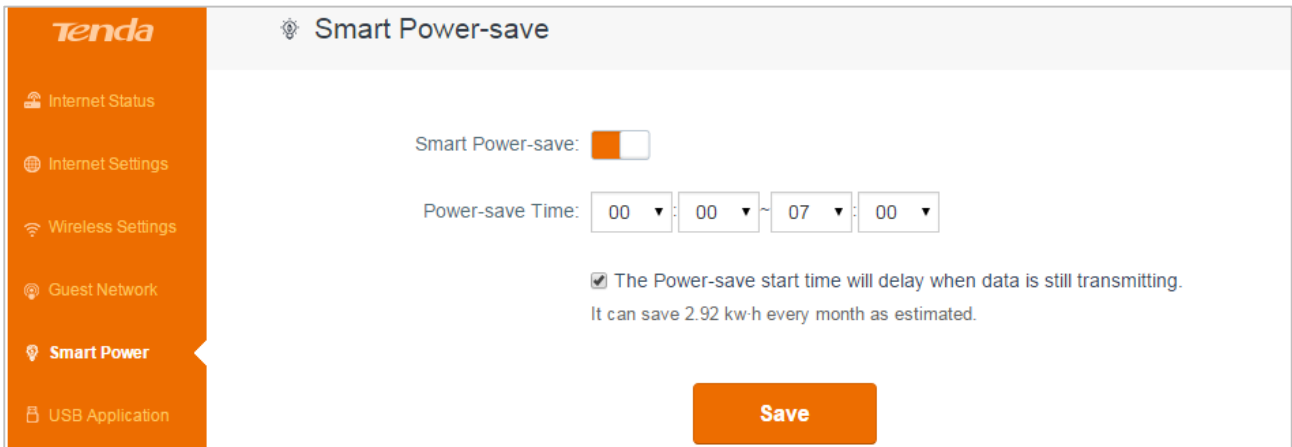

To schedule the Router's working time:

Log in to the Router's User Interface, and click **Smart Power**.

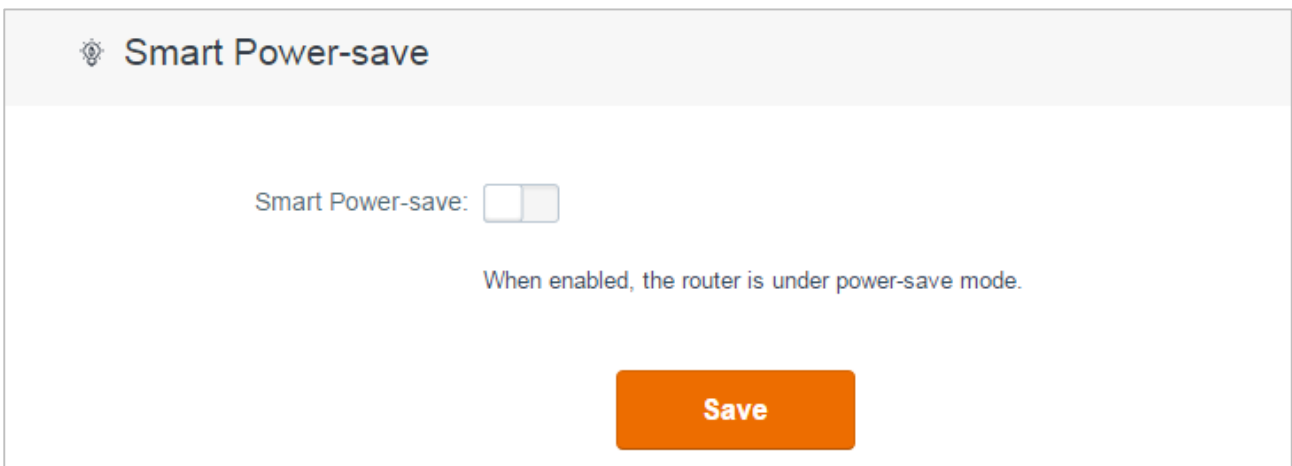

Smart Power-save

Smart Power-save:

Power-save Time: 00 : 00 ~ 06 : 00

The Power-save start time will delay when data is still transmitting.
It can save 2.50 kw-h every month as estimated.

Save

1. Click **Smart Power-save** button to enable the feature.
2. Select the Power-save time during which the Router will be in power-save mode.
3. Check or uncheck the option according to your needs. When the option is checked, the Router will keep working unless the NAT data transmitting speed is less than 3KB/s for 30 minutes.
4. Click **Save**.

6 USB Application

The USB application provides **File Share**, **DLNA**, and **Printer Service** submenus. Click the following icons to skip to the corresponding features.



File Share

The Router allows you to share files on a connected USB device from the local clients, or devices from the Internet.

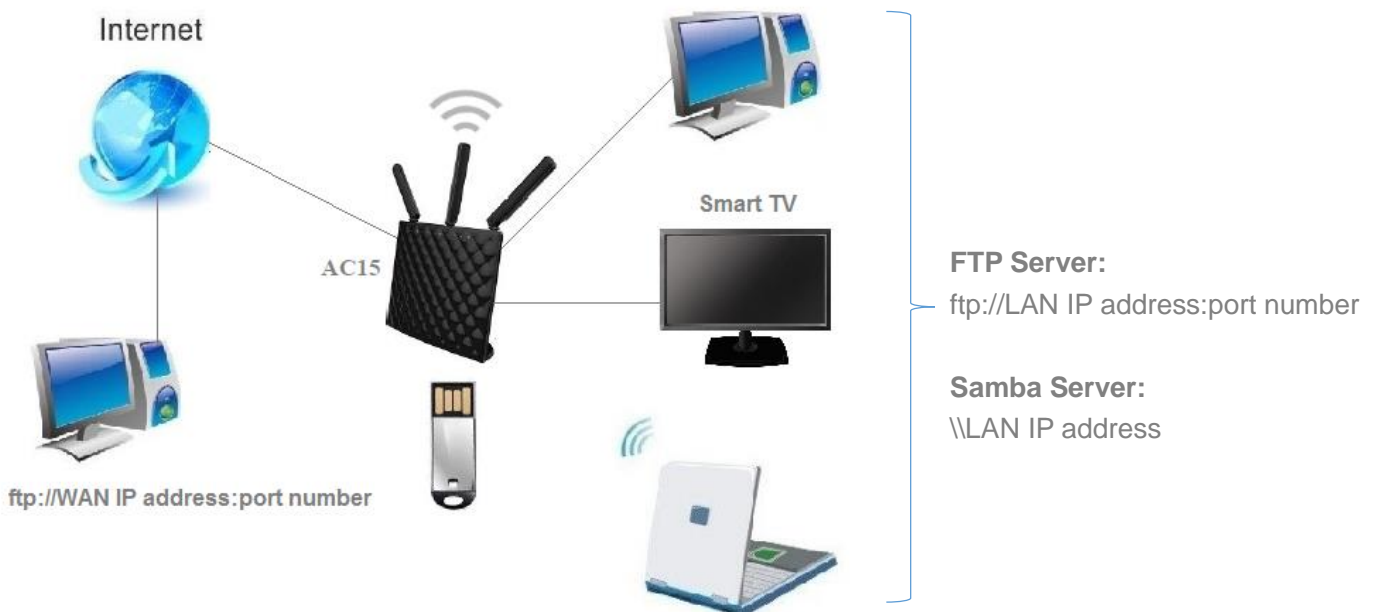

➤ To connect a USB drive

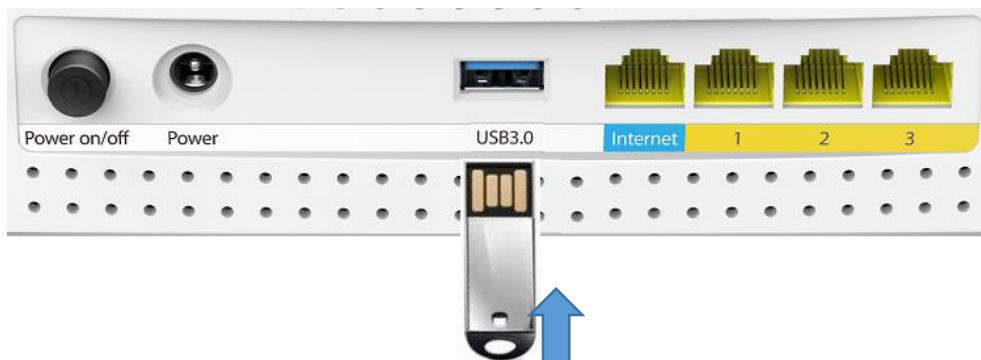

Insert your USB storage drive into the USB3.0 port on the back panel of the Router.

⚠ Note

1. DO NOT remove the USB drive when it is working to avoid data loss or other damages.
2. DO NOT concurrently connect two or more external hard drives to the router's USB3.0 port with the help of a USB hub to avoid possible damages to the router.

To access the USB drive

Log in to the Router's User Interface, and click **USB Application > File Share**.

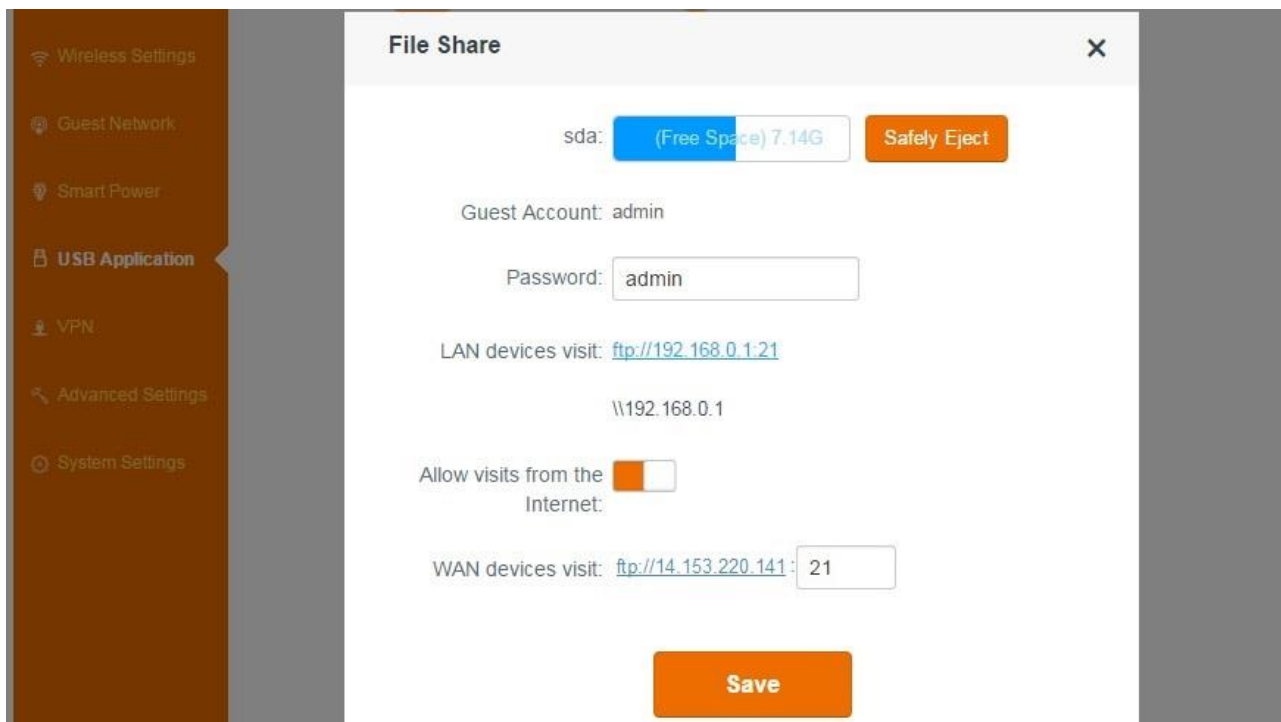

Page Info

<p>sda</p>	<p>When a USB storage drive is attached, the Router will detect it automatically and this place will display the free space of it. Click Safely Eject button on the right after use.</p>
<p>Guest Account & Password</p>	<p>The File Share includes FTP server and Samba Server. Both of the servers use the same account and password. The default account is admin which isn't editable. But you can specify a password to access the servers.</p>
<p>LAN devices visit</p>	<p>The addresses displayed here will be changed with the LAN address. On LAN computer, visit the FTP server using ftp://xxx.xxx.xxx.xxx:xx; visit the Samba server using \\xxx.xxx.xxx.xxx.</p>
<p>WAN devices visit</p>	<p>The address displayed here will be changed with the WAN address. On WAN computer, visit the FTP server using the address displayed here.</p>

Allow visit from the Internet	If you want to allow the devices from the Internet to visit your USB storage drive, you need enable this button.
--------------------------------------	--

To access the USB storage drive (FTP server) from your LAN computer:

1. Type the address ftp://xxx.xxx.xxx.xxx:xx (ftp://192.168.0.1:21 here) in the address bar of a web browser. Tap **Enter** on the keyboard.

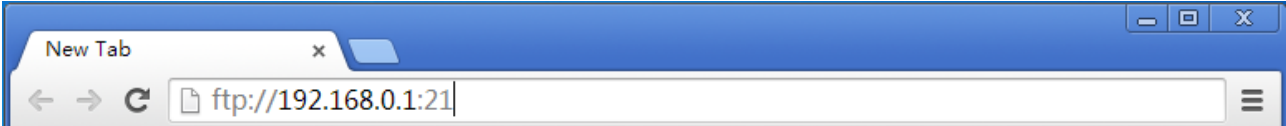

2. Type the default User name (Guest account) and the Password you just specified and click **Log In**.

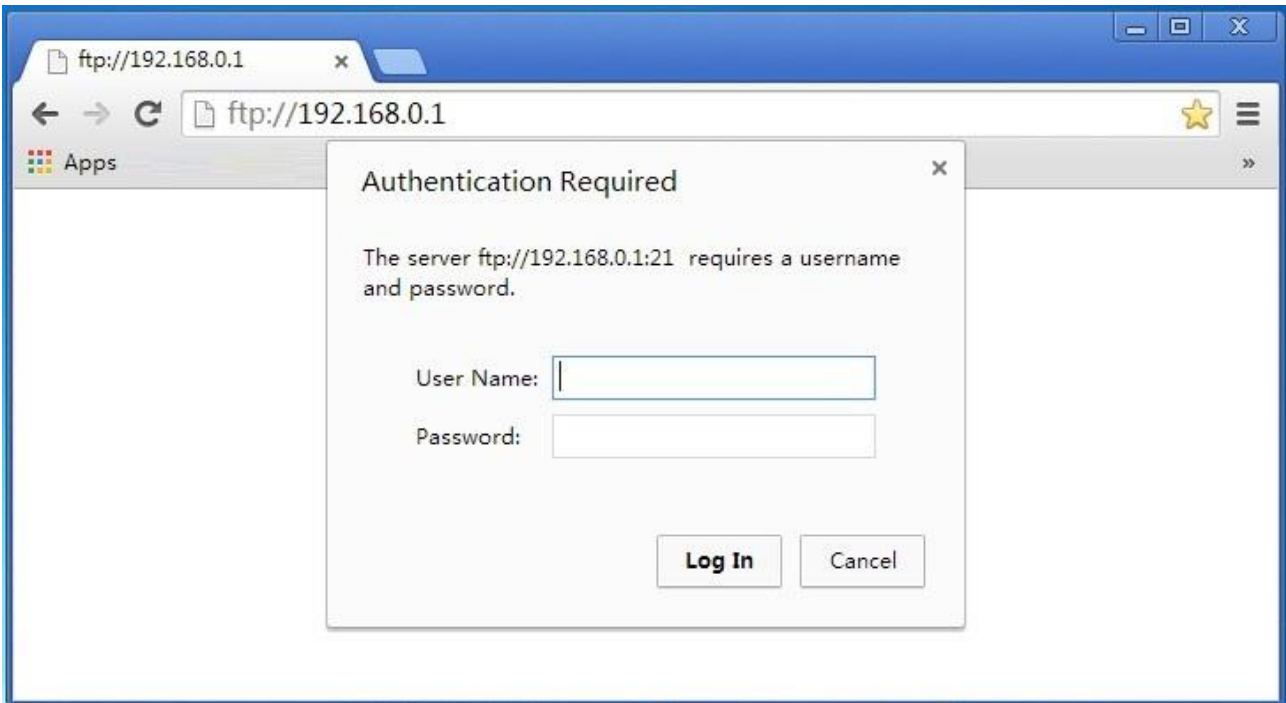

Then you can share the files on the USB storage drive.

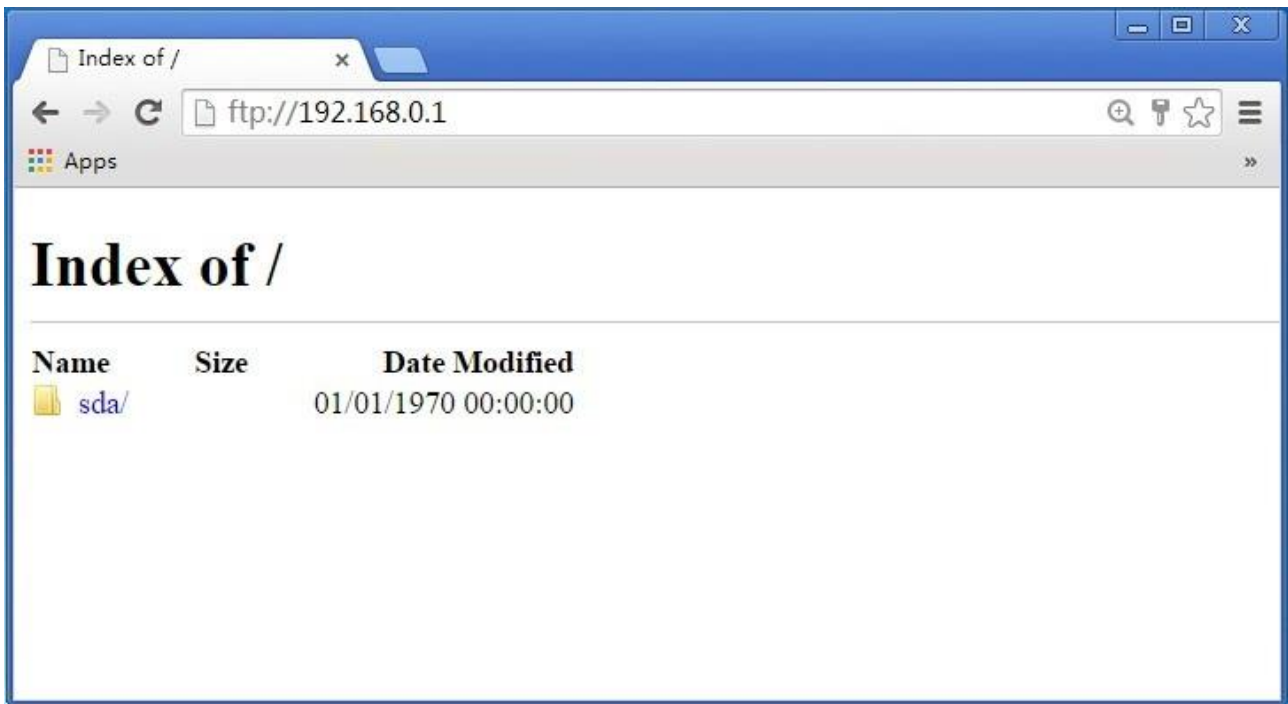

To access the USB storage drive (FTP server) from WAN computer:

Configure your Router:

To allow the devices from the Internet to visit your USB storage drive, you need verify that the **Allow visit from the Internet** button is enabled.

1. Log in to the Router's User Interface, and click **USB Application > File Share**.

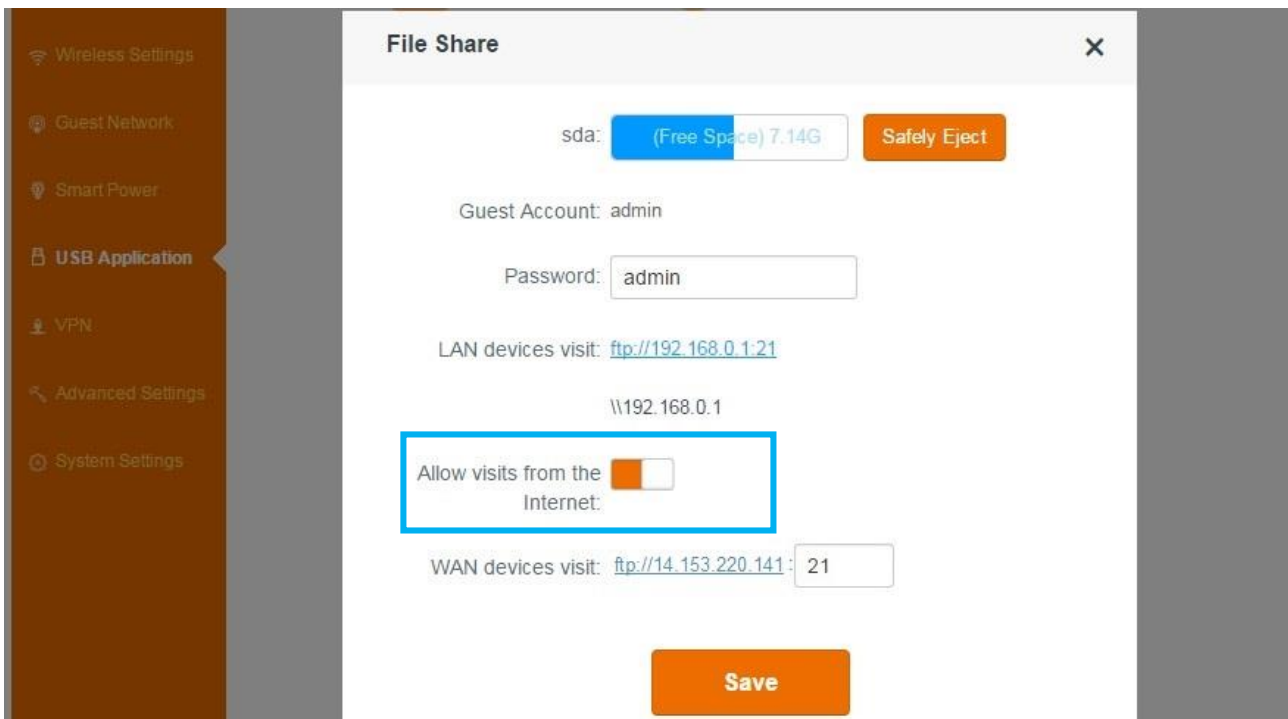

2. Click **Allow visit from the Internet** button.

3. Click **Save**.

Visit the USB storage drive (FTP server) from the Internet:

1. Type the address ftp://xxx.xxx.xxx.xxx:xx (xxx.xxx.xxx.xxx MUST be public IP address, ftp://14.153.220.141:21 here) in the address bar of a web browser on a computer from the Internet. Tap **Enter** on the keyboard.

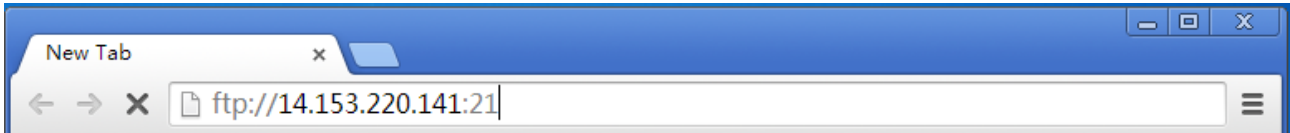

2. Type the default User name (Guest account) and the Password you just specified and click **Log In**.

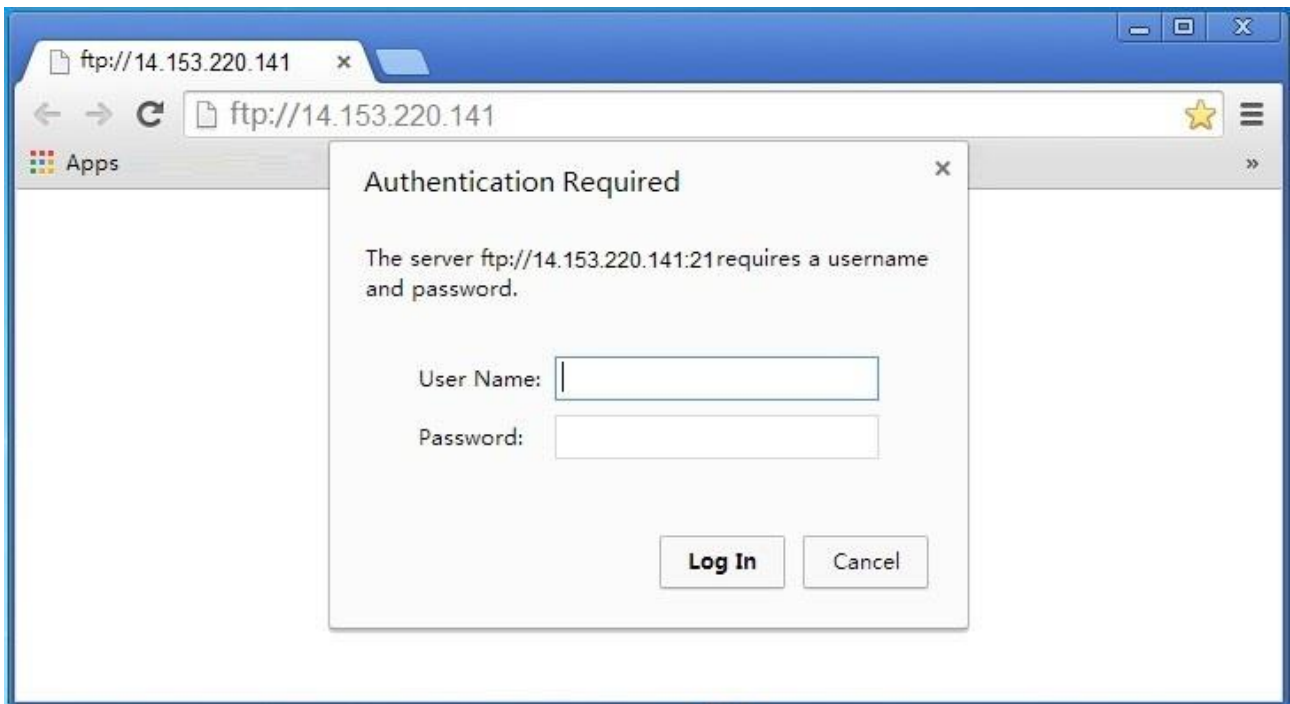

Then you can share the files on the USB storage drive.

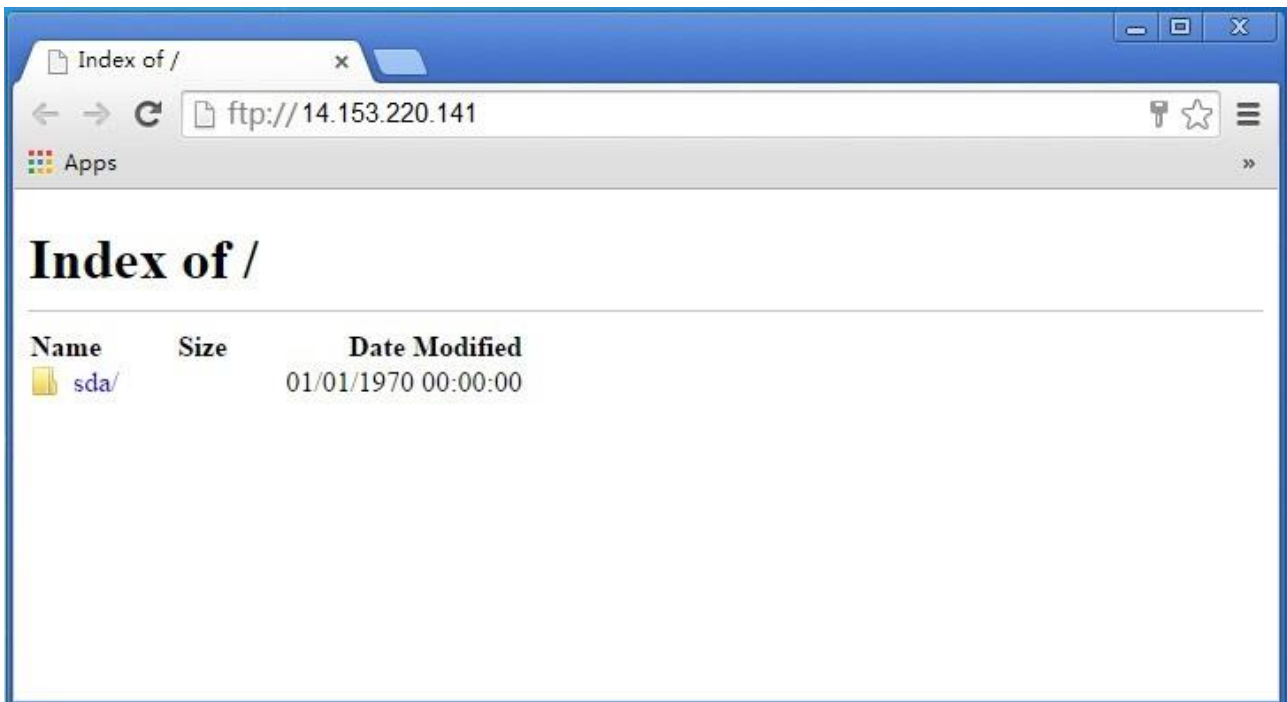

To access the USB storage drive (Samba server) from your LAN computer:

1. Open a folder, type \\xxx.xxx.xxx.xxx in the address bar (\\192.168.0.1 here), and click

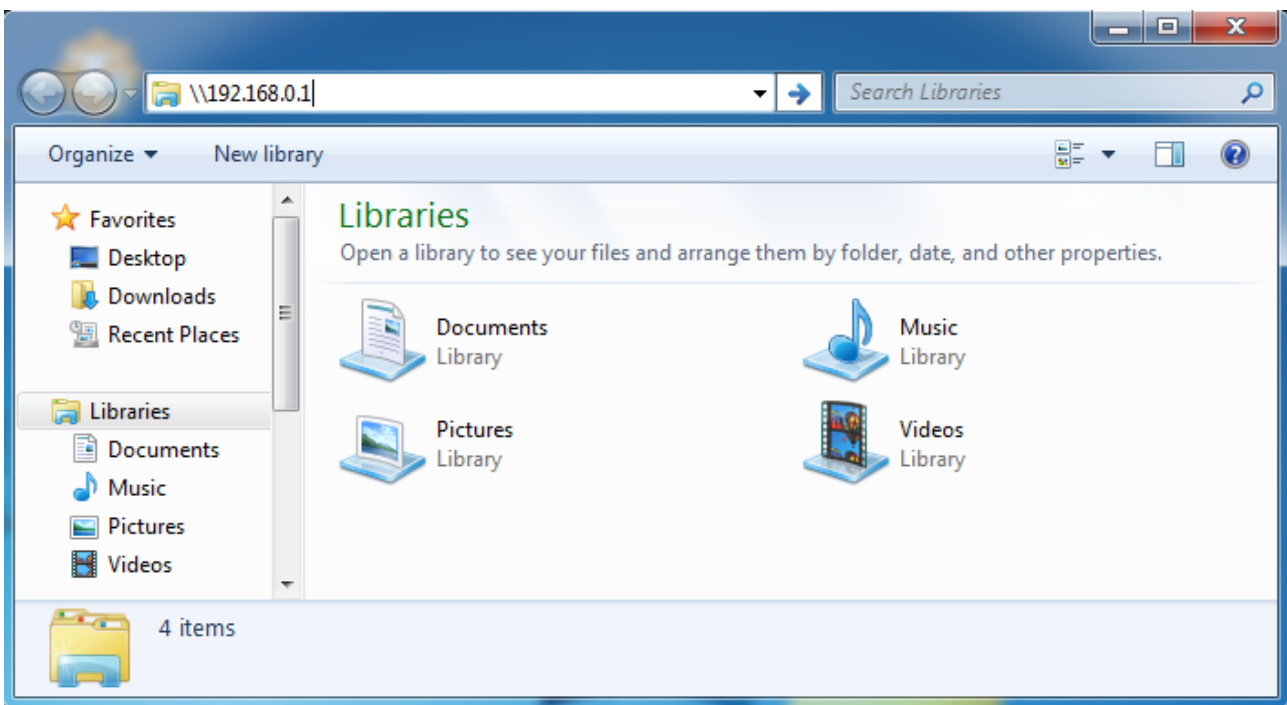

2. Type the default User name (Guest account) and the Password you just specified and click **OK**.

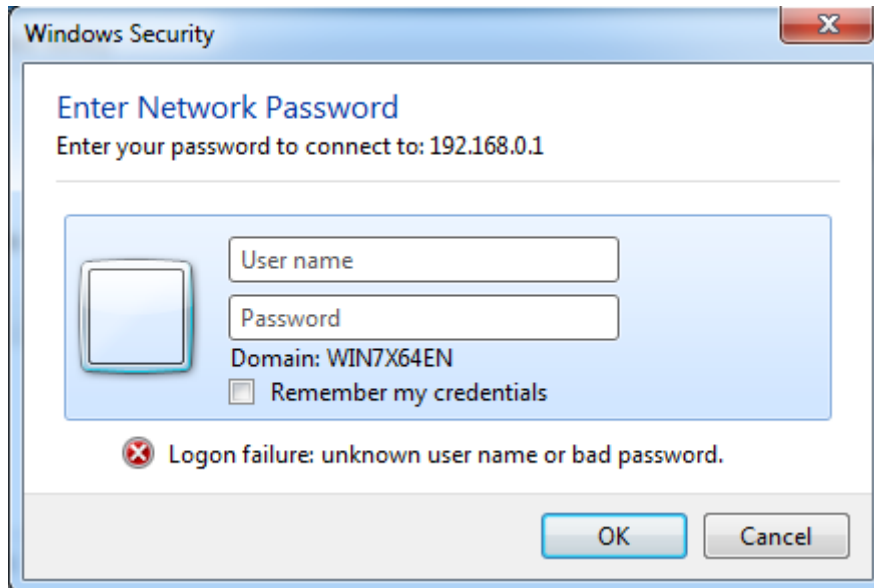

Then you can share the files on the USB storage drive.

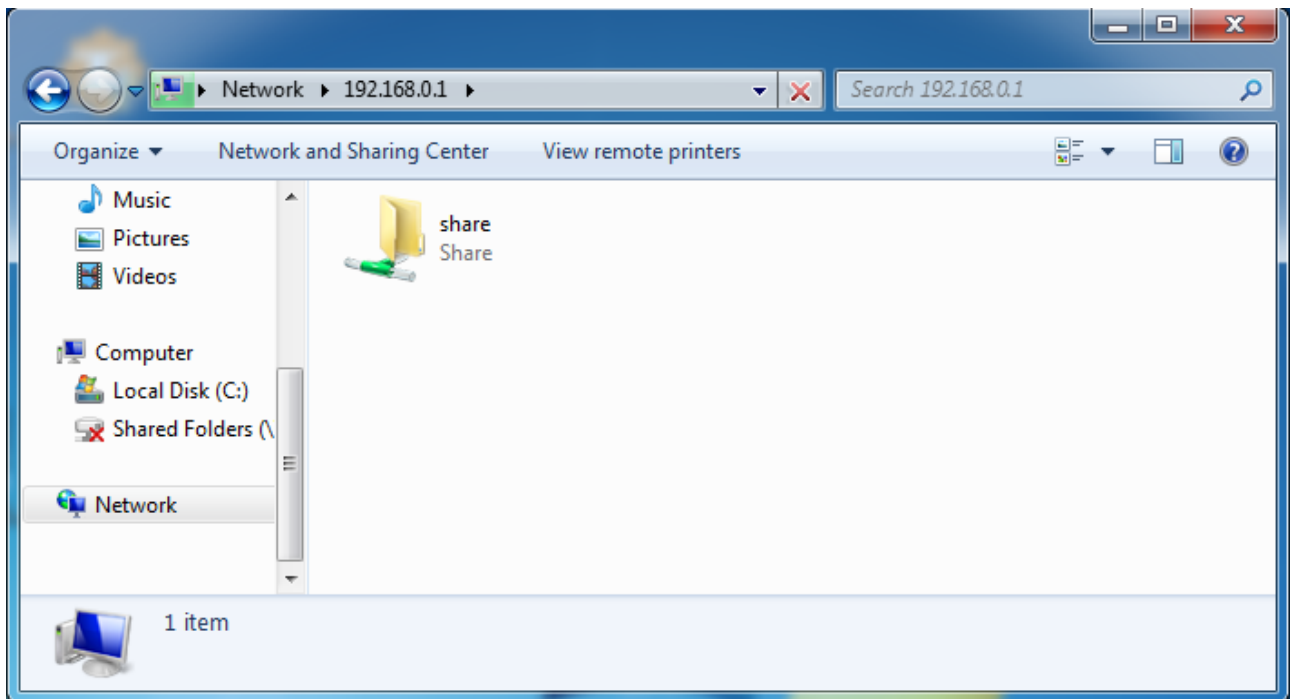

DLNA

When DLNA feature is enabled, the Router acts as a DLNA server which allows devices (such as USB storage drive, smart devices, and etc. without DLNA server) to share the media files from each other.

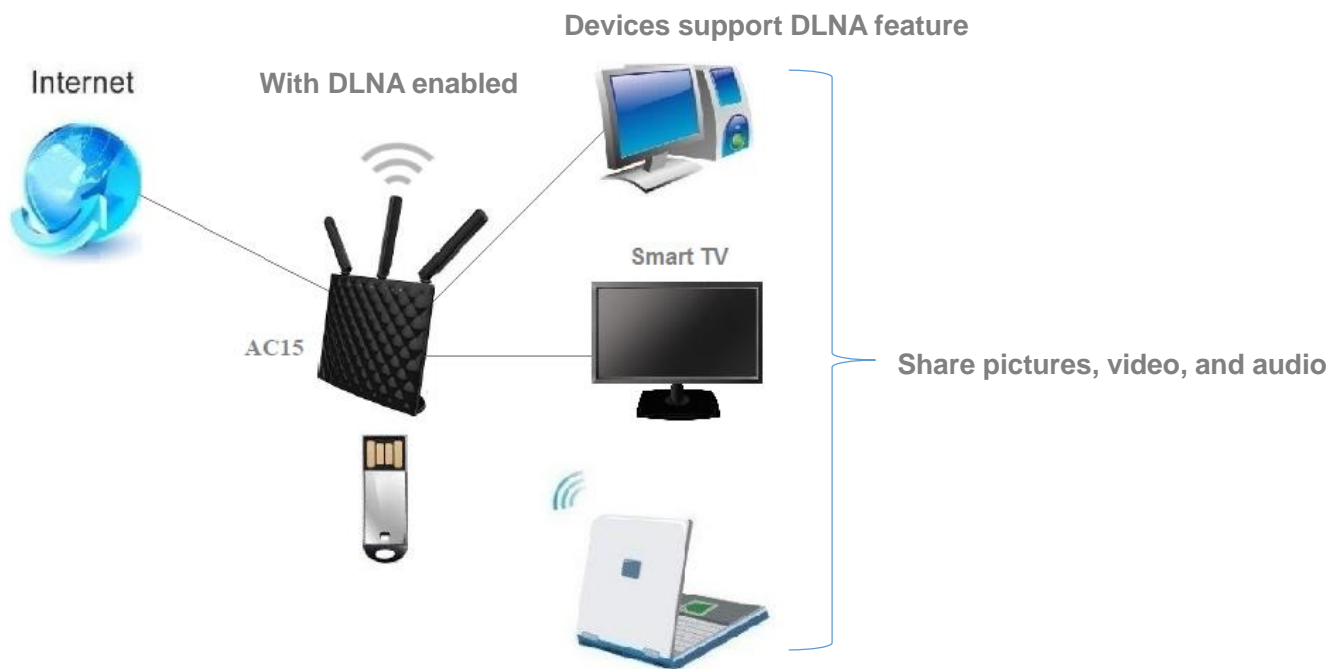

Example

You want to play the videos (in the USB storage drive) on your computer (Windows 8), you can do as follows:

Insert your USB storage drive into the USB port of the Router.

To enable DLNA server of your computer:

- 1 Right-click  icon on the bottom right corner of the desktop on your computer, and click

Open Network and Sharing Center.

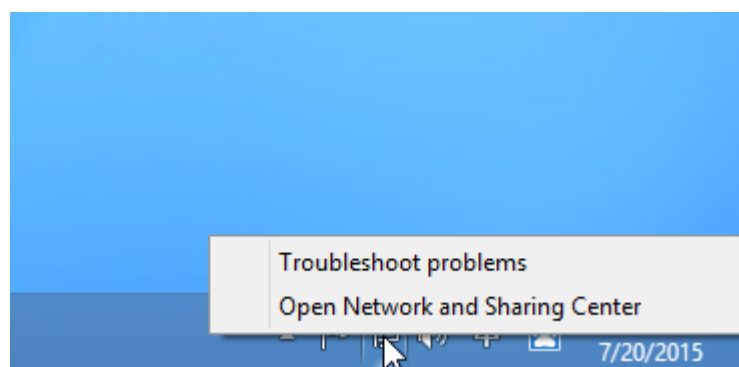

- 2 Click **Change advanced sharing settings** on the left side.

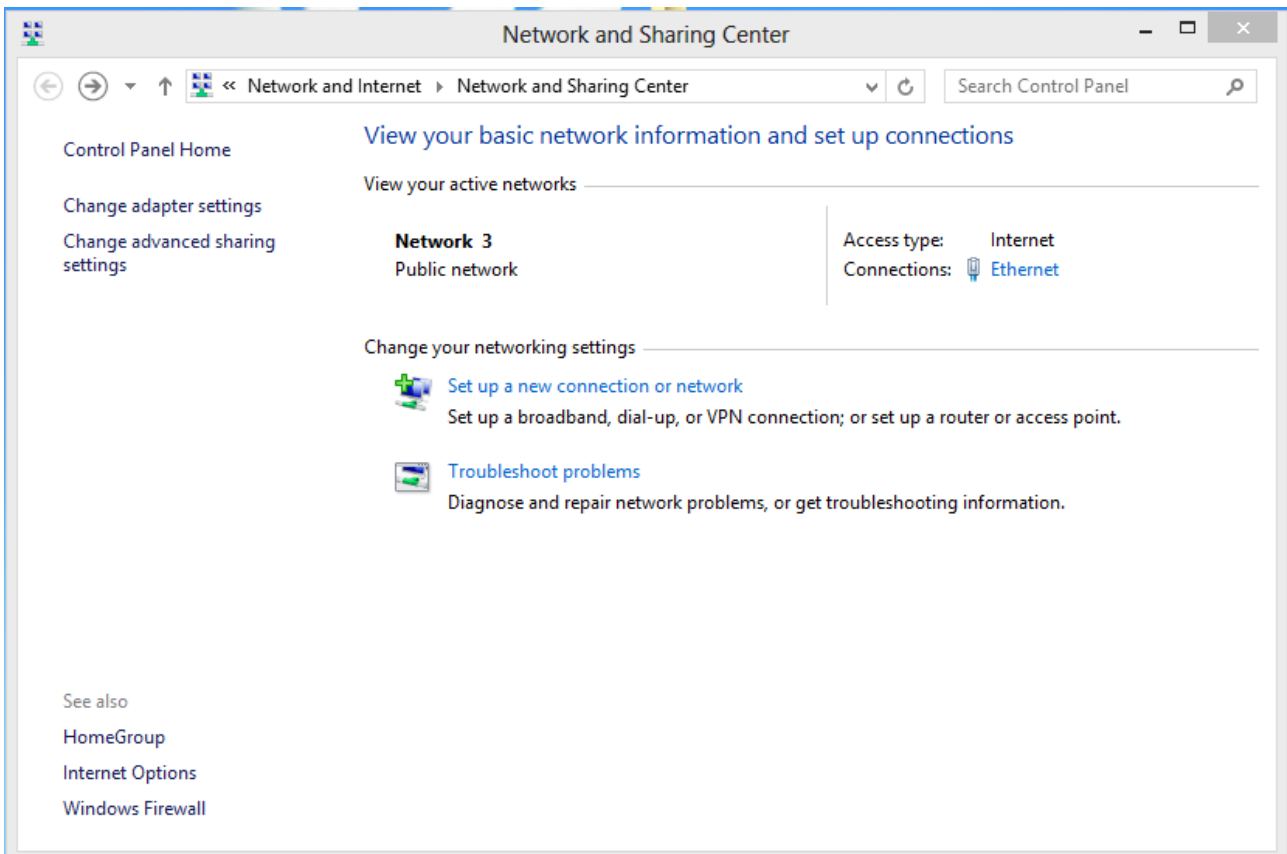

3 Click All Networks, find and click **Choose media options...** under **Media streaming**.

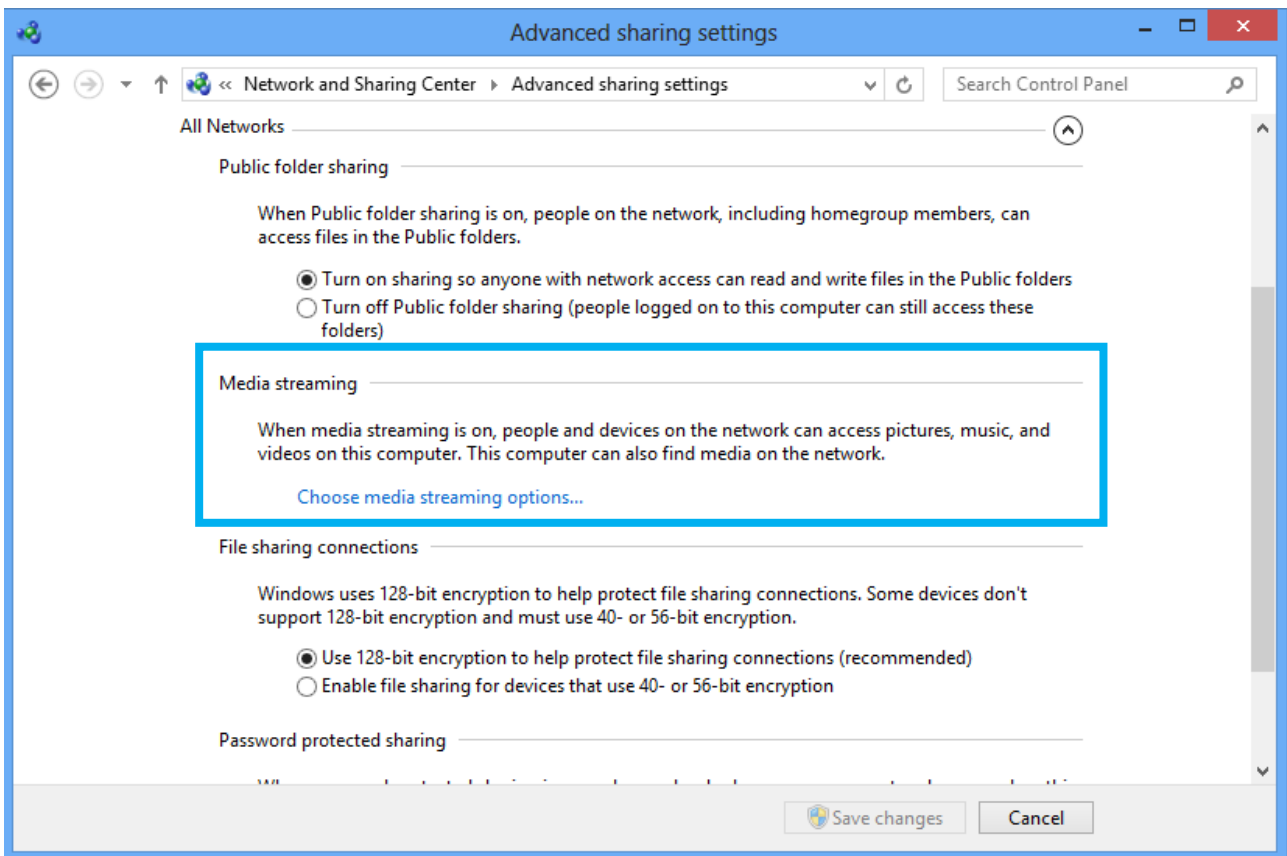

4 Click **Turn on media streaming** button.

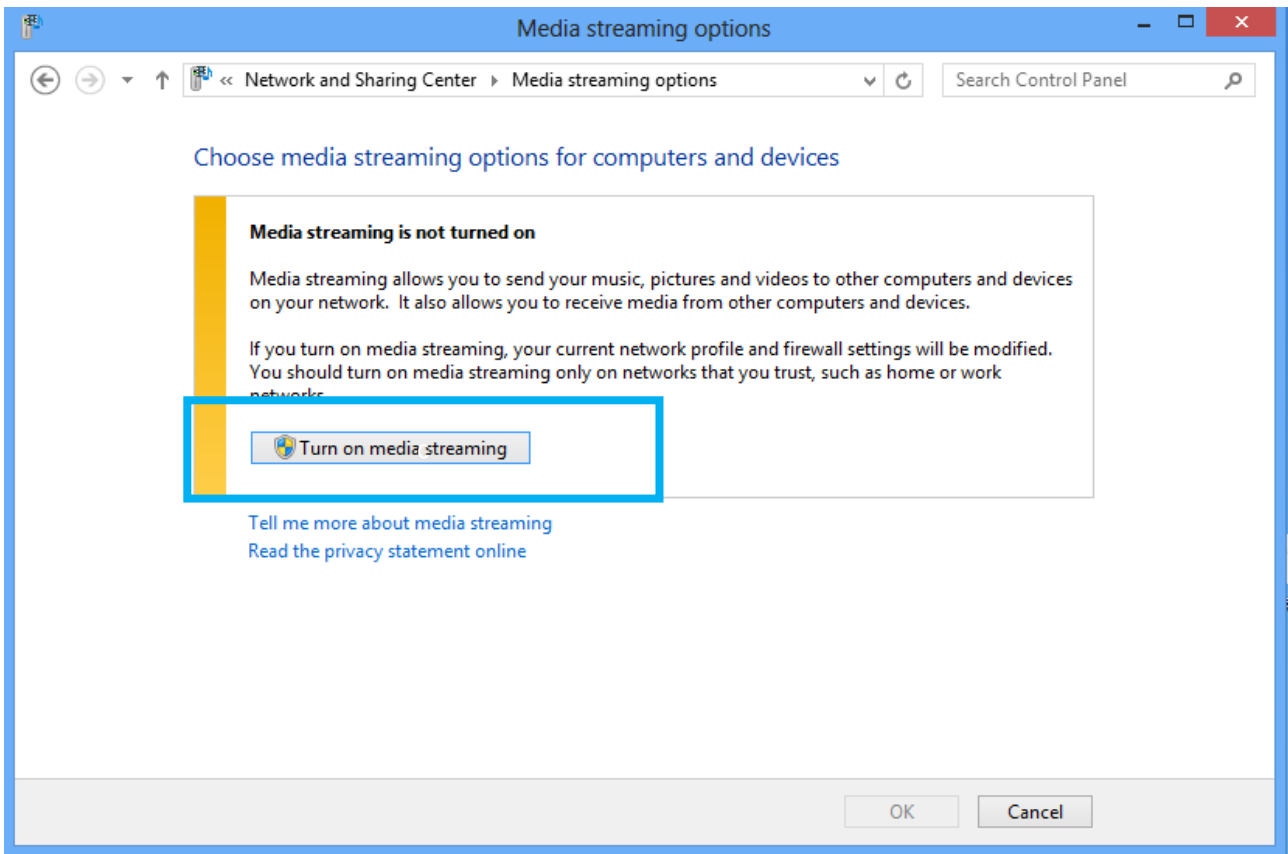

5 If the following page appears, click **Windows services administrative tool**. If not, skip to step

10.

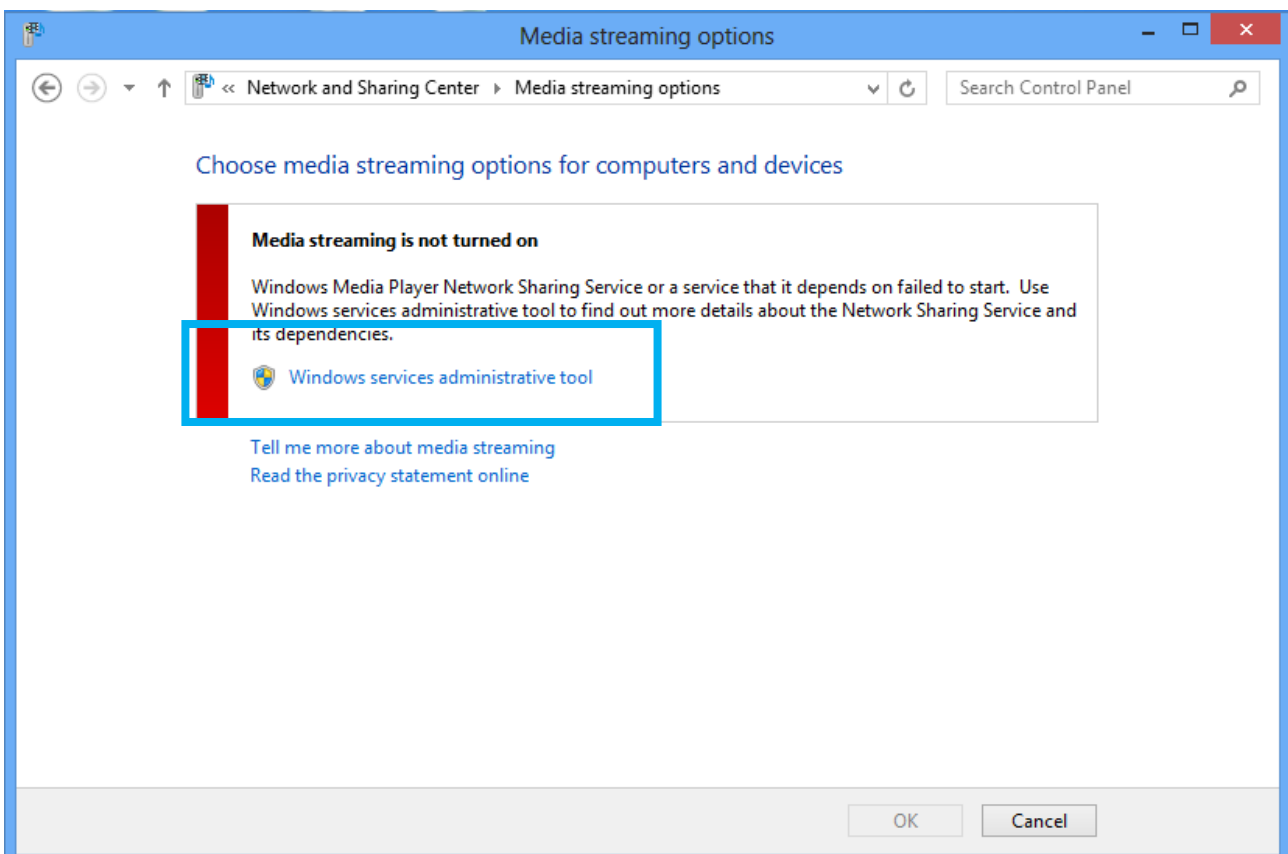

6 Find and double-click **Windows Media Player Network Sharing Service**.

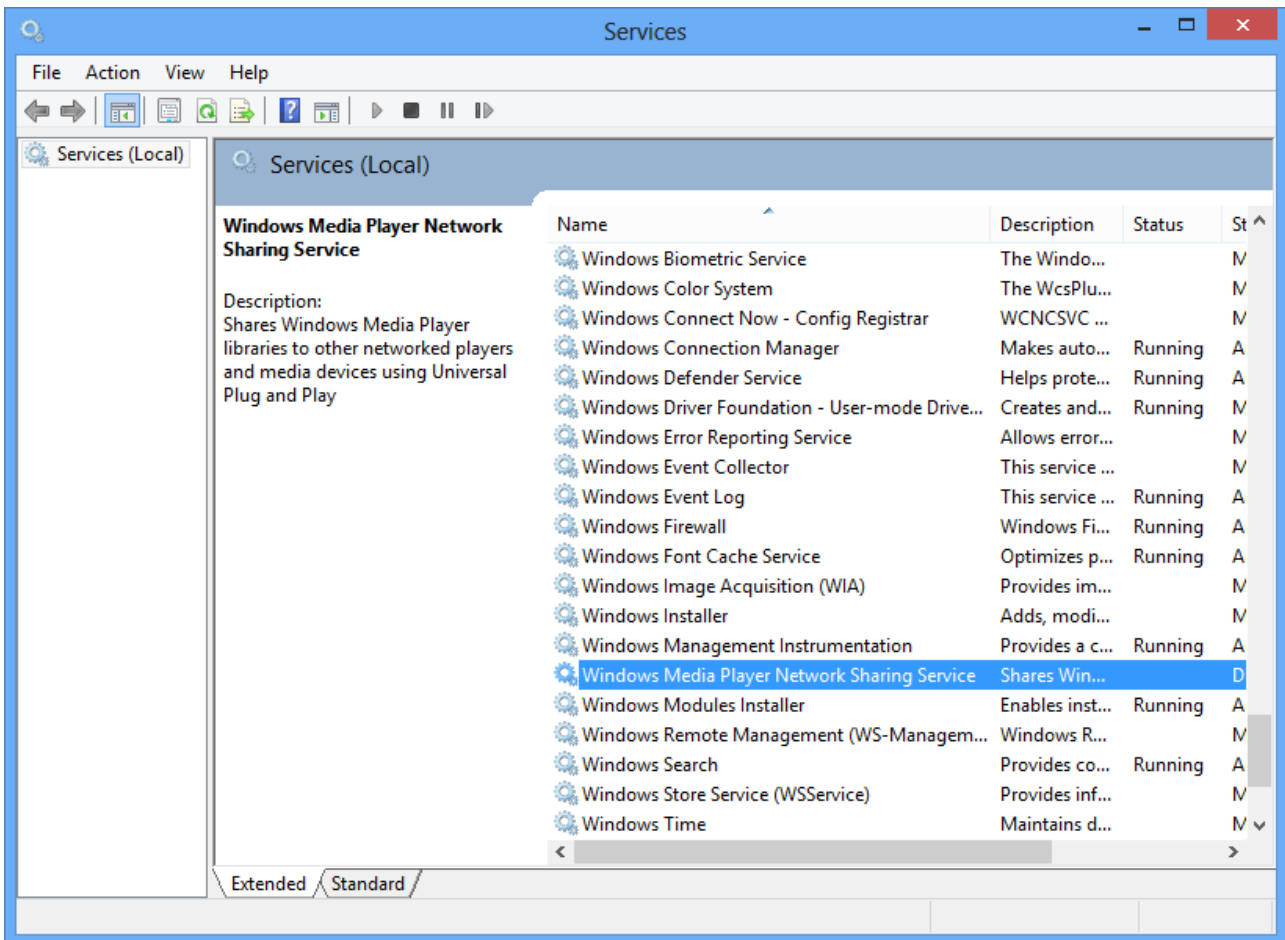

7 Change the **Startup type** to **Automatic**, and click **OK**.

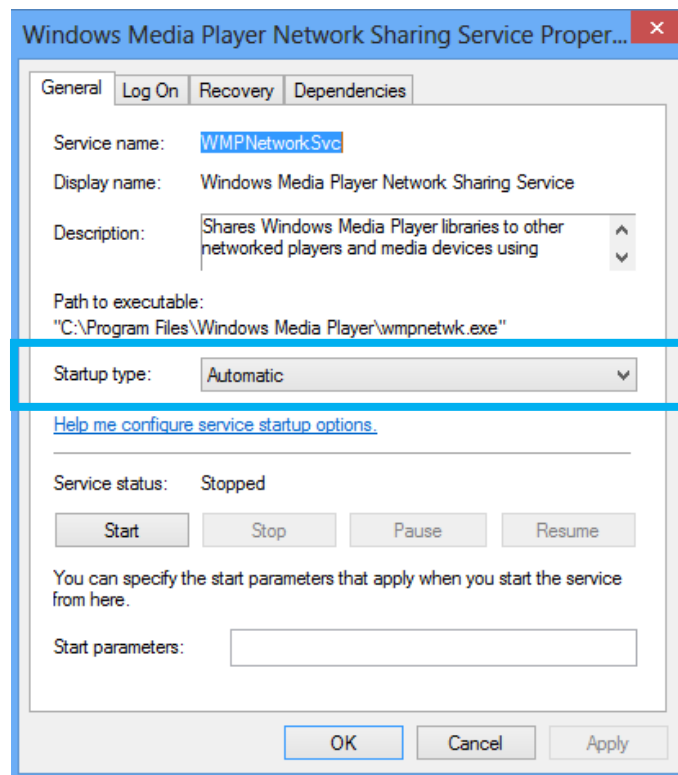

8 As the steps above, find and change the **Startup type** of **UPnP Device Host** and **SSDP Discovery** to **Automatic** respectively.

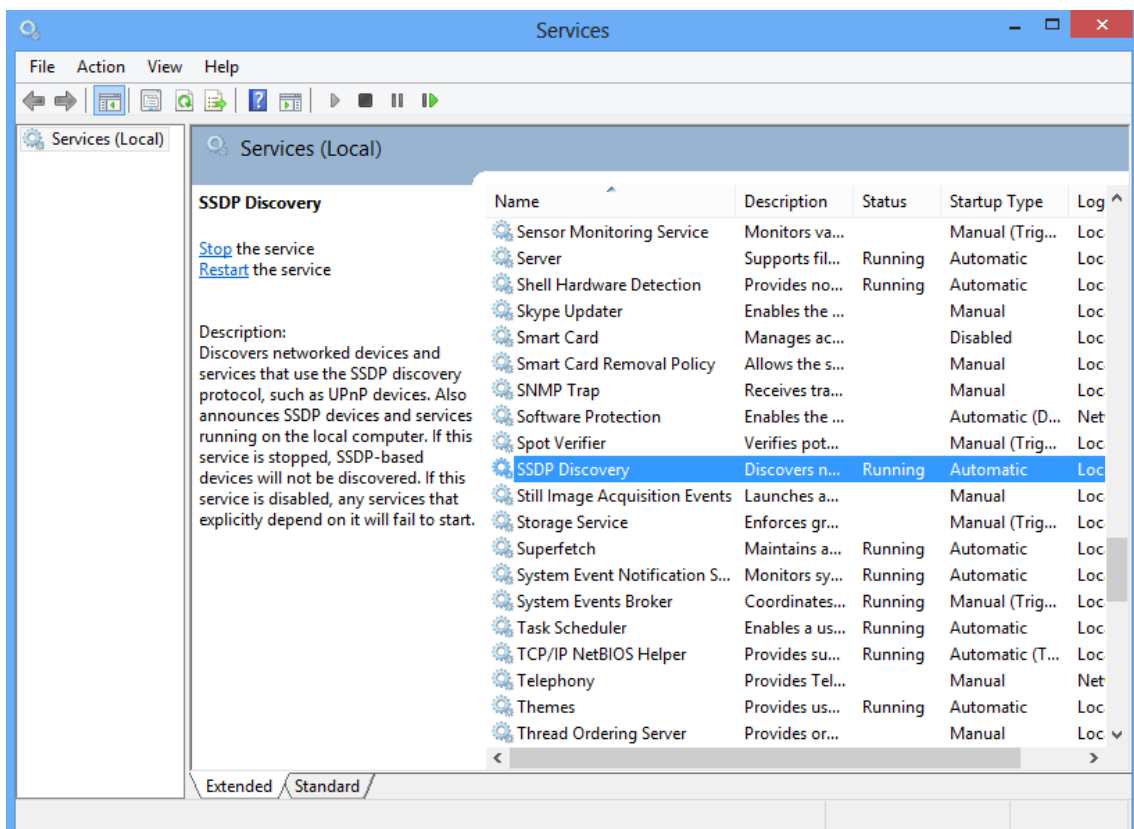
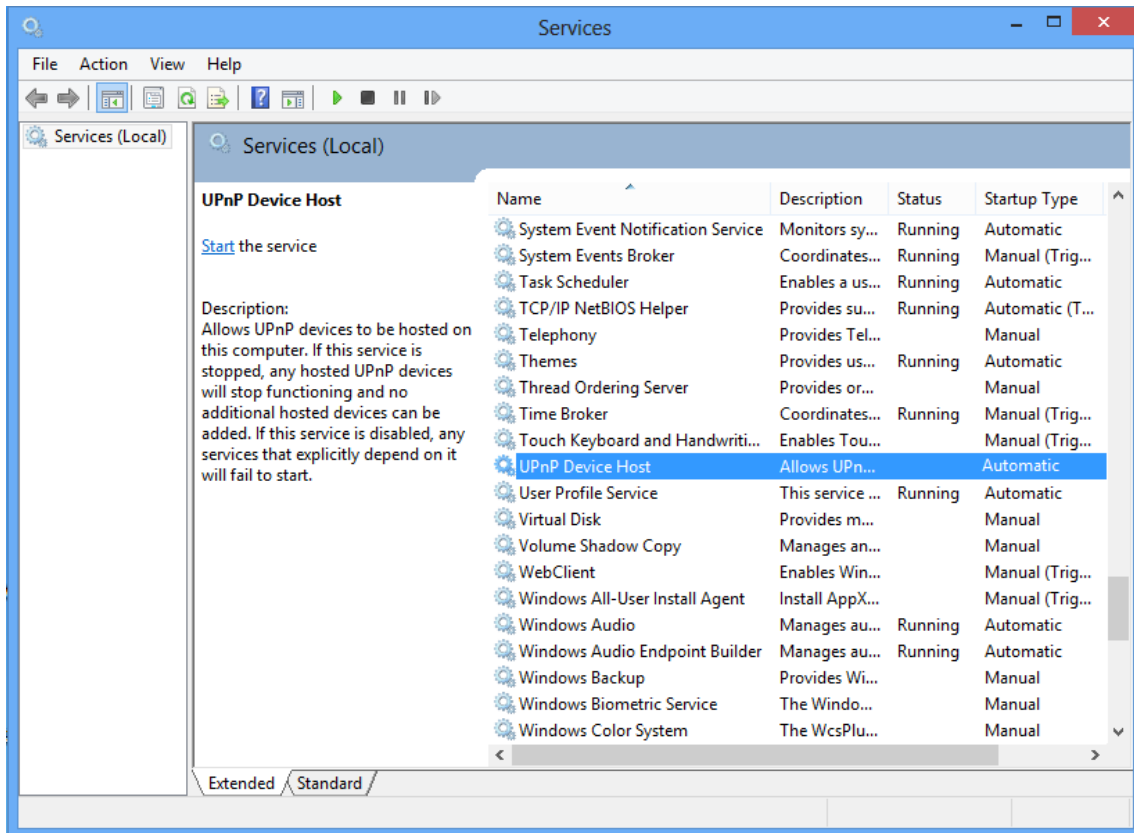

- 9 Then go back to **Media streaming options** page, and click **Turn on media streaming**.

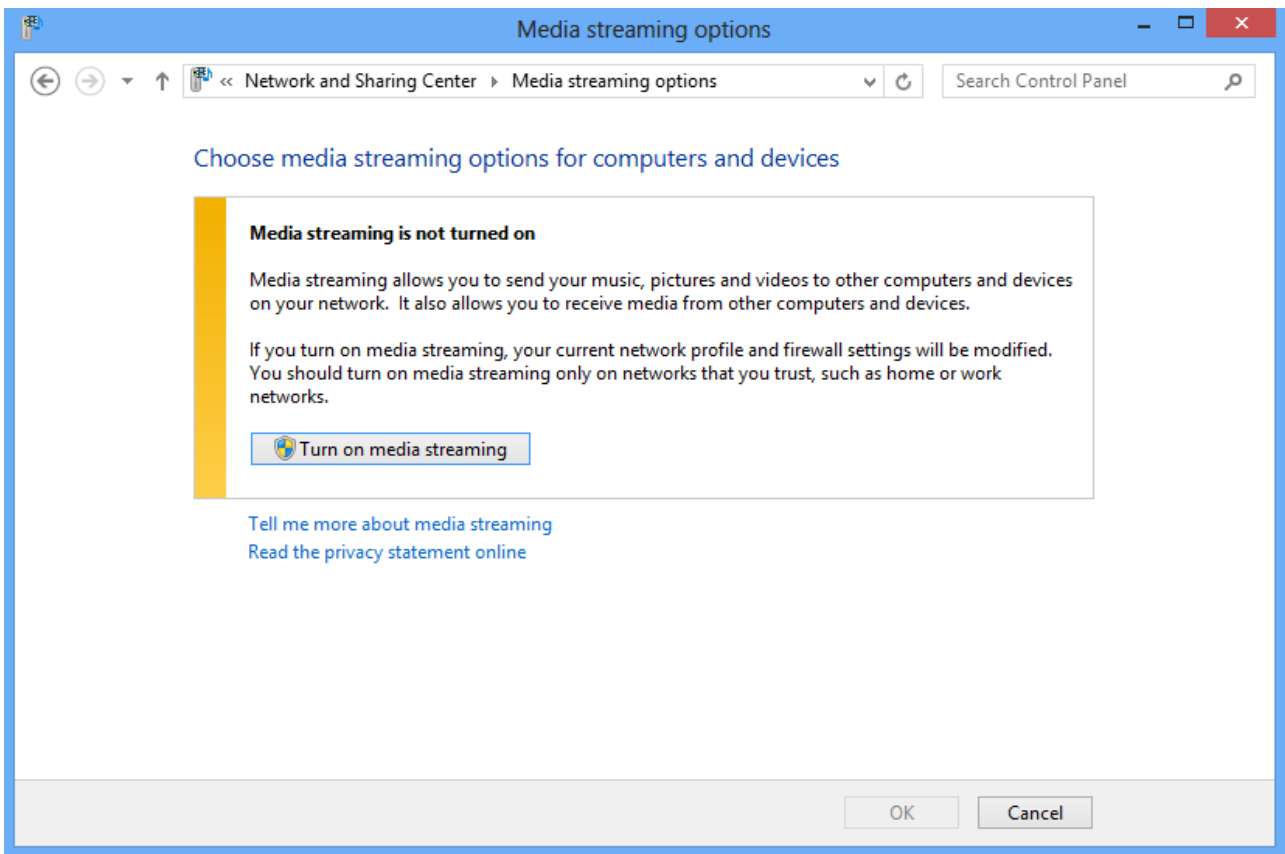

- 10 The following page will appear. Customize a name in **Name your media library**, and click **Next**.

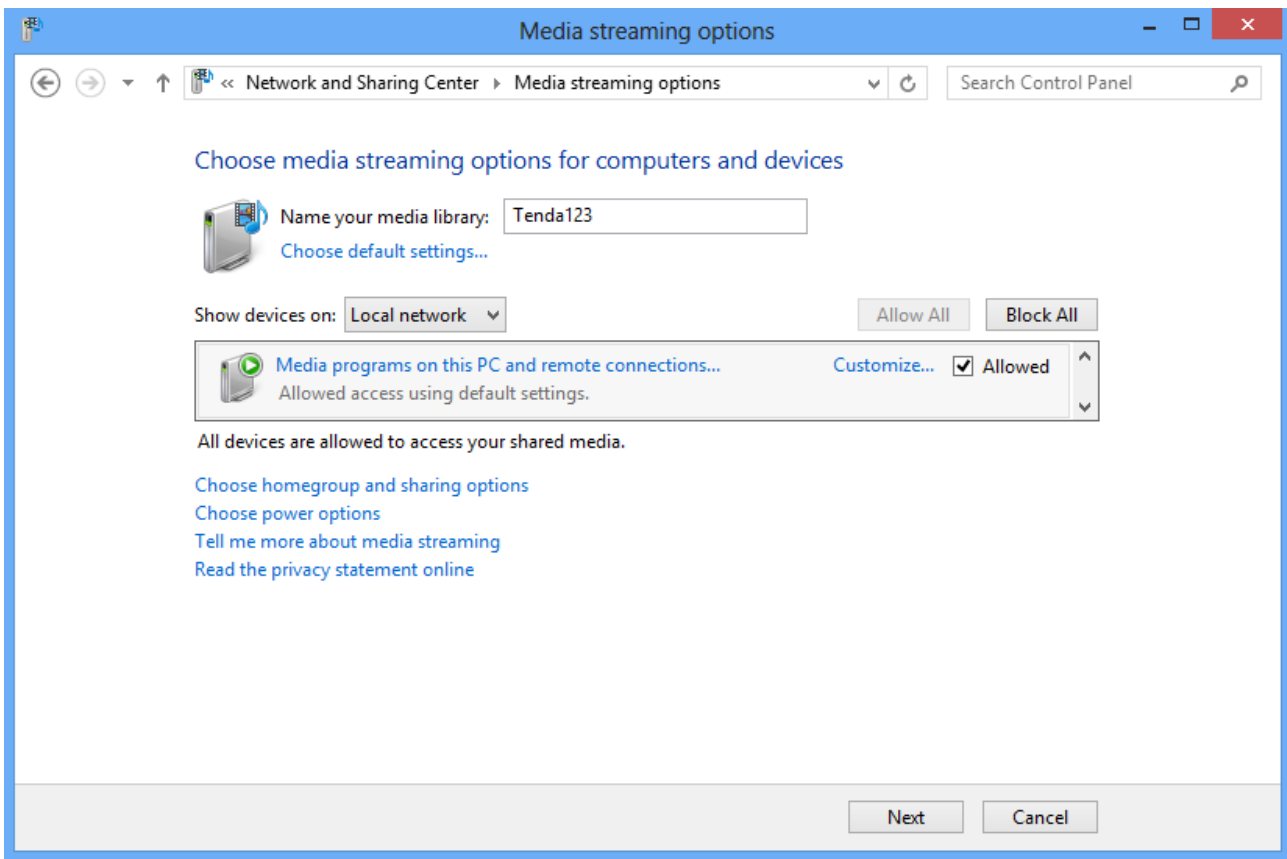

- 11 Choose files and devices you want to share, and set **Permissions** level to **Shared**.

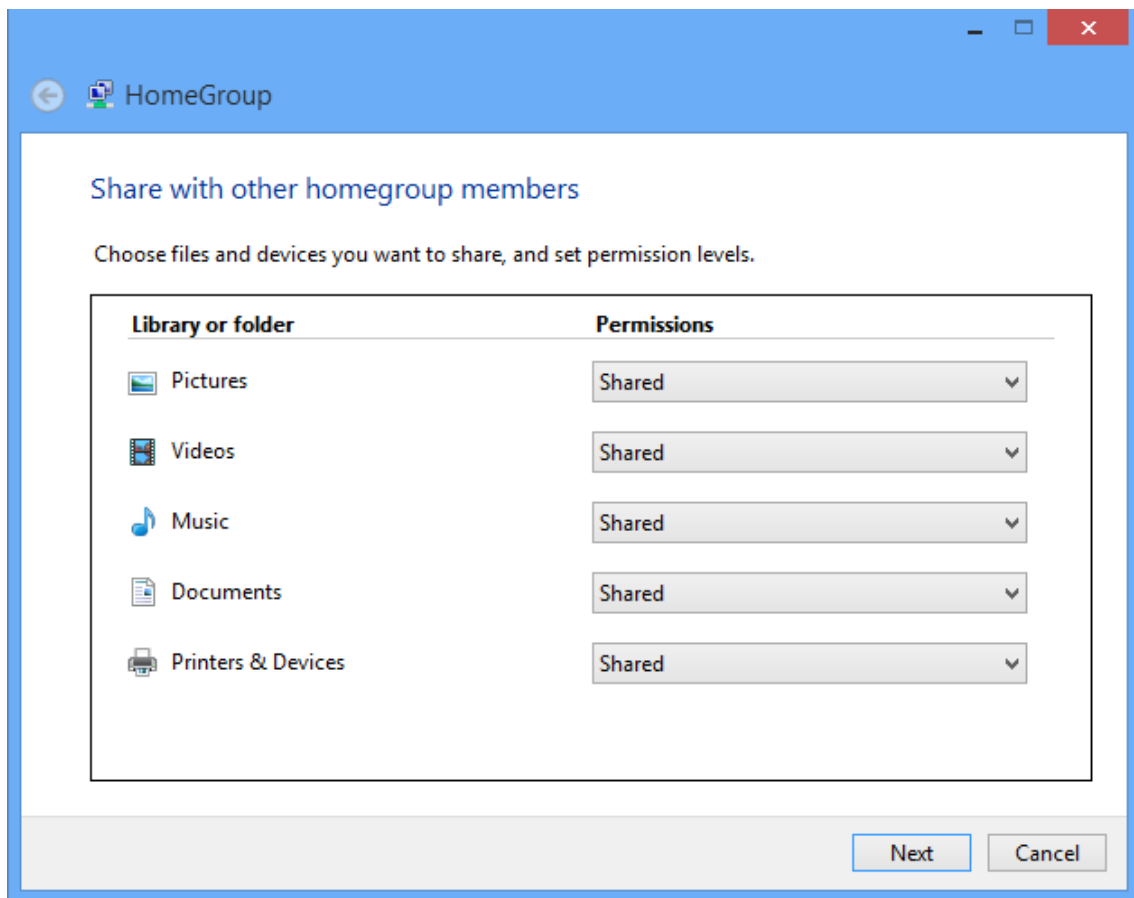

- 12 For security purpose, a password will be created. Use this password to add other computers to

your homegroup. Then you can share files between these computers. Click **Finish**.

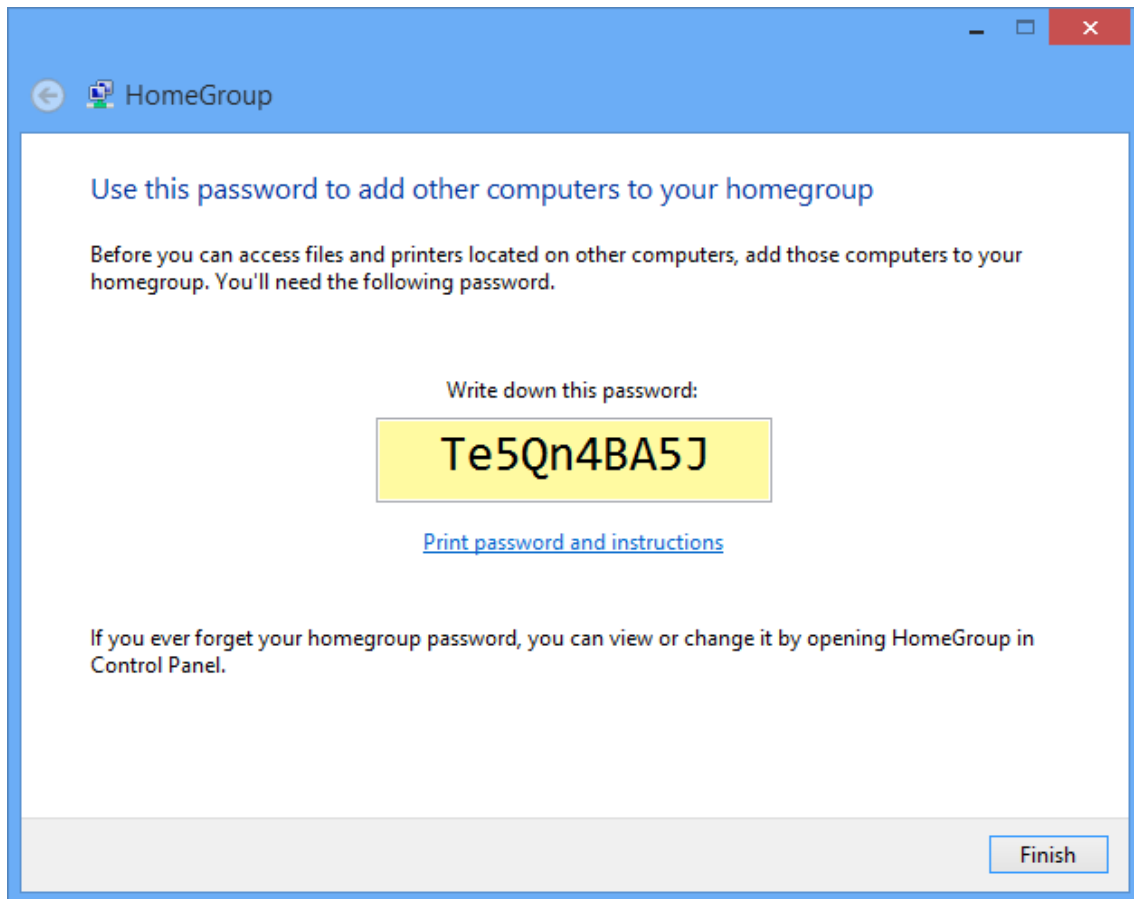

To enable DLNA feature of the Router:

Log in to the Router's User Interface, and click **USB Application > DLNA**.

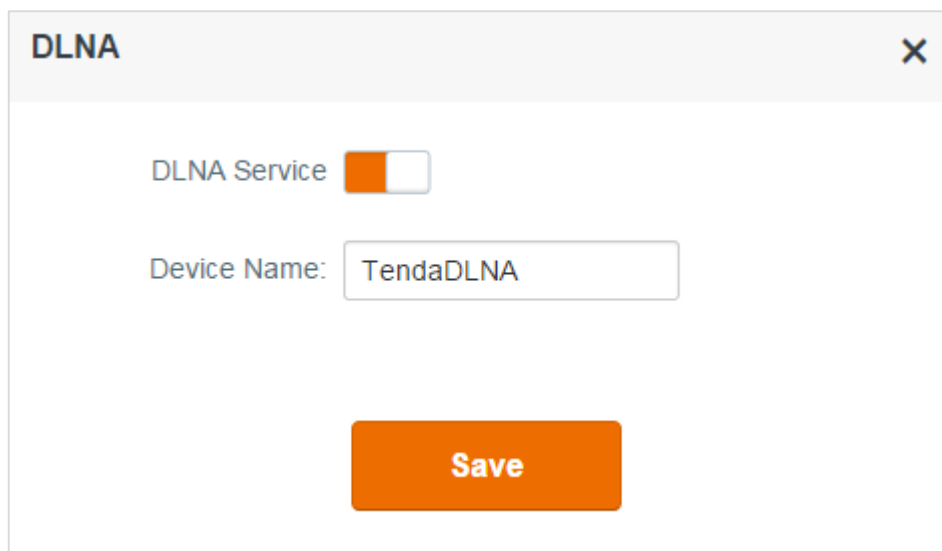

1. Click **DLNA Service** Button to enable the feature.
2. Customize a device name (default: TendaDLNA).
3. Click **Save**.

💡 Tips

1. After the DLNA enabled, you also need enable DLNA feature in other devices to establish connection. For details, please refer to the user guide of those devices.
2. If the newly-added resources don't update automatically when the DLNA server is running, try to re-enable the DLNA feature.

To play videos:

There are two methods for you to play the videos.

Method 1:

- ① Double-click the **Computer** icon on your desktop, you'll see the TendaDLNA icon under **Network Location**.

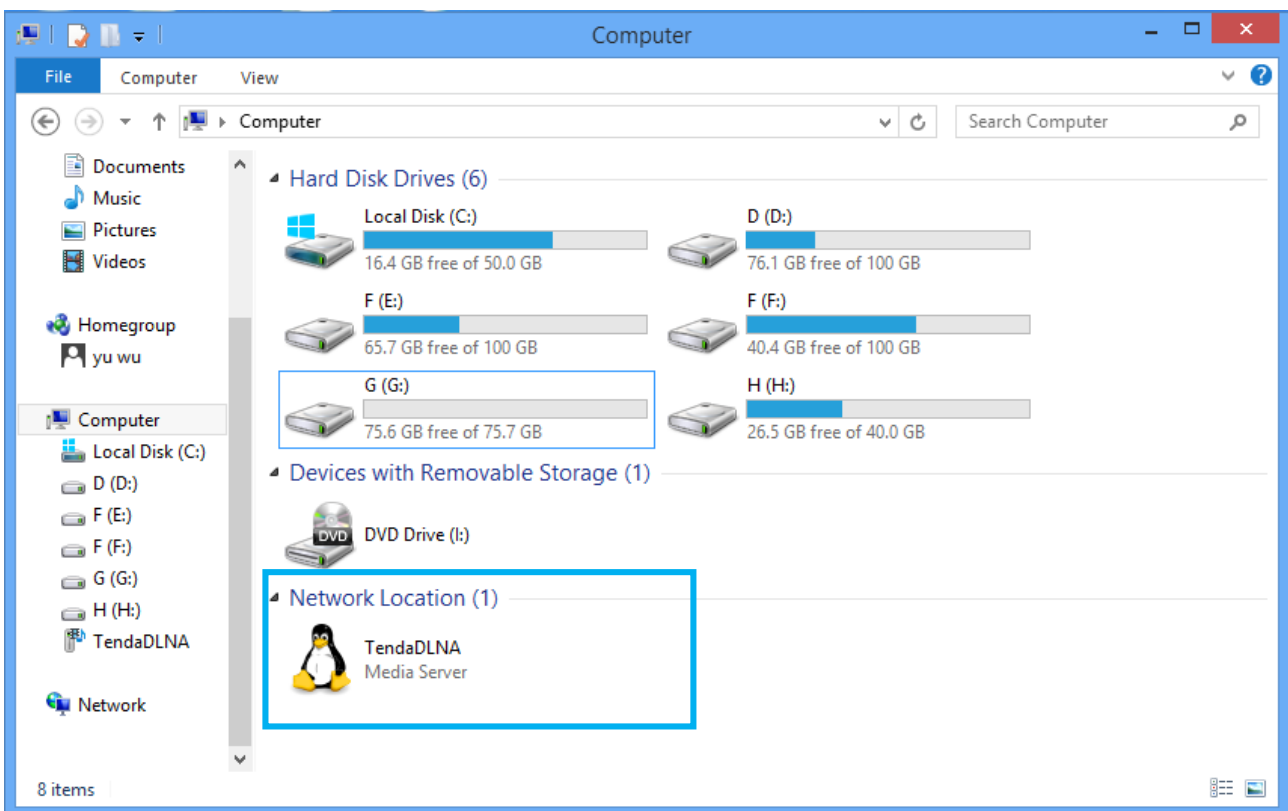

- ② Double-click the icon, you can see the resources in the USB storage drive. Then you can select the items you want to play.

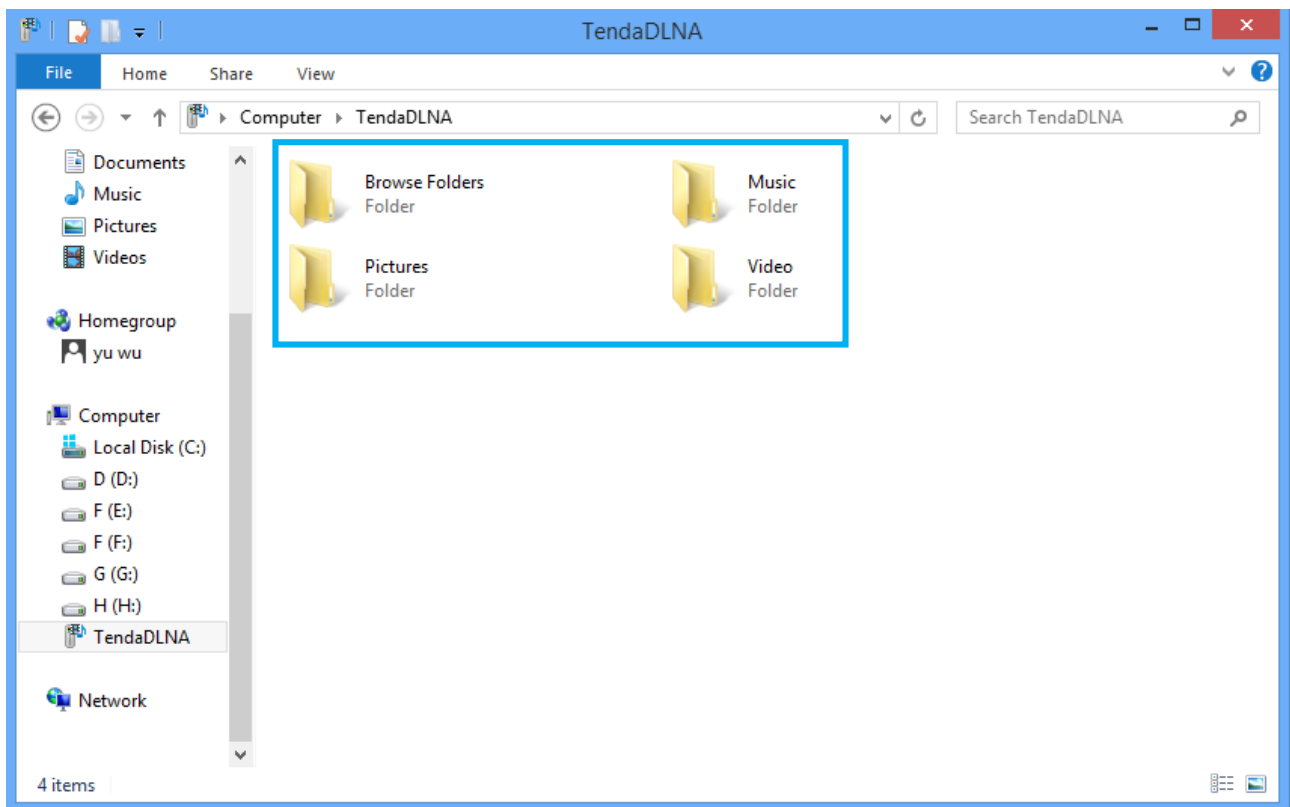

Method 2:

- 1 Search **Windows Media Player** on your computer, and click to enter it.

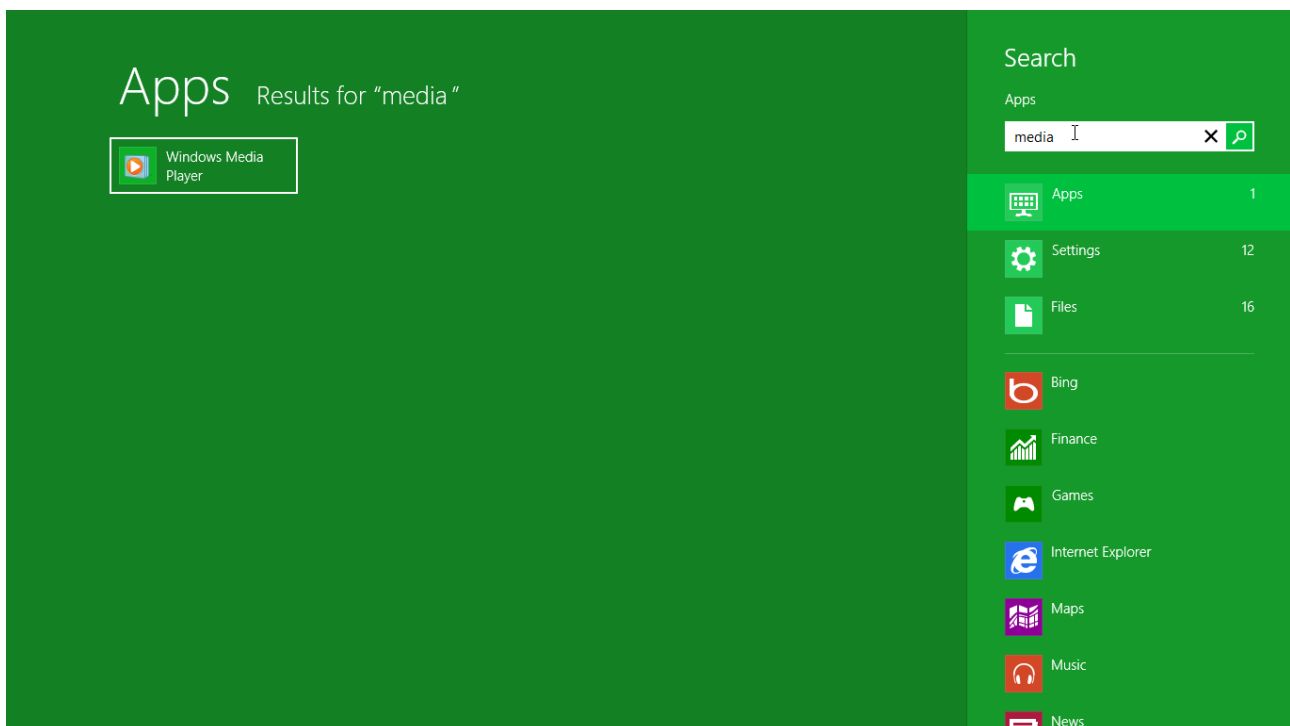

- 2 You'll see the TendaDLNA under **Other Libraries**. Then you can select the items you want to play.

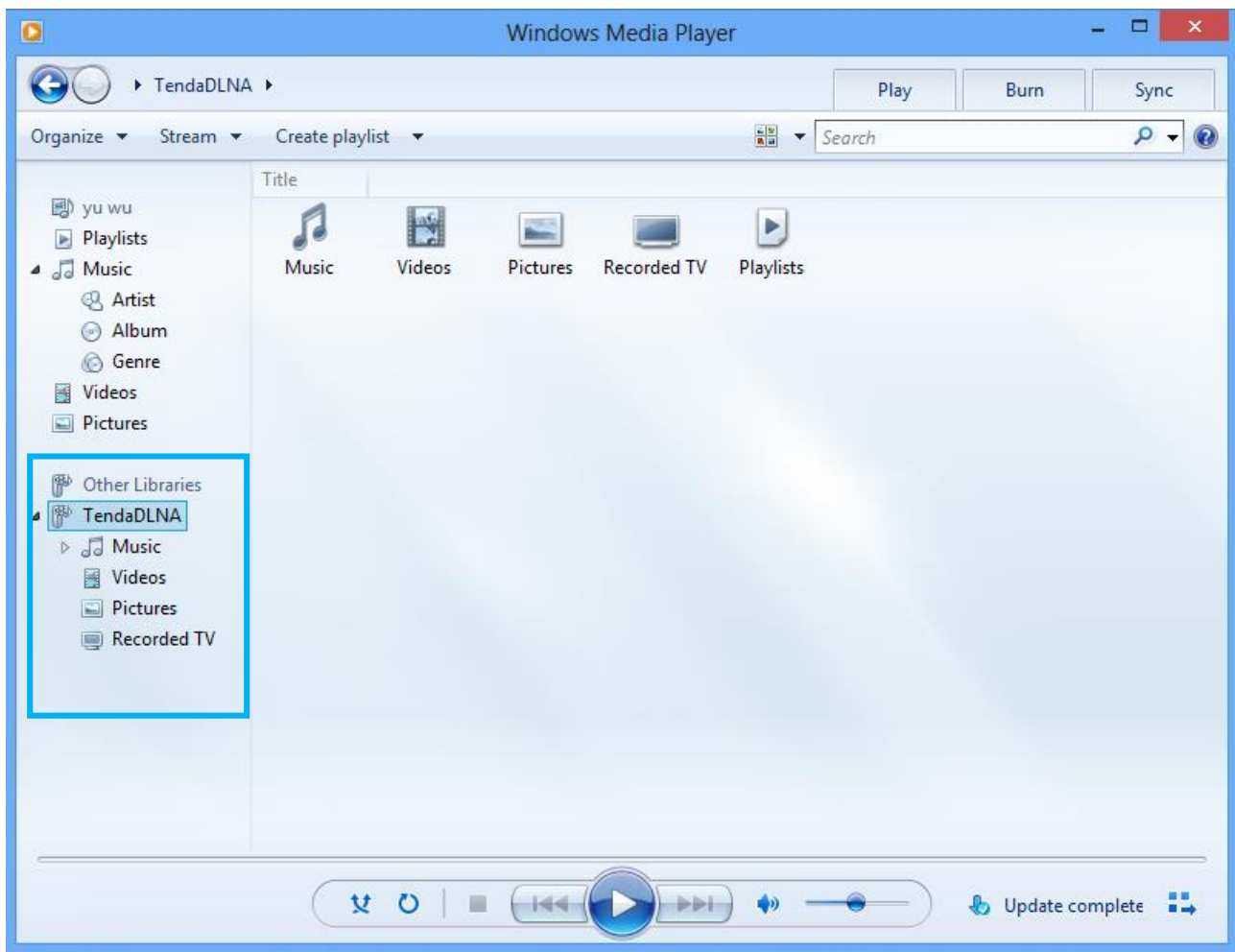

Tips

If the TendaDLNA doesn't appear, please try re-enabling DLNA feature, and refresh the **Other Libraries**.

Printer Service

Printer Service allows you to connect a USB printer to the Router's USB port, and all attached clients can use the printer to print and scan files.

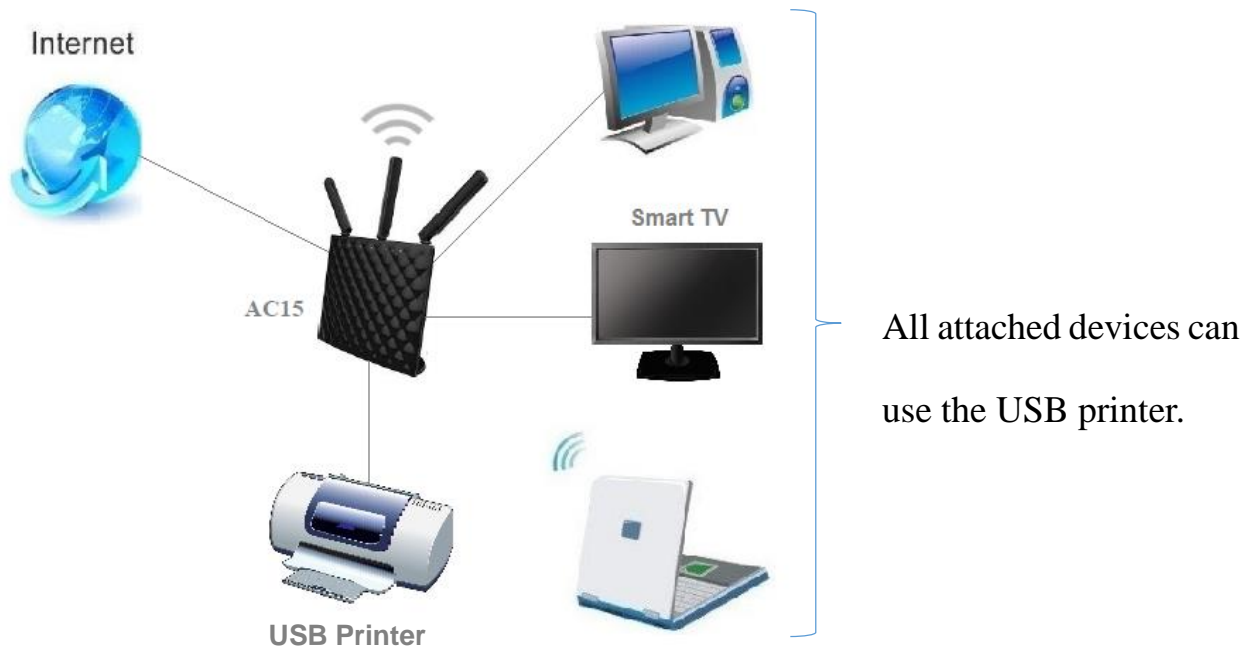

Before you use a USB printer, you need download a USB Printer Controller for USB printer from <http://files.tendacn.com/uploadfile/downloads/uploadfile/201401/AC15/AC15.rar>

Note

Verify that the printer is working normally when it is connected to your computer.
If not, please refer to the User Guide of the printer.

To install the USB Printer Controller:

- 1 Double-click the setup icon  if you download and unzip the USB Printer Controller successfully.
- 2 Select **English** and click **OK**.



- 3 Then the USB Printer Controller will start installing.

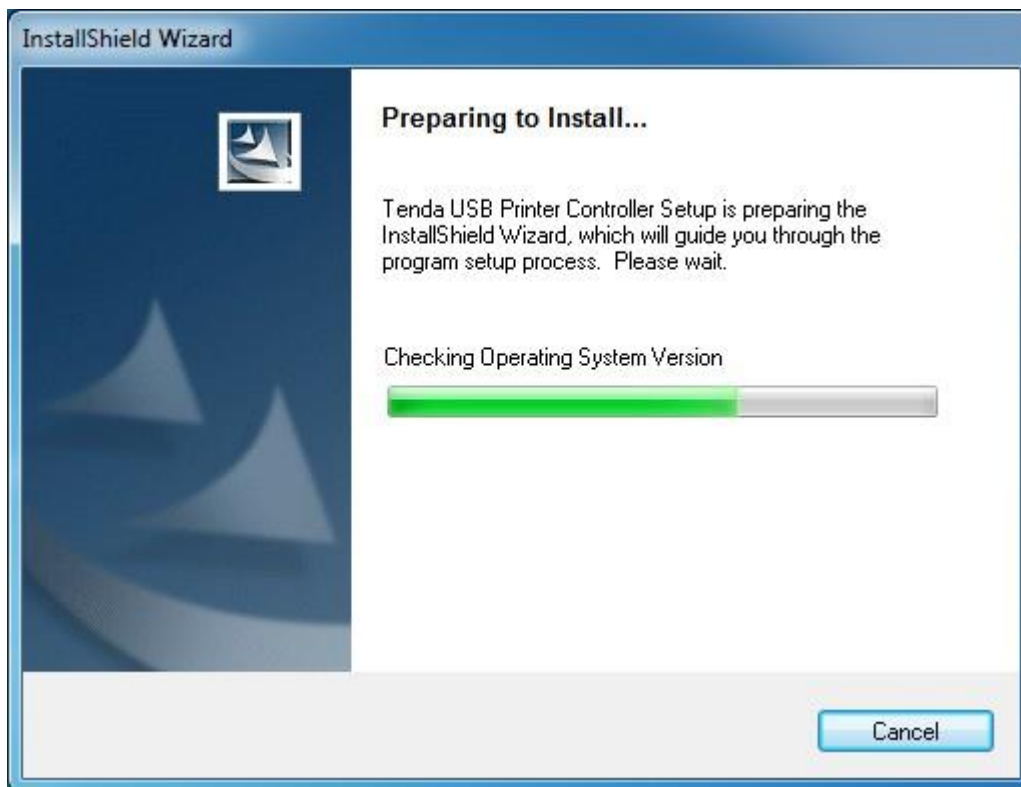

- 4 Keep click next until the following page appears, then click **Install**.

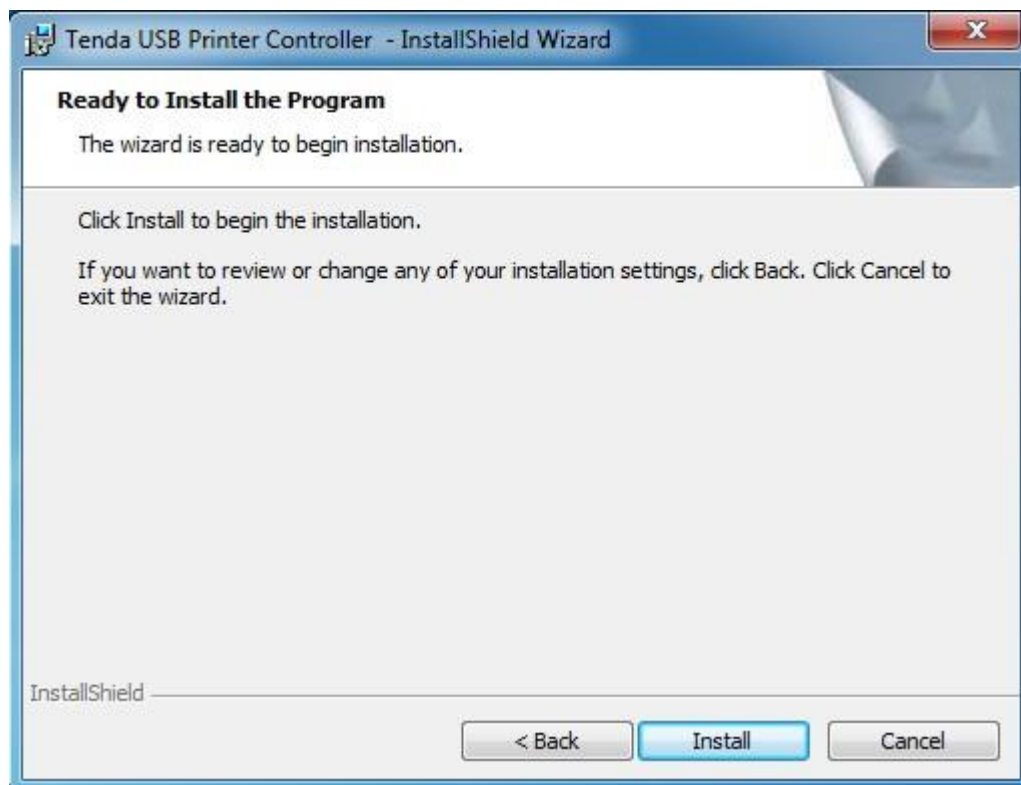

- 5 Click **Finish** when the following page appears.

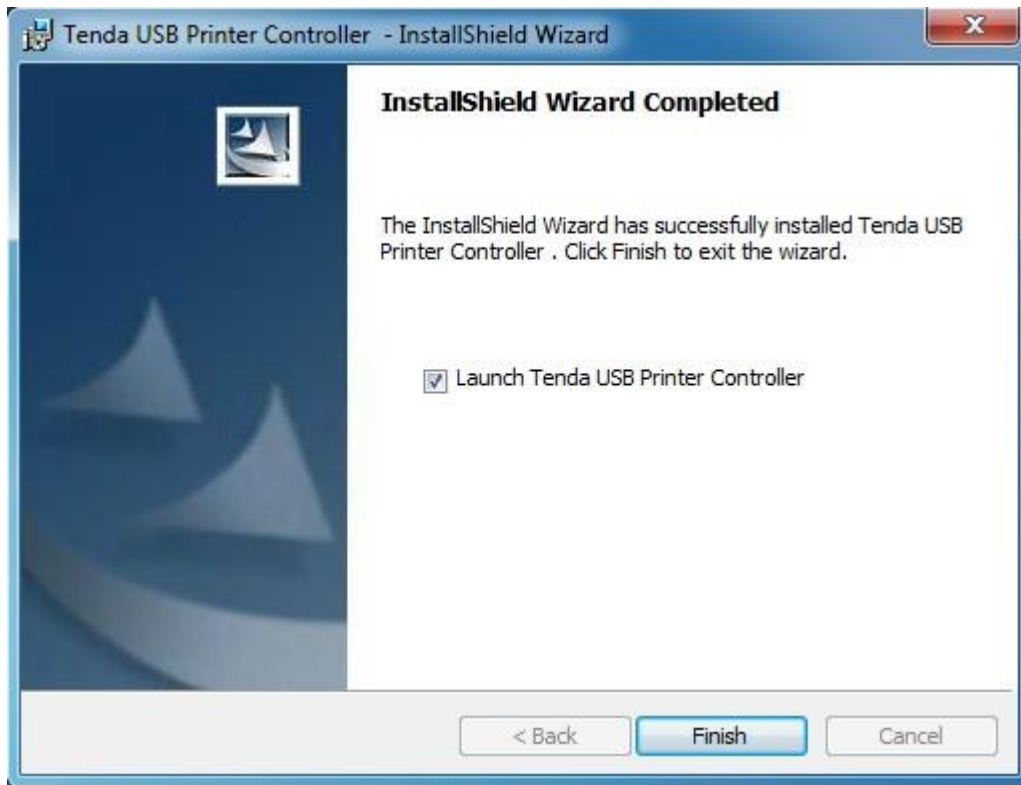

The shortcut icon of the USB Printer Controller will appear on your desktop.



To enable Printer Service feature:

Log in to the Router's User Interface, and click **USB Application > Printer Service**.



- ① Click **Printer Service** button.
- ② Click **Save**.

To print files:

- ① Connect the USB printer to the Router's USB port.

- 2 Double-click the shortcut icon of the USB Printer Controller.



- 3 The USB Printer Controller will detect the printer automatically if the **Printer Service** feature is enabled.

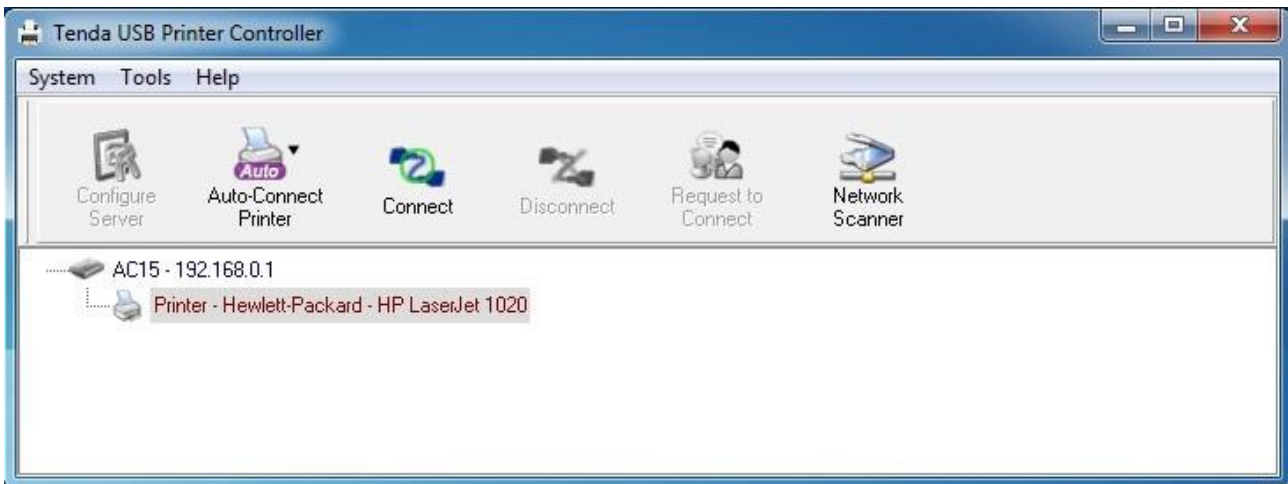

- 4 Click the **Printer**, and then **Connect**.

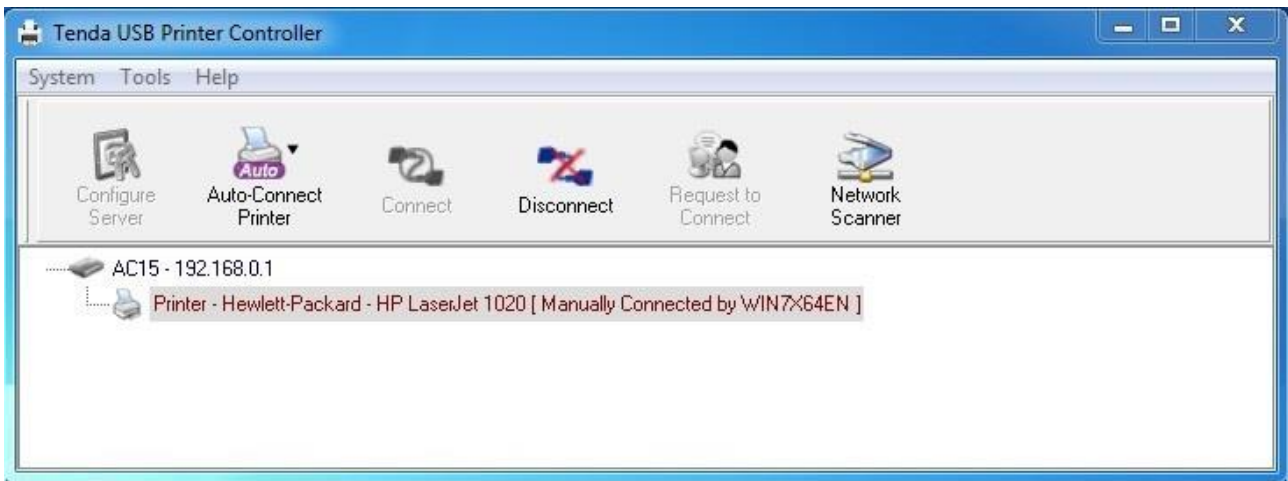

Then you can print the files!



Tips

The USB Printer Controller is compatible with most printers on the market, but if your printer cannot be detected by the USB Printer Controller, you can contact our technical support for help.

7 VPN

Virtual private network (VPN) provides a secure communication to a remote computer or remote network using a public network such as the Internet. This Router can perform as a **PPTP Server** or **PPTP/L2TP Client** here.

Click the following icons to go to the corresponding features.



PPTP Server

When the Router acts as a PPTP Server, it provides a secure virtual tunnel between your home network and a remote computer.

Example

You have a FTP server (LAN IP: 192.168.0.154) in your home network. If you want to visit the resources on the FTP server from the company's computer, you can refer to the following procedures.

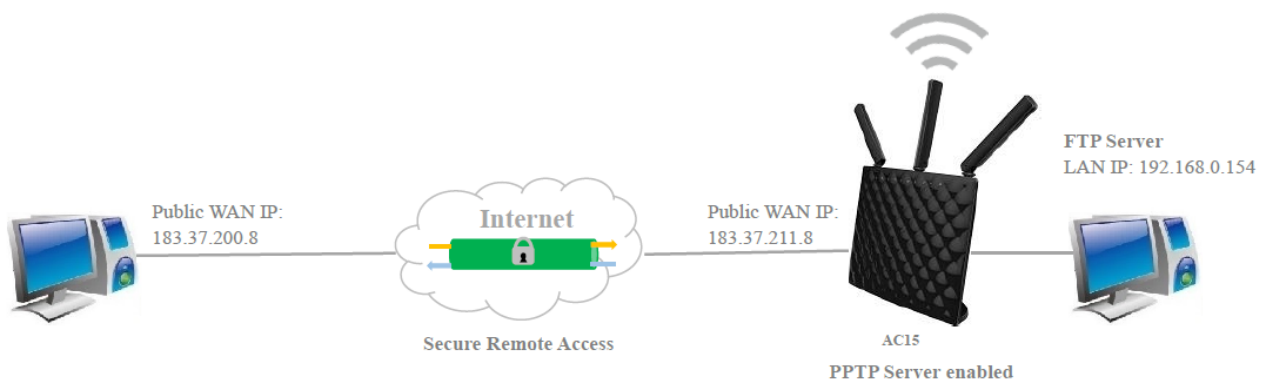

Configuration

To set up a PPTP Server:

Log in to the Router's User Interface, and click **VPN > PPTP Server**.

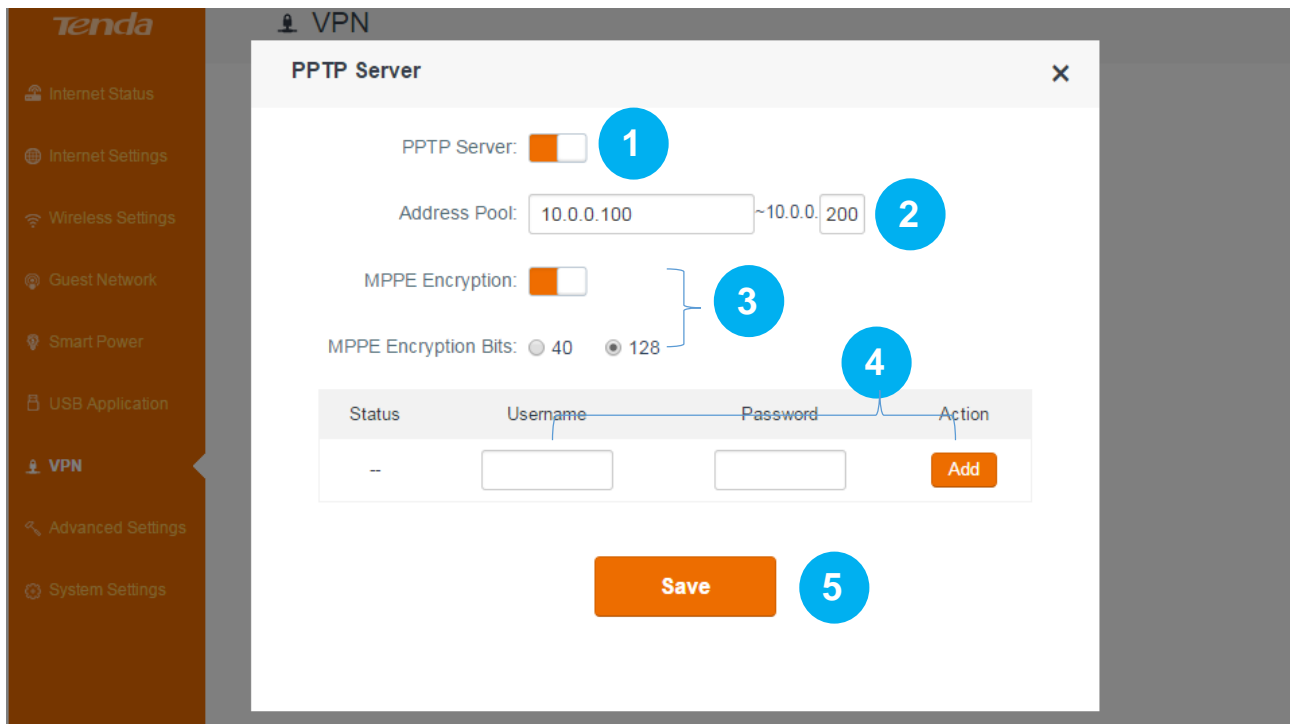

- 1 Click **PPTP Server** button to enable the feature.
- 2 Set up an IP range for PPTP clients which should not overlap with the IP address of the PPTP server.
- 3 Enable **MPPE Encryption**, and select an encryption bits, **40** or **128** according to your needs.
- 4 Specify a **username** and **password** for your PPTP server, and click **Add**.
- 5 Click **Save**.

To establish a VPN connection:

To access the PPTP server, you need establish a VPN connection on your computer in the company.

- 1 Click the icon  on the bottom right corner of your desktop. Click **Open Network and Sharing Center**.

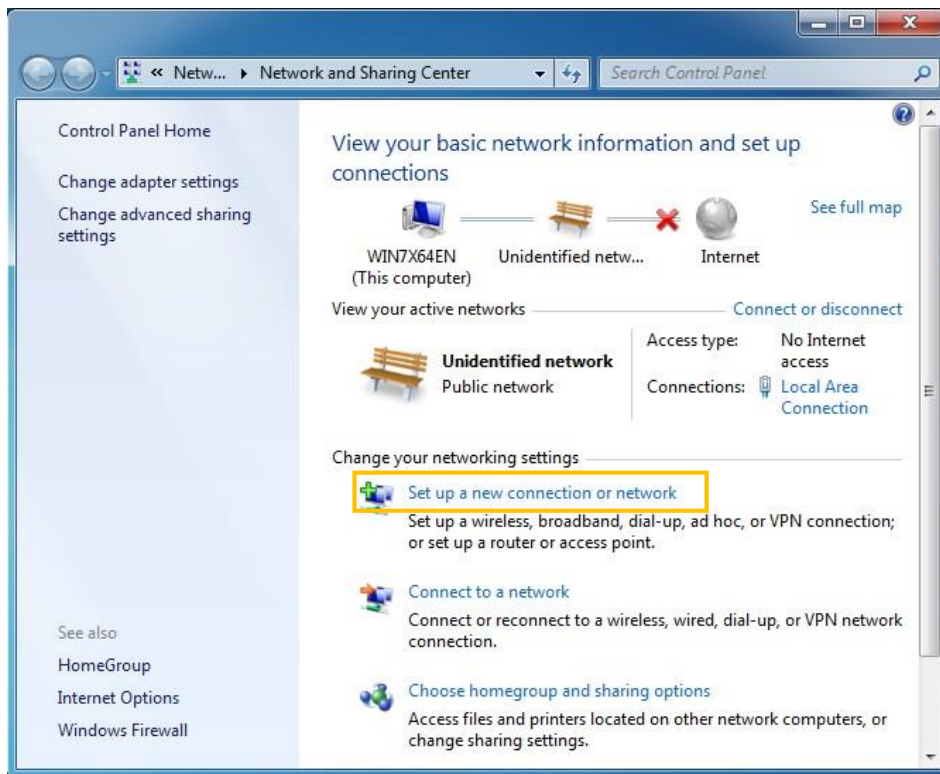

2 Click **Set up a new connection or network > Connect to a workplace > Use my Internet connection (VPN)**.

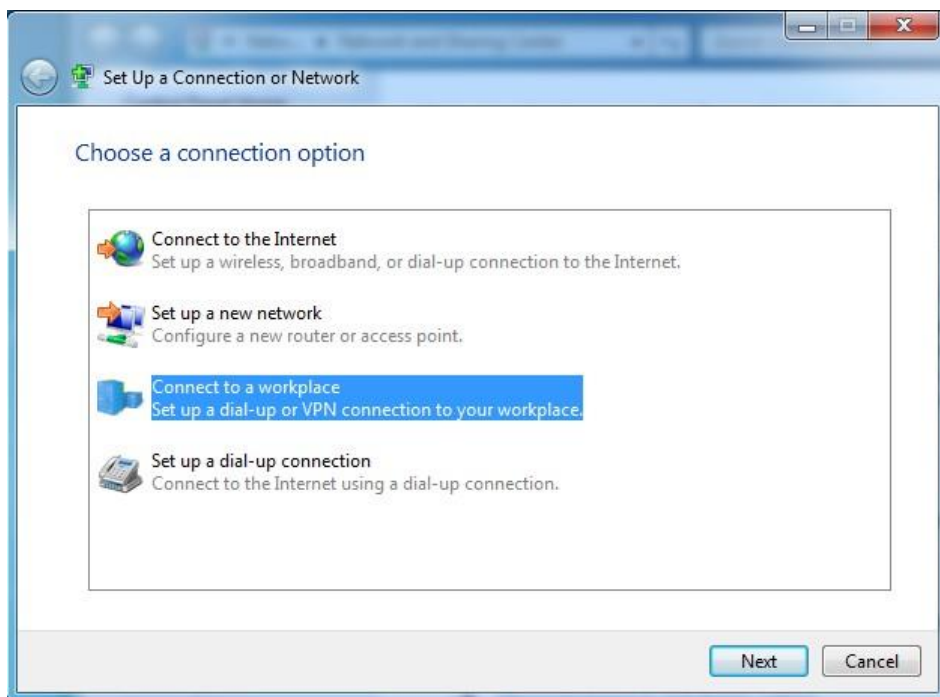

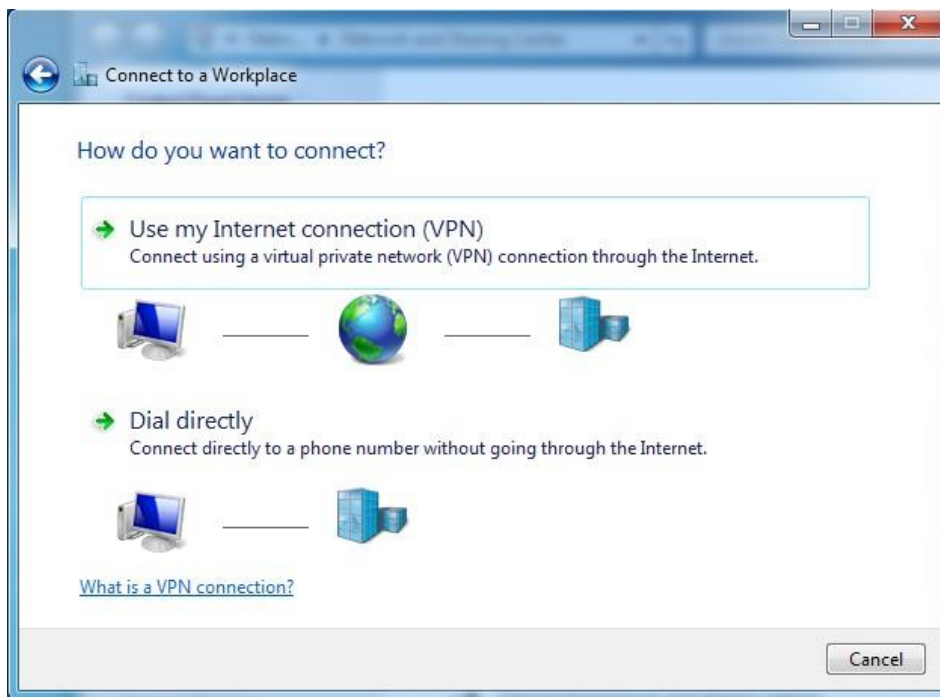

3 Select **Let me decide later**, and click **Next**.

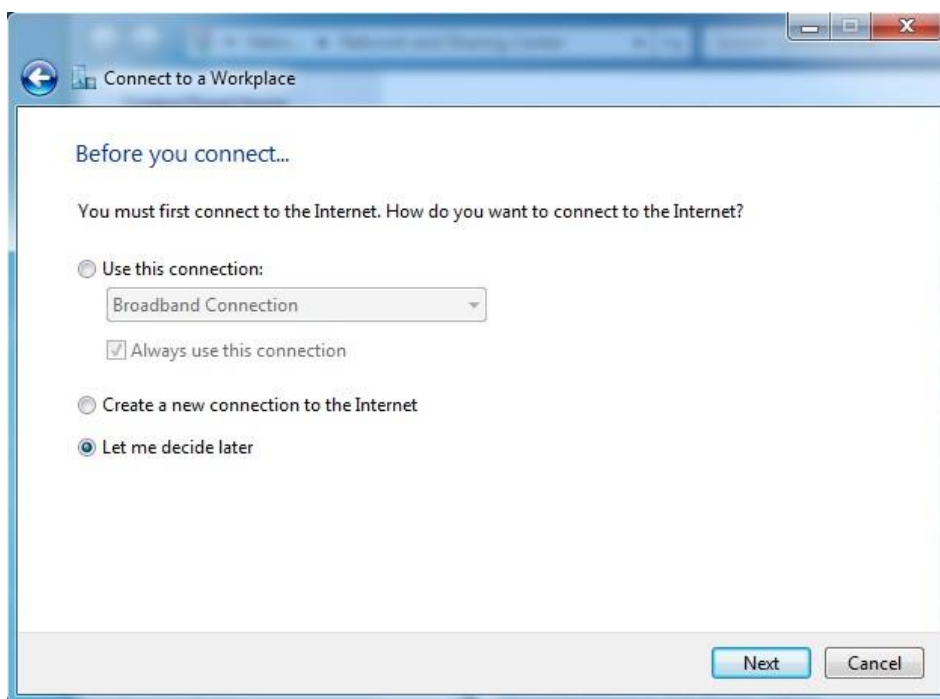

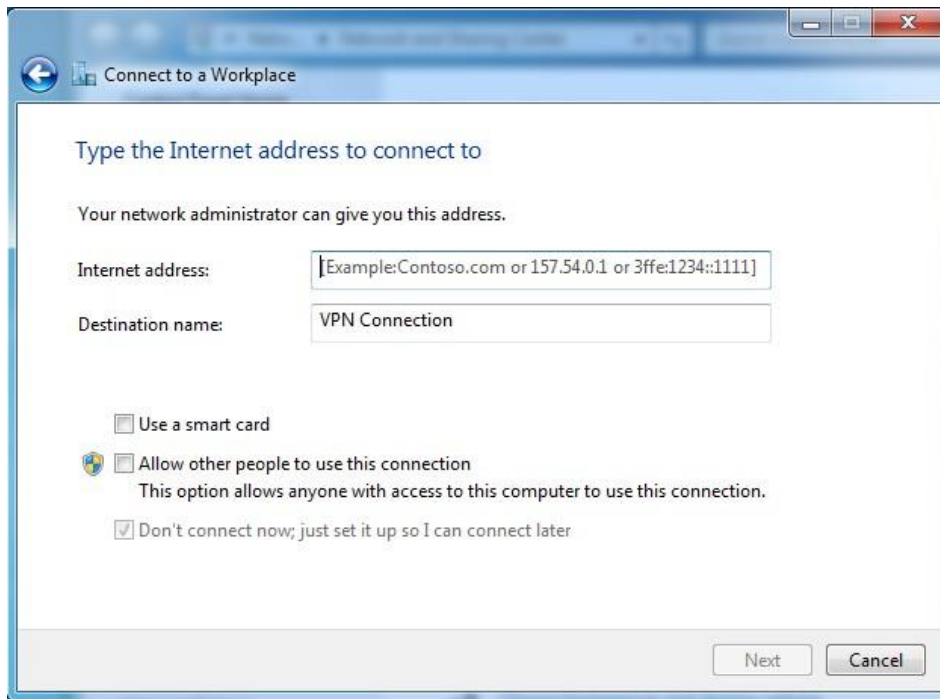

4 Type the public WAN IP of the PPTP server (such as: **183.37.211.8** here) in the **Internet address** field, and click **Next**.

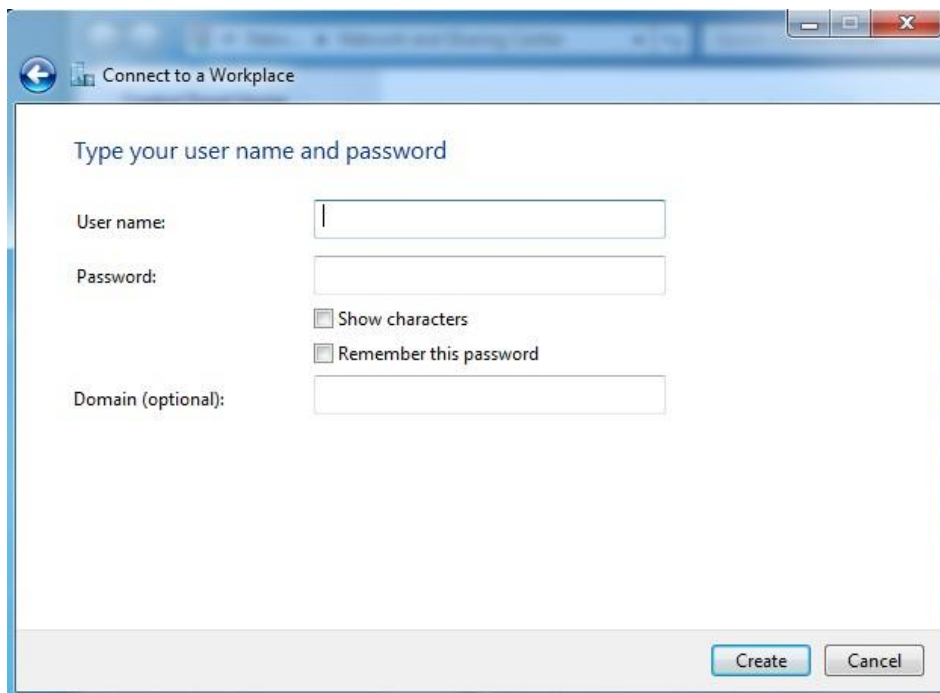

- 5 Type the user name and password of the PPTP server, click **Create**, and then click **Close**.

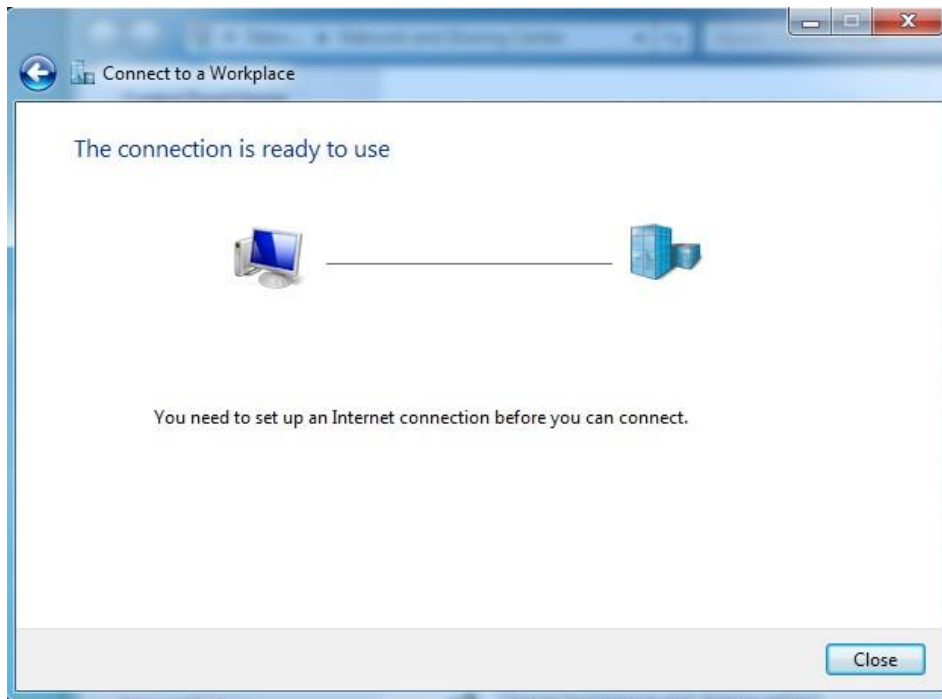



6. Click the icon  on the bottom right corner of your desktop, and then click **VPN Connection**.

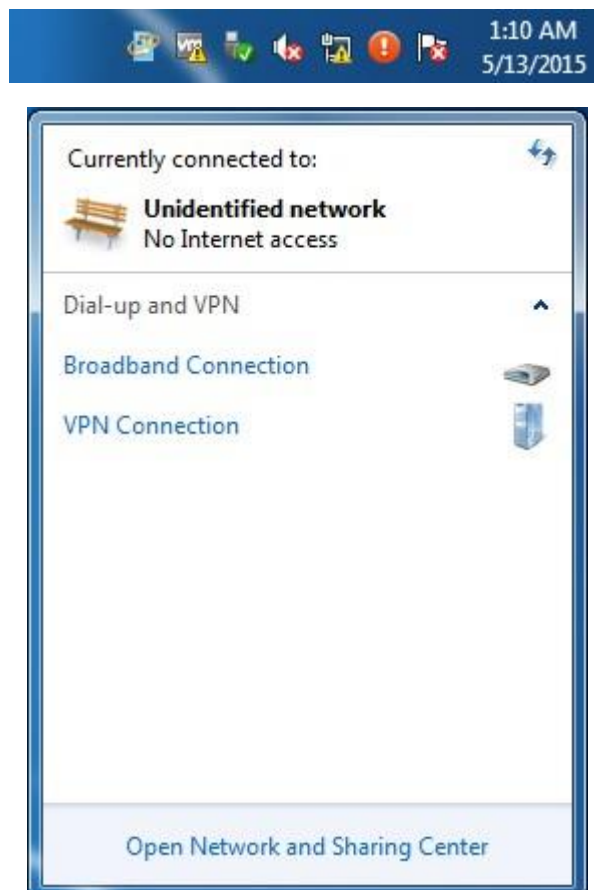

7. Type the user name and password of the PPTP server in the pop-up window again, and click **Connect**.



When the VPN Connection displays **Connected**, it indicates that you access the PPTP server successfully.



To access the FTP server:

Launch a web browser, type the address of the FTP server (**ftp://LAN IP address: port number**, such as **ftp://192.168.0.154:21**) in the address bar, and tap **Enter** on the keyboard.



Then you can visit the resources on the FTP server.

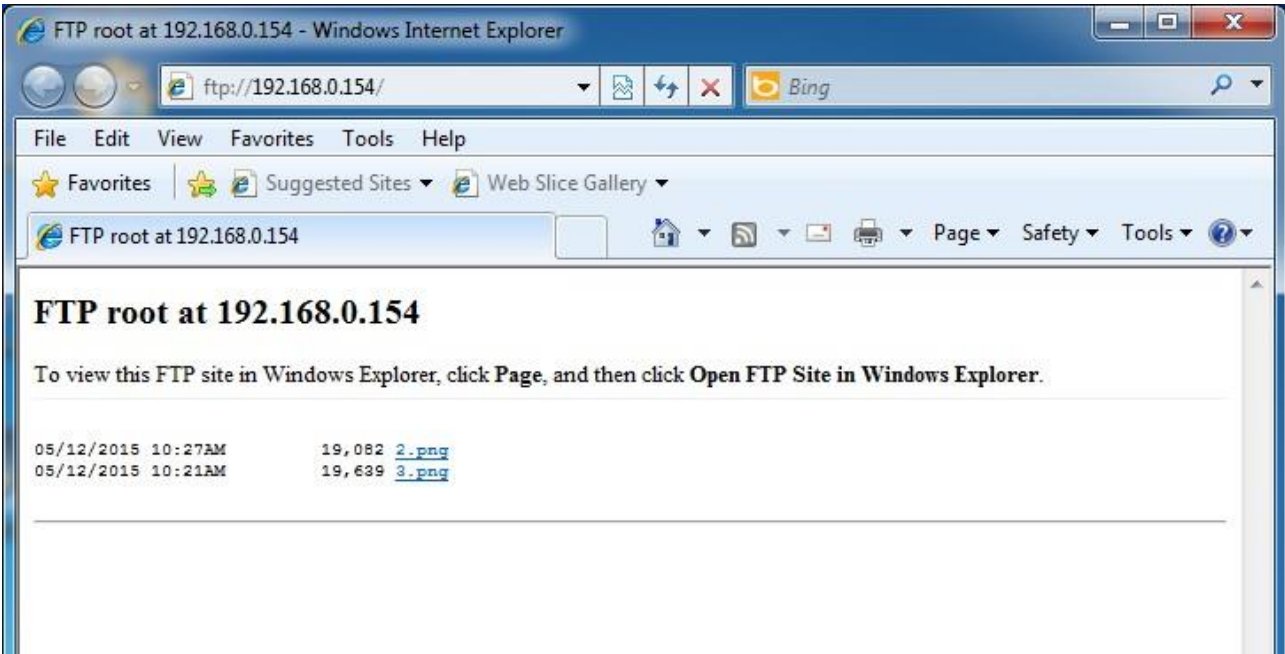

PPTP/L2TP Client

When acts as a PPTP/L2TP client, the Router helps you to establish a secure communication between the attached devices and the PPTP/L2TP server provided by individual or Internet Service Provider.

Then you don't need establish a VPN connection on your computer.

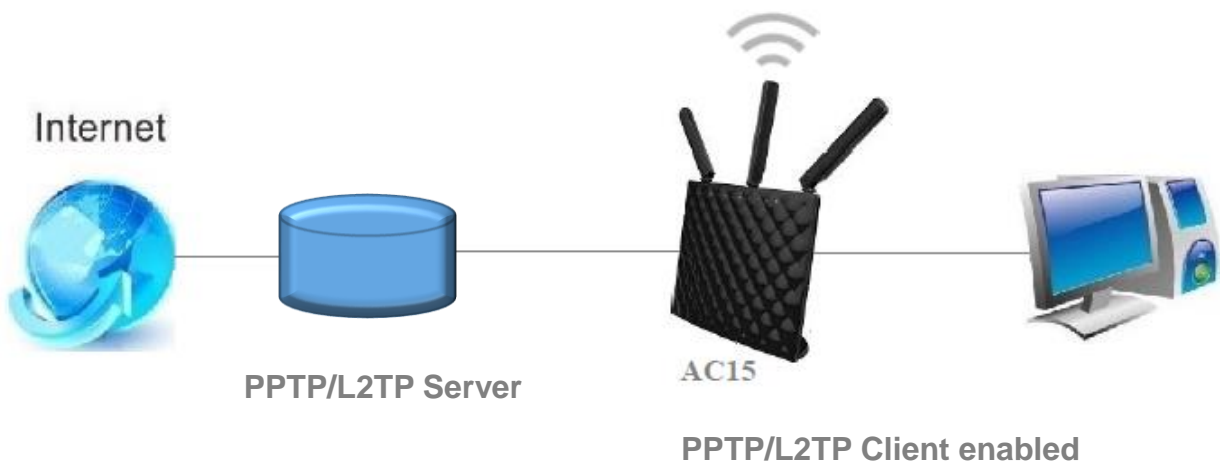

To set up PPTP Client:

Log in to the Router's User Interface, and click **VPN > PPTP/L2TP Client**.

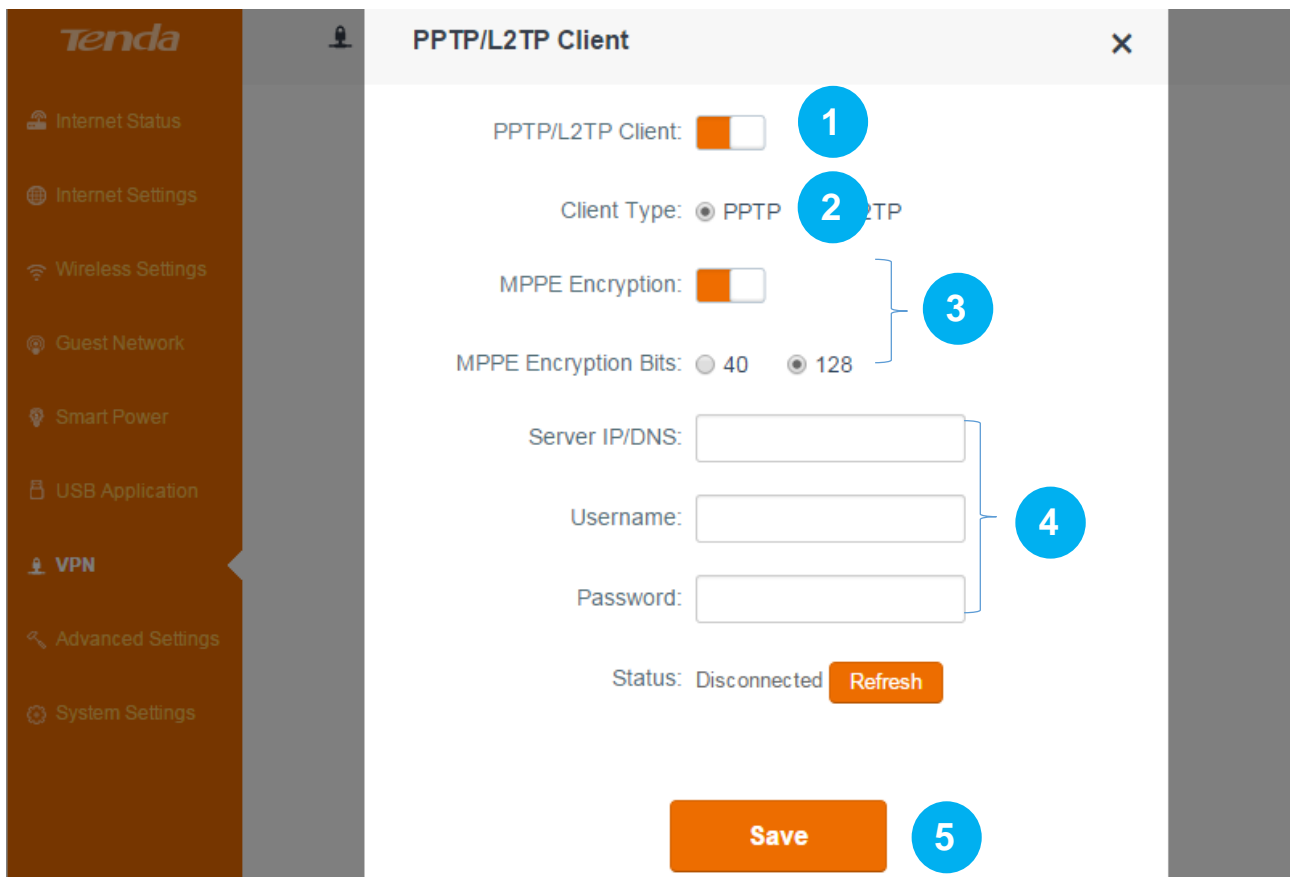

- 1 Click **PPTP/L2TP Client** button to enable the feature.
- 2 Select **PPTP**.
- 3 Click to enable MPPE Encryption, and select an encryption bits, **40** or **128** according to your needs.
- 4 Type the server IP/DNS, username, and password of the PPTP server.
- 5 Click **Save**.

To set up L2TP Client:

Log in to the Router's User Interface, and click **VPN > PPTP/L2TP Client**.

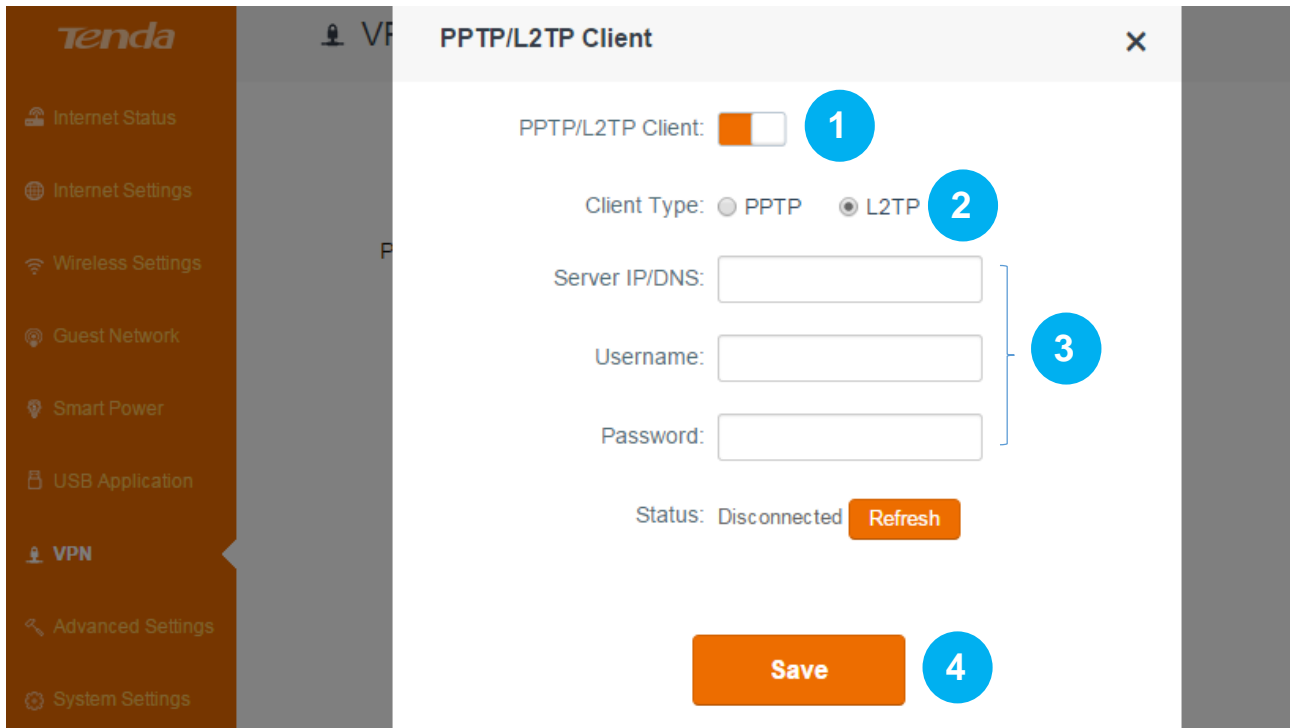

- 1 Click **PPTP/L2TP Client** button to enable the feature.
- 2 Select **L2TP**.
- 3 Type the Server IP/DNS, username, and password of the L2TP server.
- 4 Click **Save**.

8 Advanced Settings

This section will explain more features such as: Parental Control, Bandwidth Control, Smart LED, and etc.

Click the following icons (shortcut) to go to the corresponding features.

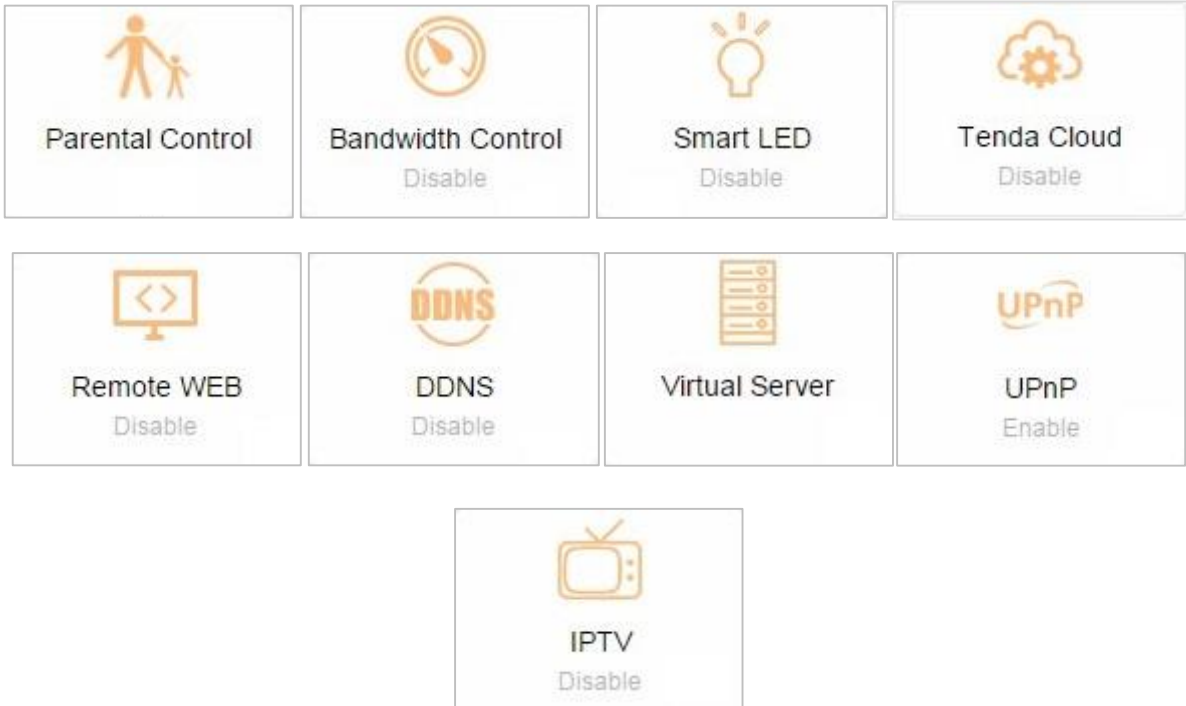

Parental Controls

With Parental Controls, you can only allow your teenager to visit some specified sites and restrict access by time.

To control access to the Internet:

Log in to the Router's User Interface, and click **Advanced Settings > Parental Controls**.

- 1 Click the selected device's **Action** button on the right.

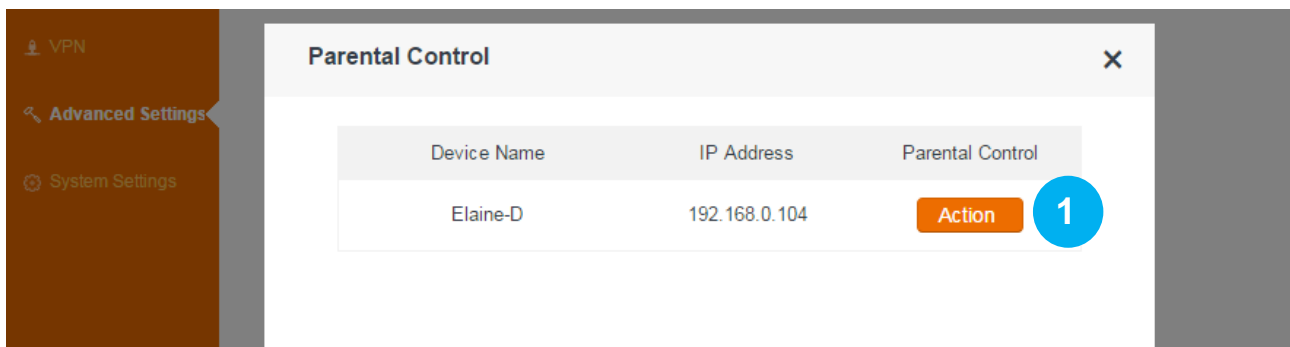

- 2 You can customize a device name for easy recognition, and click **Complete**.

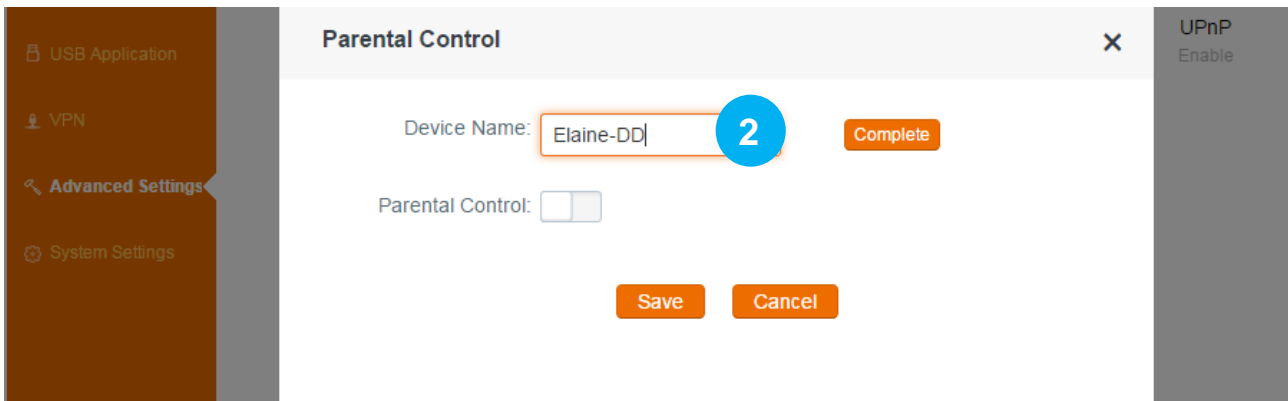

3 Click **Parental Control** button to enable the feature.

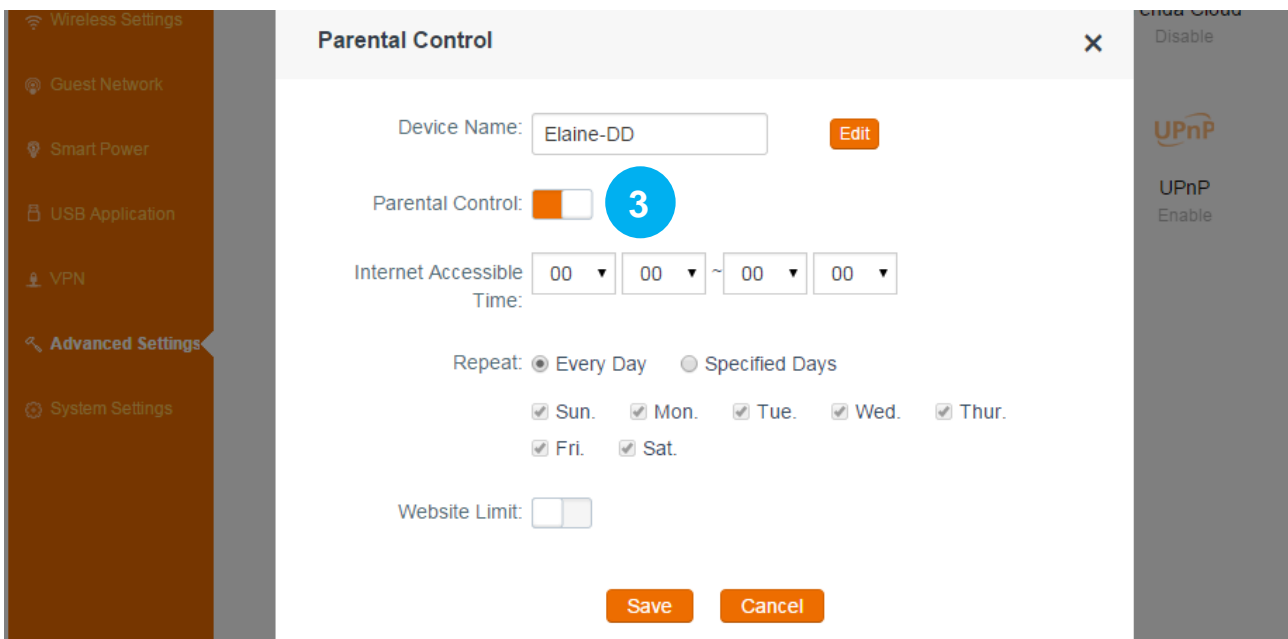

4 Select the time you allow your teenager to access the Internet, for example: 07:00pm~10:00pm.

5 Select **Specified Days**.

6 Select the days you apply the rule, for example: Monday to Friday.

7 Click **Save**.

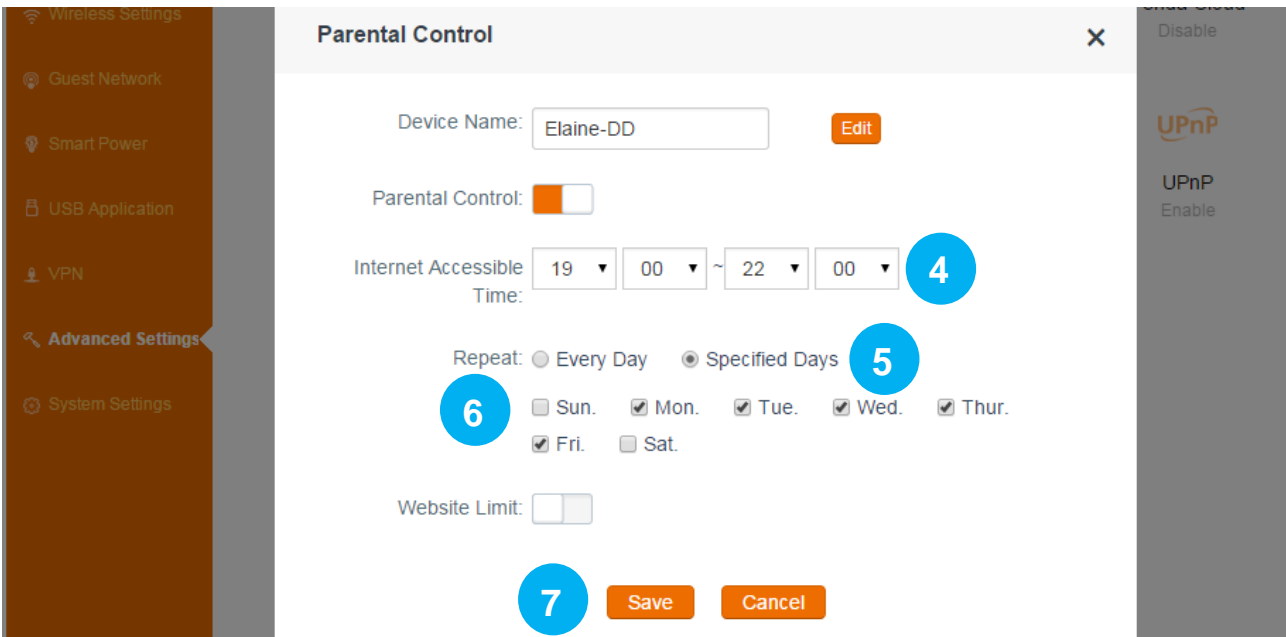

To use key words to allow Internet sites

To block your teenager from visiting some inappropriate and dangerous sites, you can only allow them to visit the Internet sites you specify.

- 1 Click **Website Limit** button to enable the feature.
- 2 Type the key words of the websites you want to allow to visit in the box.
- 3 Click **Save**.

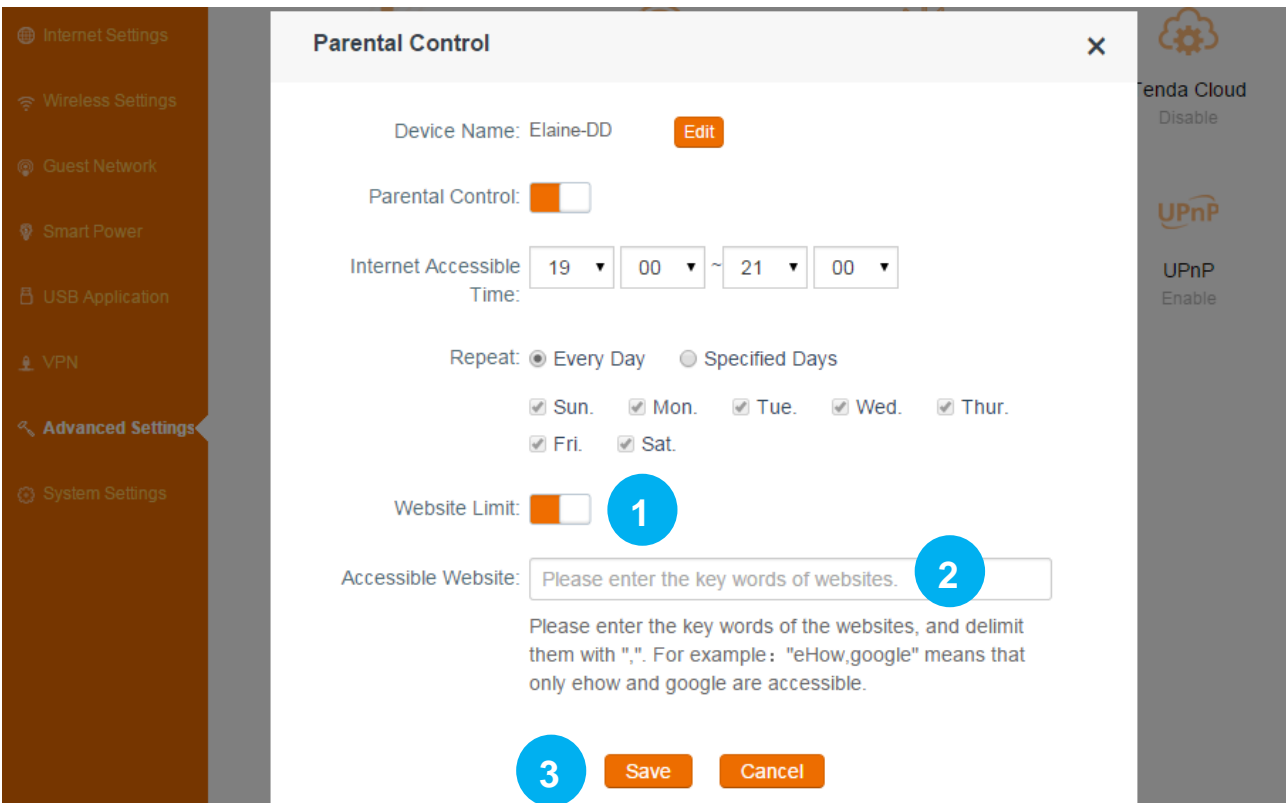

Bandwidth Control

Bandwidth Control improves network performance by specifying the download/upload speed for connected clients. The example below is for you to consult to configure Bandwidth Control based on your own demands.

Example

Always several devices share 4M broadband service in your home. You recently have to watch lots of news videos to prepare for a special program but only to find it's hard to go through the videos smoothly. Your notebook starves for more bandwidths.



In this case, you can choose to configure a download bandwidth rule in Bandwidth Control to allocate sufficient bandwidth for your notebook. Upload bandwidth rule is not always used unless you have to upload lots of files and videos.

Configuration

Log in to the Router's User Interface, and click **Advanced Settings > Bandwidth Control**.

- ① Select a download speed for your notebook.
- ② Click **Save**.

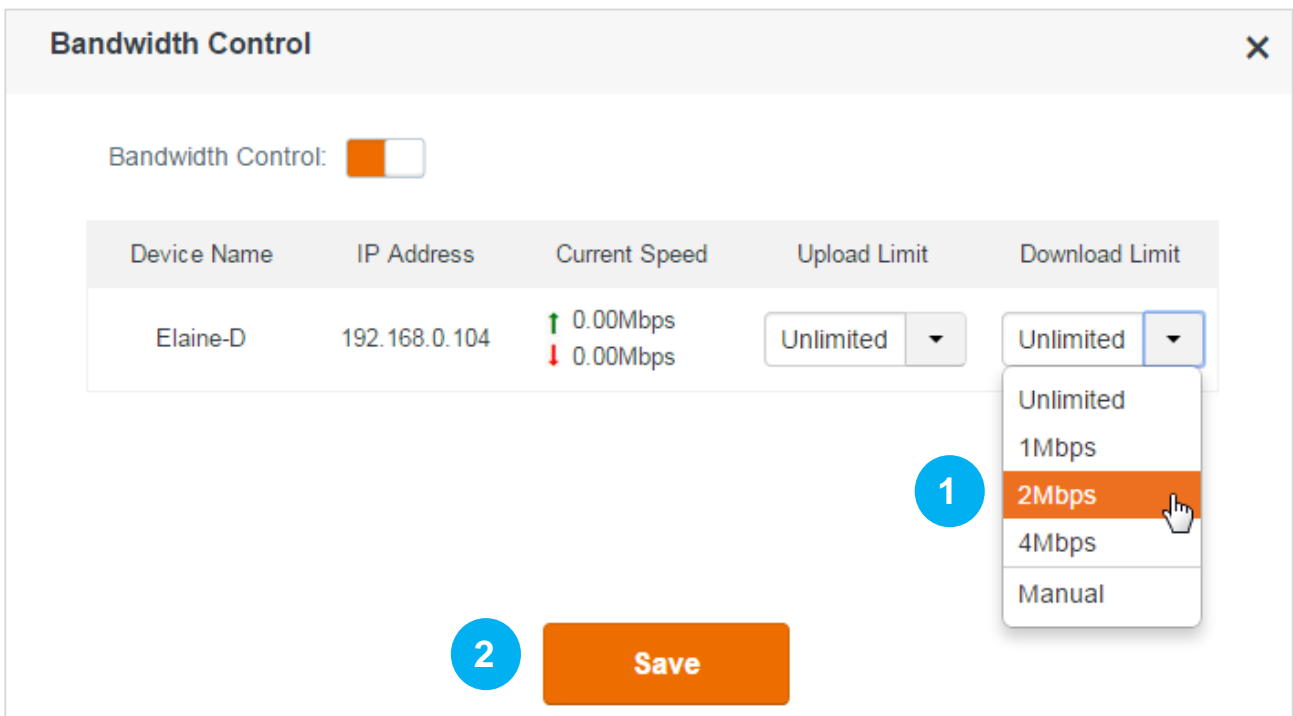

Smart LED

Smart LED allows you to turn ON/OFF LED indicators when the Router is working for power saving, or other purpose.

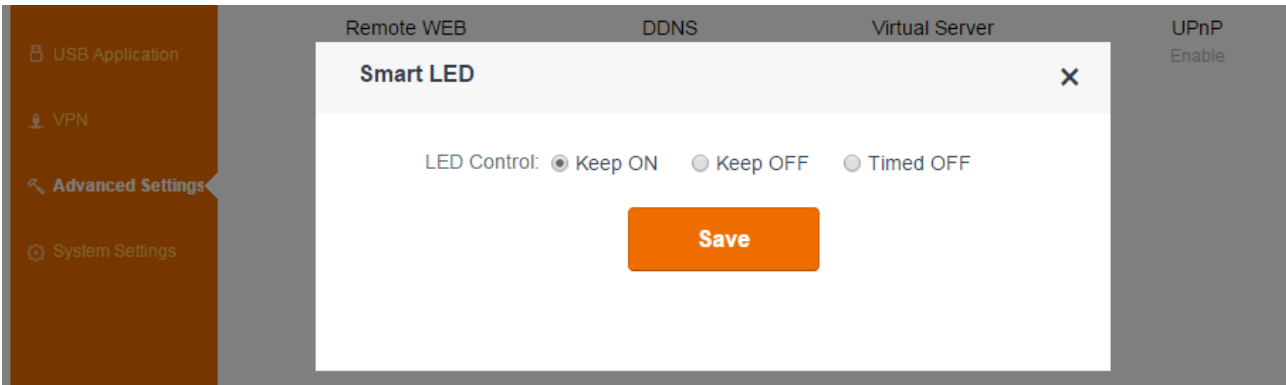

To specify the settings of Smart LED:

Log in to the Router's User Interface, and click **Advanced Settings > Smart LED**.

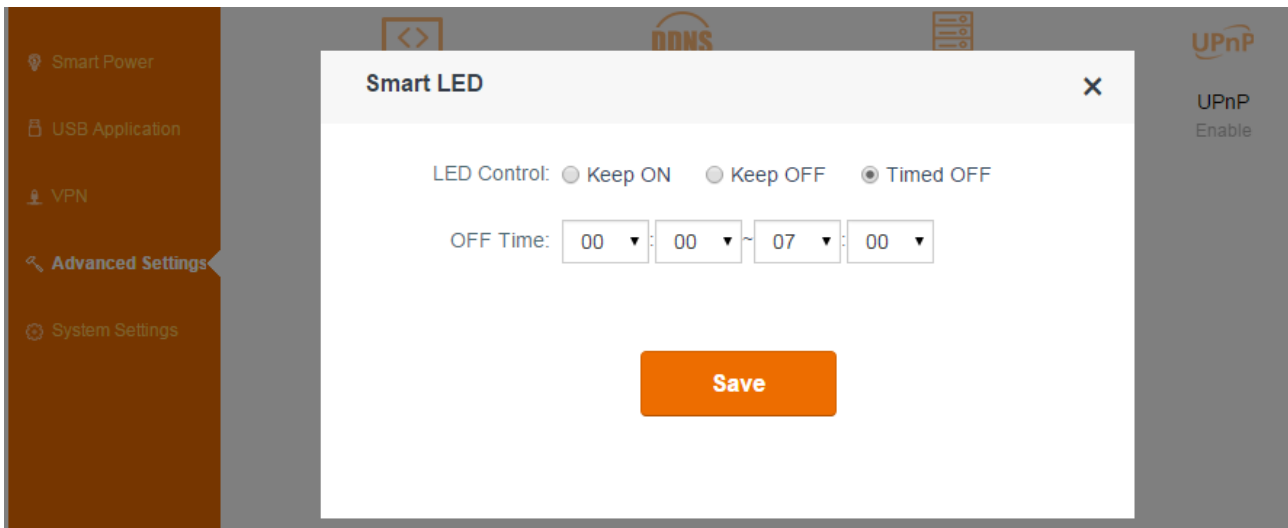

Keep on: The indicators keep on when it works.

Keep OFF: The indicators keep off when it works.

Timed OFF: You can specify the indicators' off time.

- ① Check an option according to your needs.
- ② Click **Save**.

Tenda Cloud

Tenda Cloud allows you to manage your Router anywhere and anytime via your smart phone, iPad, and etc. with the Tenda App. To manage the Router remotely using the Tenda App, you need register a Tenda Cloud account, and attach the Router to the account.

To download the Tenda App:

Log in to the Router's User Interface, and click **Advanced Settings > Tenda Cloud**.

- ① Click the **Tenda Cloud** button to enable the feature.
- ② Scan the QR code on the page to download the Tenda App using your smart devices.

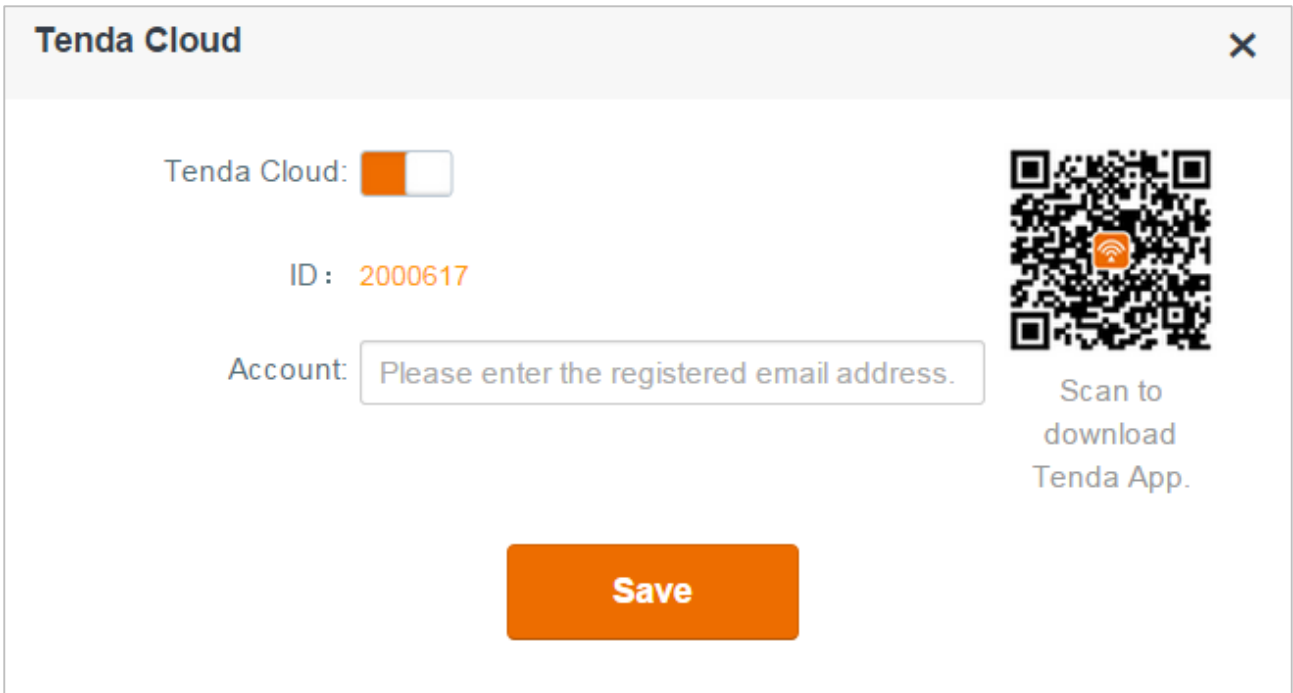

To register an account:

Use the Tenda App to register an account. Please download the User Guide of the **Tenda WiFi** (the name of the app) from <http://www.tendacn.com/> for details.

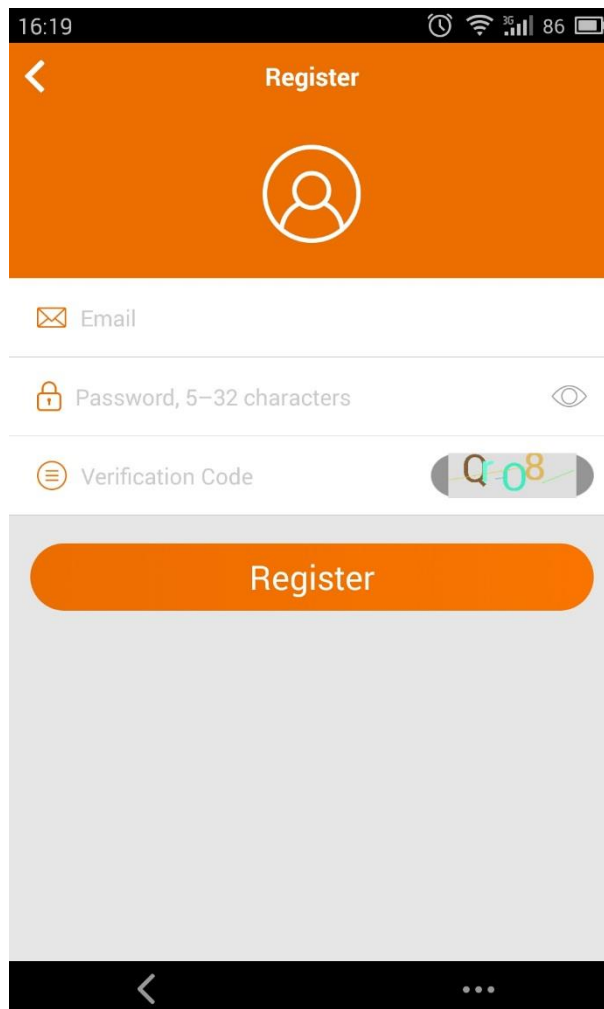

To attach the Router to an account:

There are two methods to attach the Router to a Tenda Cloud account.

Method 1:

Log in to the Router's User Interface, and click **Advanced Settings > Tenda Cloud**.

- 1 Click the **Tenda Cloud** button to enable the feature.

Tenda Cloud: 1

ID: 2000617

Account: 2

3 Save

Scan to download Tenda App.

- 2 Type the Tenda Cloud account you registered to the **Account** box.
- 3 Click **Save**.

Method 2:

- 1 Connect to the Router's WiFi using your smart device (smart phone, and etc.).
- 2 Open **Tenda WiFi**.
- 3 Log in to Tenda Cloud account.
- 4 Click **Add** button.

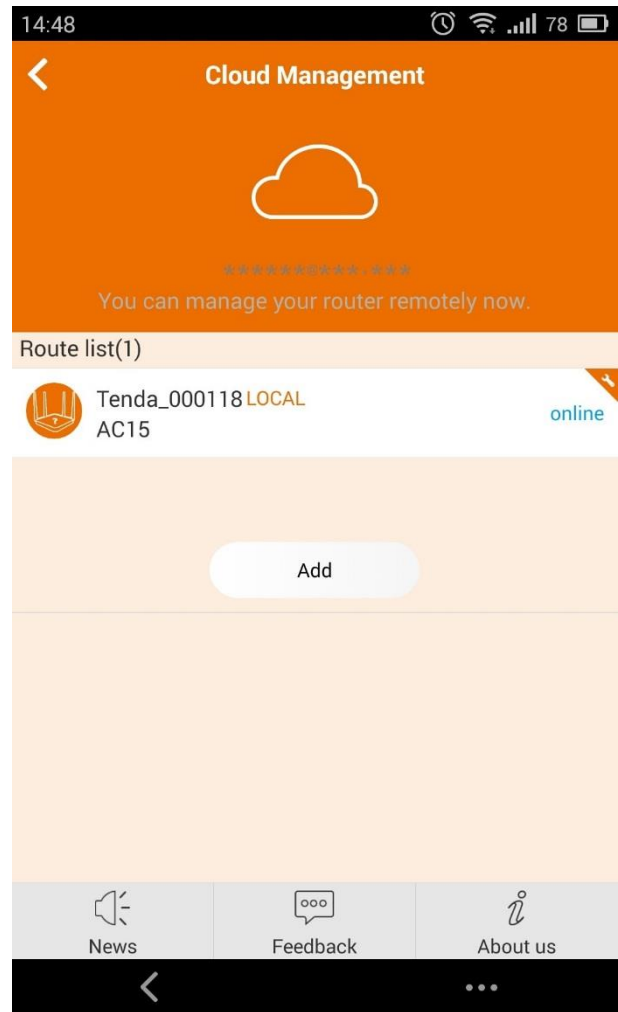
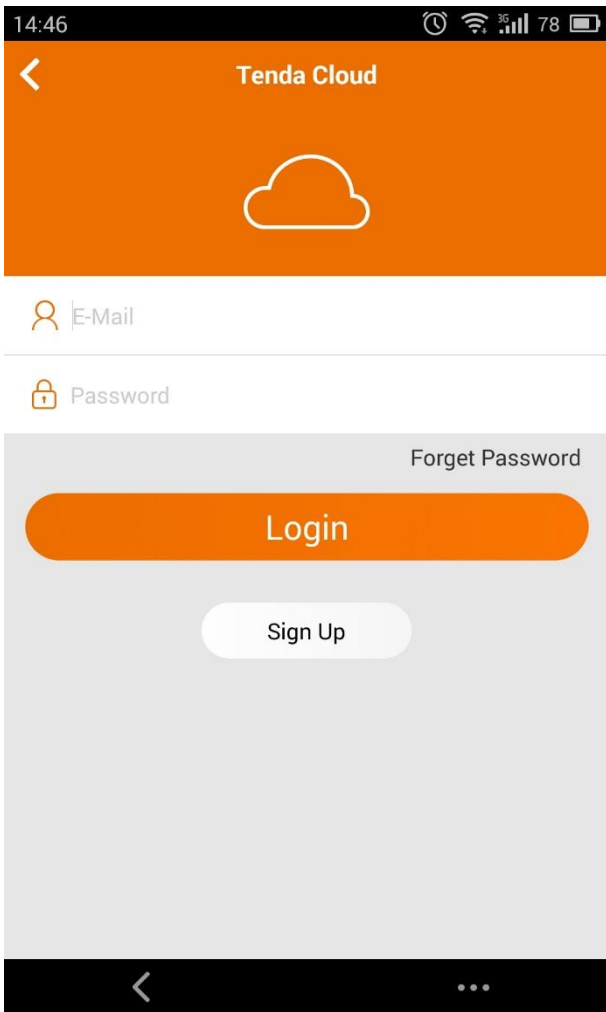

- 5 Type the Router's login password, and click **OK**.

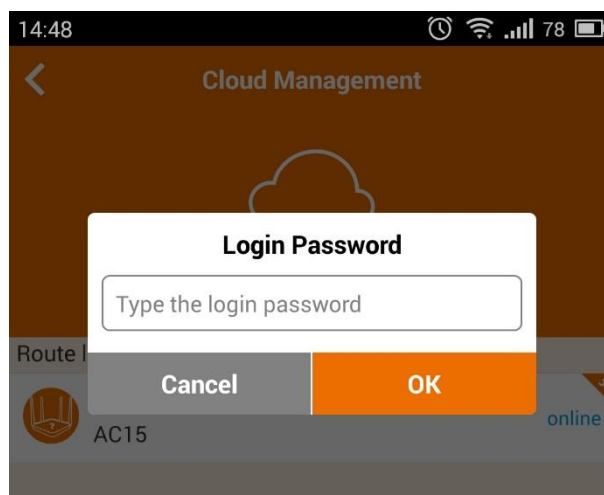

 **Tips**

The **ID** is the unique number of the Router for Cloud management. The **Tenda WiFi** uses the **ID** find and manage the Router remotely. It is not editable, and you don't need to edit it.

Remote WEB

This section can help you to manage your Router remotely.

Example

You want to manage your home network when you are in the company. Assume that the WAN IP address of your computer in the company is “202.165.100.105”, and it is a **public IP** address (Only when the IP is a public IP, can this Router can be managed remotely). And your Router at home is working properly, the WAN IP is “190.136.2.5”, and it’s a **public IP** address as well.

Now configure the Router to provide remote web management.

Configuration

Log in to the Router’s User Interface, and click **Advanced Settings > Remote WEB**.

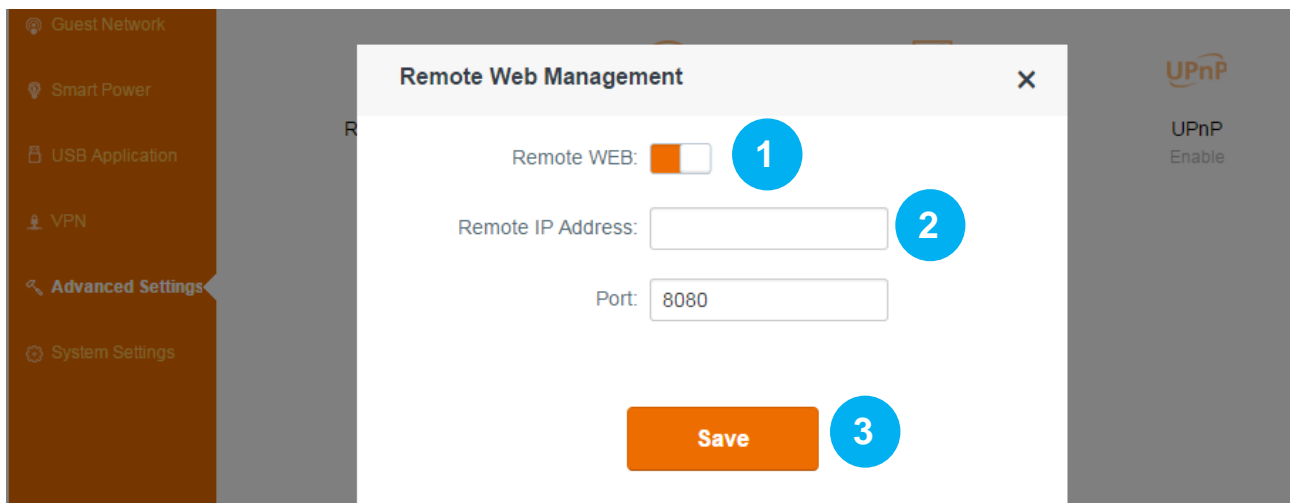

- ① Click **Remote WEB** button to enable the feature.
- ② Type the remote IP Address in the box: 202.165.100.105 here.
- ③ Click **Save**.

Verification

When you’re in the company, you can use your computer to access your Router’s User Interface by entering “<http://190.136.2.5:8080>” in a browser.

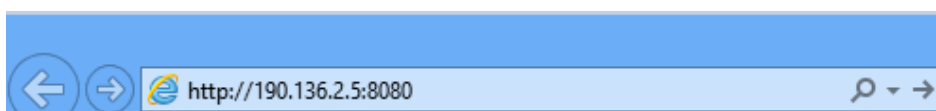

Remote Web Management + DDNS

However, in the example above, the WAN IP of the Router in your home may not always be static. You can give the WAN IP a static host name via DDNS to maintain the connection between your

Router and the computer in your company. Go to “[DDNS](#)” for details to configure a username, password, and domain name.

Assume you signed up an account *tenda01.3322.org* from *dyndns.org*, the username is *tenda01*, and the password is *1234567890*.

After you bind a static hostname to the WAN IP, when you’re in the company, you can also access the Router’s User Interface by entering “<http://tenda01.3322.org:8080>” in a browser of your computer in the company.

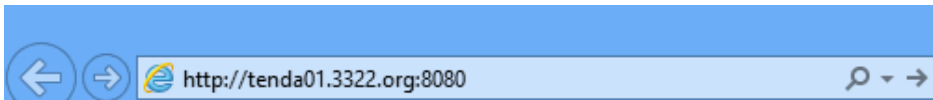

DDNS

DDNS (Dynamic Domain Name Server) allows a dynamic public IP address of one service to be associated with a static host name, so that anyone anywhere on the Internet can visit the host and share the service. Thus, uninterrupted access to services whose numeric IPs may change is maintained. After DDNS is enabled, using URL “*hostname.no-ip.com*”, “*hostname.3322.org*” or “*hostname.dyndns.org*” to access the host.

For your WAN IP (public IP) may change, DDNS can help you use a static host name to maintain the connection.

Follow steps below to apply for the domain name *tenda.dyndns.org*, username *tenda* and password *12345678*.

Configuration

Log in to the Router’s User Interface, and click **Advanced Settings > DDNS**.

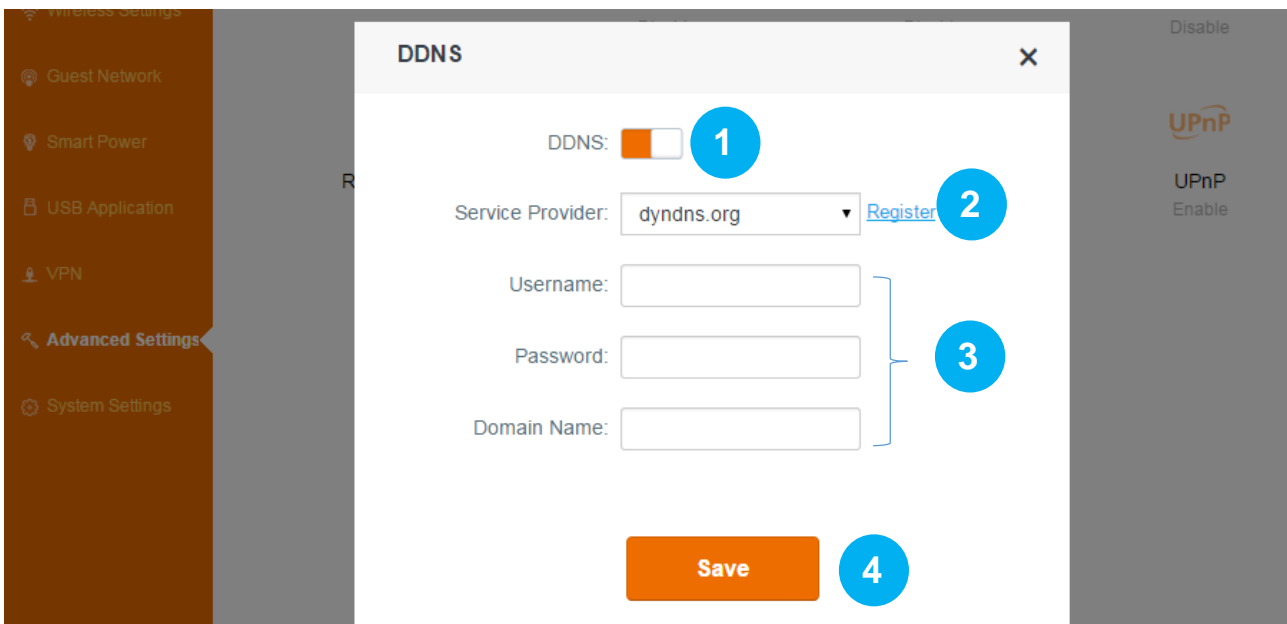

- 1 Click **DDNS** button to enable the feature.
- 2 Select a service provider, **dyndns.org** here.
- 3 Type the username, password and domain name in the corresponding boxes: *tenda*, *12345678* and *tenda.dyndns.org*.
- 4 Click **Save**.

Verification



After the configuration above, your friend can access your ftp server via <ftp://tenda.dyndns.org> instead of <ftp://183.38.7.216:21> to download the giant file.

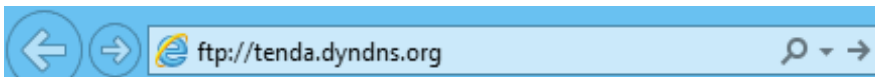

Virtual Server

Virtual Server helps you to direct network traffic from the Internet to a specific port or a specific range of ports to a device or number of devices on your local network. If you have a server in your home network, you can allow certain types of incoming traffic to reach the server. For example, you might want to make a local web server, or FTP server visible and available to the Internet.

Example

You have a FTP server (IP:192.168.0.150) in your home network. When work in the company, you

want to visit the resources on the FTP server.



Configuration

Log in to the Router's User Interface, and click **Advanced Settings > Virtual Server**.

The screenshot shows the 'Virtual Server' configuration window in the router's UI. The window has a table with the following structure:

Internal IP	Intranet Port	Extranet Port	Action
<input type="text"/>	21	<input type="text"/>	<input type="button" value="Add"/>

Numbered callouts indicate the configuration steps: 1 points to the Internal IP field, 2 points to the Intranet Port dropdown menu, 3 points to the Add button, and 4 points to the Save button at the bottom of the window.

- ① Type the IP address of the computer that established the FTP server (192.168.0.105 here).
- ② Select the FTP server default port (21), the extranet port will be auto-filled.

3 Click **Add**.

4 Click **Save**.

Note

1. The WAN IP of your computer in your company and the Router at home MUST be PUBLIC IP address.
2. If the public WAN IP of the Router is dynamic, you can use the [DDNS](#) feature to solve the problem.

UPnP

When UPnP is enabled on your Router, a network device possessing a specific purpose, such as a printer, can be identified and used automatically by another computer or device in your network.

Log in to the Router's User Interface, and click **Advanced Settings > UPnP**.

It is advisable to keep the default settings.

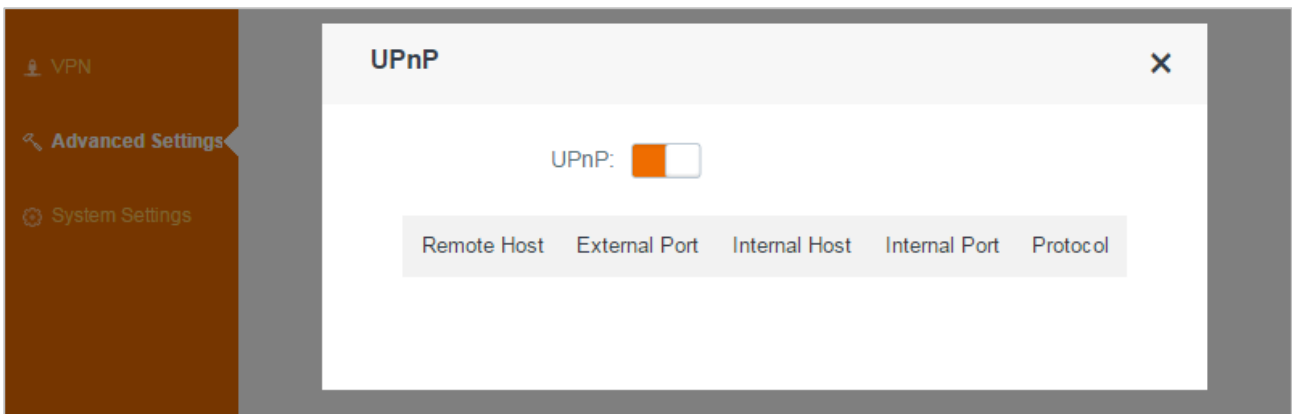

IPTV

The wireless Router supports IPTV feature.

Log in to the Router's User Interface, and click **Advanced Settings > IPTV**.

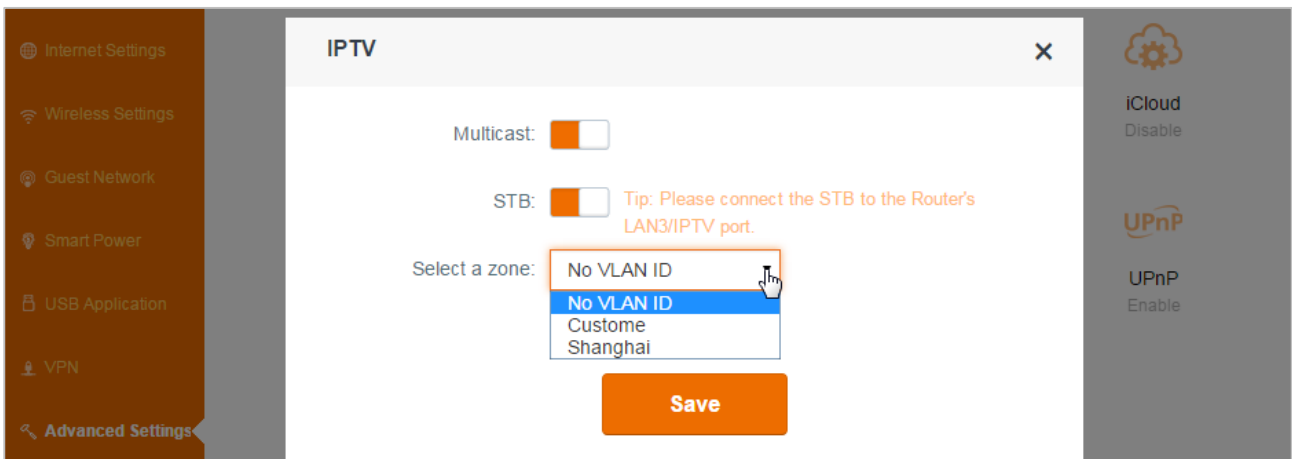

- ① **Multicast:** If the Multicast is enabled, you can get the multicast videos resources from the Internet. It is recommended to enable it.
- ② **STB:** If you has a set-top box at home, and also order IPTV service form your Internet Service Provider. Enable the STB feature, and connect your set-top box to the (LAN) 3 port of your Router.
- ③ **Select a zone:** Consult Internet Service Provider for specific information of this part.
- ④ Click **Save**.

Then you can enjoy online video on your smart TV.



Tips

When the IPTV feature is enabled, the Wireless Repeating is not available.

9 Administration

This section describes how to administer and maintain your Router and home network.

Click the following icons to go to the corresponding features.

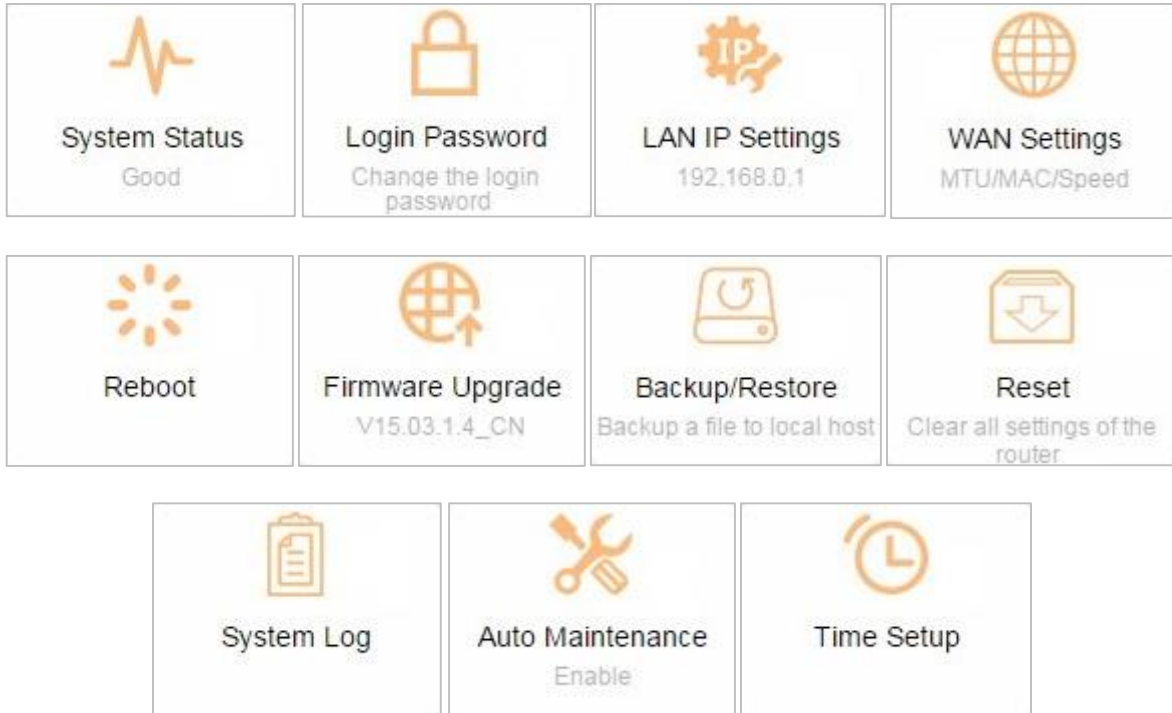

System Status

This part allows you to view this Router's current network status: basic info, WAN status, LAN Status, and WiFi Status.

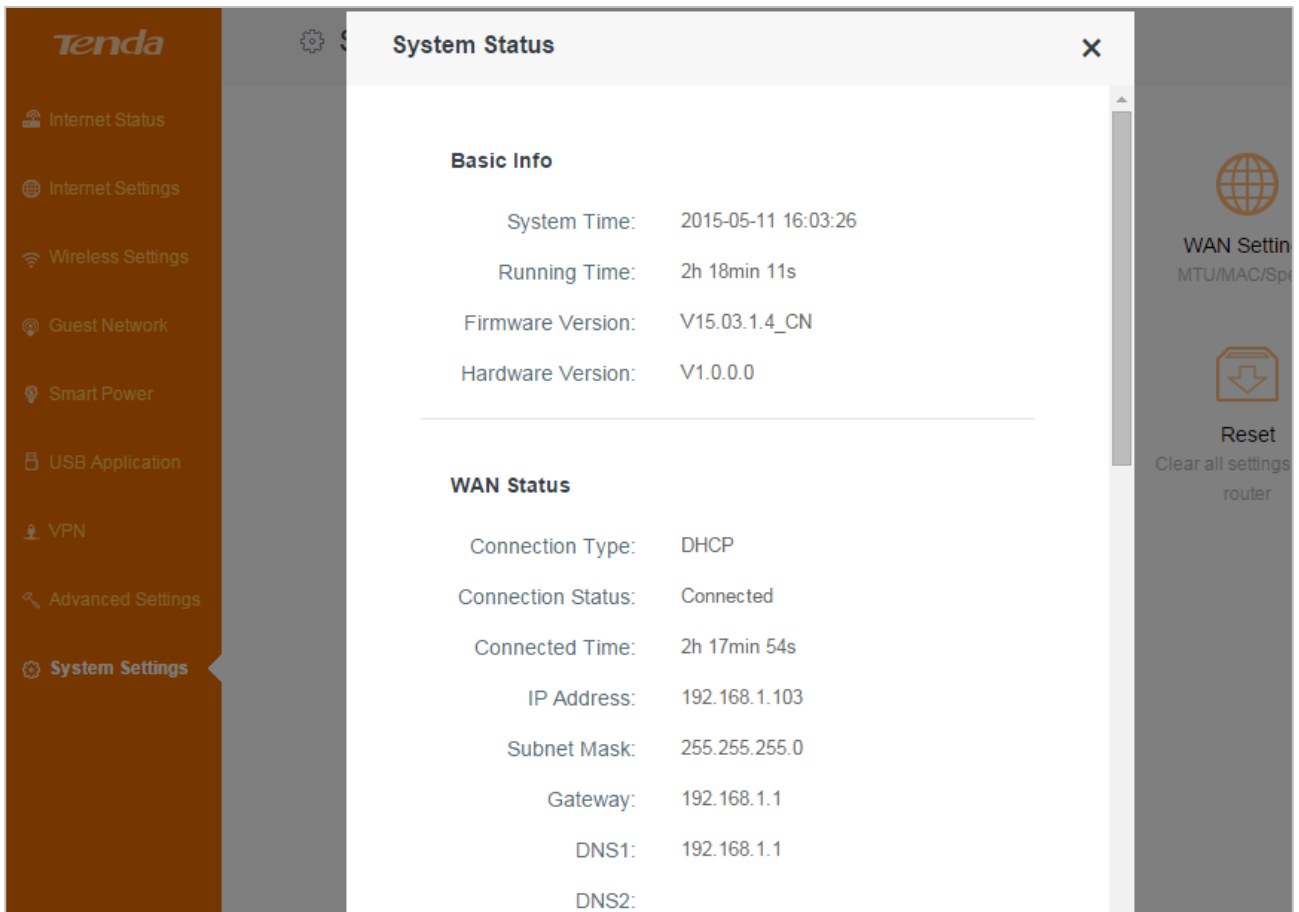

Login Password

To secure your network, you'd better change the login password termly.

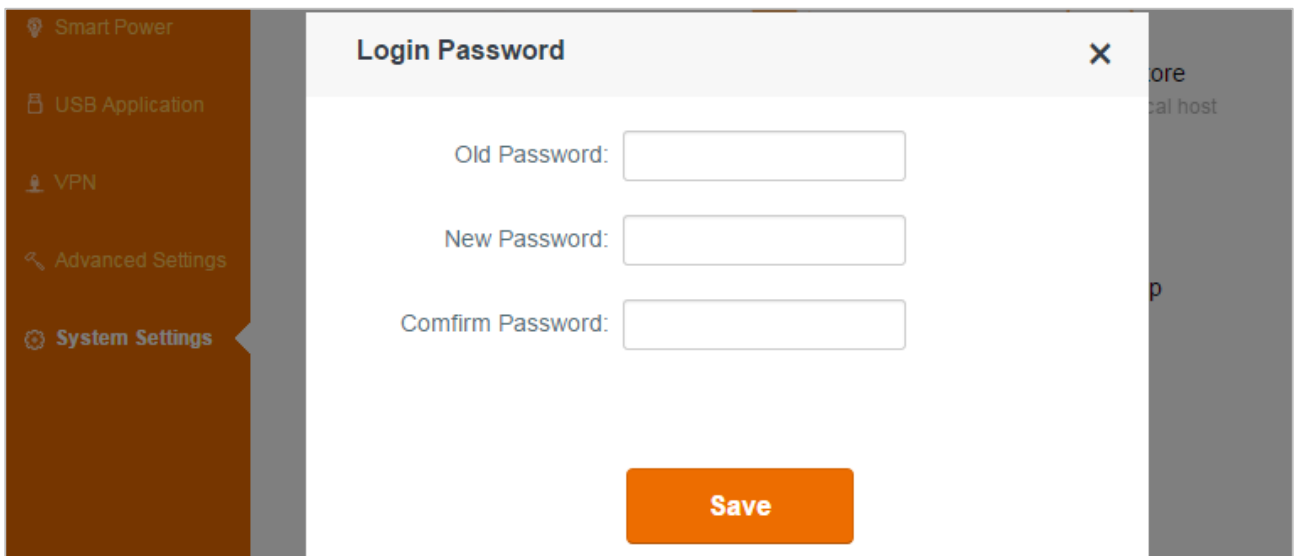

To change the login password:

- ① Type the old password.
- ② Customize a new login password.
- ③ Type the new password again, and click **Save**.



Tips

1. There is no login password by default. The old login password is that you set up in quick setup wizard.

Wireless Settings

America

WiFi Name

Please enter a WiFi password

Set up the administrator(login) password as the same as the WiFi password

Please enter a login password

Next

2. After successful configuration, you need log in to the User Interface again with the new login password.

Tenda

English

Please enter the login password.

Login

Forgot password? ▾

LAN IP Settings

Here you can change the LAN IP address, enable/disable DHCP server, or specify the LAN IP address pool and the lease time.

Log in to the Router's User Interface, and click **Administration > LAN IP Settings**.

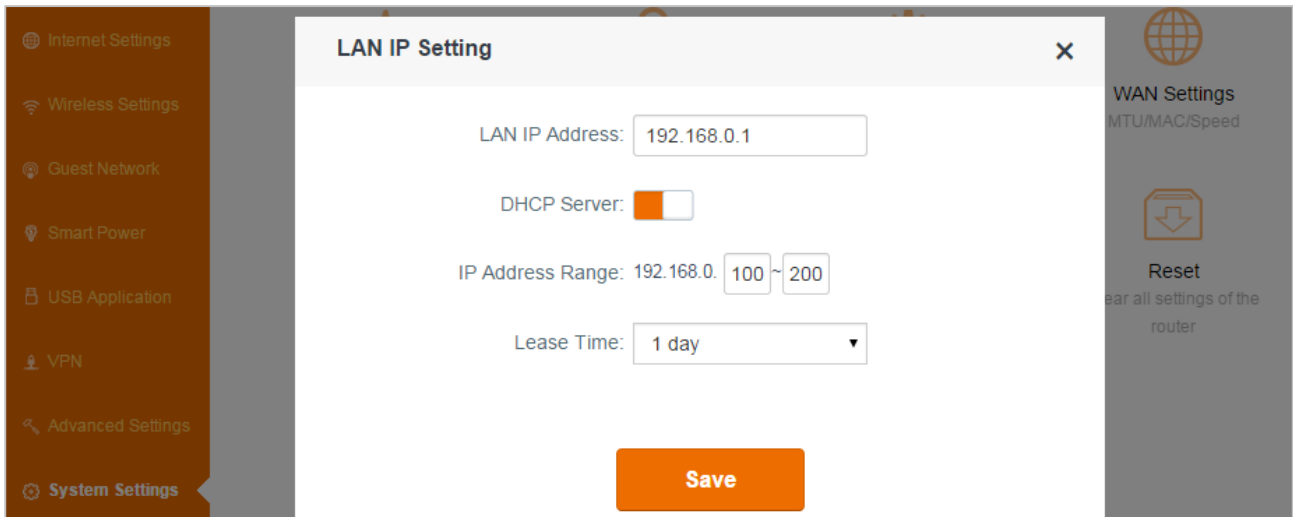

LAN IP

Here you can customize a LAN IP for your Router.

When you use the wireless repeating feature, you might need to change the LAN IP address in case there is an IP conflict between the LAN IP of the Router and base station.

DHCP Server

DHCP server can automatically assign the broadband service information (IP Address, Subnet Mask, Gateway and DNS Server Address) to the computer or smartphone, or other devices in your network wirelessly or via Ethernet cables. Do not disable this function until you want to configure the IP address manually for each device in your network by yourself.



Tips

The DHCP Server option will be unchecked automatically when you use the Universal Repeater (Client + AP) feature.

IP Address Range

When the DHCP server is enabled, the Router will assign IP addresses to the attached devices. IP address range is the range of these IP addresses.

Lease Time

Select the lease time of the IP assigned automatically, say **1 day**. When the lease time is used up, the IP will renew automatically. So you don't need to reset it manually.

WAN Settings

Log in to the Router's User Interface, and click **Administration > WAN Settings**.

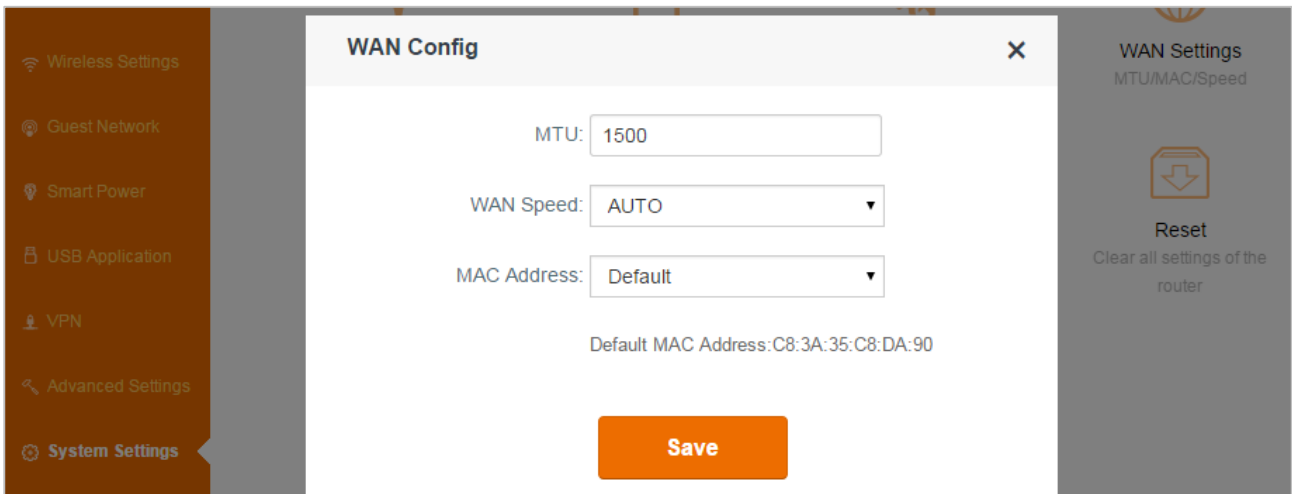

MTU

Do not change the default value unless necessary. If you are unable to open some website, to receive or send emails, etc., try to minimize the MTU value until your network returns to normal.

MTU	Applications
1500	Typical for connections that do not use PPPoE or VPN
1492	Used in PPPoE environments.
1472	Maximum size to use for ping. (Larger packets are fragmented.)
1468	Used in some DHCP environments.
1436	Used in PPTP environments or with VPN.

Tips

An incorrect MTU setting can cause Internet communication problems. You might not be able to access certain websites, secure login pages, or FTP or POP servers.

WAN Speed

By default, the WAN rate is **Auto**. Generally, it is not advisable to change the default value. When the cable length between your Router and the remote device (modem, Router, etc.) is relatively long, you can set WAN rate to 10M or 100M to enhance transmission rate.

The screenshot shows the 'WAN Config' window with the following fields:

- MTU: 1500
- WAN Speed: AUTO
- MAC Address: A dropdown menu is open, showing options: AUTO (highlighted), 10M FDX, 10M HDX, 100M FDX, and 100M HDX. Below the menu, it says 'Local Host MAC Address: C6.9C.DC.60:54:69'.

A 'Save' button is located at the bottom center.

MAC Address

Some ISPs will bind your broadband account info and a specified MAC address of your computer together. If you can only access the Internet with a specified computer without a Router, you can try cloning MAC address for normal Internet access. By default, it clones the local host's MAC address.

The screenshot shows the 'WAN Config' window with the following fields:

- MTU: 1500
- WAN Speed: AUTO
- MAC Address: A dropdown menu is open, showing options: Clone MAC Address (highlighted), Default, Clone MAC Address, and Manual. Below the menu, it says ':60:54:69'.

A 'Save' button is located at the bottom center.

If you want to clone other MAC address, or change the Router's MAC address, select **Manual** and type the Mac address in the following box.

The screenshot shows the 'WAN Config' window with the following settings:

- MTU: 1500
- WAN Speed: AUTO
- MAC Address: Manual
- Format: XX:XX:XX:XX:XX:XX

A 'Save' button is located at the bottom of the window.

Reboot

Rebooting the Router will activate any modified settings on the Router. When the parameters you set cannot take effect or the Router cannot be used normally, please try rebooting your Router to solve these problems. Note that when the Router is rebooting, do not power off any relevant devices (Router, computer, etc.).

Log in to the Router's User Interface, and click **Administration > Reboot**.

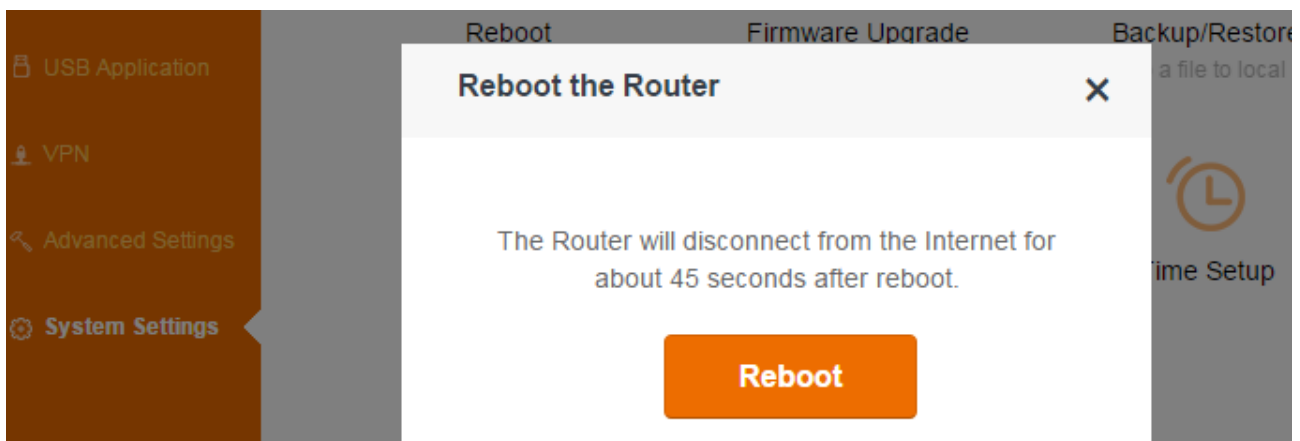

Firmware Upgrade

Tenda official website offers the latest software version for your Router. Follow steps below to upgrade the device if you want. However, when the Router is in normal operation, it is not advisable to upgrade it.

Local Upgrade

Log in to the Router's User Interface, and click **Administration > Firmware Upgrade**.

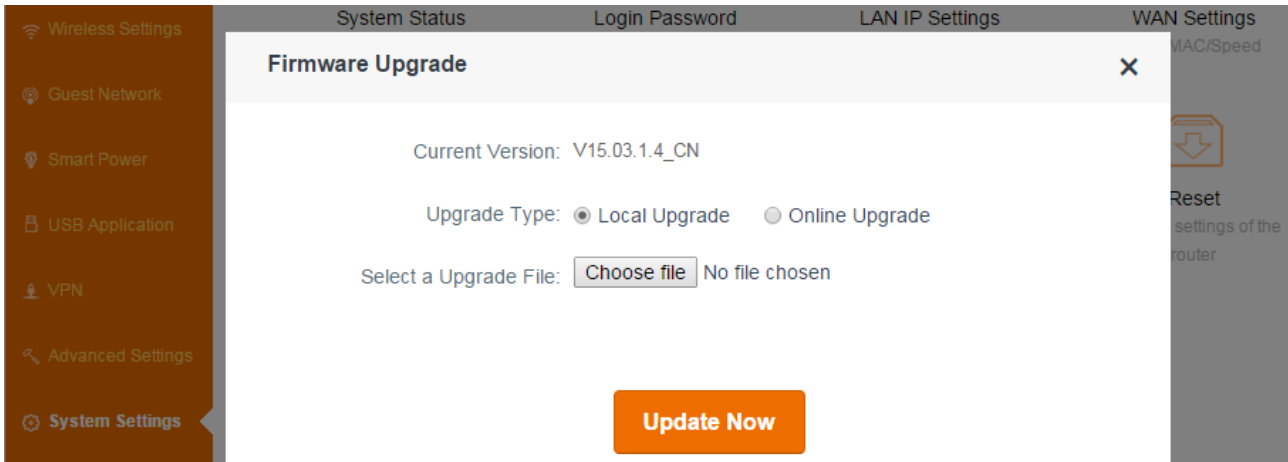

Configuration

- ① Download the firmware file from Tenda official website <http://www.tendacn.com>, save and unzip it to your local computer.
- ② Click **Choose file** to locate and select the upgrade file (.bin file) you saved.
- ③ Click **Update Now** to start the upgrade process.
- ④ Log in to the User Interface again to restore the Router to factory default. After that, follow the quick setup wizard to set up the Router.

Online Upgrade

The Router will detect the latest software automatically. When a newer software version is detected, you can upgrade.

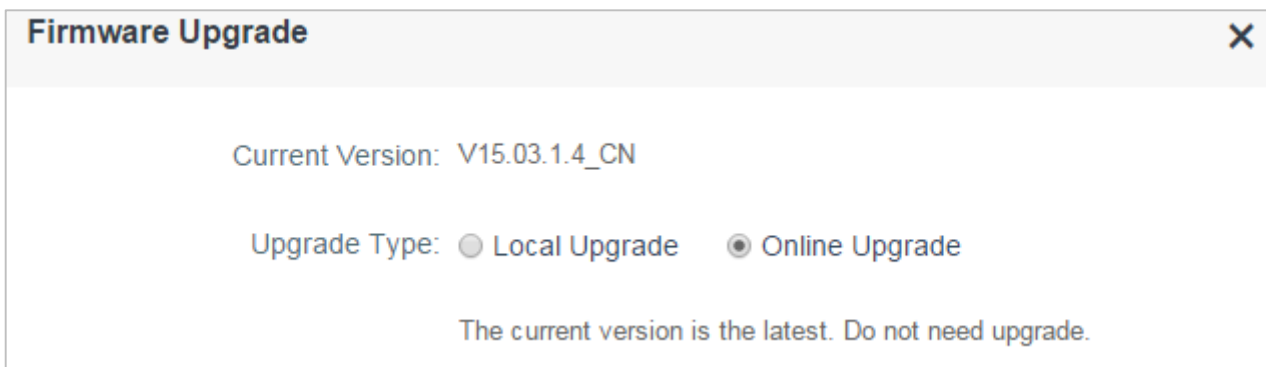

⚠ Note

While upgrading, verify that your computer is connected to the Router with an Ethernet cable, and the Router and your computer are kept with power supply. If not, damage might be done to the

Router.

Back/Restore

If you find the current settings can maintain a good performance for your Router, you can back up the configurations on time in case of need.

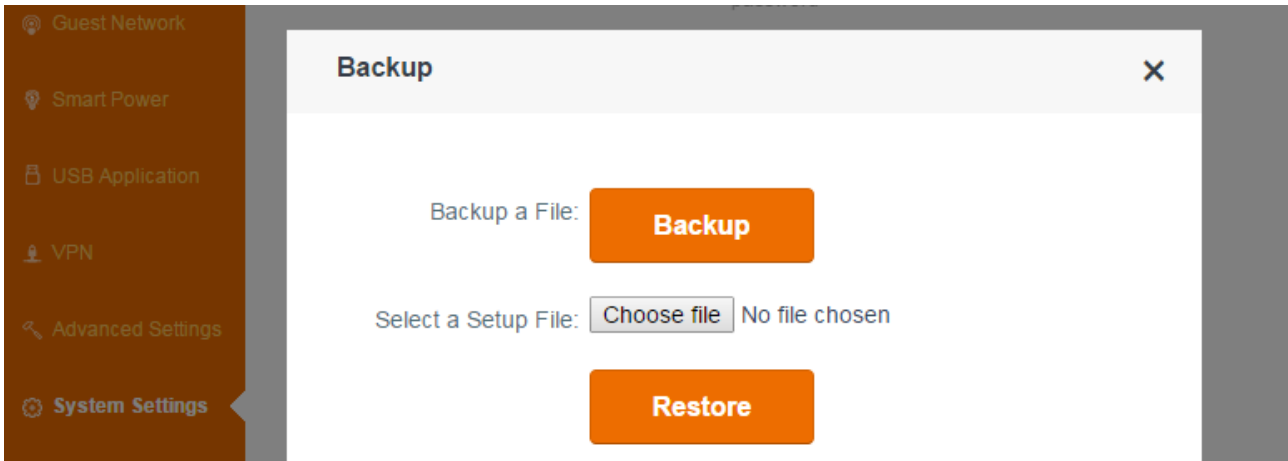

To backup a file:

Log in to the Router's User Interface, and click **Administration > Back/Restore**.

Click **Backup**, and locate the file (with suffix **.cfg**) to your host after finishing configuration of the Router.

To restore the configuration of the Router:

If you reset the Router carelessly, and don't want to reconfigure it, you can restore it using the configuration file you saved before.

- ① Click **Choose file**, and select the file you saved.
- ② Click **Restore**.

Reset

Here you can restore this Router to factory default. Two methods are available here.

Method One: Log in to the Router's User Interface, click **Administration > Reset**, and click **Reset**.

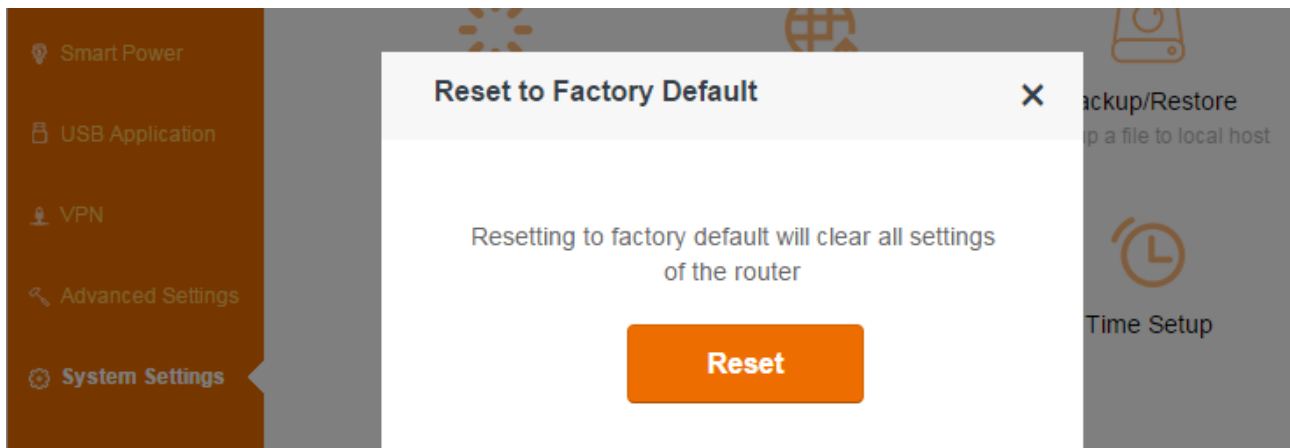

Method Two: Press and hold the **RST** button on the top panel for about 8 seconds and then release it to reset the Router to factory default settings.

Note

1. During the restoration, do not disconnect the power of the Router and other relevant devices.
2. After you restore the Router to factory default, you need to reconfigure the Router for accessing the Internet.
3. Strongly recommend you not to restore the Router, unless the following sequence appears:
 - You have to access the Router but you cannot remember the login name and password.
 - Your Router does not work well, and you want to reconfigure it by following the Setup Wizard.
 - You cannot access the Internet, and Tenda technical support recommends you to restore to factory default.

System Log

If you want to have a good knowledge of system operation, or when you have difficulties in surfing the Internet, you need to send your system logs to Tenda technical supporters.

Log in to the Router's User Interface, and click **Administration > System Log**.

Syslog
✕

Export

Number	Time	Type	Log
1	2015-05-12 10:03:12	wan	sending DHCP_release for ...
2	2015-05-12 09:55:18	lan	LAN2 up
3	2015-05-12 09:55:12	system	Sync time success

<<
<
>
>>

Auto Maintenance

Log in to the Router's User Interface, and click **Administration > Auto Maintenance**.

Auto Maintenance
✕

Auto Reboot:

If Auto reboot enabled, the router will auto-reboot to maintain itself during 03:00am~05:00am each day, once traffic drops below 5KB/s.

Save

Auto Maintenance helps you to maintain your Router automatically.

Time Setup

Log in to the Router's User Interface, and click **Administration > System Log**.

This part is used to set the Router's system time. Select your time zone, and you will get the GMT time from the Internet and the system will automatically connect to NTP server to synchronize the time.

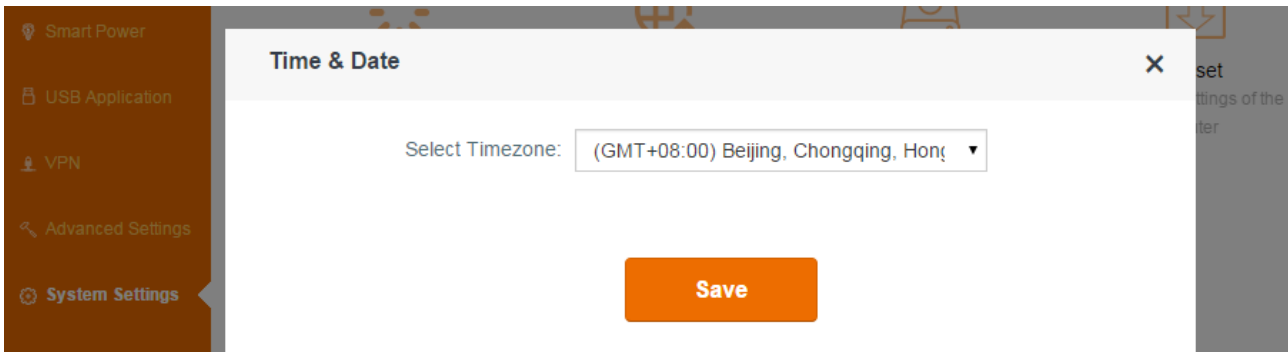

Tips

To make some time-based features (e.g. WiFi Schedule, System Log) effective, the time should be set correctly.

IV Appendix

This Chapter provides you with more information about how to configure your computer, common questions and answers, and etc.

This section contains the following items:

- ✧ [Configure Your computer](#)
- ✧ [App](#)
- ✧ [FAQs](#)
- ✧ [Technical Support](#)
- ✧ [Safety and Emission Statement](#)

1 Configure Your computer

Windows 8

1 Right click the icon  on the bottom right corner of your desktop. Click **Open Network and Sharing Center**.

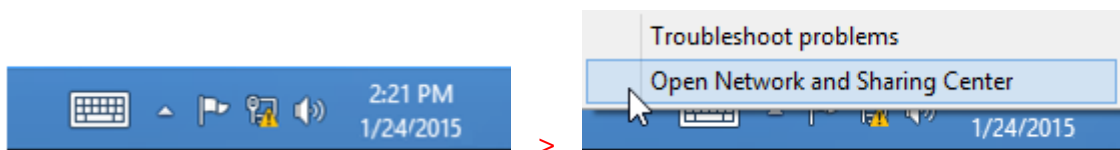

Tips

If you cannot find the icon , please move your cursor to the top right corner of your desktop, select **Settings > Control Panel > Network and Internet > Network and Sharing**.

2 Click **Ethernet > Properties**.

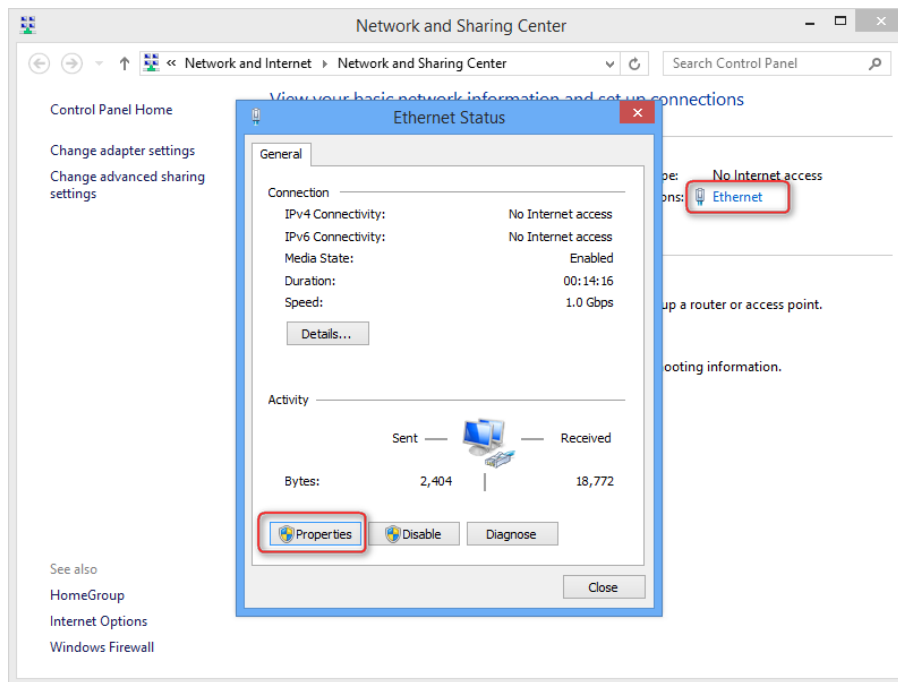

- Find and double click **Internet Protocol Version 4(TCP/IPv4)**. Select **Obtain an IP address automatically** and **Obtain DNS server address automatically** and click **OK**.

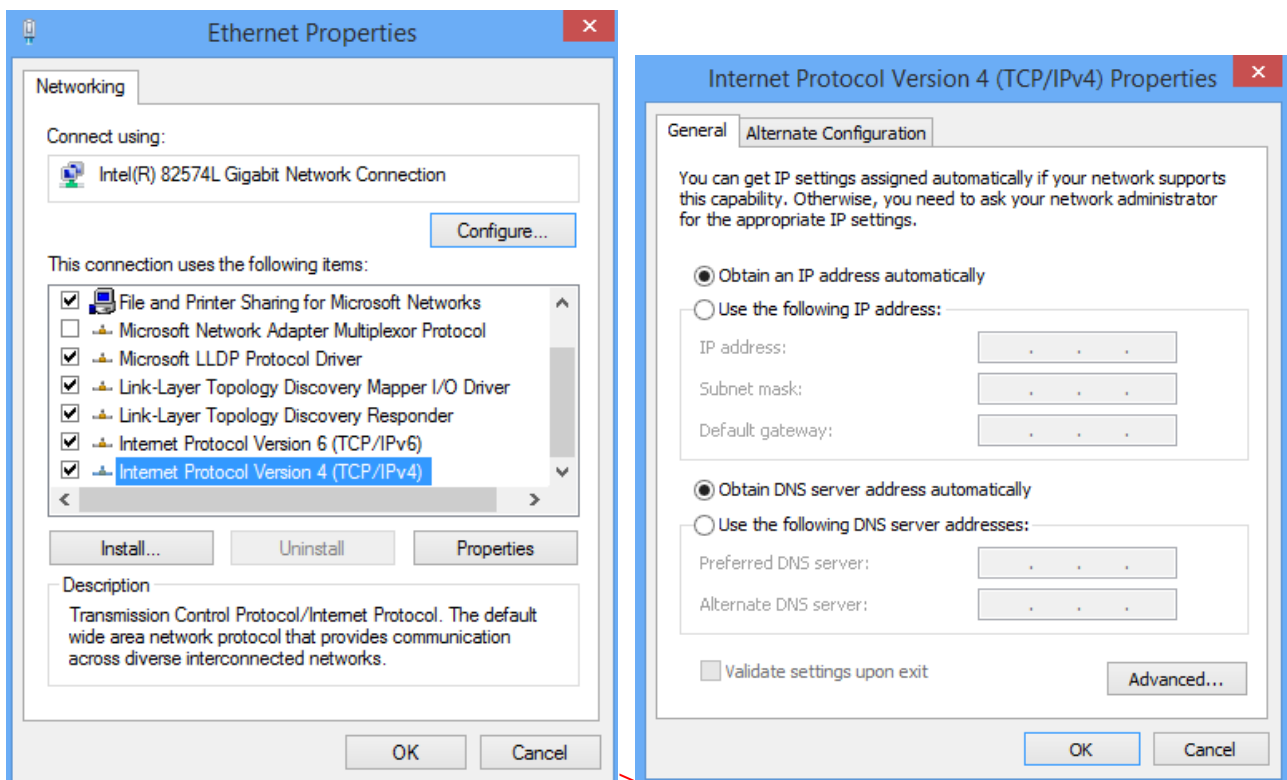

- Click **OK** on the **Ethernet Properties** window (see **3** for the screenshot).

Windows 7

- Click the icon  on the bottom right corner of your desktop. Click **Open Network and Sharing Center**.

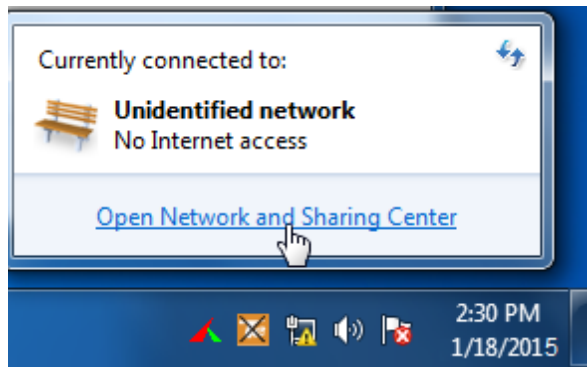

Tips

If you cannot find the icon  on the bottom right corner of your desktop, follow steps below: Click **Start > Control Panel > Network and Internet > Network and Sharing Center**.

2 Click **Local Area Connection > Properties**.

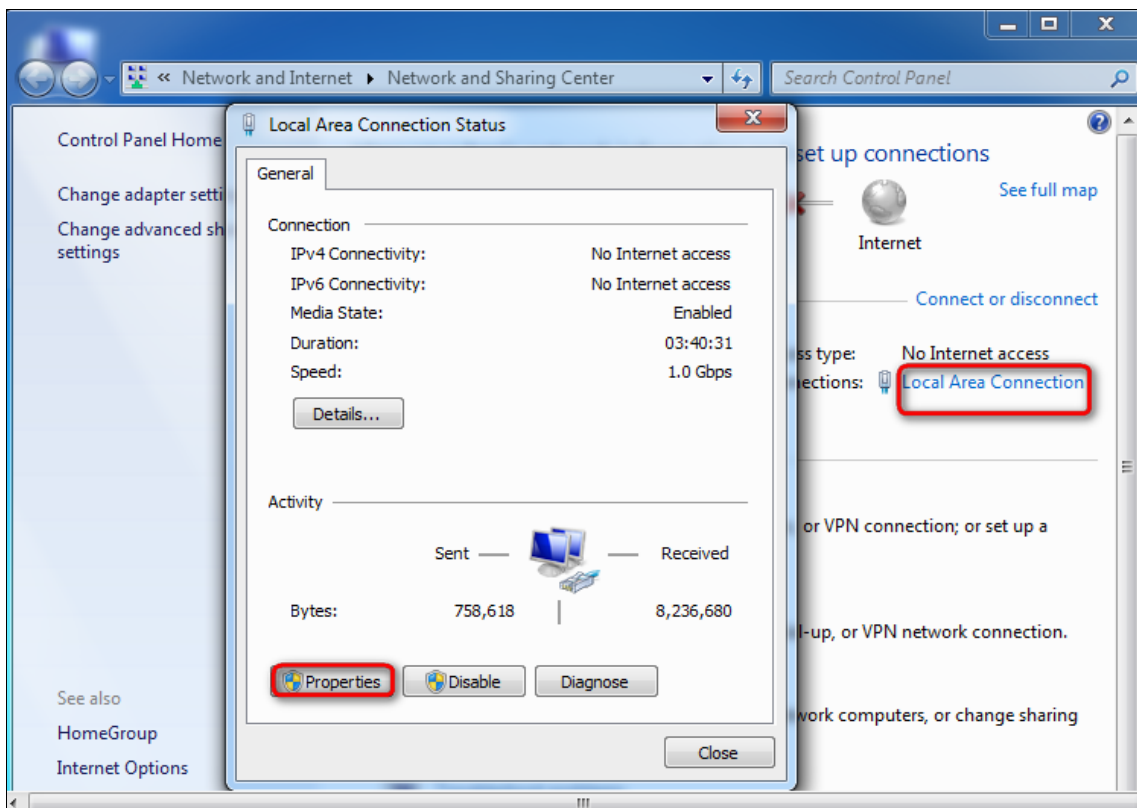

3 Find and double click **Internet Protocol Version 4(TCP/IPv4)**. Select **Obtain an IP address automatically** and **Obtain DNS server address automatically** and click **OK**.

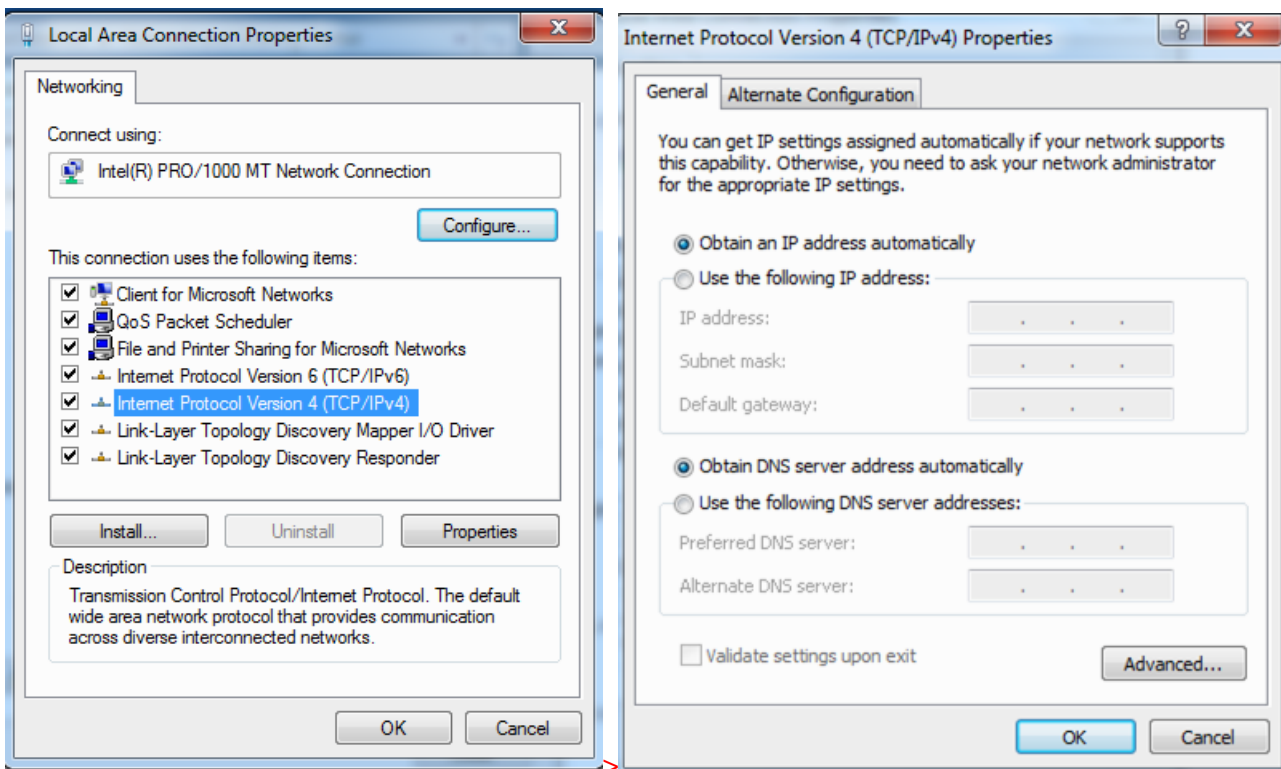

4 Click **OK** on the **Local Area Connection Properties** window (see 3 for the screenshot).

Windows XP

1 Right click **My Network Places** on your desktop and select **Properties**. Right click **Local Area Connection** and select **Properties**.

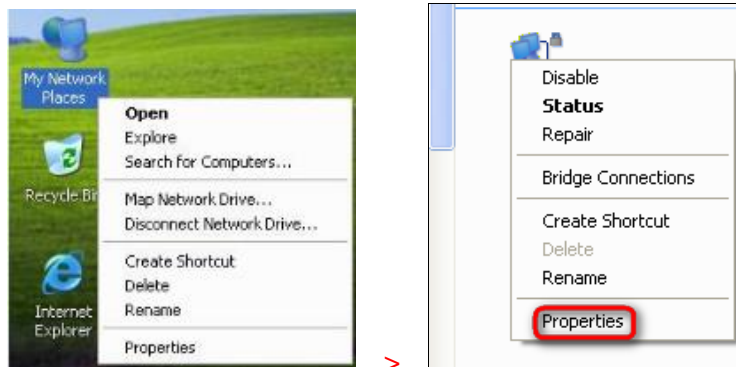

2 Scroll down to find and double click **Internet Protocol (TCP/IP)**. Select **Obtain an IP address automatically** and **Obtain DNS server address automatically** and click **OK**.

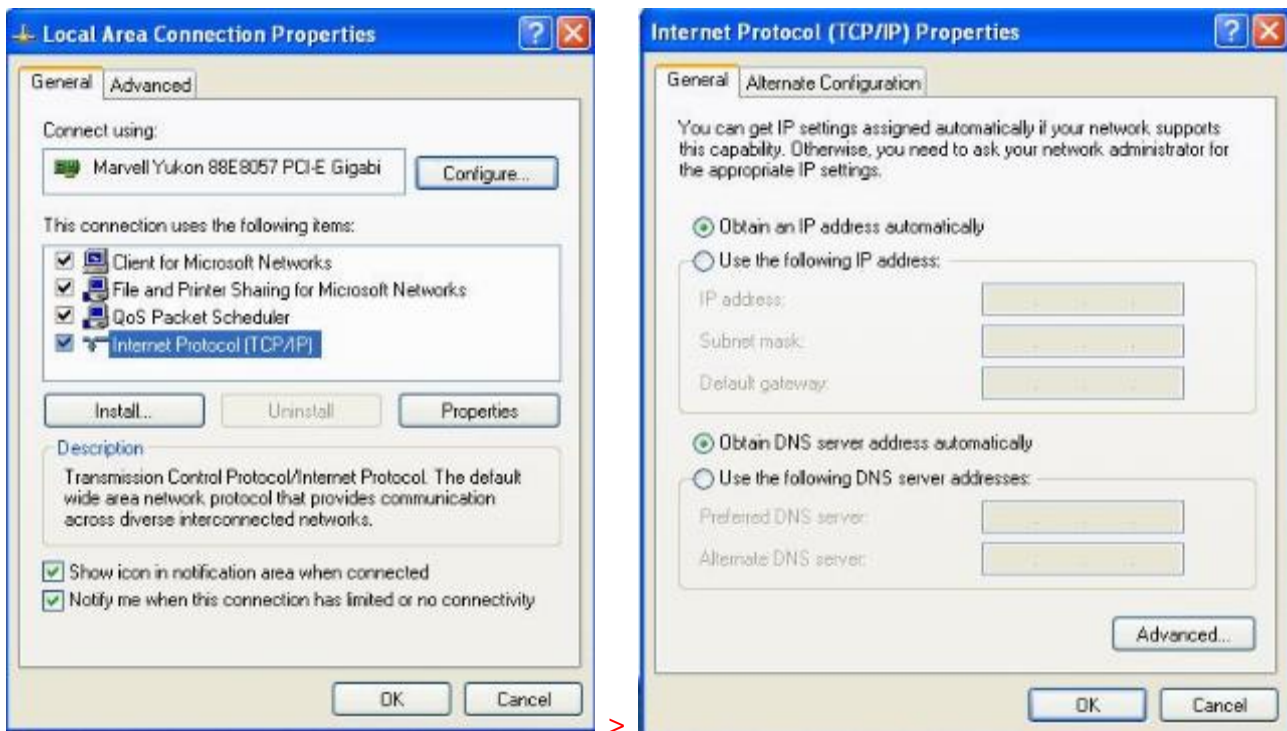

- 3 Click **OK** on the **Local Area Connection Properties** window (see 2 for the screenshot).

2 FAQs

Read the following **Frequently Asked Questions** if you are running into problems.

Q1: I cannot log in to the wireless router's Web Manager. What should I do?

A1: Please follow the instructions below step by step.

- a. Verify the Ethernet cable between your PC and the router is intact and well-connected. If not, use another Ethernet cable.
- b. Clear cache of your browser, or open another web browser.
- c. Double check the TCP/IP settings on your computer. Verify if it is set to obtain an IP automatically.
- d. Press and hold the **RST** button for about 8 seconds, then release it to restore factory settings; then try to login again.
- e. Try to login on another computer, smart phone or iPad.

Q2: I forget my WiFi password, what should I do?

A2: Please follow the instructions below step by step.

- a. Log in to the wireless router's User Interface, and find **Wireless Settings > WiFi Name & Password**.
- b. Restore the wireless router to factory default settings, and reset the WiFi password.
Restore Method: Press and hold the **RST** button for about 8 seconds and then release it.
The default WiFi password is on the label which can be found on the router's front or rear panel.

Q3: I cannot access the Internet after completing the configuration according to the instructions. What should I do?

A3: Please follow the instructions below step by step.

- a. Please check the connection and verify if it is well-connected.
- b. If your connection type is static IP, specific IP address and the other parameters must be filled out on the **Internet Settings** page first.
- c. Check whether you can access the Internet by connecting to the modem directly (without the router). If not, please double check the configuration of your modem or consult your ISP.

Q4: I cannot see the newly-added pictures via DLNA feature, what should I do?

A4: If you want to see the newly-added resources via DLNA, you need to re-enable the DLNA feature. Please disable DLNA feature in **USB Application > DLNA**, and enable it again in a few seconds.

3 Technical Support

If you still have some problems, please contact our technical support.

Country	Hotline
Global Hotline	(86) 755-27657180
United States	1-800-570-5892
Australia	1300787922
New Zealand	800787922
HongKong	00852-81931998
United Kingdom	44 0800 1337 824
Canada Hotline	1-888-998-8966

Type	Details
Skype	Tendasz
Website	http:// www.tendacn.com
E-mail	support@tenda.com.cn

4 Safety and Emission Statement

CE Mark Warning

Operations in the 5.15-5.25GHz band are restricted to indoor usage only.

This is a Class B product. In a domestic environment, this product may cause radio interference, in which case the user may be required to take adequate measures.

NOTE: (1) The manufacturer is not responsible for any radio or TV interference caused by unauthorized modifications to this equipment. (2) To avoid unnecessary radiation interference, it is recommended to use a shielded RJ45 cable

FCC Statement

This device is restricted to be used in the indoor.

This device complies with Part 15 of the FCC Rules. Operation is subject to the following two conditions: (1) This device may not cause harmful interference, and (2) this device must accept any interference received, including interference that may cause undesired operation.

This equipment has been tested and found to comply with the limits for a Class B digital device, pursuant to Part 15 of the FCC Rules. These limits are designed to provide reasonable protection against harmful interference in a residential installation. This equipment generates, uses and can radiate radio frequency energy and, if not installed and used in accordance with the instructions, may cause harmful interference to radio communications. However, there is no guarantee that interference will not occur in a particular installation. If this equipment does cause harmful interference to radio or television reception, which can be determined by turning the equipment off and on, the user is encouraged to try to correct the interference by one of the following measures:

- Reorient or relocate the receiving antenna.
- Increase the separation between the equipment and receiver.
- Connect the equipment into an outlet on a circuit different from that to which the receiver is connected.
- Consult the dealer or an experienced radio/TV technician for help.

FCC Caution: Any changes or modifications not expressly approved by the party responsible for compliance could void the user's authority to operate this equipment.

This transmitter must not be co-located or operating in conjunction with any other antenna or transmitter.

This equipment complies with FCC radiation exposure limits set forth for an uncontrolled environment. This equipment should be installed and operated with minimum distance 20cm between the radiator & your body.

NOTE: (1) The manufacturer is not responsible for any radio or TV interference caused by unauthorized modifications to this equipment. (2) To avoid unnecessary radiation interference, it is recommended to use a shielded RJ45 cable.