



User's Manual

Industrial 10-Port Gigabit Ethernet Switch

▶ IGS-10020MT



Trademarks

Copyright © PLANET Technology Corp. 2013.

Contents are subject to revision without prior notice.

PLANET is a registered trademark of PLANET Technology Corp. All other trademarks belong to their respective owners.

Disclaimer

PLANET Technology does not warrant that the hardware will work properly in all environments and applications, and makes no warranty and representation, either implied or expressed, with respect to the quality, performance, merchantability, or fitness for a particular purpose. PLANET has made every effort to ensure that this User's Manual is accurate; PLANET disclaims liability for any inaccuracies or omissions that may have occurred.

Information in this User's Manual is subject to change without notice and does not represent a commitment on the part of PLANET. PLANET assumes no responsibility for any inaccuracies that may be contained in this User's Manual. PLANET makes no commitment to update or keep current the information in this User's Manual, and reserves the right to make improvements to this User's Manual and/or to the products described in this User's Manual, at any time without notice.

If you find information in this manual that is incorrect, misleading, or incomplete, we would appreciate your comments and suggestions.

FCC Warning

This equipment has been tested and found to comply with the limits for a Class A digital device, pursuant to Part 15 of the FCC Rules. These limits are designed to provide reasonable protection against harmful interference when the equipment is operated in a commercial environment. This equipment generates, uses, and can radiate radio frequency energy and, if not installed and used in accordance with the Instruction manual, may cause harmful interference to radio communications. Operation of this equipment in a residential area is likely to cause harmful interference in which case the user will be required to correct the interference at whose own expense.

CE Mark Warning

This is a Class A product. In a domestic environment, this product may cause radio interference, in which case the user may be required to take adequate measures.

Energy Saving Note of the Device

This power required device does not support Standby mode operation. For energy saving, please remove the power cable to disconnect the device from the power circuit. Without removing power cable, the device will still consume power from the power source. In the view of saving energy and reducing the unnecessary power consumption, it is strongly suggested to remove the power connection for the device if this device is not intended to be active.

WEEE Warning



To avoid the potential effects on the environment and human health as a result of the presence of hazardous substances in electrical and electronic equipment, end users of electrical and electronic equipment should understand the meaning of the crossed-out wheeled bin symbol. Do not dispose of WEEE as unsorted municipal waste; it should be collected separately.

Revision

PLANET Industrial 8-Port 10/100/1000T + 2-Port 100/1000X SFP Managed Switch User's Manual

FOR MODEL: IGS-10020MT

REVISION: 2.0 (JUNE 2013)

Part No: EM-IGS-10020MT_v2.0 (2080-AH0560-001)

TABLE OF CONTENTS

1. INTRODUCTION	22
1.1 Packet Contents	22
1.2 Product Description	23
1.3 How to Use This Manual	25
1.4 Product Features	26
1.5 Product Specifications	29
2. INSTALLATION	31
2.1 Hardware Description	31
2.1.1 Physical Dimensions	31
2.1.2 Front Panel	32
2.1.3 LED Indicators	33
2.1.4 Switch Upper Panel	34
2.2 Install the Industrial Managed Switch	35
2.2.1 Installation Steps.....	35
2.2.2 DIN-Rail Mounting	36
2.2.3 Wall Mount Plate Mounting	38
2.3 Wiring the Power Inputs	39
2.4 Wiring the Fault Alarm Contact	39
2.5 Cabling	40
2.5.1 Installing the SFP Transceiver	41
2.5.2 Removing the Module.....	43
3. SWITCH MANAGEMENT	44
3.1 Requirements	44
3.2 Management Access Overview	45
3.3 Remote Telnet	46
3.4 Web Management	47
3.5 SNMP-based Network Management	48
3.6 PLANET Smart Discovery Utility	49

4. WEB CONFIGURATION	51
4.1 Main Web Page	54
4.2 System	56
4.2.1 System Information	57
4.2.2 IP Configuration	58
4.2.3 IPv6 Configuration	59
4.2.4 Users Configuration	60
4.2.5 Privilege Levels	62
4.2.6 NTP Configuration	65
4.2.7 UPnP	66
4.2.8 DHCP Relay	67
4.2.9 DHCP Relay Statistics	69
4.2.10 CPU Load	71
4.2.11 System Log	72
4.2.12 Detailed Log	73
4.2.13 Remote Syslog	74
4.2.14 SMTP Configuration	75
4.2.15 EEE Power Reduction	76
4.2.16 Web Firmware Upgrade	78
4.2.17 TFTP Firmware Upgrade	79
4.2.18 Configuration Backup	80
4.2.19 Configuration Upload	82
4.2.20 Image Select	83
4.2.21 Factory Default	85
4.2.22 System Reboot	86
4.2.23 Daylight Saving	87
4.3 Simple Network Management Protocol	89
4.3.1 SNMP Overview	89
4.3.2 SNMP System Configuration	90
4.3.3 SNMP System Information	93
4.3.4 SNMPv3 Configuration	94
4.3.4.1 SNMPv3 Communities	94
4.3.4.2 SNMPv3 Users	95
4.3.4.3 SNMPv3 Groups	97
4.3.4.4 SNMPv3 Views	98
4.3.4.5 SNMPv3 Access	99
4.4 Port Management	101
4.4.1 Port Configuration	101

4.4.2 Port Statistics Overview	103
4.4.5 Port Statistics Details	104
4.4.6 SFP Information	106
4.4.7 Port Mirror	107
4.5 Link Aggregation	109
4.5.1 Static Aggregation	111
4.5.2 LACP Configuration	113
4.5.3 LACP System Status	114
4.5.4 LACP Port Status	115
4.5.5 LACP Port Statistics	116
4.6 VLAN	117
4.6.1 VLAN Overview	117
4.6.2 IEEE 802.1Q VLAN	118
4.6.3 VLAN Basic Information	121
4.6.4 VLAN Port Configuration	122
4.6.5 VLAN Membership	126
4.6.6 VLAN Membership Status	127
4.6.7 VLAN Port Status	129
4.6.8 Private VLAN	130
4.6.9 Port Isolation	132
4.6.10 VLAN setting example:	134
4.6.10.1 Two separate 802.1Q VLAN	134
4.6.10.2 VLAN Trunking between two 802.1Q aware Switch	137
4.6.10.3 Port Isolate	139
4.6.11 MAC-based VLAN	140
4.6.12 MAC-based VLAN Status	141
4.6.13 IP Subnet-based VLAN	142
4.6.14 Protocol-based VLAN	143
4.6.15 Protocol-based VLAN Mambership	145
4.7 Spanning Tree Protocol	146
4.7.1 Theory	146
4.7.2 STP System Configuration	152
4.7.3 Bridge Status	154
4.7.4 CIST Port Configuration	155
4.7.5 MSTI Priorities	158
4.7.6 MSTI Configuration	159
4.7.7 MSTI Ports Configuration	161
4.7.8 Port Status	163
4.7.9 Port Statistics	164

4.8 Multicast	165
4.8.1 IGMP Snooping	165
4.8.2 IGMP Snooping Configuration	169
4.8.3 IGMP Snooping VLAN Configuration	170
4.8.4 IGMP Snooping Port Group Filtering	172
4.8.5 IGMP Snooping Status	173
4.8.6 IGMP Group Information.....	174
4.8.7 IGMPv3 Information.....	175
4.8.8 MLD Snooping Configuration.....	176
4.8.9 MLD Snooping VLAN Configuration	177
4.8.10 MLD Snooping Port Group Filtering.....	179
4.8.11 MLD Snooping Status	180
4.8.12 MLD Groups Information	181
4.8.13 MLDv2 Information	182
4.8.14 MVR.....	183
4.8.15 MVR Status.....	185
4.8.16 MVR Groups Information	186
4.8.17 MVR SFM Information	187
4.9 Quality of Service	188
4.9.1 Understand QOS	188
4.9.2 Port Policing	189
4.9.3 Port Classification.....	190
4.9.3.1 QoS Ingress Port Tag Classification	191
4.9.4 Port Scheduler.....	192
4.9.5 Port Shaping.....	193
4.9.5.1 QoS Egress Port Schedule and Shapers	194
4.9.6 Port Tag Remarking.....	195
4.9.6.1 QoS Egress Port Tag Remarking.....	196
4.9.7 Port DSCP.....	197
4.9.8 DSCP-Based QoS	199
4.9.9 DSCP Translation	200
4.9.10 DSCP Classification.....	202
4.9.11 QoS Control List.....	203
4.9.11.1 QoS Control Entry Configuration	205
4.9.12 QoS Status	207
4.9.13 Storm Control Configuration	209
4.9.14 QoS Statistics	210
4.9.15 Voice VLAN Configuration	211
4.9.16 Voice VLAN OUI Table.....	213

4.10 Access Control Lists	214
4.10.1 Access Control List Status	214
4.10.2 Access Control List Configuration	216
4.10.3 ACE Configuration	218
4.10.4 ACL Ports Configuration	226
4.10.5 ACL Rate Limiter Configuration	228
4.11 Authentication	230
4.11.1 Understanding IEEE 802.1X Port-based Authentication	231
4.11.2 Authentication Configuration	235
4.11.3 Network Access Server Configuration.....	236
4.11.4 Network Access Overview	246
4.11.5 Network Access Statistics	247
4.11.6 Authentication Server Configuration.....	254
4.11.7 RADIUS Overview	257
4.11.8 RADIUS Details	259
4.11.9 Windows Platform RADIUS Server Configuration.....	266
4.11.10 802.1X Client Configuration	271
4.12 Security	274
4.12.1 Port Limit Control	274
4.12.2 Access Management	278
4.12.3 Access Management Statistics	279
4.12.4 HTTPs	280
4.12.5 SSH	281
4.12.6 Port Security Status	282
4.12.7 Port Security Detail	284
4.12.8 DHCP Snooping	285
4.12.9 DHCP Snooping Statistics	286
4.12.10 IP Source Guard Configuration.....	288
4.12.11 IP Source Guard Static Table	289
4.12.12 ARP Inspection	290
4.12.13 ARP Inspection Static Table	291
4.13 MAC Address Table	292
4.13.1 MAC Address Table Configuration	292
4.13.2 MAC Address Table Status	294
4.13.3 Dynamic ARP Inspection Table.....	295
4.13.4 Dynamic IP Source Guard Table.....	297
4.14 LLDP	298
4.14.1 Link Layer Discovery Protocol	298

4.14.2 LLDP Configuration	298
4.14.3 LLDP-MED Configuration	302
4.14.4 LLDP-MED Neighbor	308
4.14.5 Neighbor	311
4.14.6 Port Statistics	313
4.14.7 LLDP Neighbor EEE Information	315
4.15 Diagnostics	317
4.15.1 Ping	318
4.15.2 IPv6 Ping	319
4.15.3 Remote IP Ping Test	320
4.15.4 Cable Diagnostics	321
4.16 Loop Protection	322
4.16.1 Configuration	322
4.16.2 Status	323
4.17 RMON	324
4.17.1 RMON Alarm Configuration	324
4.17.2 RMON Alarm Detail	326
4.17.3 RMON Alarm Status	327
4.17.4 RMON Event Configuration	328
4.17.5 RMON Event Detail	329
4.17.6 RMON Event Status	330
4.17.7 RMON History Configuration	331
4.17.8 RMON History Detail	332
4.17.9 RMON History Status	333
4.17.10 RMON Statistics Configuration	335
4.17.11 RMON Statistics Detail	336
4.18 Precision Time Protocol	338
4.18.1 PTP Configuration	338
4.18.2 PTP Status	340
4.19 Ring	342
4.19.1 MEP Configuration	343
4.19.2 Detailed MEP Configuration	344
4.19.3 Ethernet Ring Protocol Switch	347
4.19.4 Ethernet Ring Protocol Switch Configuration	349
4.19.5 Ring Wizard	352
4.19.6 Ring Wizard Example:	353
5. COMMAND LINE INTERFACE	356

5.1 Accessing the CLI	356
5.2 Telnet Login	356
6. COMMAND LINE MODE	357
6.1 System Command	358
System Configuration	358
System Log Configuration	358
System Version	359
System Log Server Mode	359
System Name	360
System Contact	360
System Log Server Address	361
System Location	361
System Log Level	362
System Timezone	363
System Log Lookup	363
System Reboot	364
System Restore Default	364
System Load	365
6.2 IP Command	365
IP Configuration	365
IP DHCP	366
IP Setup	366
IP Ping	367
IP DNS	368
IP DNS Proxy	368
IPv6 AUTOCINFIG	369
IPv6 Setup	369
IPv6 Ping	370
IP NTP Configuration	371
IP NTP Mode	371
IP NTP Server Add	372
IP NTP Server IPv6 Add	372
IP NTP Server Delete	373
6.3 Port Management Command	374
Port Configuration	374
Port Mode	374
Port Flow Control	375

Port State.....	376
Port Maximum Frame.....	376
Port Power.....	377
Port Excessive.....	377
Port Statistics.....	378
Port VeriPHY.....	378
Port SFP.....	379
6.4 MAC Address Table Command.....	380
MAC Configuration.....	380
MAC Add.....	380
MAC Delete.....	381
MAC Lookup.....	381
MAC Age Time.....	382
MAC Learning.....	382
MAC Dump.....	383
MAC Statistics.....	383
MAC Flush.....	384
6.5 VLAN Configuration Command.....	385
VLAN Configuration.....	385
VLAN PVID.....	385
VLAN Frame Type.....	386
VLAN Ingress Filter.....	387
VLAN Mode.....	387
VLAN Link Type.....	388
VLAN Q-in-Q Mode.....	388
VLAN Ethernet Type.....	389
VLAN Add.....	389
VLAN Forbidden Add.....	390
VLAN Delete.....	390
VLAN Forbidden Delete.....	391
VLAN Forbidden Lookup.....	391
VLAN Lookup.....	392
VLAN Name Add.....	392
VLAN Name Delete.....	393
VLAN Name Lookup.....	393
VLAN Status.....	394
6.6 Private VLAN Configuration Command.....	395
PVLAN Configuration.....	395
PVLAN Add.....	396

PVLAN Delete	396
PVLAN Lookup.....	397
PVLAN Isolate	397
6.7 Security Command.....	398
Security Switch User Configuration	398
Security Switch User Add	398
Security Switch User Delete	399
Security Switch Privilege Level Configuration	399
Security Switch Privilege Level Group.....	401
Security Switch Privilege Level Current.....	401
Security Switch Auth Configuration	401
Security Switch Auth Method.....	402
Security Switch SSH Configuration	403
Security Switch SSH Mode.....	403
Security Switch HTTPs Configuration	404
Security Switch HTTPs Mode.....	404
Security Switch HTTPs Redirect	405
Security Switch Access Configuration	405
Security Switch Access Mode.....	406
Security Switch Access Configuration	406
Security Switch Access Mode.....	407
Security Switch Access Add	407
Security Switch Access IPv6 Add	408
Security Switch Access Delete	409
Security Switch Access Lookup.....	409
Security Switch Access Clear	410
Security Switch Access Statistics	410
Security Switch SNMP Configuration	411
Security Switch SNMP Mode.....	411
Security Switch SNMP Version.....	411
Security Switch SNMP Read Community.....	412
Security Switch SNMP Write Community	413
Security Switch SNMP Trap Mode.....	413
Security Switch SNMP Trap Version.....	414
Security Switch SNMP Trap Community	414
Security Switch SNMP Trap Destination.....	415
Security Switch SNMP Trap IPv6 Destination	415
Security Switch SNMP Trap Authentication Failure	416
Security Switch SNMP Trap Link-up.....	416
Security Switch SNMP Trap Inform Mode	417

Security Switch SNMP Trap Inform Timeout.....	417
Security Switch SNMP Trap Inform Retry Times	418
Security Switch SNMP Trap Probe Security Engine ID	418
Security Switch SNMP Trap Security Engine ID	419
Security Switch SNMP Trap Security Name	419
Security Switch SNMP Engine ID	420
Security Switch SNMP Community Add	420
Security Switch SNMP Community Delete	421
Security Switch SNMP Community Lookup	421
Security Switch SNMP User Add	422
Security Switch SNMP User Delete	422
Security Switch SNMP User Changekey	423
Security Switch SNMP User Lookup	423
Security Switch SNMP Group Add.....	424
Security Switch SNMP Group Delete	425
Security Switch SNMP Group Lookup	425
Security Switch SNMP View Add	426
Security Switch SNMP View Delete.....	426
Security Switch SNMP View Lookup	427
Security Switch SNMP Access Add	427
Security Switch SNMP Access Delete	428
Security Switch SNMP Access Lookup.....	428
Security Network Psec Switch.....	429
Security Network Psec Port.....	430
Security Network Limit Configuration	430
Security Network Limit Mode	431
Security Network Limit Aging.....	432
Security Network Limit Agetime	432
Security Network Limit Port	433
Security Network Limit Limit	433
Security Network Limit Action	434
Security Network Limit Reopen	434
Security Network NAS Configuration.....	435
Security Network NAS Mode	436
Security Network NAS State	436
Security Network NAS Reauthentication	437
Security Network NAS ReauthPeriod	438
Security Network NAS EapolTimeout	438
Security Network NAS Agetime	439
Security Network NAS Holdtime	439

Security Network NAS RADIUS_QoS	440
Security Network NAS RADIUS_VLAN	440
Security Network NAS Guest_VLAN	441
Security Network NAS Authenticate	442
Security Network NAS Statistics	442
Security Network ACL Configuration	443
Security Network ACL Action	443
Security Network ACL Policy	444
Security Network ACL Rate	445
Security Network ACL Add	445
Security Network ACL Delete	447
Security Network ACL Lookup	447
Security Network ACL Clear	448
Security Network ACL Status	448
Security Network DHCP Relay Configuration	448
Security Network DHCP Relay Mode	449
Security Network DHCP Relay Server	450
Security Network DHCP Relay Information Mode	450
Security Network DHCP Relay Information Policy	451
Security Network DHCP Relay Statistics	451
Security Network DHCP Snooping Configuration	452
Security Network DHCP Snooping Mode	452
Security Network DHCP Snooping Port Mode	453
Security Network DHCP Snooping Statistics	453
Security Network IP Source Guard Configuration	454
Security Network IP Source Guard Mode	454
Security Network IP Source Guard Port Mode	455
Security Network IP Source Guard Limit	455
Security Network IP Source Guard Entry	456
Security Network IP Source Guard Status	456
Security Network ARP Inspection Configuration	457
Security Network ARP Inspection Mode	457
Security Network ARP Inspection Port Mode	458
Security Network ARP Inspection Entry	458
Security Network ARP Inspection Status	459
Security AAA Configuration	459
Security AAA Timeout	460
Security AAA Deadtime	461
Security AAA RADIUS	461
Security AAA ACCT_RADIUS	462

Security AAA TACACS+	463
Security AAA Statistics.....	463
6.8 Spanning Tree Protocol Command	464
STP Configuration	464
STP Version	464
STP Tx Hold	465
STP MaxHops	465
STP MaxAge	466
STP FwdDelay	466
STP CName	467
STP BPDU Filter.....	467
STP BPDU Guard.....	468
STP Recovery	468
STP Status	469
STP MSTI Priority.....	470
STP MSTI Map.....	470
STP MSTI Add.....	471
STP Port Configuration.....	471
STP Port Mode.....	472
STP Port Edge	472
STP Port AutoEdge	473
STP Port P2P	473
STP Port RestrictedRole	474
STP Port RestrictedTcn	474
STP Port bpduGuard	475
STP Port Statistic.....	475
STP Port Mcheck.....	476
STP MSTI Port Configuration	476
STP MSTI Port Cost.....	477
STP MSTI Port Priority	477
6.9 Link Aggregation Command	478
Aggregation Configuration.....	478
Aggregation Add.....	478
Aggregation Delete.....	478
Aggregation Lookup	479
Aggregation Mode	479
6.10 Link Aggregation Control Protocol Command.....	480
LACP Configuration.....	480
LACP Mode	481

LACP Key.....	481
LACP Role.....	482
LACP Status	482
LACP Statistics.....	483
6.11 LLDP Command.....	484
LLDP Configuration	484
LLDP Mode	484
LLDP Optional TLV.....	485
LLDP Interval.....	486
LLDP Hold	486
LLDP Delay	487
LLDP Reinit	487
LLDP Statistics	488
LLDP Info	488
6.12 LLDPMED Command	489
LLDPMED Configuration	489
LLDPMED Civic.....	490
LLDPMED ECS	491
LLDPMED Policy Delete.....	491
LLDPMED Policy Add.....	491
LLDPMED Port Policy	492
LLDPMED Coordinates	493
LLDPMED Datum.....	493
LLDPMED Fast	494
LLDPMED Info	494
6.13 EEE Command.....	495
EEE Configuration	495
EEE Mode	495
EEE Urgent Queues.....	496
6.14 Thermal Command.....	497
Thermal Priority Temperature	497
Thermal Port Priority	497
Thermal Status	498
Thermal Configuration.....	498
6.15 Quality of Service Command	499
QoS Configuration	499
QoS Port Classification Class.....	499
QoS Port Classification DPL.....	500

QoS Port Classification PCP	500
QoS Port Classification DEI.....	501
QoS Port Classification Tag.....	501
QoS Port Classification Map.....	502
QoS Port Classification DSCP.....	502
QoS Port Policer Mode.....	503
QoS Port Policer Rate.....	503
QoS Port Policer Unit.....	504
QoS Port Scheduler Mode.....	504
QoS Port Scheduler Weight.....	505
QoS Port QueueShaper Mode.....	505
QoS Port QueueShaper Rate.....	506
QoS Port QueueShaper Excess.....	506
QoS Port Shaper Mode.....	507
QoS Port Shaper Rate.....	507
QoS Port TagRemarking Mode.....	508
QoS Port TagRemarking PCP.....	508
QoS Port TagRemarking DEI.....	509
QoS Port TagRemarking Map.....	509
QoS Port DSCP Translation.....	510
QoS Port DSCP Classification.....	511
QoS Port DSCP EgressRemark.....	511
QoS DSCP Map.....	512
QoS DSCP Translation.....	512
QoS DSCP Trust.....	513
QoS DSCP Classification Mode.....	513
QoS DSCP EgressRemap.....	514
QoS Storm Unicast.....	514
QoS Storm Multicast.....	515
QoS QCL Add.....	515
QoS QCL Delete.....	516
QoS QCL Lookup.....	517
QoS QCL Status.....	517
QoS QCL Refresh.....	518
6.16 Mirror Command	519
Mirror Configuration.....	519
Mirror Port.....	519
Mirror Mode.....	520
6.17 Configuration Command	521

Configuration Save	521
Configuration Load	521
6.18 Firmware Command.....	522
Firmware Load	522
Firmware IPv6 Load	522
Firmware Information	522
Firmware Swap	522
6.19 UPnP Command	523
UPnP Configuration.....	523
UPnP Mode	523
UPnP TTL.....	524
UPnP Advertising Duration	524
6.20 MVR Command.....	525
MVR Configuration	525
MVR Group	526
MVR Status	526
MVR Mode	526
MVR Port Mode.....	527
MVR Multicast VLAN.....	527
MVR Port Type.....	528
MVR Immediate Leave.....	528
6.21 Voice VLAN Command.....	529
Voice VLAN Configuration	529
Voice VLAN Mode	530
Voice VLAN ID.....	531
Voice VLAN Agetime	531
Voice VLAN Traffic Class.....	532
Voice VLAN OUI Add.....	532
Voice VLAN OUI Delete.....	533
Voice VLAN OUI Clear	533
Voice VLAN OUI Lookup	534
Voice VLAN Port Mode.....	534
Voice VLAN Security	535
6.22 Loop Protect Command.....	535
Loop Protect Configuration.....	535
Loop Protect Mode	535
Loop Protect Transmit	536
Loop Protect Shutdown	536

Loop Protect Port Configuration	537
Loop Protect Port Mode.....	537
Loop Protect Port Action.....	537
6.23 IPMC Command.....	538
IPMC Configuration	538
IPMC Mode	538
IPMC Flooding.....	538
IPMC Leave Proxy	539
IPMC Proxy	540
IPMC State	540
IPMC Querier	541
IPMC Fastleave.....	541
IPMC Throttling	542
IPMC Filtering.....	543
IPMC Router.....	543
IPMC Status	544
IPMC Group	544
IPMC Version	545
IPMC SSM.....	545
IPMC Parameter RV.....	546
IPMC Parameter QI.....	546
IPMC Parameter QRI	547
IPMC Parameter LLQI.....	547
IPMC Parameter URI	548
6.24 VLAN Control List Command.....	548
VCL MAC-based VLAN Configuration	548
VCL MAC-based VLAN Add	548
VCL MAC-based VLAN Delete	549
VCL Stasus.....	549
VCL Protocol-based VLAN Add Ethernet II	549
VCL Protocol-based VLAN Add SNAP	550
VCL Protocol-based VLAN Add LLC	550
VCL Protocol-based VLAN Delete Ethernet II	550
VCL Protocol-based VLAN Delete SNAP	551
VCL Protocol-based VLAN Delete LLC	551
VCL Protocol-based VLAN Add	551
VCL Protocol-based VLAN Delete.....	552
VCL Protocol-based VLAN Configuration.....	552
6.25 SMTP Command.....	552

SMTP Configuration	552
SMTP Mode	552
SMTP Server	553
SMTP Auth	553
SMTP Auth_user	554
SMTP Auth_pass	554
SMTP Mailfrom	554
SMTP Mailsubject	555
SMTP Mailto1	555
SMTP Mailto2	555
SMTP Test	556
6.26 Ethernet Virtual Connections Command	557
EVC Configuration	557
EVC Port DEI	557
EVC Port Tag	557
EVC Port Addr	558
EVC Port L2CP	558
EVC Policer	558
EVC Add	559
EVC Delete	559
EVC Lookup	560
EVC Status	560
EVC Statistics	560
EVC ECE Add	561
EVC ECE Delete	562
EVC ECE Lookup	562
EVC ECE Status	563
6.27 Ethernet Protection Switching Command	564
EPS Create	564
EPS Config	564
EPS Command	565
EPS State	565
6.28 Maintenance entity End Point Command	566
MEP Config	566
MEP Peer MEP	567
MEP Continuity Check Configuration	567
MEP Loss Measurement Configuration	567
MEP APS Configuration	568
MEP Client Configuration	568

MEP AIS Configuration	569
MEP LCK Configuration	569
MEP Link Trace Configuration	570
MEP Loop Back Configuration	570
MEP Delay Measurement Configuration	571
MEP Test Signal Configuration	572
MEP State	573
MEP Loss Measurement State	573
MEP Loss Measurement State Clear	573
MEP Link Trace State	574
MEP Loop Back State	574
MEP Delay Measurement State	574
MEP Delay Measurement State Clear	575
MEP Test Signal State	575
MEP Test Signal State Clear	575
6.29 Ethernet Ring Protection Switching Command	576
ERPS Command	576
ERPS Version	576
ERPS Add	576
ERPS Reversion	577
ERPS VLAN Add	577
ERPS VLAN Delete	578
ERPS MEP	578
ERPS RPL Neighbor	579
ERPS RPL Owner	579
ERPS RPL Neighbor Clear	580
ERPS RPL Owner Clear	580
ERPS Hold Off Timeout	580
ERPS Guard-timeout	581
ERPS WRT-timeout	581
ERPS Delete	581
ERPS Topologychange	582
ERPS Configurationt	582
6.30 PTP Command	583
PTP Configuration	583
PTP PortState	583
PTP ClockCreate	583
PTP ClockDelete	585
PTP DefaultDS	585

PTP CurrentDS	586
PTP ParentDS	586
PTP Timingproperties	586
PTP PortDataSet	587
PTP LocalClock	588
PTP Filter	588
PTP Servo	589
PTP SlaveTableUnicast	589
PTP SlaveTableUnicast	590
PTP ForeignMasters	590
PTP EgressLatency	590
PTP MasterTableUnicast	591
PTP ExtClockMode	591
PTP OnePpsAction	592

7. SWITCH OPERATION 593

7.1 Address Table 593

7.2 Learning 593

7.3 Forwarding & Filtering 593

7.4 Store-and-Forward 593

7.5 Auto-Negotiation 594

8. TROUBLESHOOTING 595

APPENDIX A 597

A.1 Switch's Data RJ-45 Pin Assignments - 1000Mbps, 1000Base-T 597

A.2 10/100Mbps, 10/100Base-TX 597

APPENDIX B : GLOSSARY 599

1. INTRODUCTION

PLANET IGS-10020MT **Industrial 8-Port 10/100/1000T + 2-Port 100/1000X SFP Managed Switch (-40~75 Degree C)** is a managed switch with multiple Gigabit copper ports plus two Gigabit SFP mini-GBIC slots with fiber optical connective ability and robust layer 2 features. "**Industrial Managed Switch**" mentioned in the User's Manual represents the IGS-10020MT,

1.1 Packet Contents

Open the box of the Industrial Managed Switch and carefully unpack it. The box should contain the following items:

<input checked="" type="checkbox"/> The Industrial Managed Switch	x1
<input checked="" type="checkbox"/> Quick Installation Guide	x1
<input checked="" type="checkbox"/> User's Manual CD	x1
<input checked="" type="checkbox"/> DIN Rail Kit	x1
<input checked="" type="checkbox"/> Wall Mounting Kit	X1
<input checked="" type="checkbox"/> Dust Cap	X10

If any of these are missing or damaged, please contact your dealer immediately; if possible, retain the carton including the original packing material, and use them again to repack the product in case there is a need to return it to us for repair.

1.2 Product Description



PLANET IGS-10020MT is an **Industrial 10-Port Full Gigabit Managed Ethernet Switch** specially designed to build a full Gigabit backbone to transmit reliable but high speed data in heavy industrial demanding environments and forward data to remote network through fiber optic. It provides **8-Port 10/100/1000Base-T copper** and **2 extra 100/1000Base-X SFP fiber optic interfaces** delivered in an IP30 rugged strong case with redundant power system. Besides support for 20Gbps switch fabric to handle extremely large amounts of video, voice and important data in a secure topology, the IGS-10020MT provides user-friendly but advanced **IPv6 / IPv4 management** interfaces and abundant L2 / L4 switching functions. It is the best investment for industrial business expanding or upgrading its network infrastructure.

IPv6 / IPv4 Full-functioned Secure Switch for Building Automation Networking

The IGS-10020MT is the ideal solution to fulfilling the demand of IPv6 management Gigabit Ethernet Switch, especially in the Industrial hardened environment. It supports both IPv4 and IPv6 management functions and can work with original network structure. It provides advanced Layer 2 to Layer 4 data switching and redundancy, Quality of Service traffic control, network access control and authentication, and Secure Management features to protect customer's industrial and building automation network connectivity with reliable switching recovery capability that is suitable for implementing fault tolerant and mesh network architectures.

Redundant Ring, Fast Recovery for Surveillance System

The IGS-10020MT supports redundant ring technology and features strong rapid self-recovery capability to prevent interruptions and external intrusions. It incorporates advanced ITU-T **G.8032 ERPS (Ethernet Ring Protection Switching)** technology, Spanning Tree Protocol (802.1s MSTP), and **redundant power** input system into customer's industrial automation network to enhance system reliability and uptime in harsh factory environments. In certain simple Ring network, the recovery time of data link can be as fast as 20 ms.

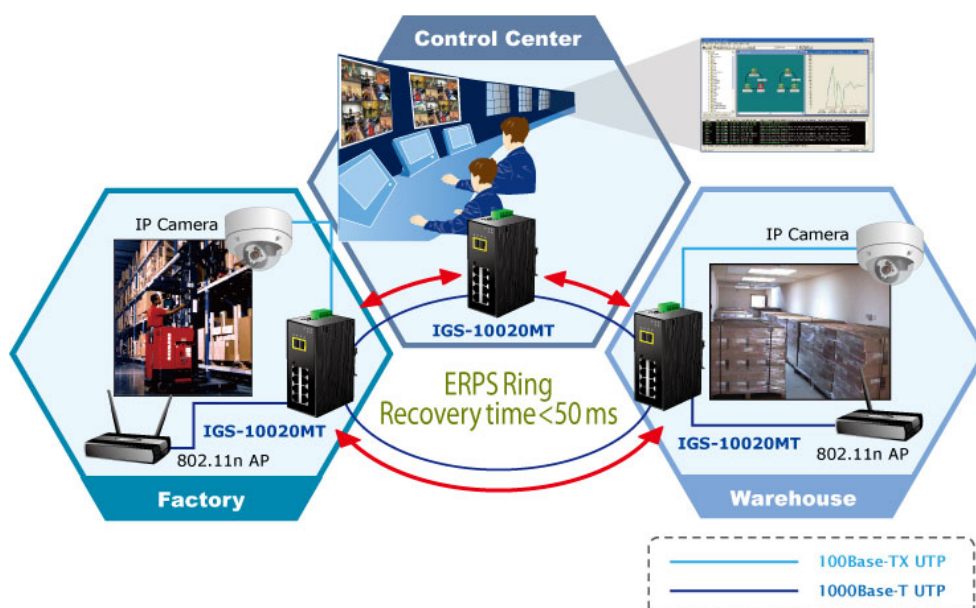

Environmentally Hardened Design

With IP30 aluminum industrial case protection, the IGS-10020MT provides a high level of immunity against electromagnetic interference and heavy electrical surges which are usually found on plant floors or in curb side traffic control cabinets. It also possesses an integrated power supply source with wide range of voltages (**12 to 48V DC** or **24V AC**) for worldwide high availability applications requiring dual or backup power inputs. Being able to operate under the temperature range from -40 to 75 degrees C, the IGS-10020MT can be placed in almost any difficult environment.

Flexible and Extendable Solution

The 2 mini-GBIC slots built in the IGS-10020MT support Dual-Speed, **100Base-FX** and **1000Base-SX/LX SFP** (Small Form-factor Pluggable) fiber-optic modules, meaning the administrator now can flexibly choose the suitable SFP transceiver according to the transmission distance or the transmission speed required to extend the network efficiently. The IGS-10020MT supports SFP-**DDM (Digital Diagnostic Monitor)** function that can easily monitor real-time parameters of the SFP for network administrator, such as optical output power, optical input power, temperature, laser bias current, and transceiver supply voltage.

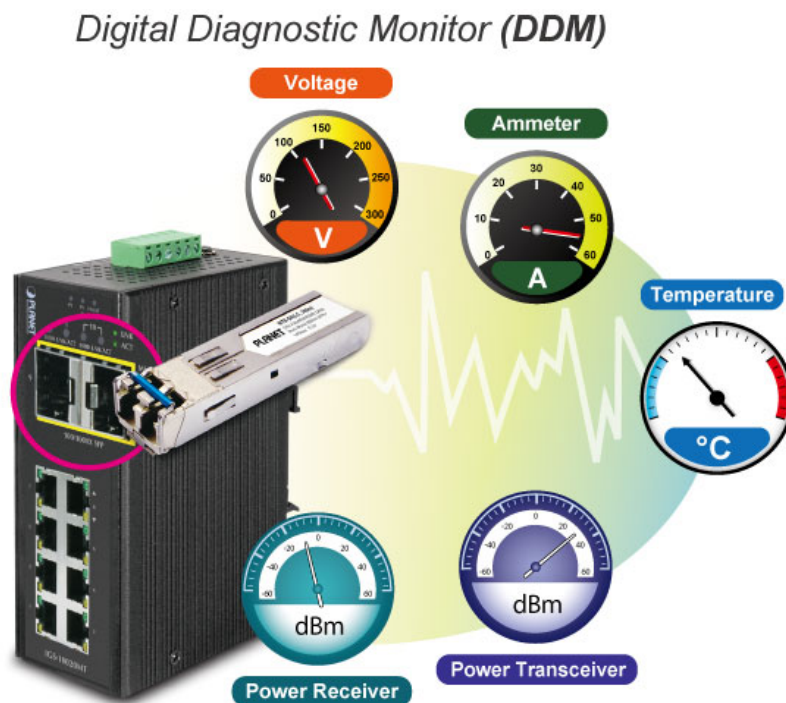

Flexibility and Extension Solution

The two mini-GBIC slots built in the IGS-10020MT support Dual-Speed, **100Base-FX** and **1000Base-SX/LX SFP** (Small Form-factor Pluggable) fiber-optic modules, meaning the administrator now can flexibly choose the suitable SFP transceiver according to the transmission distance or the transmission speed required.

1.3 How to Use This Manual

This User Manual is structured as follows:

Section 2 INSTALLATION

The section explains the functions of the **Industrial Managed Switch** and how to physically install the **Industrial Managed Switch**.

Section 3 SWITCH MANAGEMENT

The section contains the information about the software function of the **Industrial Managed Switch**.

Section 4 WEB CONFIGURATION

The section explains how to manage the **Industrial Managed Switch** by Web interface.

Section 5 COMMAND LINE INTERFACE

The section describes how to use the Command Line interface (CLI).

Section 6 CLI MODE

The section explains how to manage the **Industrial Managed Switch** by Command Line interface.

Section 7 SWITCH OPERATION

The chapter explains how to do the switch operation of the **Industrial Managed Switch**.

Section 8 TROUBLESHOOTING

The chapter explains how to troubleshoot the **Industrial Managed Switch**.

Appendix A

The section contains cable information of the **Industrial Managed Switch**.

Appendix B

The section contains Glossary information of the **Industrial Managed Switch**.

1.4 Product Features

➤ Physical Port

- 8-Port 10/100/1000Base-T RJ-45 copper
- 2 100/1000Base-X mini-GBIC/SFP slots, SFP type auto detection

➤ Industrial Case / Installation

- IP30 Aluminum case protection
- DIN-Rail and Wall Mount Design
- Redundant Power Design
 - 12 to 48V DC, redundant power with polarity reverse protect function
 - AC 24V power adapter acceptable
- Supports EFT protection 6000 VDC for power line
- Supports 6000 VDC Ethernet ESD protection
- -40 to 75 degrees C operating temperature

➤ Layer 2 Features

- Prevents packet loss with back pressure (Half-Duplex) and IEEE 802.3x PAUSE frame flow control (Full-Duplex)
- High performance of Store-and-Forward architecture and runt/CRC filtering eliminates erroneous packets to optimize the network bandwidth
- Storm Control support:
 - Multicast / Unknown-Unicast
- Supports **VLAN**
 - IEEE 802.1Q Tagged VLAN
 - Up to 255 VLANs groups, out of 4095 VLAN IDs
 - Provider Bridging (VLAN Q-in-Q) support (IEEE 802.1ad)
 - Private VLAN Edge (PVE)
 - Protocol-based VLAN
 - MAC-based VLAN
 - Voice VLAN
- Supports **Spanning Tree Protocol**
 - STP, IEEE 802.1D Spanning Tree Protocol
 - RSTP, IEEE 802.1w Rapid Spanning Tree Protocol
 - MSTP, IEEE 802.1s Multiple Spanning Tree Protocol, spanning tree by VLAN
 - BPDU Guard
- Supports **Link Aggregation**
 - 802.3ad Link Aggregation Control Protocol (LACP)
 - Cisco ether-channel (Static Trunk)
 - Maximum 5 trunk groups, up to 10 ports per trunk group
 - Up to 20Gbps bandwidth(Duplex Mode)
- Provides Port Mirror (many-to-1)
- Port Mirroring to monitor the incoming or outgoing traffic on a particular port
- Supports E.R.P.S. (**Ethernet Ring Protection Switching**)

➤ Quality of Service

- Ingress Shaper and Egress Rate Limit per port bandwidth control

- 8 priority queues on all switch ports
- Traffic classification:
 - IEEE 802.1p CoS
 - IP TOS / DSCP / IP Precedence
 - IP TCP/UDP port number
 - Typical network application
- Strict priority and Weighted Round Robin (WRR) CoS policies
- Supports QoS and In/Out bandwidth control on each port
- Traffic-policing policies on the switch port
- DSCP remarking

➤ **Multicast**

- Supports IGMP Snooping v1, v2 and v3
- Supports MLD Snooping v1 and v2
- Querier mode support
- IGMP Snooping port filtering
- MLD Snooping port filtering
- MVR (Multicast VLAN Registration)

➤ **Security**

- IEEE 802.1x Port-Based / MAC-Based network access authentication
- Build-in RADIUS client to co-operate with the RADIUS servers
- TACACS+ login users access authentication
- RADIUS / TACACS+ users access authentication
- IP-Based Access Control List (ACL)
- MAC-Based Access Control List
- Source MAC / IP address binding
- **DHCP Snooping** to filter untrusted DHCP messages
- **Dynamic ARP Inspection** discards ARP packets with invalid MAC address to IP address binding
- **IP Source Guard** prevents IP spoofing attacks
- Auto DoS rule to defend DoS attack
- IP address access management to prevent unauthorized intruder

➤ **Management**

- Switch Management Interfaces
 - Web switch management
 - Remote Telnet management
 - SNMP v1, v2c, and v3 switch management
 - SSH / SSL secure access
- Four RMON groups (history, statistics, alarms, and events)
- **IPv6** IP Address / NTP / DNS management
- Built-in Trivial File Transfer Protocol (TFTP) client
- BOOTP and DHCP for IP address assignment
- Firmware upload/download via HTTP / TFTP
- DHCP Relay
- DHCP Option82

- User Privilege levels control
- NTP (Network Time Protocol)
- Link Layer Discovery Protocol (LLDP) Protocol
- Cable Diagnostic technology provides the mechanism to detect and report potential cabling issues
- Reset button for system reboot or reset to factory default
- PLANET Smart Discovery Utility for deploy management

1.5 Product Specifications

Model Name	IGS-10020MT	
Hardware Specification		
Copper Ports	8 10/ 100/1000Base-T RJ-45 Auto-MDI/MDI-X ports	
SFP/mini-GBIC Slots	2 1000Base-SX/LX/BX SFP interfaces (Port-9 and Port-10) Compatible with 100Base-FX SFP	
Switch Architecture	Store-and-Forward	
Switch Fabric	20Gbps / non-blocking	
Throughput (packet per second)	14.8Mpps	
Address Table	8K entries, automatic source address learning and ageing	
Share data Buffer	512 kilobytes	
Flow Control	IEEE 802.3x Pause Frame for Full-Duplex. Back pressure for Half-Duplex	
Jumbo Frame	9Kbytes	
Reset Button	< 5 sec: System reboot > 5 sec: Factory Default	
ESD Protection	6KV DC	
EFT Protection	6KV DC	
Enclosure	IP30 Aluminum Metal Case	
Installation	DIN Rail Kit and Wall Mount Kit	
Alarm	One relay output for power failure. Alarm Relay current carry ability: 1A @ DC 24V	
LED Indicator	System: Power 1 (Green) Power 2 (Green) Fault Alarm (Green) Ring (Green) R.O. (Green)	Per 10/100/1000T RJ-45 Ports: LNK/ACT (Green) 1000 (Orange) Per SFP Interface: LNK/ACT (Green) 1000 (Orange)
Dimensions (W x D x H)	87.8 x 135 x 56mm	
Weight	720g	
Power Requirements	DC 12 to 48V. AC 24V Power Adapter	
Power Consumption	10 Watts / 34BTU (Full loading)	
Layer 2 function		
Basic Management Interfaces	Web Browser, Remote Telnet, SNMPv1, v2c	
Secure Management Interface	SSH, SSL, SNMP v3	
Port configuration	Port disable/enable Auto-negotiation 10/100/1000Mbps full and half duplex mode selection Flow Control disable / enable Power saving mode control	
Port Status	Display each port's speed duplex mode, link status, Flow control status. Auto negotiation status, trunk status.	
Port Mirroring	TX / RX / Both Many to 1 monitor	
VLAN	802.1Q Tagged Based VLAN ,up to 255 VLAN groups Q-in-Q tunneling Private VLAN Edge (PVE) MAC-based VLAN Protocol-based VLAN Voice VLAN MVR (Multicast VLAN Registration) Up to 255 VLAN groups, out of 4095 VLAN IDs	
Link Aggregation	IEEE 802.3ad LACP / Static Trunk Support 5 groups of 10-Port trunk support	
QoS	Traffic classification based, Strict priority and WRR 8-level priority for switching - Port Number - 802.1p priority	

	- 802.1Q VLAN tag - DSCP/TOS field in IP Packet
IGMP Snooping	IGMP (v1/v2/V3) Snooping, up to 255 multicast Groups IGMP Querier mode support
MLD Snooping	MLD (v1/v2) Snooping, up to 255 multicast Groups MLD Querier mode support
Access Control List	IP-Based ACL / MAC-Based ACL Up to 123 entries
Bandwidth Control	Per port bandwidth control Ingress: 500Kb~80Mbps Egress: 64Kb~80Mbps
SNMP MIBs	RFC-1213 MIB-II IF-MIB RFC-1493 Bridge MIB RFC-1643 Ethernet MIB RFC-2863 Interface MIB RFC-2665 Ether-Like MIB RFC-2819 RMON MIB (Group 1, 2, 3 and 9) RFC-2737 Entity MIB RFC-2618 RADIUS Client MIB RFC-2933 IGMP-STD-MIB RFC3411 SNMP-Frameworks-MIB IEEE 802.1X PAE LLDP MAU-MIB
Standards Conformance	
Regulation Compliance	FCC Part 15 Class A, CE
Stability Testing	IEC60068-2-32 (Free fall) IEC60068-2-27 (Shock) IEC60068-2-6 (Vibration)
Standards Compliance	IEEE 802.3 10Base-T IEEE 802.3u 100Base-TX / 100Base-FX IEEE 802.3z Gigabit SX/LX IEEE 802.3ab Gigabit 1000T IEEE 802.3x Flow Control and Back pressure IEEE 802.3ad Port trunk with LACP IEEE 802.1D Spanning Tree Protocol IEEE 802.1w Rapid Spanning Tree Protocol IEEE 802.1s Multiple Spanning Tree Protocol IEEE 802.1p Class of service IEEE 802.1Q VLAN Tagging IEEE 802.1x Port Authentication Network Control IEEE 802.1ab LLDP RFC 768 UDP RFC 793 TFTP RFC 791 IP RFC 792 ICMP RFC 2068 HTTP RFC 1112 IGMP version 1 RFC 2236 IGMP version 2 RFC 3376 IGMP version 3 RFC 2710 MLD version 1 FRC 3810 MLD version 2
Environment	
Operating	Temperature: -40 ~ 75 degrees C Relative Humidity: 5 ~ 95% (Non-condensing)
Storage	Temperature: -40 ~ 75 degrees C Relative Humidity: 5 ~ 95% (Non-condensing)

2. INSTALLATION

2.1 Hardware Description

The Industrial Managed Switch provides three different running speeds – 10Mbps, 100Mbps and 1000Mbps in the same Switch and automatically distinguishes the speed of incoming connection.

This section describes the hardware features of Industrial Managed Switch. For easier management and control of the Industrial Managed Switch, familiarize yourself with its display indicators, and ports. Front panel illustrations in this chapter display the unit LED indicators. Before connecting any network device to the Industrial Managed Switch, read this chapter carefully.

2.1.1 Physical Dimensions

- Dimensions (W x D x H) : 87.8 x 135 x 56mm

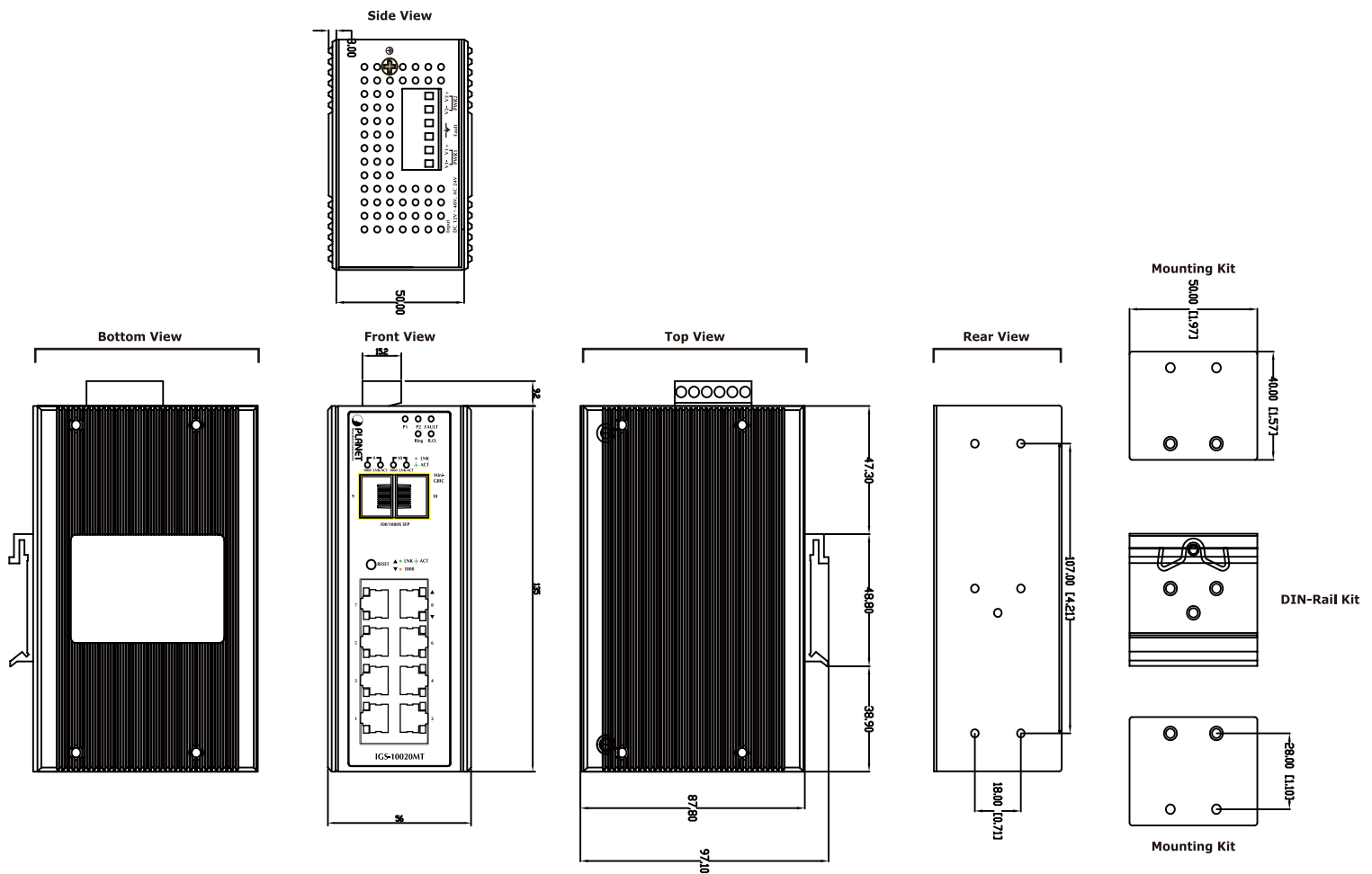

Dimensions (unit = mm)

2.1.2 Front Panel

Figure 2-1 shows the front panel of Industrial Managed Switch.

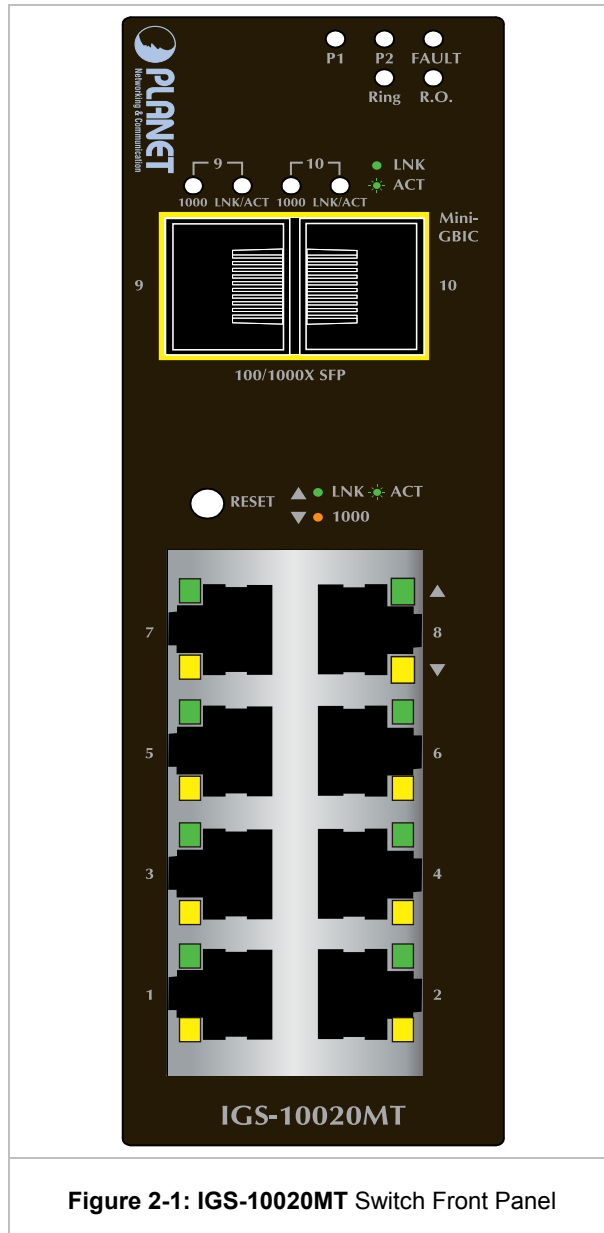

Figure 2-1: IGS-10020MT Switch Front Panel

■ **Reset Button**

On the left of the front panel, the reset button is designed for rebooting the **Industrial Managed Switch** without turning off and on the power. It also can reset the **Industrial Managed Switch** to factory default mode.

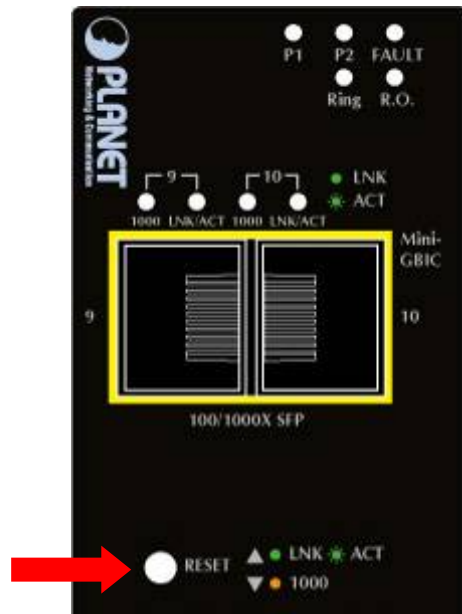

Figure 2-2: Reset Button of Industrial Managed Switch

Reset Button Pressed and Released	Function
< 5 sec: System Reboot	Reboot the Industrial Managed Switch
> 5 sec: Factory Default	Reset the Industrial Managed Switch to Factory Default configuration. The Industrial Managed Switch will then reboot and load the default settings as below: <ul style="list-style-type: none"> ■ Default Username: admin ■ Default Password: admin ■ Default IP address: 192.168.0.100 ■ Subnet mask: 255.255.255.0 ■ Default Gateway: 192.168.0.254

2.1.3 LED Indicators

■ **System**

LED	Color	Function
P1	Green	Indicates power 1 has power.
P2	Green	Indicates power 2 has power.
Fault	Green	Indicates either power 1 or power 2 has no power.

Ring	Green	Lights to indicate that the ERPS Ring has been created successfully.
R.O.*	Green	Lights to indicate that Switch has enabled Ring Owner.

■ Per 10/100/1000Base-T Port

LED	Color	Function	
LNK / ACT	Green	Light	Indicates the link through that port is successfully established.
		Blink	Indicates that the Switch is actively sending or receiving data over that port.
1000	Orange	Light	Indicates that the port is successfully connecting to the network at 1000Mbps.
		Off	Indicates that the port is successfully connecting to the network at 10Mbps or 100Mbps.

■ Per SFP Interface

LED	Color	Function	
LNK / ACT	Green	Light	Indicates the link through that port is successfully established.
		Blink	Indicates that the Switch is actively sending or receiving data over that port.
1000	Orange	Light	Indicates that the port is successfully connecting to the network at 1000Mbps.
		Off	Indicates that the port is successfully connecting to the network at 100Mbps.

2.1.4 Switch Upper Panel

The Upper Panel of the **Industrial Managed Switch** indicates a DC inlet power socket and consists of one terminal block connector within 6-contacts. It accepts input power from 12 to 48V DC, and also AC 24V.

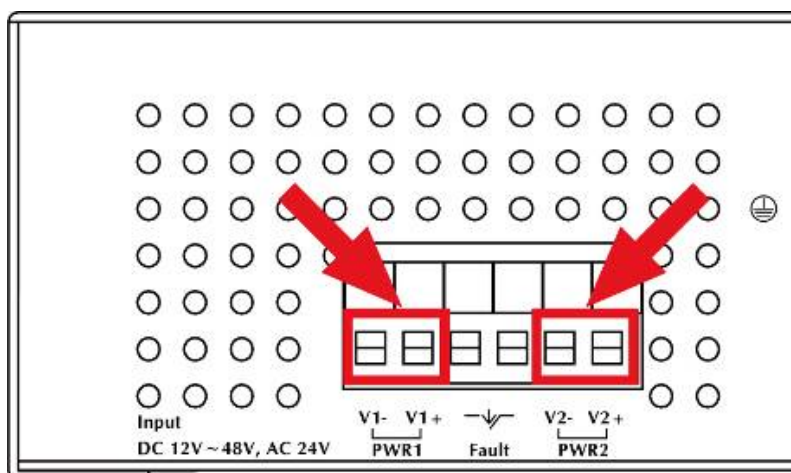

Figure 2-3: IGS-10020MT Upper Panel

2.2 Installing Industrial Managed Switch

This section describes how to install your **Industrial Managed Switch** and make connections to the **Industrial Managed Switch**. Please read the following topics and perform the procedures in the order being presented. To install your **Industrial Managed Switch** on a desktop or shelf, simply complete the following steps.

In this paragraph, we will describe how to install the **Industrial Managed Switch** and the installation points attended to it.

2.2.1 Installation Steps

1. **Unpack the Industrial Managed Switch**
2. **Check if the DIN-Rail is screwed on the Industrial Managed Switch or not.** If the DIN-Rail is not screwed on the **Industrial Managed Switch**, please refer to **DIN-Rail Mounting** section for DIN-Rail installation. If users want to wall-mount the **Industrial Managed Switch**, please refer to the **Wall Mount Plate Mounting** section for wall mount plate installation.
3. **To hang the Industrial Managed Switch on the DIN-Rail track or wall.**
4. **Power on the Industrial Managed Switch.** Please refer to the **Wiring the Power Inputs** section for knowing the information about how to wire the power. The power LED on the **Industrial Managed Switch** will light up. Please refer to the **LED Indicators** section for indication of LED lights.
5. **Prepare the twisted-pair, straight through Category 5 cable for Ethernet connection.**
6. **Insert one side of RJ-45 cable (category 5) into the Industrial Managed Switch Ethernet port** (RJ-45 port) and the other side of RJ-45 cable (category 5) to the network device's Ethernet port (RJ-45 port), e.g. Switch PC or Server. The UTP port (RJ-45) LED on the **Industrial Managed Switch** will light up when the cable is connected with the network device. Please refer to the **LED Indicators** section for LED light indication.



Make sure that the connected network devices support MDI/MDI-X. If it does not support, use the crossover category-5 cable.

7. **When all connections are set and LED lights all show normally, the installation is completed.**

2.2.2 DIN-Rail Mounting

This section describes how to install the **Industrial Managed Switch**.

There are two methods to install the **Industrial Managed Switch**. DIN-Rail Mounting and Wall Mount Plate Mounting. Please read the following topics and perform the procedures in the order being presented.

Step 1: Screw the DIN-Rail on the **Industrial Managed Switch**.



Step 2: Lightly press the bottom of DIN-Rail into the track.



Step 3: Check the DIN-Rail is tightly on the track.



Please refer to following procedures to remove the **Industrial Managed Switch** from the track.

Step 4: Lightly press the bottom of DIN-Rail to remove it from the track.



2.2.3 Wall Mount Plate Mounting

To install the **Industrial Managed Switch** on the wall. Please follow the instructions below.

Step 1: Remove the DIN-Rail from the **Industrial Managed Switch**. Use the screwdriver to loosen the screws and remove the DIN-Rail.

Step 2: Place the wall mount plate on the rear panel of the **Industrial Managed Switch**.



Step 3: Use the screwdriver to screw the wall mount plate on the **Industrial Managed Switch**.

Step 4: Use the hook holes at the corners of the wall mount plate to hang the **Industrial Managed Switch** on the wall.

Step 5: To remove the wall mount plate, reverse the steps above.

2.3 Wiring the Power Inputs

The 6-contacts terminal block connector on the top panel of **Industrial Managed Switch** is used for two DC redundant power inputs. Please follow the steps to insert the power wire. The PWR1 is 1(-) & 2(+) and PWR2 is 5(-) & 6(+) contact.

Remember: Tighten the wire-clamp screws for preventing the wires from loosening..

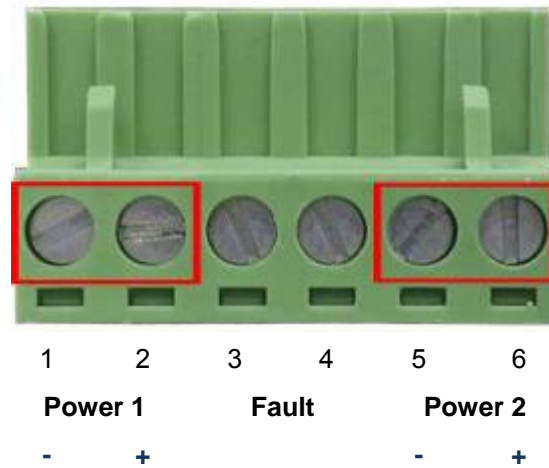

Figure 2-4: 6-Contacts of Terminal Block Connector



1. The wire gauge for the terminal block should be in the range of 12 ~ 24 AWG.
2. Follow any of the procedures like inserting the wires or tighten the wire-clamp screws. Ensure the power is OFF to prevent from getting an electric shock.

2.4 Wiring the Fault Alarm Contact

The fault alarm contacts are in the middle (3 & 4) of the terminal block connector as the picture shows below. Inserting the wires, the **Industrial Managed Switch** will detect the fault status of the power failure, or port link failure (available for managed model).

The following illustration shows an application example for wiring the fault alarm contacts

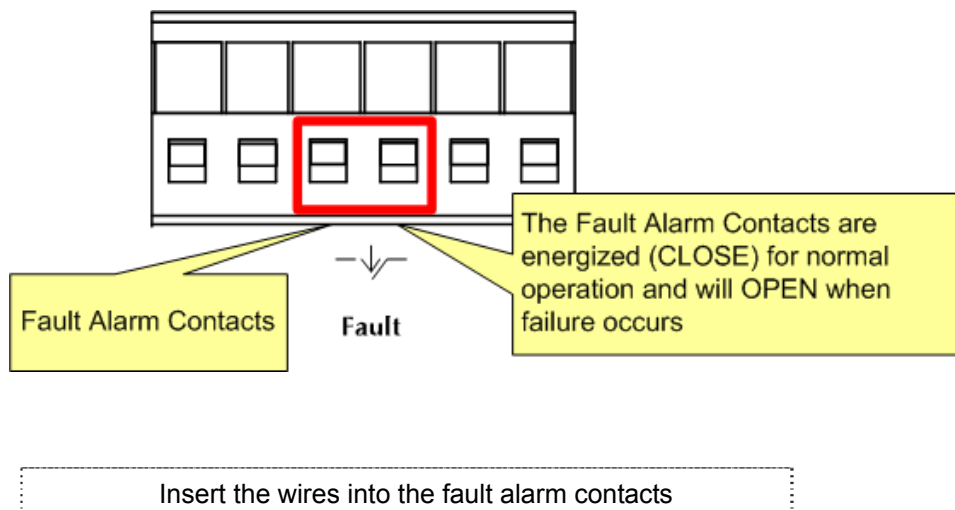



1. The wire gauge for the terminal block should be in the range of 12 ~ 24 AWG.
2. Follow any of the procedures like inserting the wires or tighten the wire-clamp screws. Ensure the power is OFF to prevent to get an electric shock.

2.5 Cabling

■ 10/100/1000Base-T and 100Base-FX / 1000Base-SX/LX

All 10/100/1000Base-T ports come with Auto-Negotiation capability. They automatically support 1000Base-T, 100Base-TX and 10Base-T networks. Users only need to plug a working network device into one of the 10/100/1000Base-T ports, and then turn on the **Industrial Managed Switch**. The port will automatically runs in 10Mbps, 20Mbps, 100Mbps or 200Mbps and 1000Mbps or 2000Mbps after the negotiation with the connected device.

The **Industrial Managed Switch** has two SFP interfaces that support 100/1000 dual speed mode (Optional Multi-mode / Single-mode 100Base-FX / 1000Base-SX/LX SFP module)

■ Cabling

Each 10/100/1000Base-T port uses RJ-45 sockets -- similar to phone jacks -- for connection of unshielded twisted-pair cable (UTP). The IEEE 802.3 / 802.3u 802.3ab Fast / Gigabit Ethernet standard requires Category 5 UTP for 100Mbps 100Base-TX. 10Base-T networks can use Cat.3, 4, 5 or 1000Base-T use 5/5e/6 UTP (see table below). Maximum distance is 100meters (328 feet). The 100Base-FX / 1000Base-SX/LX SFP slot is used as LC connector with optional SFP module.

Please see table below and know more about the cable specifications.

Port Type	Cable Type	Connector
10Base-T	Cat 3, 4, 5, 2-pair	RJ-45
100Base-TX	Cat.5 UTP, 2-pair	RJ-45
1000Base-T	Cat.5/5e/6 UTP, 2-pair	RJ-45
100Base-FX	50 / 125µm or 62.5 / 125µm multi-mode 9 / 125µm single-mode	LC (Multi / Single mode)
1000Base-SX/LX	50 / 125µm or 62.5 / 125µm multi-mode 9 / 125µm single-mode	LC (Multi / Single mode)

Any Ethernet devices like hubs/ PCs can connect to the **Industrial Managed Switch** by using straight-through wires. The eight-10/100/1000Mbps ports are auto-MDI/MDI-X and can be used on straight-through or crossover cable.

2.5.1 Installing the SFP Transceiver

The sections describe how to insert an SFP transceiver into an SFP slot.

The SFP transceivers are hot-pluggable and hot-swappable. You can plug-in and out the transceiver to/from any SFP port without having to power down the **Industrial Managed Switch** as the [Figure 2-5](#) shows.



Figure 2-5: Plug-in the SFP Transceiver

■ Approved PLANET SFP Transceivers

PLANET **Industrial Managed Switch** supports 100/1000 dual mode with both Single mode and Multi-mode SFP transceiver. The following list of approved PLANET SFP transceivers is correct at the time of publication:

Gigabit SFP Transceiver Modules

MGB-GT	SFP-Port 1000Base-T Module
MGB-SX	SFP-Port 1000Base-SX mini-GBIC module
MGB-LX	SFP-Port 1000Base-LX mini-GBIC module
MGB-L30	SFP-Port 1000Base-LX mini-GBIC module-30km
MGB-L50	SFP-Port 1000Base-LX mini-GBIC module-50km
MGB-L70	SFP-Port 1000Base-LX mini-GBIC module-70km
MGB-L120	SFP-Port 1000Base-LX mini-GBIC module-120km
MGB-LA10	SFP-Port 1000Base-LX (WDM, TX:1310nm) mini-GBIC module-10km
MGB-LB10	SFP-Port 1000Base-LX (WDM, TX:1550nm) mini-GBIC module-10km
MGB-LA20	SFP-Port 1000Base-LX (WDM, TX:1310nm) mini-GBIC module-20km
MGB-LB20	SFP-Port 1000Base-LX (WDM, TX:1550nm) mini-GBIC module-20km
MGB-LA40	SFP-Port 1000Base-LX (WDM, TX:1310nm) mini-GBIC module-40km
MGB-LB40	SFP-Port 1000Base-LX (WDM, TX:1550nm) mini-GBIC module-40km

MGB-TSX	SFP-Port 1000Base-SX mini-GBIC module - 550m (-40~75°C)
MGB-TLX	SFP-Port 1000Base-LX mini-GBIC module - 10km (-40~75°C)
MGB-TL30	SFP-Port 1000Base-LX mini-GBIC module - 30km (-40~75°C)
MGB-TL70	SFP-Port 1000Base-LX mini-GBIC module - 70km (-40~75°C)

Fast Ethernet SFP Transceiver Modules

MFB-FX	SFP-Port 100Base-FX Transceiver (1310nm)-2km
MFB-F20	SFP-Port 100Base-FX Transceiver (1310nm)-20km
MFB-F40	SFP-Port 100Base-FX Transceiver (1310nm)-40km
MFB-F60	SFP-Port 100Base-FX Transceiver (1310nm)-60km
MFB-FA20	SFP-Port 100Base-BX Transceiver (WDM,TX:1310nm)-20km
MFB-FB20	SFP-Port 100Base-BX Transceiver (WDM,TX:1550nm)-20km
MFB-TFX	SFP-Port 100Base-FX Transceiver (1310nm) -2km (-40~75°C)
MFB-TF20	SFP-Port 100Base-FX Transceiver (1310nm) - 20km (-40~75°C)



It is recommended to use PLANET SFPs on the **Industrial Managed Switch**. If you insert an SFP transceiver that is not supported, the **Industrial Managed Switch** will not recognize it.

1000Base-SX/LX:

Before connecting the other switches, workstation or media converter,

1. Make sure both sides of the SFP transceiver are with the same media type; for example, 1000Base-SX to 1000Base-SX, 1000Bas-LX to 1000Base-LX.
2. Check the fiber-optic cable type that matches the SFP transceiver model.
 - To connect to 1000Base-SX SFP transceiver, use the Multi-mode fiber cable with one side being male duplex LC connector type.
 - To connect to 1000Base-LX SFP transceiver, use the Single-mode fiber cable with one side being male duplex LC connector type.

Connecting the fiber cable

1. Attach the duplex LC connector to the network cable and put into the SFP transceiver.
2. Connect the other end of the cable to a device – switches with SFP installed, fiber NIC to a workstation or a media converter.
3. Check the LNK/ACT LED of the SFP slot on the front of the **Industrial Managed Switch**. Make sure that the SFP transceiver is operating correctly.

100Base-FX:

Before connecting the other switches, workstation or media converter,

1. Make sure both sides of the SFP transceiver are with the same media type or WDM pair, for example: 100Base-FX to

100Base-FX, 100Base-BX20-U to 100Base-BX20-D.

2. Check the fiber-optic cable type that matches the SFP transceiver model.
 - To connect to 1000Base-SX SFP transceiver, use the Multi-mode fiber cable with one side being male duplex LC connector type.
 - To connect to 1000Base-LX SFP transceiver, use the Single-mode fiber cable with one side being male duplex LC connector type.

Connecting the fiber cable

- 1 Attach the duplex LC connector to the network cable and put into the SFP transceiver.
- 2 Connect the other end of the cable to a device – switches with SFP installed, fiber NIC to a workstation or a media converter.
3. Check the LNK/ACT LED of the SFP slot on the front of the **Industrial Managed Switch**. Make sure that the SFP transceiver is operating correctly.
4. Check the Link mode of the SFP port if the link failed. Co works with some fiber-NICs or Media Converters, set the Link mode to “**100 Force**” is needed.

2.5.2 Removing the Module

1. Make sure there is no network activity by consulting or checking with the network administrator. Or through the management interface of the switch/converter (if available) to disable the port in advance.
2. Remove the Fiber Optic Cable gently.
3. Turn the handle of the MGB / MFB module to horizontal.
4. Pull out the module gently through the lever..



Figure 2-6: Pull Out the SFP Transceiver Module



Never pull out the module without pulling the lever or the push bolts on the module. Directly pulling out the module with force could damage the module and SFP module slot of the device.

3. SWITCH MANAGEMENT

This chapter explains the methods that you can use to configure management access to the **Industrial Managed Switch**. It describes the types of management applications and the communication and management protocols that deliver data between your management device (workstation or personal computer) and the system. It also contains information about port connection options.

This chapter covers the following topics:

- Requirements
- Management Access Overview
- Remote Telnet Access
- Web Management Access
- SNMP Access
- Standards, Protocols, and Related Reading

3.1 Requirements

- Workstations running Windows XP/2003, Vista, Windows 7, MAC OS X, Linux, Fedora, Ubuntu or other platforms compatible with **TCP/IP** protocols.
- **Workstation** is installed with **Ethernet NIC** (Network Interface Card)
- Ethernet Port connection
 - Network cables - Use standard network (UTP) cables with RJ45 connectors.
 - The above workstation is installed with **WEB Browser** and **JAVA runtime environment** Plug-in



It is recommended to use Internet Explore 7.0 or above to access **Industrial Managed Switch**.

3.2 Management Access Overview

The **Industrial Managed Switch** gives you the flexibility to access and manage it using any or all of the following methods:

- Remote Telnet Interface
- **Web browser** Interface
- An external **SNMP-based network management application**

The Remote Telnet and Web browser interface support is embedded in the **Industrial Managed Switch** software and is available for immediate use. Each of these management methods has their own advantages. Table 3-1 compares the three management methods.

Method	Advantages	Disadvantages
Remote Telnet	<ul style="list-style-type: none"> • Text-based • Telnet functionality built into Windows XP/2003, Vista, Windows 7 operating systems • Can be accessed from any location 	<ul style="list-style-type: none"> • Security can be compromised (hackers need only know the IP address)
Web Browser	<ul style="list-style-type: none"> • Ideal for configuring the switch remotely • Compatible with all popular browsers • Can be accessed from any location • Most visually appealing 	<ul style="list-style-type: none"> • Security can be compromised (hackers need only know the IP address and subnet mask) • May encounter lag times on poor connections
SNMP Agent	<ul style="list-style-type: none"> • Communicates with switch functions at the MIB level • Based on open standards 	<ul style="list-style-type: none"> • Requires SNMP manager software • Least visually appealing of all three methods • Some settings require calculations • Security can be compromised (hackers need only know the community name)

Table 3-1: Management Methods Comparison

3.3 Remote Telnet

The Remote Telnet is an IP-based command line user interface for performing system administration such as displaying statistics or changing option settings. Using this method, you can access the **Industrial Managed Switch** remote telnet interface from personal computer, or workstation in the same Ethernet environment as long as you know the current IP address of the **Industrial Managed Switch**.

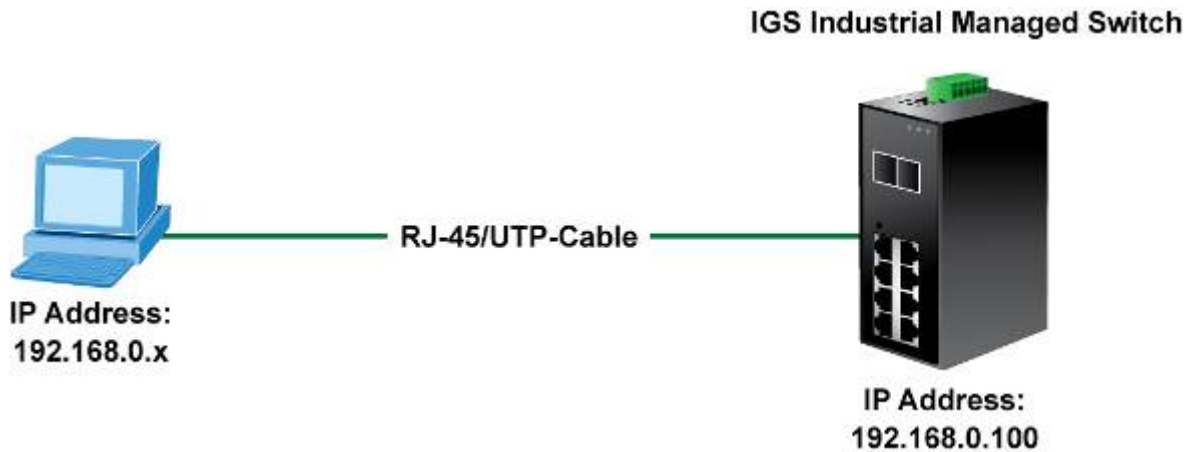

Figure 3-1: Remote Telnet Interface Management

In Windows system, you may click **“Start”** and then choose **“Accessories”** and **“Command Prompt”**. Please input **“telnet 192.168.0.100”** and press **“enter”** from your keyboard. You will see the following screen appear:

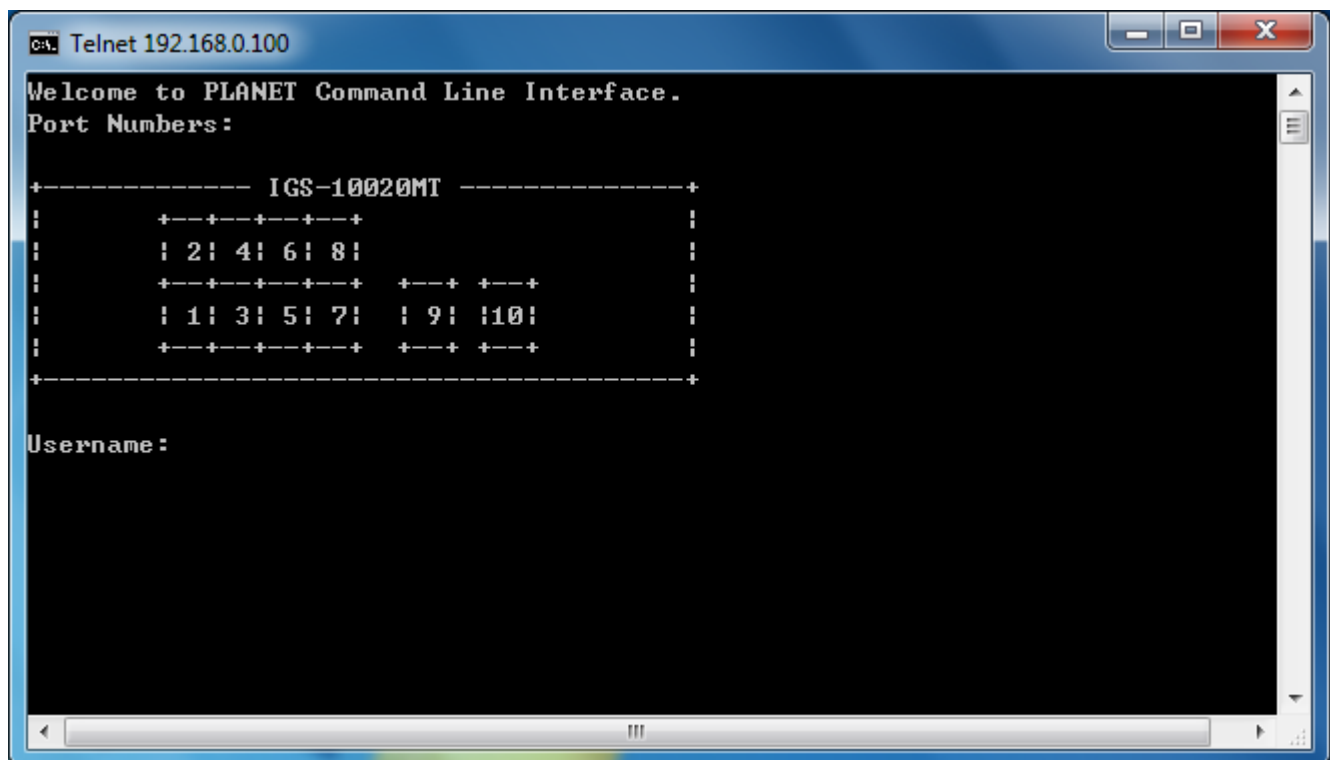

Figure 3-2: Remote Telnet Interface Main Screen of Industrial Managed Switch

For more information about using the Remote Telnet interface, refer to **Chapter 5 Remote Telnet Interface Management**.

3.4 Web Management

The **Industrial Managed Switch** offers management features that allow users to manage the **Industrial Managed Switch** from anywhere on the network through a standard browser such as Microsoft Internet Explorer. After you set up your IP address for the **Industrial Managed Switch**, you can access the **Industrial Managed Switch's** Web interface applications directly in your Web browser by entering the IP address of the **Industrial Managed Switch**.

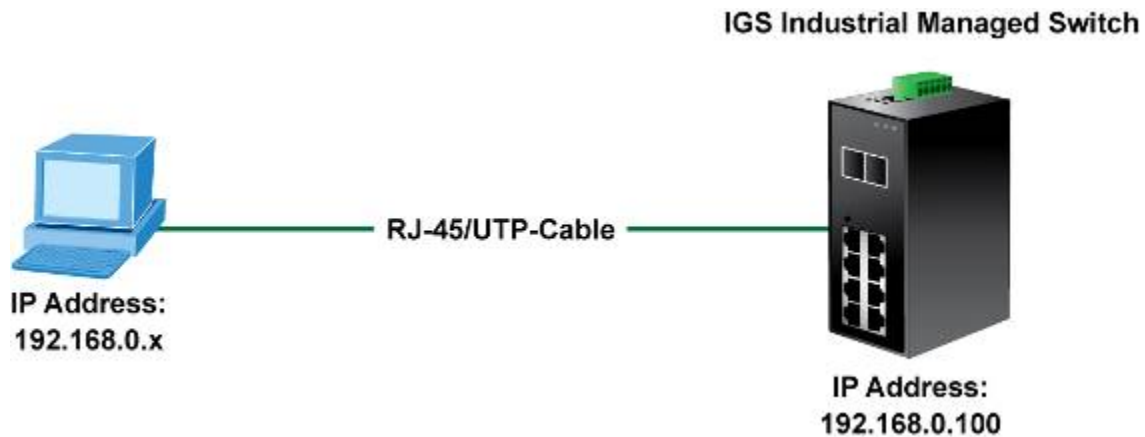

Figure 3-3: Web Management

You can then use your Web browser to list and manage the **Industrial Managed Switch** configuration parameters from one central location; the Web Management requires either **Microsoft Internet Explorer 7.0** or later, **Safari** or **Mozilla Firefox 1.5** or later.



Figure 3-4: Web Main Screen of Industrial Managed Switch

3.5 SNMP-Based Network Management

You can use an external SNMP-based application to configure and manage the **Industrial Managed Switch**, such as SNMP Network Manager, HP Openview Network Node Management (NNM) or What's Up Gold. This management method requires the SNMP agent on the **Industrial Managed Switch** and the SNMP Network Management Station to use the **same community string**. This management method, in fact, uses two community strings: the **get community string** and the **set community string**. If the SNMP Network management Station only knows the set community string, it can read and write to the MIBs. However, if it only knows the get community string, it can only read MIBs. The default gets and sets community strings for the **Industrial Managed Switch** are public.

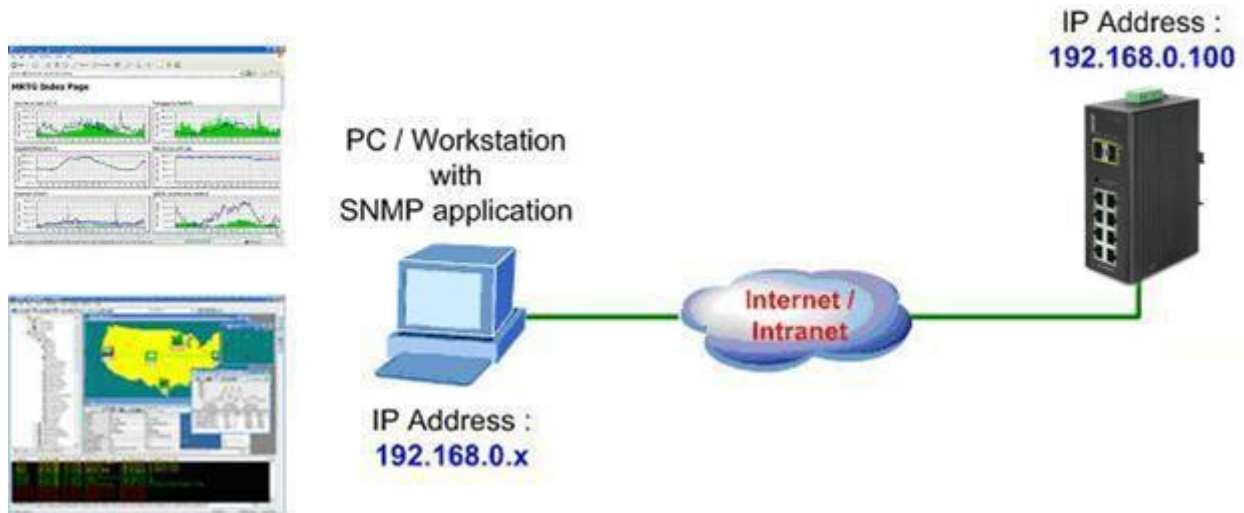

Figure 3-5: SNMP Management

3.6 PLANET Smart Discovery Utility

To easily list the **Industrial Managed Switch** in your Ethernet environment, Planet Smart Discovery Utility from user's manual CD-ROM is an ideal solution. The following installation instructions guide you to running Planet Smart Discovery Utility.

1. Deposit the Planet Smart Discovery Utility in administrator PC.
2. Run this utility and the following screen appears.

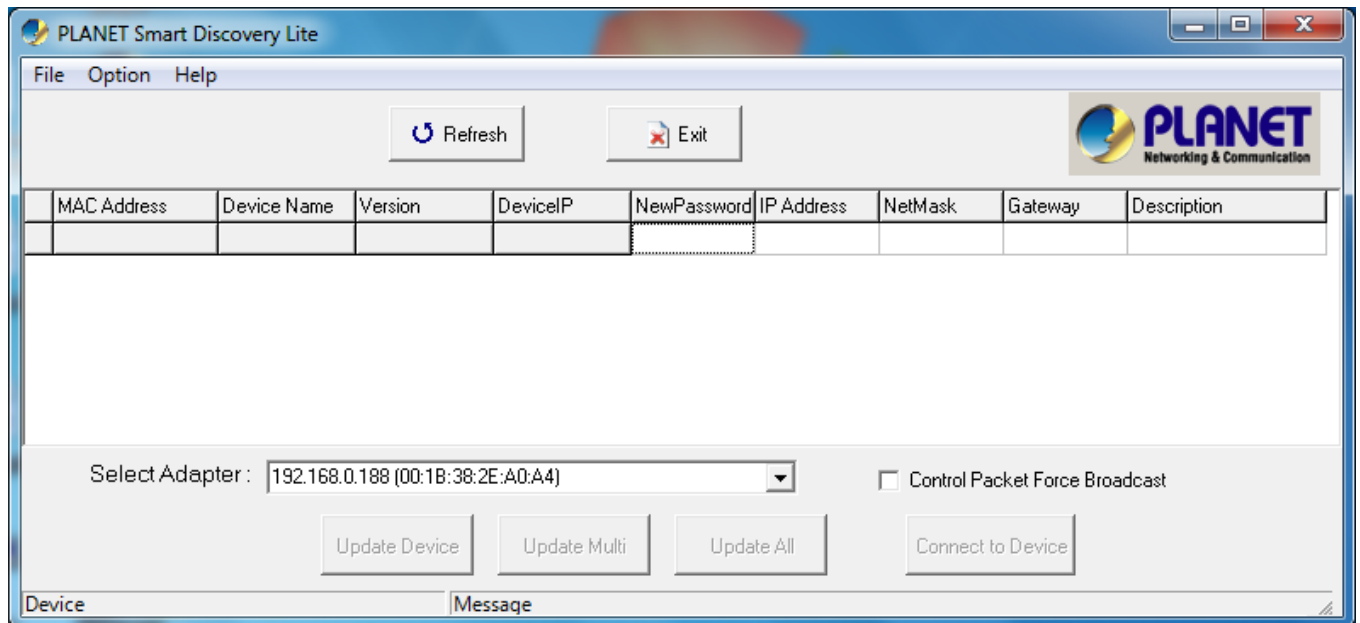

Figure 3-6: Planet Smart Discovery Utility Screen



If there are two LAN cards or above in the same administrator PC, choose a different LAN card by using the **“Select Adapter”** tool.

3. Press **“Refresh”** button for the current connected devices in the discovery list and the screen is shown as follows:

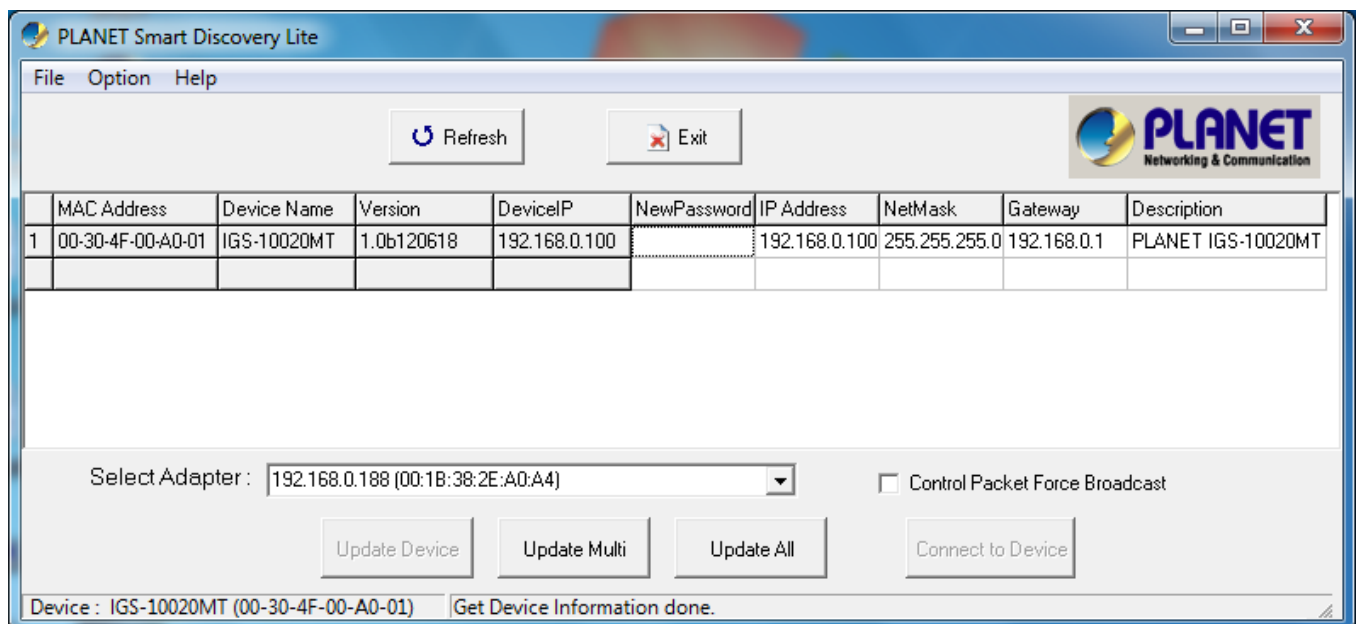

Figure 3-7: Planet Smart Discovery Utility Screen

1. This utility shows all necessary information from the devices, such as MAC Address, Device Name, firmware version, and Device IP Subnet address. It also can assign new password, IP Subnet address and description for the devices.
2. After setup is completed, press "**Update Device**", "**Update Multi**" or "**Update All**" button to take effect. The purposes of the above 3 buttons are shown below:
 - **Update Device**: use current setting on one single device.
 - **Update Multi**: use current setting on multi-devices.
 - **Update All**: use current setting on whole devices in the list.

The same functions mentioned above also can be found in "**Option**" tools bar.

3. To click the "**Control Packet Force Broadcast**" function, it can assign new setting value to the Web Smart Switch under a different IP subnet address.
4. Press "**Connect to Device**" button and then the Web login screen appears in [Figure 3-4](#).
5. Press "**Exit**" button to shut down Planet Smart Discovery Utility.

4. WEB CONFIGURATION

This section introduces the configuration and functions of the Web-based management.

About Web-based Management

The Industrial Managed Switch offers management features that allow users to manage the Industrial Managed Switch from anywhere on the network through a standard browser such as Microsoft Internet Explorer.

The Web-based Management supports Internet Explorer 7.0. It is based on Java Applets with an aim to reduce network bandwidth consumption, enhance access speed and present an easy viewing screen.



By default, IE7.0 or later version does not allow Java Applets to open sockets. The user has to explicitly modify the browser setting to enable Java Applets to use network ports.

The Industrial Managed Switch can be configured through an Ethernet connection, making sure the manager PC must be set on the same the IP subnet address as the Industrial Managed Switch.

For example, the default IP address of the Industrial Managed Switch is **192.168.0.100**, then the manager PC should be set at **192.168.0.x** (where x is a number between 1 and 254, except 100), and the default subnet mask is 255.255.255.0.

If you have changed the default IP address of the Industrial Managed Switch to 192.168.1.1 with subnet mask 255.255.255.0 via console, then the manager PC should be set at 192.168.1.x (where x is a number between 2 and 254) to do the relative configuration on manager PC.

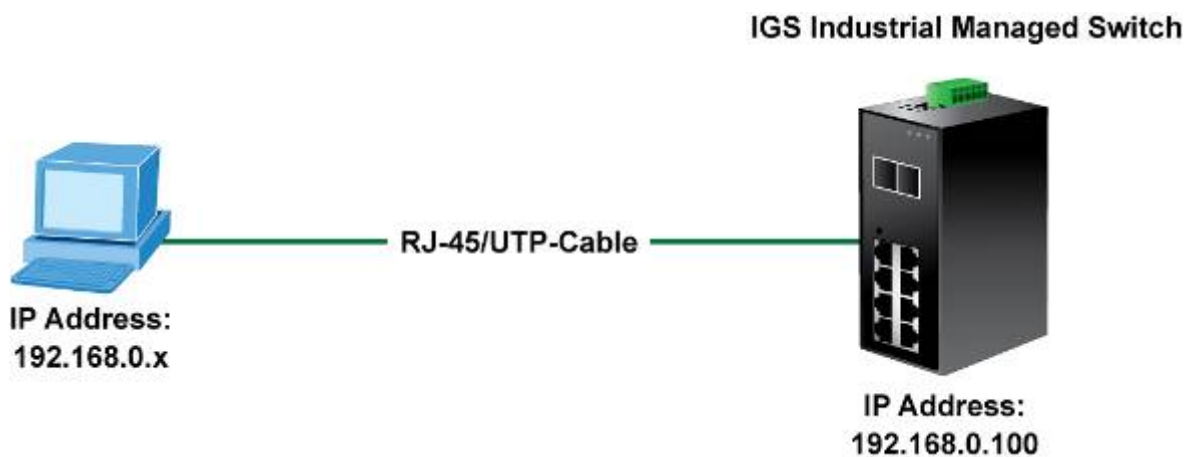

Figure 4-1-1: Web Management

■ **Logging on the Industrial Managed Switch**

1. Use Internet Explorer 7.0 or above Web browser and enter the factory-default IP address to access the Web interface.
The factory-default IP Address is as follows:

http://192.168.0.100

2. When the following login screen appears, please enter the default username "**admin**" with password "**admin**" (or the username/password you have changed via console) to login the main screen of Industrial Managed Switch. The login screen in [Figure 4-1-2](#) appears.



Figure 4-1-2: Login Screen

Default User name: **admin**

Default Password: **admin**

After entering the username and password, the main screen appears as [Figure 4-1-3](#).



Figure 4-1-3: Default Main Page

Now, you can use the Web management interface to continue the switch management or manage the Industrial Managed Switch by Web interface. The Switch Menu on the left of the web page let you access all the commands and statistics the Managed Switch provides.



1. It is recommended to use Internet Explorer 7.0 or above to access Industrial Managed Switch.
2. The changed IP address take effect immediately after clicking on the **Save** button. You need to use the new IP address to access the Web interface.
3. For security reason, please change and memorize the new password after this first setup.
4. Only accept command in lowercase letter under web interface.

4.1 Main Web Page

The Industrial Managed Switch provides a Web-based browser interface for configuring and managing it. This interface allows you to access the Industrial Managed Switch using the Web browser of your choice. This chapter describes how to use the Industrial Managed Switch's Web browser interface to configure and manage it.

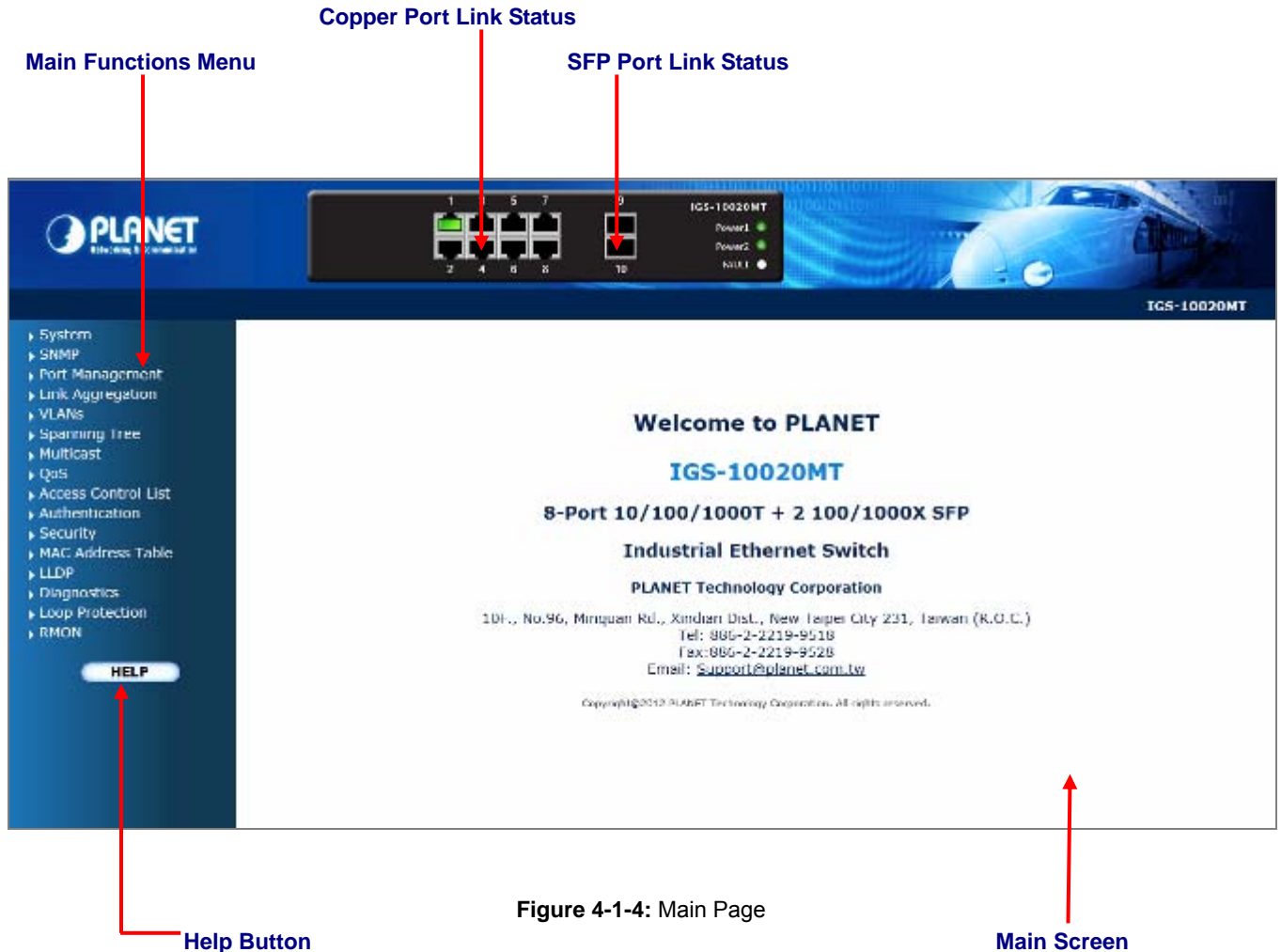

Figure 4-1-4: Main Page

Panel Display

The web agent displays an image of the Industrial Managed Switch's ports. The Mode can be set to display different information for the ports, including Link up or Link down. Clicking on the image of a port opens the **Port Statistics** page.

The port status is illustrated as follows:

State	Disabled	Down	Link
RJ-45 Ports			
SFP Ports			

Main Menu

Using the onboard web agent, you can define system parameters, manage and control the Industrial Managed Switch, and all its ports, or monitor network conditions. Via the Web-Management, the administrator can set up the Industrial Managed Switch by selecting the functions those listed in the Main Function. The screen in [Figure 4-1-5](#) appears.

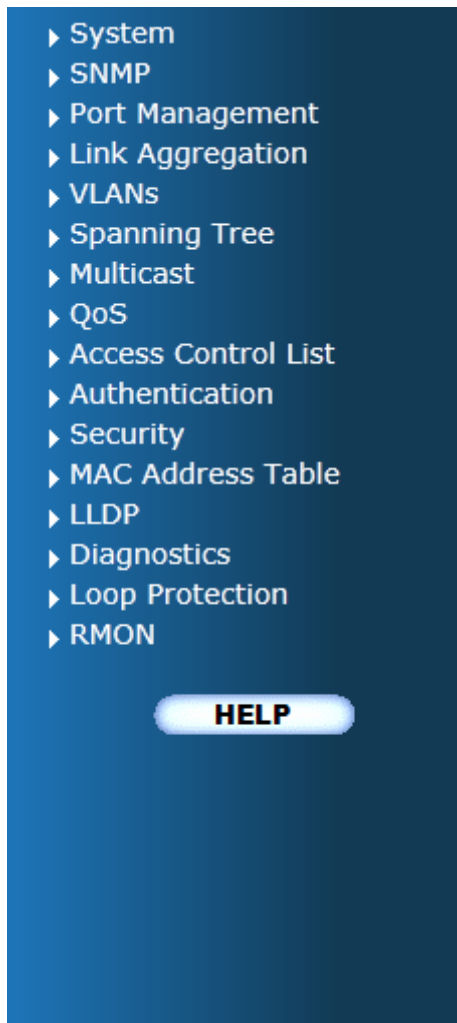

Figure 4-1-5: Industrial Managed Switch Main Functions Menu

4.2 System

Use the System menu items to display and configure basic administrative details of the Industrial Managed Switch. Under the System, the following topics are provided to configure and view the system information: This section has the following items:

- **System Information** The switch system information is provided here.
- **IP Configuration** Configure the switch-managed IP information on this page.
- **IPv6 Configuration** Configure the switch-managed IPv6 information on this page.
- **Users Configuration** This page provides an overview of the current users. Currently the only way to login as another user on the web server is to close and reopen the browser.

- **Privilege Levels** This page provides an overview of the privilege levels.
- **NTP Configuration** Configure NTP on this page.
- **UPnP** Configure UPnP on this page.
- **DHCP Relay** Configure DHCP Relay on this page.
- **DHCP Relay Statistics** This page provides statistics for DHCP relay.
- **CPU Load** This page displays the CPU load, using a SVG graph.
- **System Log** The switch system log information is provided here.
- **Detailed Log** The switch system detailed log information is provided here.
- **Remote Syslog** Configure remote syslog on this page.
- **SMTP Configuration** Configure SMTP function on this page.
- **EEE Power Reduction** Configuration energy efficient ethernet power reduction on this page
- **Thermal Protection** Configure thermal protection on this page.
- **Web Firmware Upgrade** This page facilitates an update of the firmware controlling the switch.
- **TFTP Firmware Upgrade** Upgrade the firmware via TFTP server
- **Configuration Backup** You can save the switch configuration. The configuration file is in XML format with a hierarchy of tags.

- **Configuration Upload** You can load the switch configuration. The configuration file is in XML format with a hierarchy of tags.

- **Image Select** Configuration active or alternate firmware on this page.
- **Factory Default** You can reset the configuration of the switch on this page. Only the IP configuration is retained.

- **System Reboot** You can restart the switch on this page. After restart, the switch will boot normally.

4.2.1 System Information

The System Info page provides information for the current device information. System Info page helps a switch administrator to identify the hardware MAC address, software version and system uptime. The screen in [Figure 4-2-1](#) appears.

System Information

System	
Contact Name	IGS-10020MT
Location	
Hardware	
MAC Address	00-30-4f-00-a0-01
Power	POWER1 ON POWER2 ON
Time	
System Date	1970-01-01 Thu 01:22:19+00:00
System Uptime	0d 01:22:19
Software	
Software Version	1.0b120618
Software Date	2012-06-18T10:43:11+0800

Auto-refresh

Figure 4-2-1: System Information Page Screenshot

The page includes the following fields:

Object	Description
• Contact	The system contact is configured in Configuration System Information System Contact.
• Name	The system name is configured in Configuration System Information System Name.
• Location	The system location is configured in Configuration System Information System Location.
• MAC Address	The MAC Address of this Industrial Managed Switch.
• Power	The Power 1 and Power 2 ON/OFF Status display.
• Temperature	The Temperature shows the current temperature status of the switch
• System Date	The current (GMT) system time and date. The system time is obtained through the configured SNTP Server, if any.
• System Uptime	The period of time the device has been operational.
• Software Version	The software version of the Industrial Managed Switch.
• Software Date	The date when the switch software was produced.

Buttons

Auto-refresh : Check this box to refresh the page automatically. Automatic refresh occurs every 3 seconds.

Refresh: Click to refresh the page.

4.2.2 IP Configuration

The IP Configuration includes the IP Address, Subnet Mask and Gateway. The Configured column is used to view or change the IP configuration. Fill out the IP Address, Subnet Mask and Gateway for the device. The screen in [Figure 4-2-2](#) appears.

IP Configuration

	Configured	Current
DHCP Client	<input type="checkbox"/>	Renew
IP Address	192.168.0.100	192.168.0.100
IP Mask	255.255.255.0	255.255.255.0
IP Router	192.168.0.1	192.168.0.1
VLAN ID	1	1
DNS Server	0.0.0.0	0.0.0.0

IP DNS Proxy Configuration

DNS Proxy

Save **Reset**

Figure 4-2-2: IP Configuration Page Screenshot

The current column is used to show the active IP configuration.

Object	Description
• DHCP Client	Enable the DHCP client by checking this box. If DHCP fails and the configured IP address is zero, DHCP will retry. If DHCP server does not respond around 35 seconds and the configured IP address is non-zero, DHCP will stop and the configured IP settings will be used. The DHCP client will announce the configured System Name as host name to provide DNS lookup.
• IP Address	Provide the IP address of this switch in dotted decimal notation.
• IP Mask	Provide the IP mask of this switch dotted decimal notation.
• IP Router	Provide the IP address of the router in dotted decimal notation.
• VLAN ID	Provide the managed VLAN ID. The allowed range is 1 through 4095 .
• DNS Server	Provide the IP address of the DNS Server in dotted decimal notation.
• DNS Proxy	When DNS proxy is enabled, DUT will relay DNS requests to the current configured DNS server on DUT, and reply as a DNS resolver to the client device on the network.

Buttons

Save: Click to save changes.

Reset: Click to undo any changes made locally and revert to previously saved values.

Renew: Click to renew DHCP Client. This button is only available if DHCP Client is enabled.

4.2.3 IPv6 Configuration

Configure the switch-managed IPv6 information on this page.

The Configured column is used to view or change the IPv6 configuration. The Current column is used to show the active IPv6 configuration. The screen in [Figure 4-2-3](#) appears.

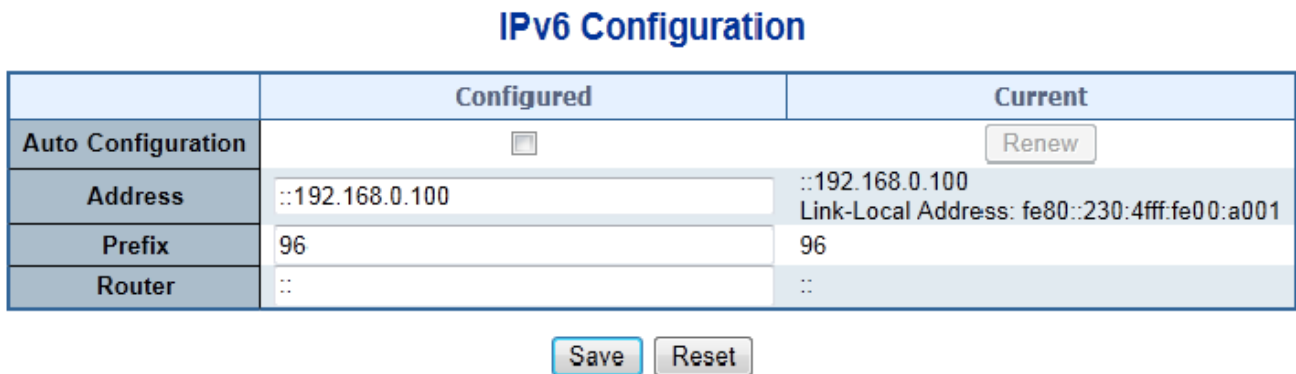

Figure 4-2-3: IPv6 Configuration Page Screenshot

The page includes the following fields:

Object	Description
<ul style="list-style-type: none"> Auto Configuration 	Enable IPv6 auto-configuration by checking this box. If system cannot obtain the stateless address in time, the configured IPv6 settings will be used. The router may delay responding to a router solicitation for a few seconds. The total time needed to complete auto-configuration can be significantly longer.
<ul style="list-style-type: none"> Address 	Provide the IPv6 address of this switch. IPv6 address is in 128-bit records represented as eight fields of up to four hexadecimal digits with a colon separating each field (:). For example, 'fe80::215:c5ff:fe03:4dc7'. The symbol '::' is a special syntax that can be used as a shorthand way of representing multiple 16-bit groups of contiguous zeros; but it can appear only once. It can also represent a legally valid IPv4 address. For example, '::192.1.2.34'.
<ul style="list-style-type: none"> Prefix 	Provide the IPv6 Prefix of this switch. The allowed range is 1 to 128 .
<ul style="list-style-type: none"> Router 	Provide the IPv6 gateway address of this switch. IPv6 address is in 128-bit records represented as eight fields of up to four hexadecimal digits with a colon separating each field (:). For example, 'fe80::215:c5ff:fe03:4dc7'. The symbol '::' is a special syntax that can be used as a shorthand way of representing multiple 16-bit groups of contiguous zeros; but it can appear only once. It can also represent a legally valid

	IPv4 address. . For example, ':::192.1.2.34'.
--	---

Buttons

- : Click to save changes.
- : Click to undo any changes made locally and revert to previously saved values.
- : Click to renew IPv6 Auto Configuration. This button is only available if IPv6 Auto Configuration is enabled.

4.2.4 Users Configuration

This page provides an overview of the current users. Currently the only way to login as another user on the web server is to close and reopen the browser. After setup is completed, please press “**Save**” button to take effect. Please login web interface with new user name and password, the screen in [Figure 4-2-4](#) appears.



Figure 4-2-4: Users Configuration Page Screenshot

The page includes the following fields:

Object	Description
• User Name	The name identifies the user.
• Privilege Level	The privilege level of the user. The allowed range is 1 to 15 . If the privilege level value is 15, it can access all groups, i.e. granted the full control of the device. But others value need to refer to each group privilege level. User's privilege should be the same or greater than the group privilege level to have the access to that group. By default setting, almost group privilege level 5 has the read-only access and privilege level 10 has the read-write access. And the system maintenance (software upload, factory defaults, etc.) needs user privilege level 15. Generally, the privilege level 15 can be used for an administrator account, privilege level 10 for a standard user account and privilege level 5 for a guest account.

Buttons

- : Click to add a new user.

Add / Edit User

This page configures a user – add, edit or delete user.

Add User

User Settings	
User Name	<input type="text" value="Test"/>
Password	<input type="password" value="••••"/>
Password (again)	<input type="password" value="••••"/>
Privilege Level	<input type="text" value="1"/> ▼

Figure 4-2-5: Add / Edit User Configuration Page Screenshot

The page includes the following fields:

Object	Description
• User Name	A string identifies the user name whose entry should belong to. The allowed string length is 1 to 32 . The valid user name is a combination of letters, numbers and underscores.
• Password	The password of the user. The allowed string length is 0 to 32 .
• Privilege Level	The privilege level of the user. The allowed range is 1 to 15 . If the privilege level value is 15, it can access all groups, i.e. granted the full control of the device. But others value need to refer to each group privilege level. User's privilege should be same or greater than the group privilege level to have the access to that group. By default setting, most groups privilege level 5 has the read-only access and privilege level 10 has the read-write access. And the system maintenance (software upload, factory defaults and etc.) need user privilege level 15. Generally, the privilege level 15 can be used for an administrator account, privilege level 10 for a standard user account and privilege level 5 for a guest account.

Buttons

- : Click to save changes.
- : Click to undo any changes made locally and revert to previously saved values.
- : Click to undo any changes made locally and return to the Users.
- : Delete the current user. This button is not available for new configurations (Add new user)

Users Configuration

User Name	Privilege Level
admin	15
guest	5
Test	1

Add New User

Figure 4-2-6: User Configuration Page Screenshot



After changing the default password, if you forget the password, please press the "Reset" button on the front panel of the Industrial Managed Switch over 10 seconds and then release. The current setting includes VLAN, and will be lost and the Industrial Managed Switch will restore to the default mode.

4.2.5 Privilege Levels

This page provides an overview of the privilege levels. After setup is completed, please press "**Save**" button to take effect. Please login web interface with new user name and password, the screen in [Figure 4-2-7](#) appears.

Privilege Level Configuration

Group Name	Privilege Levels			
	Configuration Read-only	Configuration/Execute Read/write	Status/Statistics Read-only	Status/Statistics Read/write
Aggregation	5 ▼	10 ▼	5 ▼	10 ▼
Diagnostics	5 ▼	10 ▼	5 ▼	10 ▼
EEE	5 ▼	10 ▼	5 ▼	10 ▼
IP	5 ▼	10 ▼	5 ▼	10 ▼
LACP	5 ▼	10 ▼	5 ▼	10 ▼
LLDP	5 ▼	10 ▼	5 ▼	10 ▼
LLDP_MED	5 ▼	10 ▼	5 ▼	10 ▼
Loop_Protect	5 ▼	10 ▼	5 ▼	10 ▼
MAC_Table	5 ▼	10 ▼	5 ▼	10 ▼
MVR	5 ▼	10 ▼	5 ▼	10 ▼
Maintenance	15 ▼	15 ▼	15 ▼	15 ▼
Mirroring	5 ▼	10 ▼	5 ▼	10 ▼
Multicast	5 ▼	10 ▼	5 ▼	10 ▼
Port_Security	5 ▼	10 ▼	5 ▼	10 ▼
Ports	5 ▼	10 ▼	1 ▼	10 ▼
Private_VLANs	5 ▼	10 ▼	5 ▼	10 ▼
Protocol_based_VLAN	5 ▼	10 ▼	5 ▼	10 ▼
QoS	5 ▼	10 ▼	5 ▼	10 ▼
SNMP	5 ▼	10 ▼	5 ▼	10 ▼
Security	5 ▼	10 ▼	5 ▼	10 ▼
Spanning_Tree	5 ▼	10 ▼	5 ▼	10 ▼
System	5 ▼	10 ▼	1 ▼	10 ▼
Timer	5 ▼	10 ▼	5 ▼	10 ▼
UPnP	5 ▼	10 ▼	5 ▼	10 ▼
VLANs	5 ▼	10 ▼	5 ▼	10 ▼
Voice_VLAN	5 ▼	10 ▼	5 ▼	10 ▼

Figure 4-2-7: Privilege Levels Configuration Page Screenshot

The page includes the following fields:

Object	Description
<ul style="list-style-type: none"> Group Name 	<p>The name identifies the privilege group. In most cases, a privilege level group consists of a single module (e.g. LACP, RSTP or QoS), but a few of them contains more than one. The following description defines these privilege level groups in details:</p> <ul style="list-style-type: none"> ■ System: Contact, Name, Location, Timezone, Log. ■ Security: Authentication, System Access Management, Port (contains Dot1x port, MAC based and the MAC Address Limit), ACL, HTTPS, SSH, ARP Inspection and IP source guard. ■ IP: Everything except 'ping'. ■ Port: Everything except 'VeriPHY'. ■ Diagnostics: 'ping' and 'VeriPHY'. ■ Maintenance: CLI- System Reboot, System Restore Default, System Password, Configuration Save, Configuration Load and Firmware Load. Web-Users, Privilege Levels and everything in Maintenance. ■ Debug: Only present in CLI.
<ul style="list-style-type: none"> Privilege Level 	<p>Every group has an authorization Privilege level for the following sub groups:</p> <ul style="list-style-type: none"> ■ Configuration read-only ■ Configuration/execute read-write ■ Status/statistics read-only ■ Status/statistics read-write (e.g. for clearing of statistics). <p>User Privilege should be the same or greater than the authorization Privilege level to have the access to that group.</p>

Buttons

: Click to save changes.

: Click to undo any changes made locally and revert to previously saved values.

4.2.6 NTP Configuration

Configuring NTP on this page.

NTP is an acronym for **Network Time Protocol**, a network protocol for synchronizing the clocks of computer systems. NTP uses UDP (data grams) as transport layer. You can specify NTP Servers and set GMT Time zone. The NTP Configuration screen in [Figure 4-2-8](#) appears.

NTP Configuration

Mode	Enabled <input type="button" value="v"/>	
Timezone	(GMT+8)Beijing,Chongqing,Hong Kong,Singapore,Taipei <input type="button" value="v"/>	
Server 1	pool.ntp.org	
Server 2	europa.pool.ntp.org	
Server 3	north-america.pool.ntp.org	
Server 4	asia.pool.ntp.org	
Server 5	oceania.pool.ntp.org	

Figure 4-2-8: NTP Configuration Page Screenshot

The page includes the following fields:

Object	Description
<ul style="list-style-type: none"> • Mode 	<p>Indicates the NTP mode operation. Possible modes are:</p> <ul style="list-style-type: none"> ■ Enabled: Enable NTP mode operation. When NTP mode operation is enabled, the agent forwards NTP messages between the clients and the server when they are not on the same subnet domain. ■ Disabled: Disable NTP mode operation.
<ul style="list-style-type: none"> • Timezone 	<p>Allows to select the time zone according to current location of switch.</p>
<ul style="list-style-type: none"> • Server # 	<p>Provide the NTP IPv4 or IPv6 address of this switch. IPv6 address is in 128-bit records represented as eight fields of up to four hexadecimal digits with a colon separating each field (:).</p> <p>For example, 'fe80::215:c5ff:fe03:4dc7'. The symbol '::' is a special syntax that can be used as a shorthand way of representing multiple 16-bit groups of contiguous zeros; but it can appear only once. It can also represent a legally valid IPv4 address. For example, '::192.1.2.34'.</p>

Buttons

: Click to save changes.

: Click to undo any changes made locally and revert to previously saved values.

4.2.7 UPnP

Configure UPnP on this page.

UPnP is an acronym for **Universal Plug and Play**. The goals of UPnP are to allow devices to connect seamlessly and to simplify the implementation of networks in the home (data sharing, communications, and entertainment) and in corporate environments for simplified installation of computer components. The UPnP Configuration screen in [Figure 4-2-9](#) appears.

UPnP Configuration

Mode	Disabled ▾
TTL	4
Advertising Duration	100

Figure 4-2-9: UPnP Configuration Page Screenshot

The page includes the following fields:

Object	Description
<ul style="list-style-type: none"> • Mode 	<p>Indicates the UPnP operation mode. Possible modes are:</p> <ul style="list-style-type: none"> ■ Enabled: Enable UPnP mode operation. ■ Disabled: Disable UPnP mode operation. <p>When the mode is enabled, two ACEs are added automatically to trap UPnP related packets to CPU. The ACEs are automatically removed when the mode is disabled.</p>
<ul style="list-style-type: none"> • TTL 	<p>The TTL value is used by UPnP to send SSDP advertisement messages. Valid values are in the range from 1 to 255.</p>
<ul style="list-style-type: none"> • Advertising Duration 	<p>The duration, carried in SSDP packets, is used to inform a control point or control points about how often it or they should receive an SSDP advertisement message from this switch. If a control point does not receive any message within the duration, it may suggest that the switch no longer exists. Due to the unreliable nature of UDP, as standard it is recommended that such refreshment of advertisements to be done at less than one-half of the advertising duration. In the implementation, the switch sends SSDP messages periodically at the interval one-half of the advertising duration minus 30 seconds. Valid values are in the range from 100 to 86400.</p>

Buttons

: Click to save changes.

: Click to undo any changes made locally and revert to previously saved values.

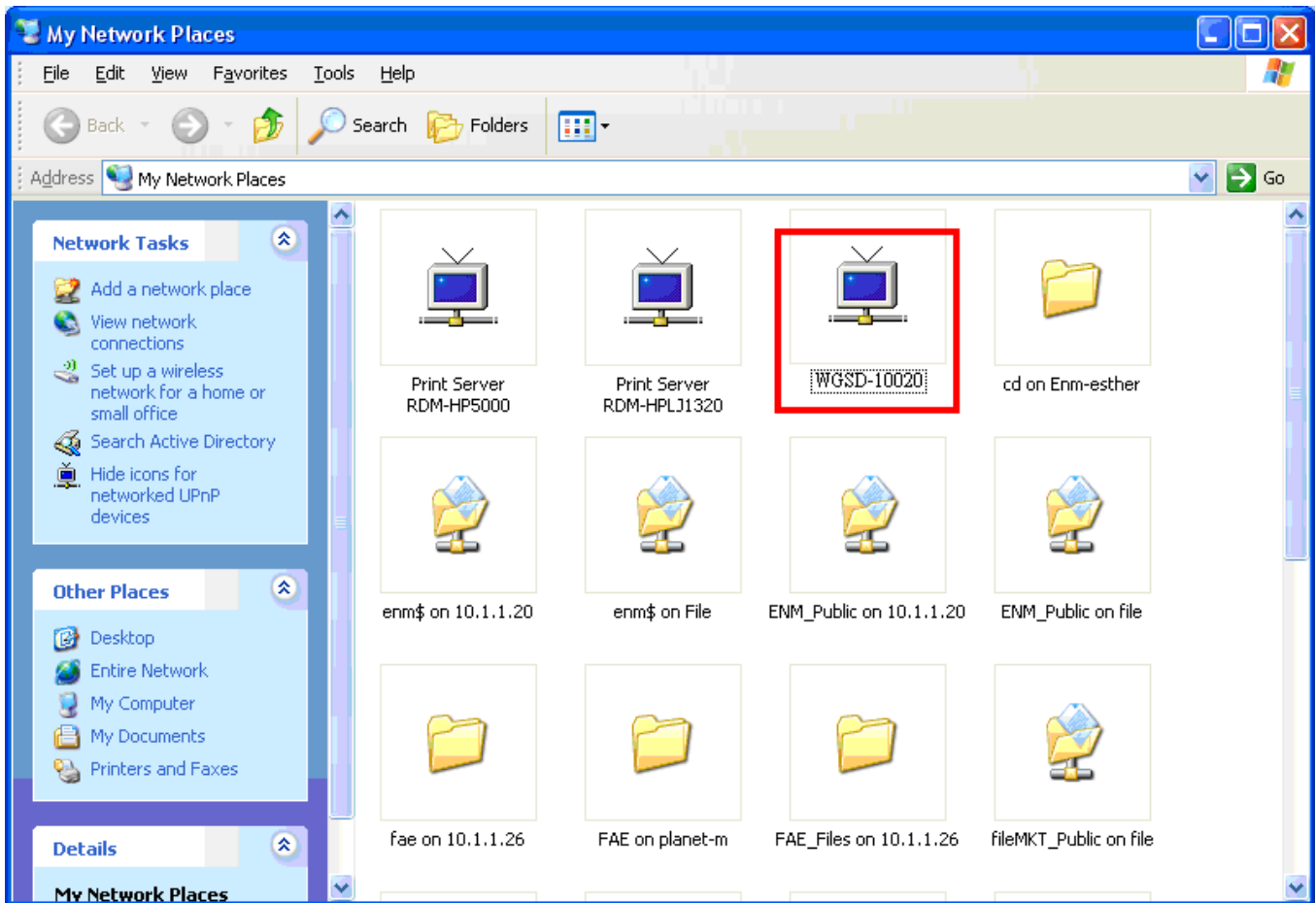

Figure 4-2-10: UPnP Devices shows on Windows My Network Places

4.2.8 DHCP Relay

Configuring DHCP Relay on this page. **DHCP Relay** is used to forward and to transfer DHCP messages between the clients and the server when they are not on the same subnet domain.

The **DHCP option 82** enables a DHCP relay agent to insert specific information into a DHCP request packets when forwarding client DHCP packets to a DHCP server and remove the specific information from a DHCP reply packets when forwarding server DHCP packets to a DHCP client. The DHCP server can use this information to implement IP address or other assignment policies. Specifically the option works by setting two sub-options:

- Circuit ID (option 1)
- Remote ID (option2).

The Circuit ID sub-option is supposed to include information specific to which circuit the request came in on.

The Remote ID sub-option was designed to carry information relating to the remote host end of the circuit.

The definition of Circuit ID in the switch is 4 bytes in length and the format is "vlan_id" "module_id" "port_no". The parameter of "vlan_id" is the first two bytes representing the VLAN ID. The parameter of "module_id" is the third byte for the module ID (in standalone switch it always equals 0; in stackable switch it means switch ID). The parameter of "port_no" is the fourth byte and it means the port number.

The Remote ID is 6 bytes in length, and the value is equal to the DHCP relay agent's MAC address. The DHCP Relay Configuration screen in [Figure 4-2-11](#) appears.

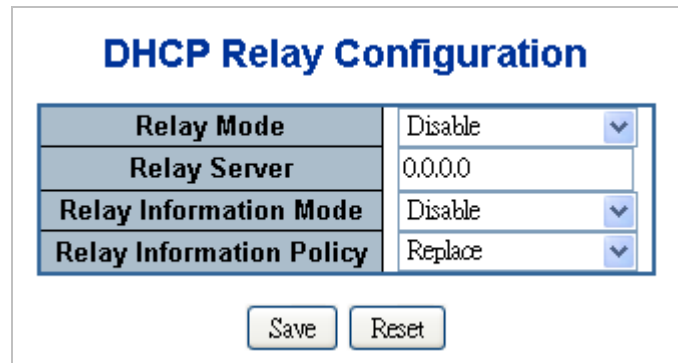

Figure 4-2-11: DHCP Relay Configuration Page Screenshot

The page includes the following fields:

Object	Description
1. Relay Mode	<p>Indicates the DHCP relay mode operation. Possible modes are:</p> <ul style="list-style-type: none"> ■ Enabled: Enable DHCP relay mode operation. When enable DHCP relay mode operation, the agent forward and to transfer DHCP messages between the clients and the server when they are not on the same subnet domain. And the DHCP broadcast message won't flood for security considered. ■ Disabled: Disable DHCP relay mode operation.
2. Relay Server	<p>Indicates the DHCP relay server IP address. A DHCP relay agent is used to forward and to transfer DHCP messages between the clients and the server when they are not on the same subnet domain.</p>
3. Relay Information Mode	<p>Indicates the DHCP relay information mode option operation. Possible modes are:</p> <ul style="list-style-type: none"> ■ Enabled: Enable DHCP relay information mode operation. When enable DHCP relay information mode operation, the agent insert specific information (option82) into a DHCP message when forwarding to DHCP server and remove it from a DHCP message when transferring to DHCP client. It only works under DHCP relay operation mode enabled. ■ Disabled: Disable DHCP relay information mode operation.
4. Relay Information Policy	<p>Indicates the DHCP relay information option policy. When enable DHCP relay information mode operation, if agent receive a DHCP message that already contains relay agent information. It will enforce the policy. And it only works under DHCP relay information operation mode enabled. Possible policies are:</p> <ul style="list-style-type: none"> ■ Replace: Replace the original relay information when receive a DHCP message that already contains it. ■ Keep: Keep the original relay information when receive a DHCP message that already contains it. ■ Drop: Drop the package when receive a DHCP message that already contains relay information.

Buttons

Save: Click to save changes.

Reset: Click to undo any changes made locally and revert to previously saved values.

4.2.9 DHCP Relay Statistics

This page provides statistics for DHCP relay. The DHCP Relay Statistics screen in [Figure 4-2-12](#) appears.

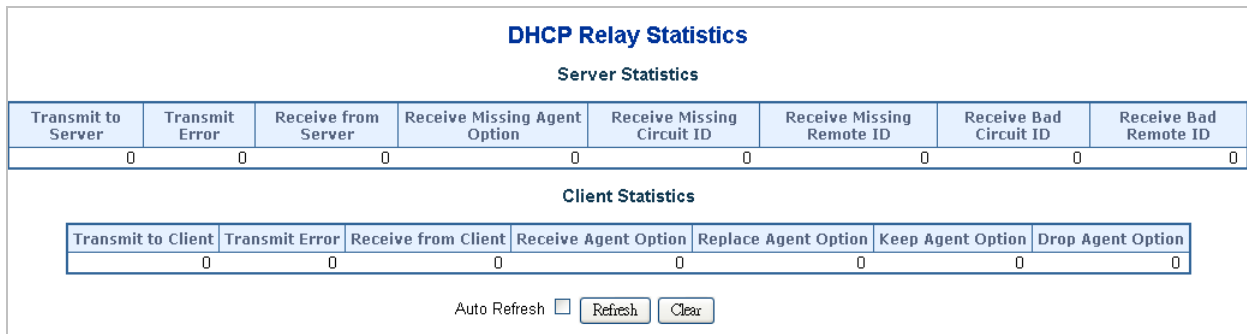

Figure 4-2-12: DHCP Relay Statistics Page Screenshot

The page includes the following fields:

Server Statistics

Object	Description
• Transmit to Server	The number of packets that are relayed from client to server.
• Transmit Error	The number of packets that resulted in errors while being sent to clients.
• Receive form Server	The number of packets received from server.
• Receive Missing Agent Option	The number of packets received without agent information options.
• Receive Missing Circuit ID	The number of packets received with the Circuit ID option missing.
• Receive Missing Remote ID	The number of packets received with the Remote ID option missing.
• Receive Bad Circuit ID	The number of packets whose Circuit ID option did not match known circuit ID.
• Receive Bad Remote ID	The number of packets whose Remote ID option did not match known Remote ID.

Client Statistics

Object	Description
• Transmit to Client	The number of relayed packets from server to client.
• Transmit Error	The number of packets that resulted in error while being sent to servers.

• Receive from Client	The number of received packets from server.
• Receive Agent Option	The number of received packets with relay agent information option.
• Replace Agent Option	The number of packets which were replaced with relay agent information option.
• Keep Agent Optin	The number of packets whose relay agent information was retained.
• Drop Agent Option	The number of packets that was dropped which were received with relay agent information.

Buttons

Auto-refresh : Check this box to refresh the page automatically. Automatic refresh occurs every 3 seconds.

: Click to refresh the page immediately.

: Clear all statistics.

4.2.10 CPU Load

This page displays the CPU load, using a **SVG graph**. The load is measured as averaged over the last 100ms, 1sec and 10 seconds intervals. The last 120 samples are graphed, and the last numbers are displayed as text as well.

In order to display the SVG graph, your browser must support the SVG format. Consult the SVG Wiki for more information on browser support. Specifically, at the time of writing, Microsoft Internet Explorer will need to have a plugin installed to support SVG. The CPU Load screen in [Figure 4-2-13](#) appears.

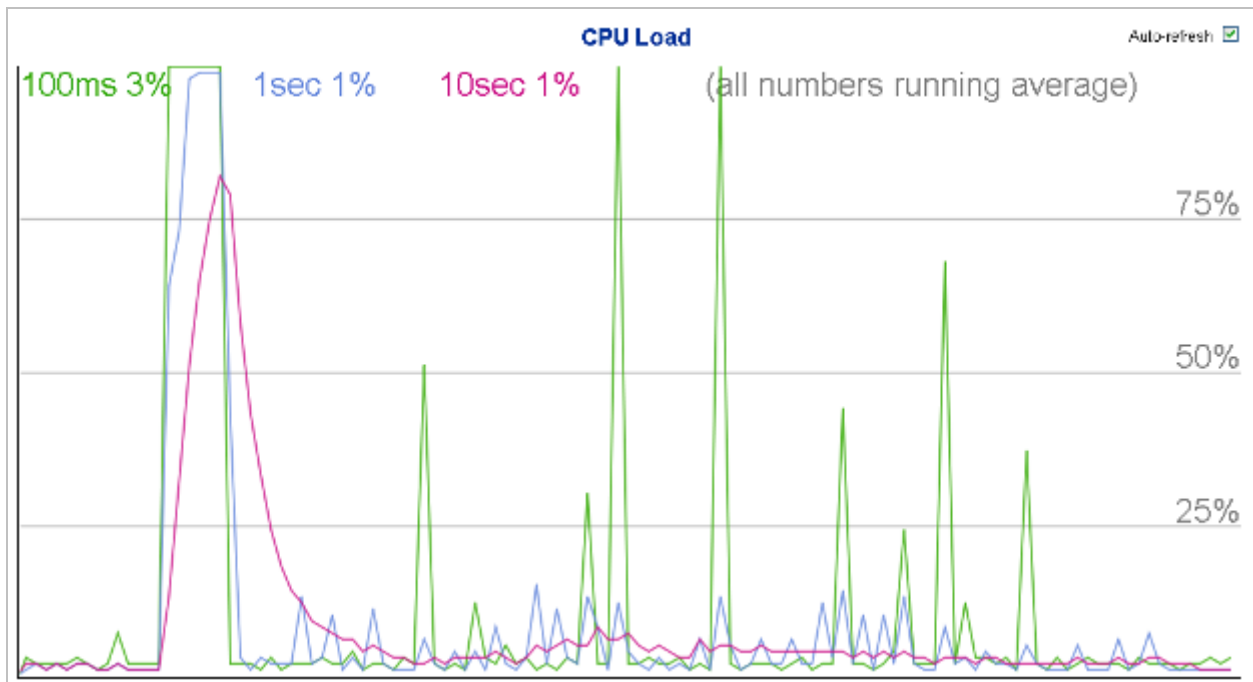

Figure 4-2-13: CPU Load Page Screenshot

Buttons

Auto-refresh : Check this box to refresh the page automatically. Automatic refresh occurs every 3 seconds.



If your browser cannot display anything on this page, please download Adobe SVG tool and install it in your computer.

4.2.11 System Log

The switch system log information is provided here. The System Log screen in [Figure 4-2-14](#) appears.

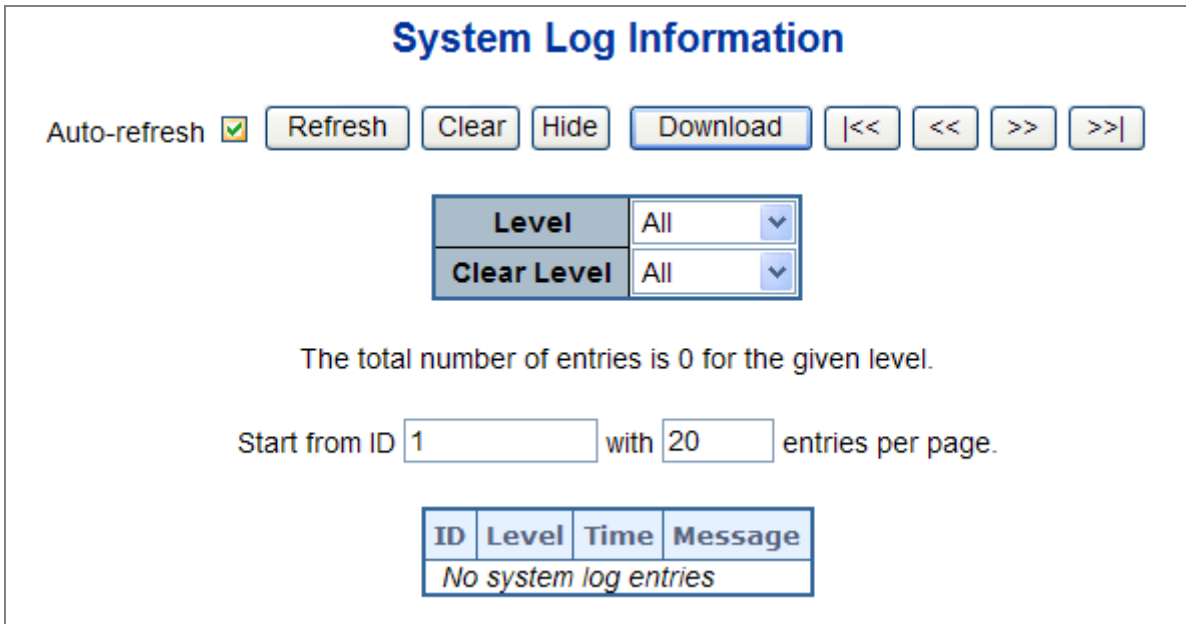

Figure 4-2-14: System Log Page Screenshot

The page includes the following fields:

Object	Description
• ID	The ID (>= 1) of the system log entry.
• Level	The level of the system log entry. The following level types are supported: <ul style="list-style-type: none"> ■ Info: Information level of the system log. ■ Warning: Warning level of the system log. ■ Error: Error level of the system log. ■ All: All levels.
• Time	The time of the system log entry.
• Message	The message of the system log entry.

Buttons

Auto-refresh : Check this box to refresh the page automatically. Automatic refresh occurs every 3 seconds.

: Click to update the system log entries, starting from the current entry ID.

: Flushes the selected log entries.

: Updates the system log entries, starting from the first available entry ID.

: Updates the system log entries, ending at the last entry currently displayed.

: Updates the system log entries, starting from the last entry currently displayed.

: Updates the system log entries, ending at the last available entry ID.

4.2.12 Detailed Log

The switch system detailed log information is provided here. The Detailed Log screen in [Figure 4-2-15](#) appears.

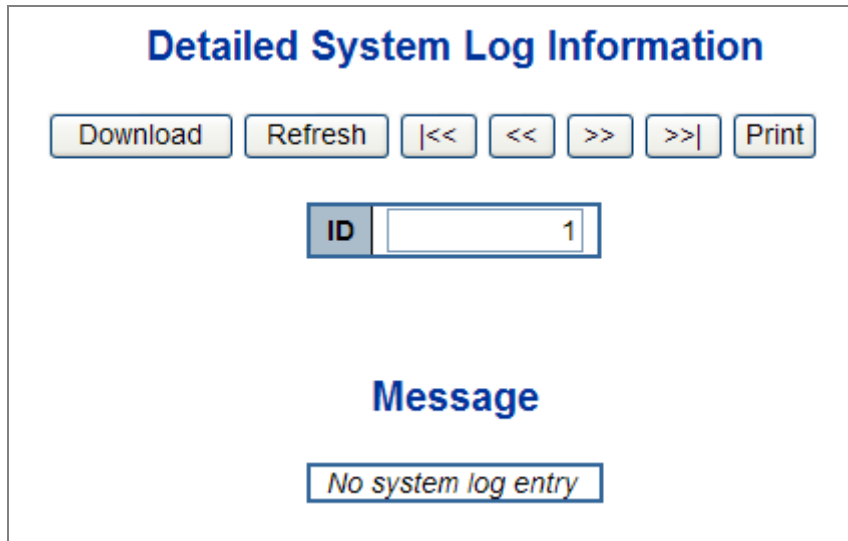

Figure 4-2-15: Detailed Log Page Screenshot

The page includes the following fields:

Object	Description
• ID	The ID (≥ 1) of the system log entry.
• Message	The message of the system log entry.

Buttons

Refresh: Updates the system log entry to the current entry ID.

<<: Updates the system log entry to the first available entry ID

<<: Updates the system log entry to the previous available entry ID.

>>: Updates the system log entry to the next available entry ID.

>>|: Updates the system log entry to the last available entry ID.

4.2.13 Remote Syslog

Configure remote syslog on this page. The Remote Syslog screen in [Figure 4-2-16](#) appears.

Figure 4-2-16: Remote Syslog Page Screenshot

The page includes the following fields:

Object	Description
5. Server Mode	<p>Indicates the server mode operation. When the mode operation is enabled, the syslog message will send out to syslog server. The syslog protocol is based on UDP communication and received on UDP port 514 and the syslog server will not send acknowledgments back sender since UDP is a connectionless protocol and it does not provide acknowledgments. The syslog packet will always send out even if the syslog server does not exist. Possible modes are:</p> <ul style="list-style-type: none"> ■ Enabled: Enable server mode operation. ■ Disabled: Disable server mode operation.
6. Server Address	<p>Indicates the IPv4 host address of syslog server. If the switch provide DNS feature, it also can be a host name.</p>
7. Syslog Level	<p>Indicates what kind of message will send to syslog server. Possible modes are:</p> <ul style="list-style-type: none"> ■ Info: Send information, warnings and errors. ■ Warning: Send warnings and errors. ■ Error: Send errors.

Buttons

Save: Click to save changes.

Reset: Click to undo any changes made locally and revert to previously saved values.

4.2.14 SMTP Configuration

Configure SMTP Configuration on this page. The SMTP Configuration screen in [Figure 4-2-17](#) appears.

sys smtp conf

SMTP Mode	<input type="checkbox"/> Enable
SMTP Server	planet.com.tw (<128 Digits) <input type="button" value="test"/>
SMTP Port	25 (1 ~ 65535)
SMTP Authentication	<input type="checkbox"/> Enable
Authentication User Name	1234 (< 64 Digits)
Authentication Password	•••• (< 21 Digits)
E-mail From	abcd@planet.com.tw (< 128 Digits)
E-mail Subject	PLANET (< 64 Digits)
E-mail 1 To	abcd@planet.com.tw (< 128 Digits)
E-mail 2 To	abcd@planet.com.tw (< 128 Digits)

Figure 4-2-17: SMTP Configuration Page Screenshot

The page includes the following fields:

Object	Description
• SMTP Mode	Enabled It is for you to enable SMTP mode function. This mode offers you to configure SMTP server and SMTP account information, system will refer it to send an E-mail for alarm noticing
• SMTP Server	It is for you to set up a specified SMTP server DNS name or IP address. If a DNS name is inputted, please remember to input DNS server IP address on the IP configuration page.
• SMTP Port	It is for you to input the SMTP server port number. The default is "25".
• SMTP Authentication	Enabled As usual SMTP server is denied to relay a mail from a different domain, so you have to enable this option and input your mail account and password for SMTP sever authorizing to forward a mail from a different domain. For example, you want an SMTP server, which is located on mail.123.com, to send a mail to mail.456.net.com. If you want to send the mail to a SMTP server which is located on the same domain or the same SMTP server, you don't have to enable SMTP authentication.
• Authentic User Name	It is for you to input your mail account name.
• Authentication Password	It is for you to input your mail account password.
• E-mail From	It is for you to input who send this mail.
• E-mail Subject	It is for you to input mail subject.
• E-mail 1 To	It is for you to input recipient mail address.
• E-mail 2 To	It is for you to input secondary recipient mail address.

Buttons

: Click to test SMTP server address.

: Click to save changes.

: Click to undo any changes made locally and revert to previously saved values.

4.2.15 EEE Power Reduction

This page allows the user to configure the current EEE port settings.

EEE is a power saving option that reduces the power usage when there is low or no traffic utilization.

EEE works by powering down circuits when there is no traffic. When a port gets data to be transmitted, all circuits are powered up. The time it takes to power up the circuits is named wakeup time. The default wakeup time is 17 us for 1Gbit links and 30 us for other link speeds. EEE devices must agree upon the value of the wakeup time in order to make sure that both the receiving and transmitting device has all circuits powered up when traffic is transmitted. The devices can exchange wakeup time information using the LLDP protocol.

For maximizing power savings, the circuit isn't started at once transmit data is ready for a port, but is instead queued until 3000 bytes of data is ready to be transmitted. For not introducing a large delay in case that data less than 3000 bytes shall be transmitted, data are always transmitted after 48 us, giving a maximum latency of 48 us + the wakeup time.

If desired it is possible to minimize the latency for specific frames, by mapping the frames to a specific queue (done with QOS), and then mark the queue as an urgent queue. When an urgent queue gets data to be transmitted, the circuits will be powered up at once and the latency will be reduced to the wakeup time.

EEE works for ports in auto-negotiation mode, where the port is negotiated to either 1G or 100Mbps full duplex mode. The EEE Power Reduction screen in [Figure 4-2-18](#) appears.

EEE Configuration

		EEE Urgent Queues							
Port	Enabled	1	2	3	4	5	6	7	8
*	<input type="checkbox"/>	<input type="checkbox"/>	<input type="checkbox"/>	<input type="checkbox"/>	<input type="checkbox"/>	<input type="checkbox"/>	<input type="checkbox"/>	<input type="checkbox"/>	<input type="checkbox"/>
1	<input type="checkbox"/>	<input type="checkbox"/>	<input type="checkbox"/>	<input type="checkbox"/>	<input type="checkbox"/>	<input type="checkbox"/>	<input type="checkbox"/>	<input type="checkbox"/>	<input type="checkbox"/>
2	<input type="checkbox"/>	<input type="checkbox"/>	<input type="checkbox"/>	<input type="checkbox"/>	<input type="checkbox"/>	<input type="checkbox"/>	<input type="checkbox"/>	<input type="checkbox"/>	<input type="checkbox"/>
3	<input type="checkbox"/>	<input type="checkbox"/>	<input type="checkbox"/>	<input type="checkbox"/>	<input type="checkbox"/>	<input type="checkbox"/>	<input type="checkbox"/>	<input type="checkbox"/>	<input type="checkbox"/>
4	<input type="checkbox"/>	<input type="checkbox"/>	<input type="checkbox"/>	<input type="checkbox"/>	<input type="checkbox"/>	<input type="checkbox"/>	<input type="checkbox"/>	<input type="checkbox"/>	<input type="checkbox"/>
5	<input type="checkbox"/>	<input type="checkbox"/>	<input type="checkbox"/>	<input type="checkbox"/>	<input type="checkbox"/>	<input type="checkbox"/>	<input type="checkbox"/>	<input type="checkbox"/>	<input type="checkbox"/>
6	<input type="checkbox"/>	<input type="checkbox"/>	<input type="checkbox"/>	<input type="checkbox"/>	<input type="checkbox"/>	<input type="checkbox"/>	<input type="checkbox"/>	<input type="checkbox"/>	<input type="checkbox"/>
7	<input type="checkbox"/>	<input type="checkbox"/>	<input type="checkbox"/>	<input type="checkbox"/>	<input type="checkbox"/>	<input type="checkbox"/>	<input type="checkbox"/>	<input type="checkbox"/>	<input type="checkbox"/>
8	<input type="checkbox"/>	<input type="checkbox"/>	<input type="checkbox"/>	<input type="checkbox"/>	<input type="checkbox"/>	<input type="checkbox"/>	<input type="checkbox"/>	<input type="checkbox"/>	<input type="checkbox"/>
9	<input type="checkbox"/>	<input type="checkbox"/>	<input type="checkbox"/>	<input type="checkbox"/>	<input type="checkbox"/>	<input type="checkbox"/>	<input type="checkbox"/>	<input type="checkbox"/>	<input type="checkbox"/>
10	<input type="checkbox"/>	<input type="checkbox"/>	<input type="checkbox"/>	<input type="checkbox"/>	<input type="checkbox"/>	<input type="checkbox"/>	<input type="checkbox"/>	<input type="checkbox"/>	<input type="checkbox"/>

Figure 4-2-18: EEE Configuration Page Screenshot

The page includes the following fields:

Object	Description
<ul style="list-style-type: none"> • Port 	The switch port number of the logical EEE port, * means to select all ports of Industrial Managed Switch.
<ul style="list-style-type: none"> • EEE Enable 	Controls whether or not EEE is enabled for this switch port.
<ul style="list-style-type: none"> • EEE Urgent Queues 	Queues set will activate transmission of frames as soon as any data is available. Otherwise the queue will postpone the transmsion until 3000 bytes are ready to be transmitted.

Buttons



: Click to save changes.



: Click to undo any changes made locally and revert to previously saved values.

4.2.16 Web Firmware Upgrade

This page facilitates an update on the firmware controlling the **Industrial Managed Switch**. The Web Firmware Upgrade screen in [Figure 4-2-19](#) appears.



Figure 4-2-19: Web Firmware Upgrade Page Screenshot

To open **Firmware Upgrade** screen perform the following:

1. Click **System** -> **Web Firmware Upgrade**.
2. The Firmware Upgrade screen is displayed as in [Figure 4-2-19](#).
3. Click the **Browse** button of the main page, the system would pop up the file selection menu to choose firmware.
4. Select on the firmware and then click **Upload**, the **Software Upload Progress** would show the file upload status.
5. Once the software is loaded to the system successfully, the following screen appears. The system will load the new software after reboot.

Firmware update in progress

**The uploaded firmware image is being transferred to flash.
The system will restart after the update.
Until then, do not reset or power off the device!**



Completed!

Figure 4-2-20: Software successfully Loaded Notice Screen



DO NOT Power OFF the **Industrial Managed Switch** until the update progress is complete.



Do not quit the Firmware Upgrade page without pressing the **“OK”** button after the image is loaded. Or the system won't apply for the new firmware. User has to repeat the firmware upgrade processes again.

4.2.17 TFTP Firmware Upgrade

The **Firmware Upgrade** page provides the functions to allow a user to update the **Industrial Managed Switch** firmware from the TFTP server in the network. Before updating, make sure you have your TFTP server ready and the firmware image is on the TFTP server. The TFTP Firmware Upgrade screen in [Figure 4-2-21](#) appears.

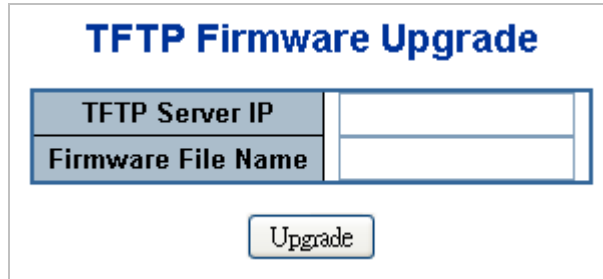



Figure 4-2-21: TFTP Firmware Update Page Screenshot

The page includes the following fields:

Object	Description
<ul style="list-style-type: none"> • TFTP Server IP 	Fill in your TFTP server IP address.
<ul style="list-style-type: none"> • Firmware File Name 	The name of firmware image. (Maximum length : 24 characters)

Buttons

 **Upgrade**: Click to upgrade firmware.



DO NOT Power OFF the **Industrial Managed Switch** until the update progress is complete.



Do not quit the Firmware Upgrade page without press the **“OK”** button after the image is loaded. Or the system won't apply for the new firmware. User has to repeat the firmware upgrade processes again.

4.2.18 Configuration Backup

This function allows backup and reload the current configuration of the **Industrial Managed Switch** to the local management station. The Configuration Backup screen in [Figure 4-2-22](#) appears.

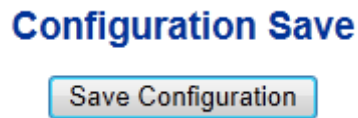

Figure 4-2-22: Configuration Save Page Screenshot

You can save/view or load the switch configuration. The configuration file is in XML format with a hierarchy of tags:

Header tags:	<?xml version="1.0"?> and <configuration>. These tags are mandatory and must be present at the beginning of the file.
Section tags:	<platform>, <global> and <switch>. The platform section must be the first section tag and this section must include the correct platform ID and version. The global section is optional and includes configuration which is not related to specific switch ports. The switch section is optional and includes configuration which is related to specific switch ports.
Module tags:	<ip>, <mac>, <port> etc. These tags identify a module controlling specific parts of the configuration.
Group tags:	<port_table>, <vlan_table> etc. These tags identify a group of parameters, typically a table.
Parameter tags:	<mode>, <entry> etc. These tags identify parameters for the specific section, module and group. The <entry> tag is used for table entries.

Configuration parameters are represented as attribute values. When saving the configuration from the switch, the entire configuration including syntax descriptions is included in the file. The file may then be modified using an editor and loaded to a **Industrial Managed Switch**.

The examples below show a small configuration file only including configuration of the MAC address age time and the learning mode per port. When loading this file, only the included parameters will be changed. This means that the age time will be set to 200 and the learn mode will be set to automatic.

■ Save Configuration

1. Press the **"Save Configuration"** button to save the current configuration in manager workstation. The following screens in [Figure 4-2-23](#) & [4-2-24](#) appear

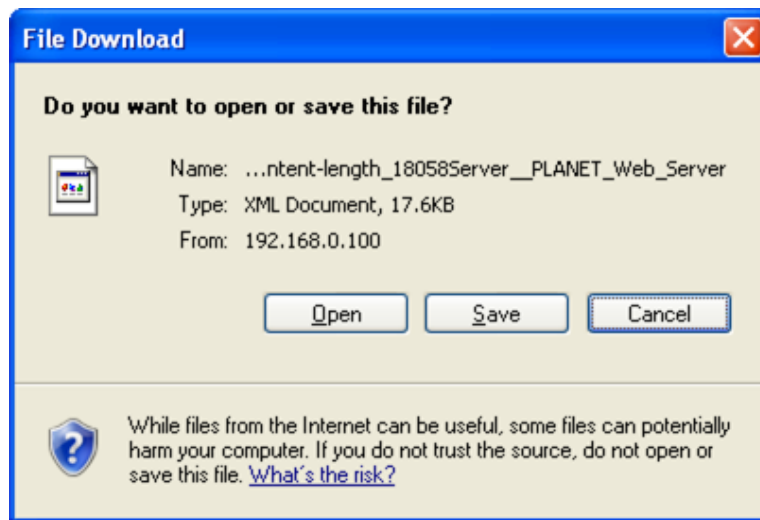

Figure 4-2-23: File Download Screen

2. Choose the file save path in management workstation.

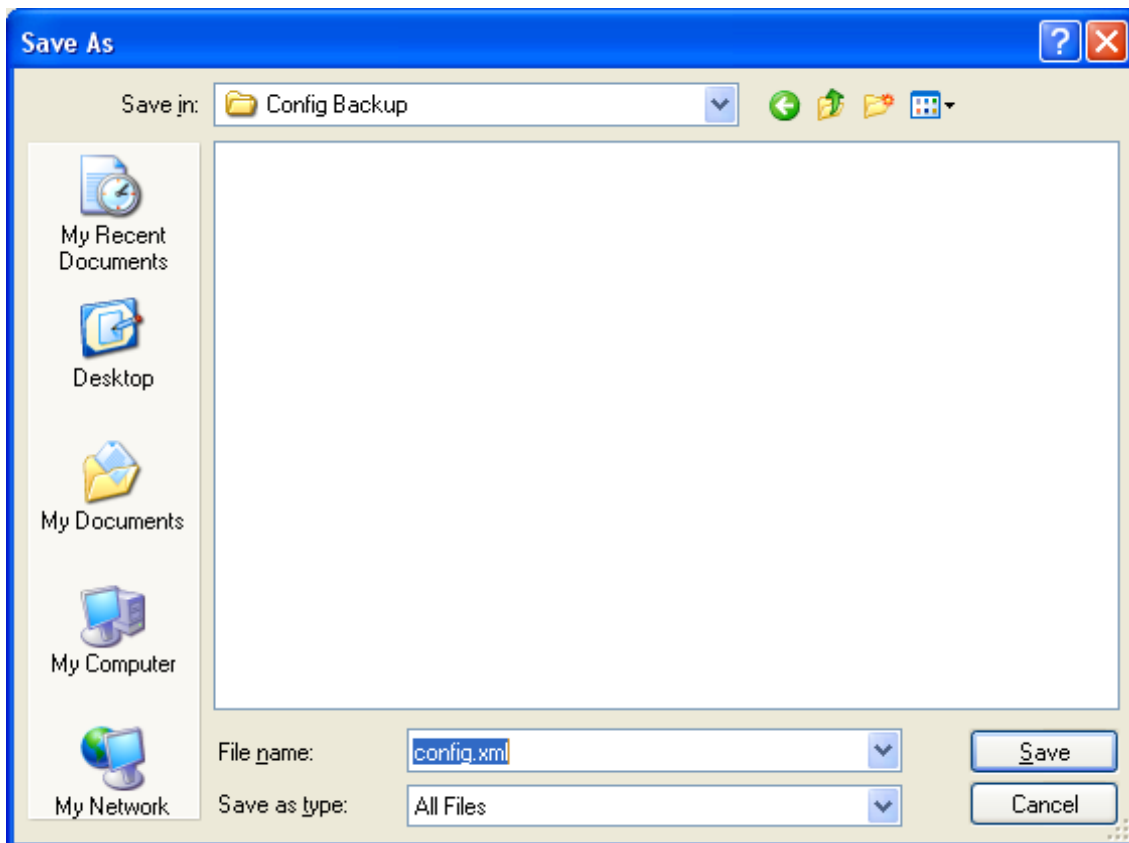

Figure 4-2-24: File Save Screen

4.2.19 Configuration Upload

This function allows backup and reload the current configuration of the **Industrial Managed Switch** to the local management station. The Configuration Upload screen in [Figure 4-2-25](#) appears.



Figure 4-2-25: Configuration Upload Page Screenshot

■ Configuration Upload

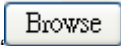
1. Click the  button of the main page, the system would pop up the file selection menu to choose saved configuration.

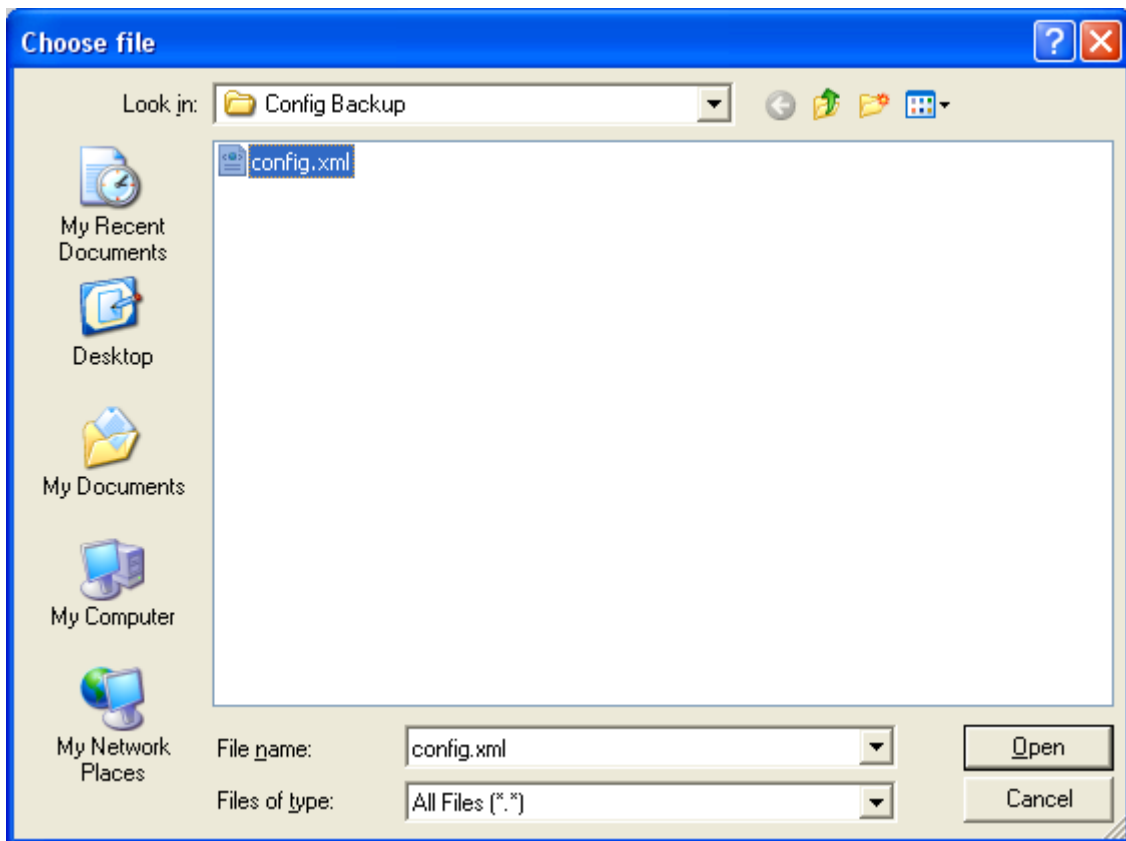

Figure 4-2-26: Windows File Selection Menu Popup

2. Select on the configuration file and then click , the bottom of the browser shows the upload status.
3. After down, the main screen appears **“Transfer Completed”**.

4.2.20 Image Select

This function provides dual image deposit in the **Industrial Managed Switch**, user can select any one of the image as Active image of **Industrial Managed Switch**. The Image Select screen in [Figure 4-2-27](#) appears.

Software Image Selection

Active Image	
Image	managed
Version	1.0b120618
Date	2012-06-18T10:43:11+0800

Alternate Image	
Image	managed.bk
Version	1.0b120611
Date	2012-06-11T17:27:45+0800

Figure 4-2-27: Image Select Page Screenshot

Button

: Click to choose Alternate Image as Activate Image.

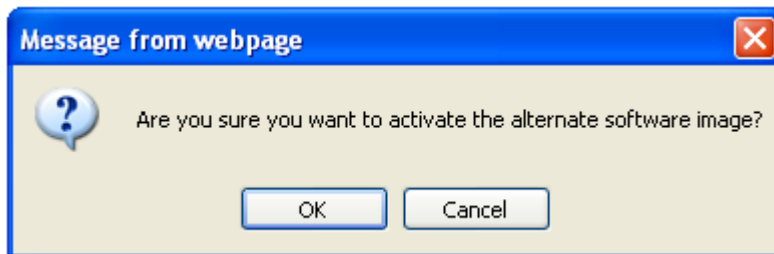

Figure 4-2-28: Image Select Page Screenshot

System restart in progress

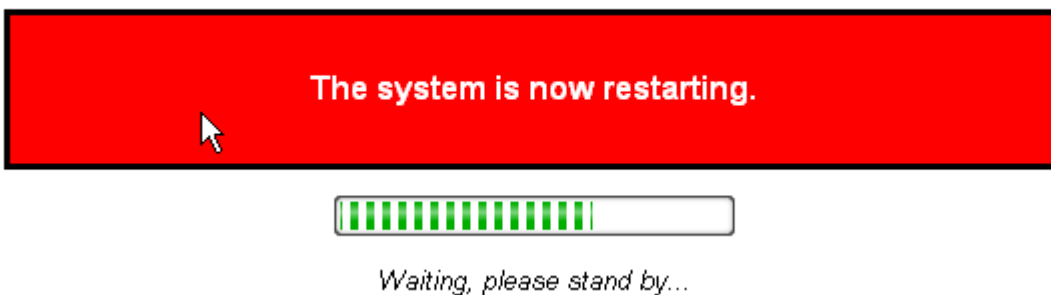

Figure 4-2-29: Image Select Page Screenshot

13

System restart in progress



Polling...

Figure 4-2-30: Image Select Page Screenshot

System restart in progress



Completed!

Figure 4-2-31: Image Select Page Screenshot

After the system reboot, you can use the Alternate Image of **Industrial Managed Switch**.

4.2.21 Factory Default

You can reset the configuration of the stack switch on this page. Only the IP configuration is retained. The new configuration is available immediately, which means that no restart is necessary. The Factory Default screen in [Figure 4-2-32](#) appears.



Figure 4-2-32: Factory Default Page Screenshot

Buttons

: Click to reset the configuration to Factory Defaults.



Figure 4-2-33: Factory Default Page Screenshot

: Click to return to the web main page without resetting the configuration.

After the “**Factory**” button is pressed and rebooted, the system will load the default IP settings as following:

- Default IP address: **192.168.0.100**
- Subnet mask: **255.255.255.0**
- Default Gateway: **192.168.0.254**
- The other setting value is back to disable or none.

To reset the **Industrial Managed Switch** to the Factory default setting, you can also press the hardware reset button at the front panel for about 5 seconds. After the device is rebooted, you can login the management WEB interface within the same subnet of 192.168.0.xx.



Note

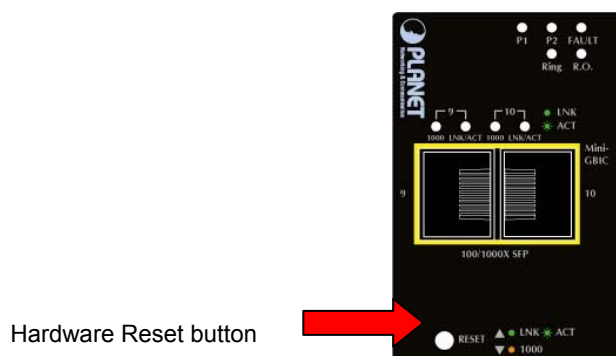

Hardware Reset button

4.2.22 System Reboot

The **Reboot** page enables the device to be rebooted from a remote location. Once the Reboot button is pressed, user will re-access the WEB interface about 60 seconds later. The System Reboot screen in [Figure 4-2-34](#) appears.



Figure 4-2-34: System Reboot Page Screenshot

Buttons

: Click to reboot the system.

: Click to return to the web main page without rebooting the system.

4.2.23 Daylight Saving

The **Reboot** page enables the device to be rebooted from a remote location. Once the Reboot button is pressed, user will re-access the WEB interface about 60 seconds later, the System Reboot screen in [Figure 4-2-35](#) appears.

The screenshot shows two configuration sections. The first section, titled "Time Zone Configuration", contains a dropdown menu for "Time Zone" set to "None" and a text input field for "Acronym" with a note "(0 - 16 characters)". The second section, titled "Daylight Saving Time Configuration", contains a dropdown menu for "Daylight Saving Time" set to "Disabled". Below this are two sub-sections: "Start Time settings" and "End Time settings". Each sub-section has five fields: "Month" (dropdown, "Jan"), "Date" (dropdown, "1"), "Year" (dropdown, "2000"), "Hours" (dropdown, "0"), and "Minutes" (dropdown, "0"). At the bottom of the second section is an "Offset settings" section with an "Offset" field set to "1" and a note "(1 - 1440) Minutes". At the very bottom are "Save" and "Reset" buttons.

Figure 4-2-35: System Reboot Page Screenshot

The page includes the following fields:

Object	Description
<ul style="list-style-type: none"> • Time Zone 	Allow select the time zone according to current location of switch.
<ul style="list-style-type: none"> • Acronm 	User can set the acronym of the time zone. This is a User configurable acronym to identify the time zone. (Range : Up to 16 alpha-numeric characters and can contain '-', '_' or '.')
<ul style="list-style-type: none"> • Daylight Saving Time 	is is used to set the clock forward or backward according to the configurations set below for a defined Daylight Saving Time duration. Select 'Disable' to disable the Daylight Saving Time configuration. Select 'Recurring' and configure the Daylight Saving Time duration to repeat the configuration every year. Select 'Non-Recurring' and configure the

	Daylight Saving Time duration for single time configuration. (Default : Disabled)
--	---

Daylight Saving Rime – **Recurring Mode**

Object	Description
• Week (Start Time Setting)	Select the starting week number.
• Day (Start Time Setting)	Select the starting day.
• Month (Start Time Setting)	Select the starting month.
• Hours (Start Time Setting)	Select the starting hour.
• Minutes (Start Time Setting)	Select the starting minute.
• Week (End Time Setting)	Select the ending week number.
• Day (End Time Setting)	Select the ending day.
• Month (End Time Setting)	Select the ending month.
• Hours (End Time Setting)	Select the ending hour.
• Month (End Time Setting)	Select the ending minute.
• Offest	Enter the number of minutes to add during Daylight Saving Time. (Range: 1 to 1440)

Daylight Saving Rime – **Non-Recurring Mode**

Object	Description
• Month (Start Time Setting)	Select the starting month.
• Date (Start Time Setting)	Select the starting date.
• Year (Start Time Setting)	Select the starting year.
• Hours (Start Time Setting)	Select the starting hour.
• Minutes (Start Time Setting)	Select the starting minute.
• Month (End Time Setting)	Select the ending month.
• Date (End Time Setting)	Select the ending date.
• Year (End Time Setting)	Select the ending year.
• Hours (End Time Setting)	Select the ending hour.
• Minutes (End Time Setting)	Select the ending minute.
• Offset	<ul style="list-style-type: none"> Enter the number of minutes to add during Daylight Saving Time. (Range: 1 to 1440)

Buttons

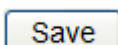
: Click to save changes.

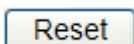
: Click to undo any changes made locally and revert to previously saved values.

4.3 Simple Network Management Protocol

4.3.1 SNMP Overview

The Simple Network Management Protocol (SNMP) is an application layer protocol that facilitates the exchange of management information between network devices. It is part of the Transmission Control Protocol/Internet Protocol (TCP/IP) protocol suite. SNMP enables network administrators to manage network performance, find and solve network problems, and plan for network growth.

An SNMP-managed network consists of three key components: Network management stations (NMSs), SNMP agents, Management information base (MIB) and network-management protocol :

- **Network management stations (NMSs)** : Sometimes called consoles, these devices execute management applications that monitor and control network elements. Physically, NMSs are usually engineering workstation-caliber computers with fast CPUs, megapixel color displays, substantial memory, and abundant disk space. At least one NMS must be present in each managed environment.
- **Agents** : Agents are software modules that reside in network elements. They collect and store management information such as the number of error packets received by a network element.
- **Management information base (MIB)** : A MIB is a collection of managed objects residing in a virtual information store. Collections of related managed objects are defined in specific MIB modules.
- **network-management protocol** : A management protocol is used to convey management information between agents and NMSs. SNMP is the Internet community's de facto standard management protocol.

SNMP Operations

SNMP itself is a simple request/response protocol. NMSs can send multiple requests without receiving a response.

- **Get** -- Allows the NMS to retrieve an object instance from the agent.
- **Set** -- Allows the NMS to set values for object instances within an agent.
- **Trap** -- Used by the agent to asynchronously inform the NMS of some event. The SNMPv2 trap message is designed to replace the SNMPv1 trap message.

SNMP community

An SNMP community is the group that devices and management stations running SNMP belong to. It helps define where information is sent. The community name is used to identify the group. A SNMP device or agent may belong to more than one SNMP community. It will not respond to requests from management stations that do not belong to one of its communities. SNMP default communities are:

- **Write** = private
- **Read** = public

Use the SNMP Menu to display or configure the Managed Switch's SNMP function. This section has the following items:

- | | |
|-------------------------------|--|
| ■ System Configuration | Configure SNMP on this page. |
| ■ System Information | The system information is provides here. |
| ■ SNMPv3 Communities | Configure SNMPv3 communities table on this page. |
| ■ SNMPv3 Users | Configure SNMPv3 users table on this page. |

- **SNMPv3 Groups** Configure SNMPv3 groups table on this page.
- **SNMPv3 Views** Configure SNMPv3 views table on this page.
- **SNMPv3 Accesses** Configure SNMPv3 accesses table on this page.

4.3.2 SNMP System Configuration

Configure SNMP on this page. The SNMP System Configuration screen in [Figure 4-3-1](#) appears.

SNMP System Configuration

Mode	Enabled ▼
Version	SNMP v2c ▼
Read Community	public
Write Community	private
Engine ID	800007e5017f000001

SNMP Trap Configuration

Trap Mode	Disabled ▼
Trap Version	SNMP v1 ▼
Trap Community	public
Trap Destination Address	
Trap Destination IPv6 Address	::
Trap Authentication Failure	Enabled ▼
Trap Link-up and Link-down	Enabled ▼
Trap Inform Mode	Enabled ▼
Trap Inform Timeout (seconds)	1
Trap Inform Retry Times	5

Figure 4-3-1: SNMP System Configuration Page Screenshot

The SNMP System Configuration page includes the following fields:

Object	Description
8. Mode	Indicates the SNMP mode operation. Possible modes are: <ul style="list-style-type: none"> ■ Enabled: Enable SNMP mode operation. ■ Disabled: Disable SNMP mode operation.
9. Version	Indicates the SNMP supported version. Possible versions are: <ul style="list-style-type: none"> ■ SNMP v1: Set SNMP supported version 1. ■ SNMP v2c: Set SNMP supported version 2c. ■ SNMP v3: Set SNMP supported version 3.
• Read Community	Indicates the community read access string to permit access to SNMP agent.

	<p>The allowed string length is 0 to 255, and the allowed content is the ASCII characters from 33 to 126.</p> <p>The field is applicable only when SNMP version is SNMPv1 or SNMPv2c. If SNMP version is SNMPv3, the community string will be associated with SNMPv3 communities table. It provides more flexibility to configure security name than a SNMPv1 or SNMPv2c community string. In addition to community string, a particular range of source addresses can be used to restrict source subnet.</p>
<ul style="list-style-type: none"> • Write Community 	<p>Indicates the community write access string to permit access to SNMP agent. The allowed string length is 0 to 255, and the allowed content is the ASCII characters from 33 to 126.</p> <p>The field is applicable only when SNMP version is SNMPv1 or SNMPv2c. If SNMP version is SNMPv3, the community string will be associated with SNMPv3 communities table. It provides more flexibility to configure security name than a SNMPv1 or SNMPv2c community string. In addition to community string, a particular range of source addresses can be used to restrict source subnet.</p>
<ul style="list-style-type: none"> • Engine ID 	<p>Indicates the SNMPv3 engine ID. The string must contain an even number(in hexadecimal format) with number of digits between 10 and 64, but all-zeros and all-'F's are not allowed. Change of the Engine ID will clear all original local users.</p>

The SNMP Trap Configuration page includes the following fields:

Object	Description
10. Trap Mode	<p>Indicates the SNMP trap mode operation. Possible modes are:</p> <ul style="list-style-type: none"> ■ Enabled: Enable SNMP trap mode operation. ■ Disabled: Disable SNMP trap mode operation.
11. Trap Version	<p>Indicates the SNMP trap supported version. Possible versions are:</p> <ul style="list-style-type: none"> ■ SNMP v1: Set SNMP trap supported version 1. ■ SNMP v2c: Set SNMP trap supported version 2c. ■ SNMP v3: Set SNMP trap supported version 3.
<ul style="list-style-type: none"> • Trap Community 	<p>Indicates the community access string when send SNMP trap packet. The allowed string length is 0 to 255, and the allowed content is the ASCII characters from 33 to 126.</p>
<ul style="list-style-type: none"> • Trap Destination Address 	<p>Indicates the SNMP trap destination address. It allow a valid IP address in dotted decimal notation ('x.y.z.w').</p> <p>And it also allow a valid hostname. A valid hostname is a string drawn from the alphabet (A-Za-z), digits (0-9), dot (.), dash (-). Spaces are not allowed, the first character must be an alpha character, and the first and last characters must not be a dot or a dash.</p>
<ul style="list-style-type: none"> • Trap Destination IPv6 Address 	<p>Indicates the SNMP trap destination IPv6 address. IPv6 address is in 128-bit records represented as eight fields of up to four hexadecimal digits with a colon</p>

	<p>separating each field (:). For example, 'fe80::215:c5ff:fe03:4dc7'. The symbol '::' is a special syntax that can be used as a shorthand way of representing multiple 16-bit groups of contiguous zeros; but it can appear only once. It can also represent a legally valid IPv4 address. For example, '::192.1.2.34'.</p>
<p>12. Trap Authentication Failure</p>	<p>Indicates the SNMP entity is permitted to generate authentication failure traps. Possible modes are:</p> <ul style="list-style-type: none"> ■ Enabled: Enable SNMP trap authentication failure. ■ Disabled: Disable SNMP trap authentication failure.
<p>13. Trap Link-up and Link-down</p>	<p>Indicates the SNMP trap link-up and link-down mode operation. Possible modes are:</p> <ul style="list-style-type: none"> ■ Enabled: Enable SNMP trap link-up and link-down mode operation. ■ Disabled: Disable SNMP trap link-up and link-down mode operation.
<p>14. Trap Inform Mode</p>	<p>Indicates the SNMP trap inform mode operation. Possible modes are:</p> <ul style="list-style-type: none"> ■ Enabled: Enable SNMP trap inform mode operation. ■ Disabled: Disable SNMP trap inform mode operation.
<ul style="list-style-type: none"> • Trap Inform Timeout (seconds) 	<p>Indicates the SNMP trap inform timeout. The allowed range is 0 to 2147.</p>
<ul style="list-style-type: none"> • Trap Inform Retry Times 	<p>Indicates the SNMP trap informs retry times. The allowed range is 0 to 255.</p>

Buttons



: Click to save changes.



: Click to undo any changes made locally and revert to previously saved values.

4.3.3 SNMP System Information

The switch system information is provided here. The SNMP System Information screen in [Figure 4-3-2](#) appears.

System Information Configuration

System Contact	
System Name	IGS-10020MT
System Location	

Figure 4-3-2: System Information Configuration Page Screenshot

The page includes the following fields:

Object	Description
<ul style="list-style-type: none"> System Contact 	The textual identification of the contact person for this managed node, together with information on how to contact this person. The allowed string length is 0 to 255, and the allowed content is the ASCII characters from 32 to 126.
<ul style="list-style-type: none"> System Name 	An administratively assigned name for this managed node. By convention, this is the node's fully-qualified domain name. A domain name is a text string drawn from the alphabet (A-Za-z), digits (0-9), minus sign (-). No space characters are permitted as part of a name. The first character must be an alpha character. And the first or last character must not be a minus sign. The allowed string length is 0 to 255.
<ul style="list-style-type: none"> System Location 	The physical location of this node(e.g., telephone closet, 3rd floor). The allowed string length is 0 to 255, and the allowed content is the ASCII characters from 32 to 126.

Buttons

: Click to save changes.

: Click to undo any changes made locally and revert to previously saved values.

4.3.4 SNMPv3 Configuration

4.3.4.1 SNMPv3 Communities

Configure SNMPv3 communities table on this page. The entry index key is Community. The SNMPv3 Communities screen in [Figure 4-3-3](#) appears.

SNMPv3 Community Configuration

Delete	Community	Source IP	Source Mask
<input type="checkbox"/>	public	0.0.0.0	0.0.0.0
<input type="checkbox"/>	private	0.0.0.0	0.0.0.0

Figure 4-3-3: SNMPv3 Communities Configuration Page Screenshot

The page includes the following fields:

Object	Description
<ul style="list-style-type: none"> • Delete 	Check to delete the entry. It will be deleted during the next save.
<ul style="list-style-type: none"> • Community 	Indicates the community access string to permit access to SNMPv3 agent. The allowed string length is 1 to 32, and the allowed content is ASCII characters from 33 to 126. The community string will be treated as security name and map a SNMPv1 or SNMPv2c community string.
<ul style="list-style-type: none"> • Source IP 	Indicates the SNMP access source address. A particular range of source addresses can be used to restrict source subnet when combined with source mask.
<ul style="list-style-type: none"> • Source Mask 	Indicates the SNMP access source address mask.

Buttons

: Click to add a new community entry.

: Click to save changes.

: Click to undo any changes made locally and revert to previously saved values.

4.3.4.2 SNMPv3 Users

Configure SNMPv3 users table on this page. The entry index keys are Engine ID and User Name. The SNMPv3 Users screen in Figure 4-3-4 appears.

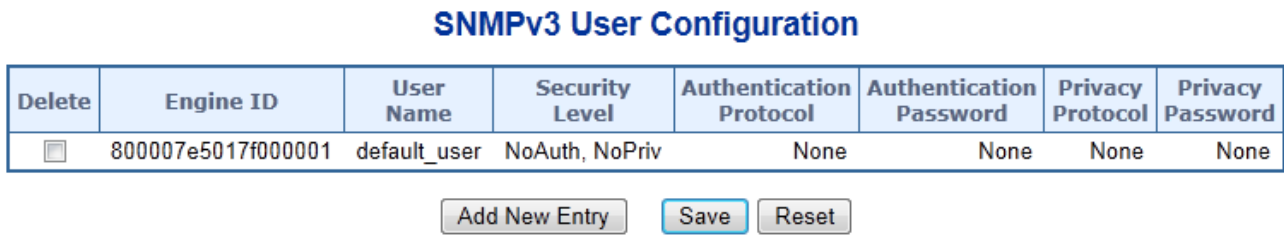

Figure 4-3-4: SNMPv3 Users Configuration Page Screenshot

The page includes the following fields:

Object	Description
<ul style="list-style-type: none"> • Delete 	Check to delete the entry. It will be deleted during the next save.
<ul style="list-style-type: none"> • Engine ID 	An octet string identifying the engine ID that this entry should belong to. The string must contain an even number (in hexadecimal format) with number of digits between 10 and 64, but all-zeros and all-F's are not allowed. The SNMPv3 architecture uses the User-based Security Model (USM) for message security and the View-based Access Control Model (VACM) for access control. For the USM entry, the usmUserEngineID and usmUserName are the entry's keys. In a simple agent, usmUserEngineID is always that agent's own snmpEngineID value. The value can also take the value of the snmpEngineID of a remote SNMP engine with which this user can communicate. In other words, if user engine ID equal system engine ID then it is local user; otherwise it's remote user.
<ul style="list-style-type: none"> • User Name 	A string identifying the user name that this entry should belong to. The allowed string length is 1 to 32, and the allowed content is the ASCII characters from 33 to 126.
15. Security Level	<p>Indicates the security model that this entry should belong to. Possible security models are:</p> <ul style="list-style-type: none"> ■ NoAuth, NoPriv: None authentication and none privacy. ■ Auth, NoPriv: Authentication and none privacy. ■ Auth, Priv: Authentication and privacy. <p>The value of security level cannot be modified if entry already exist. That means must first ensure that the value is set correctly.</p>
16. Authentication Protocol	<p>Indicates the authentication protocol that this entry should belong to. Possible authentication protocol are:</p> <ul style="list-style-type: none"> ■ None: None authentication protocol. ■ MD5: An optional flag to indicate that this user using MD5 authentication protocol.

	<ul style="list-style-type: none"> ■ SHA: An optional flag to indicate that this user using SHA authentication protocol. ■ The value of security level cannot be modified if entry already exists. That means must first ensure that the value is set correctly.
17. Authentication Password	A string identifying the authentication pass phrase. For MD5 authentication protocol, the allowed string length is 8 to 32. For SHA authentication protocol, the allowed string length is 8 to 40. The allowed content is the ASCII characters from 33 to 126.
18. Privacy Protocol	Indicates the privacy protocol that this entry should belong to. Possible privacy protocol are: <ul style="list-style-type: none"> ■ None: None privacy protocol. ■ DES: An optional flag to indicate that this user using DES authentication protocol.
• Privacy Password	A string identifying the privacy pass phrase. The allowed string length is 8 to 32, and the allowed content is the ASCII characters from 33 to 126.

Buttons

Add New Entry

: Click to add a new user entry.

Save

: Click to save changes.

Reset

: Click to undo any changes made locally and revert to previously saved values.

4.3.4.3 SNMPv3 Groups

Configure SNMPv3 groups table on this page. The entry index keys are Security Model and Security Name. The SNMPv3 Groups screen in [Figure 4-3-5](#) appears.

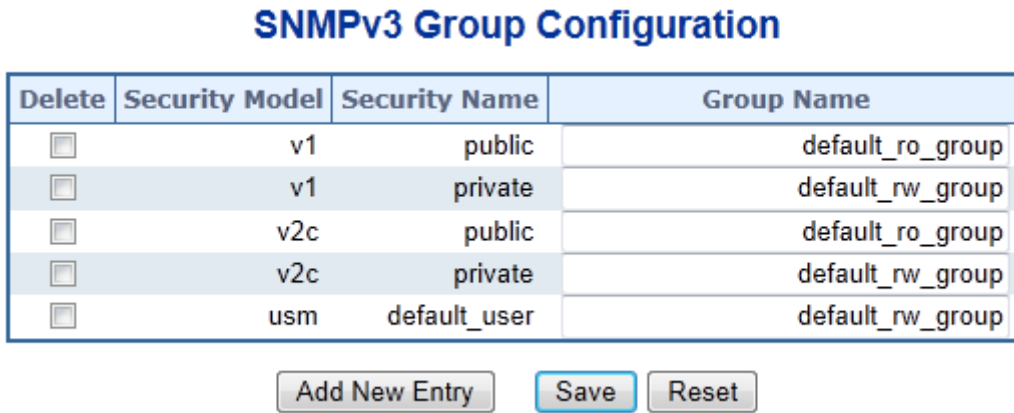

Figure 4-3-5: SNMPv3 Groups Configuration Page Screenshot

The page includes the following fields:

Object	Description
<ul style="list-style-type: none"> • Delete 	Check to delete the entry. It will be deleted during the next save.
<ul style="list-style-type: none"> • Security Model 	Indicates the security model that this entry should belong to. Possible security models are: <ul style="list-style-type: none"> ■ v1: Reserved for SNMPv1. ■ v2c: Reserved for SNMPv2c. ■ usm: User-based Security Model (USM).
<ul style="list-style-type: none"> • Security Name 	A string identifying the security name that this entry should belong to. The allowed string length is 1 to 32, and the allowed content is the ASCII characters from 33 to 126.
<ul style="list-style-type: none"> • Group Name 	A string identifying the group name that this entry should belong to. The allowed string length is 1 to 32, and the allowed content is the ASCII characters from 33 to 126.

Buttons

: Click to add a new group entry.

: Click to save changes.

: Click to undo any changes made locally and revert to previously saved values.

4.3.4.4 SNMPv3 Views

Configure SNMPv3 views table on this page. The entry index keys are View Name and OID Subtree. The SNMPv3 Views screen in [Figure 4-3-6](#) appears.

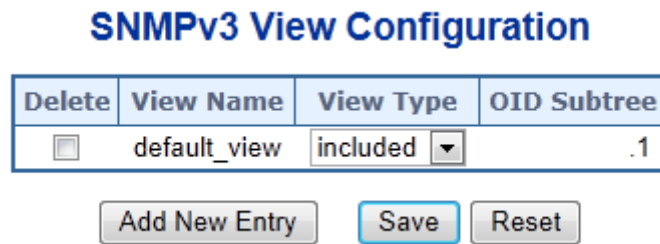

Figure 4-3-6: SNMPv3 Views Configuration Page Screenshot

The page includes the following fields:

Object	Description
<ul style="list-style-type: none"> • Delete 	Check to delete the entry. It will be deleted during the next save.
<ul style="list-style-type: none"> • View Name 	A string identifying the view name that this entry should belong to. The allowed string length is 1 to 32, and the allowed content is the ASCII characters from 33 to 126.
<ul style="list-style-type: none"> • View Type 	<p>Indicates the view type that this entry should belong to. Possible view type are:</p> <ul style="list-style-type: none"> ■ included: An optional flag to indicate that this view subtree should be included. ■ excluded: An optional flag to indicate that this view subtree should be excluded. <p>General, if a view entry's view type is 'excluded', it should be exist another view entry which view type is 'included' and it's OID subtree overstep the 'excluded' view entry.</p>
<ul style="list-style-type: none"> • OID Subtree 	The OID defining the root of the subtree to add to the named view. The allowed OID length is 1 to 128. The allowed string content is digital number or asterisk(*)

Buttons

Add New Entry : Click to add a new view entry.

Save : Click to save changes.

Reset : Click to undo any changes made locally and revert to previously saved values.

4.3.4.5 SNMPv3 Access

Configure SNMPv3 accesses table on this page. The entry index keys are Group Name, Security Model and Security Level. The SNMPv3 Access screen in [Figure 4-3-7](#) appears.

SNMPv3 Access Configuration

Delete	Group Name	Security Model	Security Level	Read View Name	Write View Name
<input type="checkbox"/>	default_ro_group	any	NoAuth, NoPriv	default_view ▼	None ▼
<input type="checkbox"/>	default_rw_group	any	NoAuth, NoPriv	default_view ▼	default_view ▼

Figure 4-3-7: SNMPv3 Accesses Configuration Page Screenshot

The page includes the following fields:

Object	Description
<ul style="list-style-type: none"> Delete 	Check to delete the entry. It will be deleted during the next save.
<ul style="list-style-type: none"> Group Name 	A string identifying the group name that this entry should belong to. The allowed string length is 1 to 32, and the allowed content is the ASCII characters from 33 to 126.
<p>19. Security Model</p>	Indicates the security model that this entry should belong to. Possible security models are: <ul style="list-style-type: none"> ■ any: Accepted any security model (v1 v2c usm). ■ v1: Reserved for SNMPv1. ■ v2c: Reserved for SNMPv2c. ■ usm: User-based Security Model (USM)
<p>20. Security Level</p>	Indicates the security model that this entry should belong to. Possible security models are: <ul style="list-style-type: none"> ■ NoAuth, NoPriv: None authentication and none privacy. ■ Auth, NoPriv: Authentication and none privacy. ■ Auth, Priv: Authentication and privacy.
<ul style="list-style-type: none"> Read View Name 	The name of the MIB view defining the MIB objects for which this request may request the current values. The allowed string length is 1 to 32, and the allowed content is the ASCII characters from 33 to 126.
<ul style="list-style-type: none"> Write View Name 	The name of the MIB view defining the MIB objects for which this request may potentially SET new values. The allowed string length is 1 to 32, and the allowed content is the ASCII characters from 33 to 126.

Buttons

 : Click to add a new access entry.

 : Click to save changes.

 : Click to undo any changes made locally and revert to previously saved values.

4.4 Port Management

Use the Port Menu to display or configure the Managed Switch's ports. This section has the following items:

- **Port Configuration** Configures port connection settings
- **Port Statistics Overview** Lists Ethernet and RMON port statistics
- **Port Thermal Protection** Configures thermal protection settings
- **Port Thermal Protection Status** Display thermal protection status
- **Port Statistics Detail** Lists Ethernet and RMON port statistics
- **SFP Information** Display SFP information
- **Port Mirror** Sets the source and target ports for mirroring

4.4.1 Port Configuration

This page displays current port configurations. Ports can also be configured here. The Port Configuration screen in [Figure 4-4-1](#) appears.

Port Configuration

Port	Port Description	Link	Speed		Flow Control			Maximum Frame Size	Excessive Collision Mode	Power Control
			Current	Configured	Current Rx	Current Tx	Configured			
*				<All>				9600	<All>	<All>
1		●	1Gfdx	Auto Copper	×	×		9600	Discard	Disabled
2		●	Down	Auto Copper	×	×		9600	Discard	Disabled
3		●	Down	Auto Copper	×	×		9600	Discard	Disabled
4		●	Down	Auto Copper	×	×		9600	Discard	Disabled
5		●	Down	Auto Copper	×	×		9600	Discard	Disabled
6		●	Down	Auto Copper	×	×		9600	Discard	Disabled
7		●	Down	Auto Copper	×	×		9600	Discard	Disabled
8		●	Down	Auto Copper	×	×		9600	Discard	Disabled
9		●	Down	Auto Fiber	×	×		9600		
10		●	Down	Auto Fiber	×	×		9600		

Figure 4-4-1: Port Configuration Page Screenshot

The page includes the following fields:

Object	Description
• Port	This is the logical port number for this row.
• Port Description	This function provides input per port description and the available letters is 12.
• Link	The current link state is displayed graphically. Green indicates the link is up and red that it is down.
• Current Link Speed	Provides the current link speed of the port.

<ul style="list-style-type: none"> • Configured Link Speed 	<p>Select any available link speed for the given switch port. Draw the menu bar to select the mode.</p> <ul style="list-style-type: none"> ■ All- Setup whole ports with the same setting. ■ Auto Copper - Setup Auto negotiation. ■ Auto Fiber - Setup Auto negotiation. ■ 10 Half - Force sets 10Mbps/Half-Duplex mode. ■ 10 Full - Force sets 10Mbps/Full-Duplex mode. ■ 100 Half - Force sets 100Mbps/Half-Duplex mode. ■ 100 Full - Force sets 100Mbps/Full-Duplex mode. ■ 1000 Full - Force sets 1000Mbps/Full-Duplex mode. ■ Disable - Shutdown the port manually.
<ul style="list-style-type: none"> • Flow Control 	<p>When Auto Speed is selected on a port, this section indicates the flow control capability that is advertised to the link partner.</p> <p>When a fixed-speed setting is selected, that is what is used. The Current Rx column indicates whether pause frames on the port are obeyed, and the Current Tx column indicates whether pause frames on the port are transmitted. The Rx and Tx settings are determined by the result of the last Auto-Negotiation.</p> <p>Check the configured column to use flow control. This setting is related to the setting for Configured Link Speed.</p>
<ul style="list-style-type: none"> • Maximum Frame Size 	<p>Enter the maximum frame size allowed for the switch port, including FCS. The allowed range is 1518 bytes to 9600 bytes.</p>
<ul style="list-style-type: none"> • Excessive Collision Mode 	<p>Configure port transmit collision behavior.</p> <ul style="list-style-type: none"> ■ Discard: Discard frame after 16 collisions (default). ■ Restart: Restart back off algorithm after 16 collisions.
<ul style="list-style-type: none"> • Power Control 	<p>The Usage column shows the current percentage of the power consumption per port. The Configured column allows for changing the power savings mode parameters per port.</p> <ul style="list-style-type: none"> ■ Disabled: All power savings mechanisms disabled. ■ ActiPHY: Link down power savings enabled. ■ PerfectReach: Link up power savings enabled. ■ Enabled: Both link up and link down power savings enabled.



When set each port to run at 100M Full, 100M Half, 10M Full, and 10M Half-speed modes. The Auto-MDIX function will disable.

Buttons



: Click to save changes.



: Click to undo any changes made locally and revert to previously saved values.

Refresh: Click to refresh the page. Any changes made locally will be undone.

4.4.2 Port Statistics Overview

This page provides an overview of general traffic statistics for all switch ports. The Port Statistics Overview screen in [Figure 4-4-2](#) appears.

Port	Packets		Bytes		Errors		Drops		Filtered
	Received	Transmitted	Received	Transmitted	Received	Transmitted	Received	Transmitted	Received
1	286	358	44587	380528	0	0	0	0	0
2	0	0	0	0	0	0	0	0	0
3	0	0	0	0	0	0	0	0	0
4	0	0	0	0	0	0	0	0	0
5	0	0	0	0	0	0	0	0	0
6	0	0	0	0	0	0	0	0	0
7	0	0	0	0	0	0	0	0	0
8	0	0	0	0	0	0	0	0	0
9	0	0	0	0	0	0	0	0	0
10	0	0	0	0	0	0	0	0	0

Auto-refresh **Refresh** **Clear**

Figure 4-4-2: Port Statistics Overview Page Screenshot

The displayed counters are:

Object	Description
• Port	The logical port for the settings contained in the same row.
• Packets	The number of received and transmitted packets per port.
• Bytes	The number of received and transmitted bytes per port.
• Errors	The number of frames received in error and the number of incomplete transmissions per port.
• Drops	The number of frames discarded due to ingress or egress congestion.
• Filtered	The number of received frames filtered by the forwarding process.

Buttons

Refresh: Click to refresh the page immediately.

Clear: Clears the counters for all ports.

Auto-refresh : Check this box to enable an automatic refresh of the page at regular intervals.

4.4.3 Port Statistics Detail

This page provides detailed traffic statistics for a specific switch port. Use the port select box to select which switch port details to display. The selected port belong to the currently selected stack unit, as reflected by the page header. The displayed counters are the totals for receive and transmit, the size counters for receive and transmit, and the error counters for receive and transmit. The Port Statistics Detail screen in [Figure 4-4-3](#) appears.

Detailed Port Statistics Port 1			
Port 1		Auto-refresh <input type="checkbox"/>	Refresh Clear
Receive Total		Transmit Total	
Rx Packets	353	Tx Packets	408
Rx Octets	58126	Tx Octets	401574
Rx Unicast	352	Tx Unicast	408
Rx Multicast	0	Tx Multicast	0
Rx Broadcast	1	Tx Broadcast	0
Rx Pause	0	Tx Pause	0
Receive Size Counters		Transmit Size Counters	
Rx 64 Bytes	258	Tx 64 Bytes	28
Rx 65-127 Bytes	12	Tx 65-127 Bytes	8
Rx 128-255 Bytes	0	Tx 128-255 Bytes	48
Rx 256-511 Bytes	68	Tx 256-511 Bytes	66
Rx 512-1023 Bytes	15	Tx 512-1023 Bytes	26
Rx 1024-1526 Bytes	0	Tx 1024-1526 Bytes	232
Rx 1527- Bytes	0	Tx 1527- Bytes	0
Receive Queue Counters		Transmit Queue Counters	
Rx Q0	353	Tx Q0	0
Rx Q1	0	Tx Q1	0
Rx Q2	0	Tx Q2	0
Rx Q3	0	Tx Q3	0
Rx Q4	0	Tx Q4	0
Rx Q5	0	Tx Q5	0
Rx Q6	0	Tx Q6	0
Rx Q7	0	Tx Q7	408
Receive Error Counters		Transmit Error Counters	
Rx Drops	0	Tx Drops	0
Rx CRC/Alignment	0	Tx Late/Exc. Coll.	0
Rx Undersize	0		
Rx Oversize	0		
Rx Fragments	0		
Rx Jabber	0		
Rx Filtered	0		

Figure 4-4-5: Detailed Port Statistics Port 1 Page Screenshot

The page includes the following fields:

Receive Total and Transmit Total

Object	Description
• Rx and Tx Packets	The number of received and transmitted (good and bad) packets
• Rx and Tx Octets	The number of received and transmitted (good and bad) bytes. Includes FCS, but excludes framing bits.
• Rx and Tx Unicast	The number of received and transmitted (good and bad) unicast packets.
• Rx and Tx Multicast	The number of received and transmitted (good and bad) multicast packets.
• Rx and Tx Broadcast	The number of received and transmitted (good and bad) broadcast packets.
• Rx and Tx Pause	A count of the MAC Control frames received or transmitted on this port that have an opcode indicating a PAUSE operation.

Receive and Transmit Size Counters

The number of received and transmitted (good and bad) packets split into categories based on their respective frame sizes.

Receive and Transmit Queue Counters

The number of received and transmitted packets per input and output queue.

Receive Error Counters

Object	Description
• Rx Drops	The number of frames dropped due to lack of receive buffers or egress congestion.
• Rx CRC/Alignment	The number of frames received with CRC or alignment errors.
• Rx Undersize	The number of short ¹ frames received with valid CRC.
• Rx Oversize	The number of long ² frames received with valid CRC.
• Rx Fragments	The number of short ¹ frames received with invalid CRC.
• Rx Jabber	The number of long ² frames received with invalid CRC.
• Rx Filtered	The number of received frames filtered by the forwarding process. Short frames are frames that are smaller than 64 bytes. Long frames are frames that are longer than the configured maximum frame length for this port.



1 Short frames are frames that are smaller than 64 bytes.

2 Long frames are frames that are longer than the configured maximum frame length for this port.

Transmit Error Counters

Object	Description
• Tx Drops	The number of frames dropped due to output buffer congestion.
• Tx Late/Exc. Coll.	The number of frames dropped due to excessive or late collisions.

Buttons

: Click to refresh the page immediately.

: Clears the counters for all ports.

Auto-refresh : Check this box to enable an automatic refresh of the page at regular intervals.

4.4.4 SFP Information

You can check the physical or operational status of an SFP module via the SFP Module Information page. This page shows the operational status, such as the transceiver type, speed, and wavelength and supports distance of SFP module on a specific interface. You can also use the hyperlink of port no. to check the statistics on a specific interface. The SFP Module Information screen in [Figure 4-4-4](#) appears.

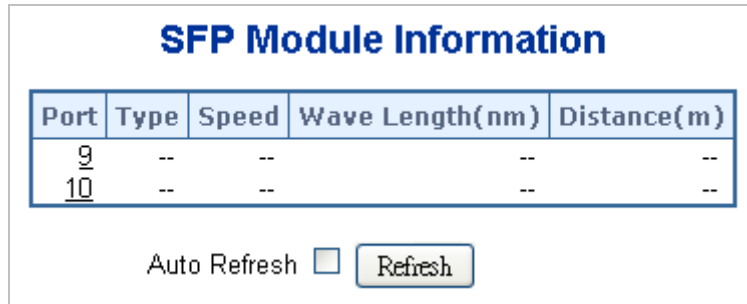

Figure 4-4-4: SFP Module Information for Switch Page Screenshot

The page includes the following fields:

Object	Description
<ul style="list-style-type: none"> Type 	Display the type of current SFP module, the possible types are: <ul style="list-style-type: none"> ■ 1000Base-SX ■ 1000Base-LX ■ 100Base-FX
<ul style="list-style-type: none"> Speed 	Display the speed of current SFP module, the speed value or description is get from the SFP module. Different vendors SFP modules might shows different speed information.
<ul style="list-style-type: none"> Wave Length(nm) 	Display the wavelength of current SFP module, the wavelength value is get from the SFP module. Use this column to check if the wavelength values of two nodes are the matched while the fiber connection is failed.
<ul style="list-style-type: none"> Distance(m) 	Display the supports distance of current SFP module, the distance value is get from the SFP module.

Buttons

Auto-refresh : Check this box to enable an automatic refresh of the page at regular intervals.

: Click to refresh the page immediately.

4.4.5 Port Mirror

Configure port Mirroring on this page. This function provide to monitoring network traffic that forwards a copy of each incoming or outgoing packet from one port of a network Switch to another port where the packet can be studied. It enables the manager to keep close track of switch performance and alter it if necessary.

- To debug network problems, selected traffic can be copied, or mirrored, to a mirror port where a frame analyzer can be attached to analyze the frame flow.
- The Managed Switch can unobtrusively mirror traffic from any port to a monitor port. You can then attach a protocol analyzer or RMON probe to this port to perform traffic analysis and verify connection integrity.



Figure 4-4-5: Port Mirror Application

The traffic to be copied to the mirror port is selected as follows:

- All frames received on a given port (also known as ingress or source mirroring).
- All frames transmitted on a given port (also known as egress or destination mirroring).

- **Mirror Port Configuration**

The Port Mirror screen in [Figure 4-4-6](#) appears.

Mirror Configuration

Port to mirror to Disabled ▾

Mirror Port Configuration

Port	Mode
*	<All> ▾
1	Disabled ▾
2	Disabled ▾
3	Disabled ▾
4	Disabled ▾
5	Disabled ▾
6	Disabled ▾
7	Disabled ▾
8	Disabled ▾
9	Disabled ▾
10	Disabled ▾
CPU	Disabled ▾

Save
Reset

Figure 4-4-6: Mirror Configuration Page Screenshot

The page includes the following fields:

Object	Description
• Port to mirror on	Port to mirror also known as the mirror port . Frames from ports that have either source (rx) or destination (tx) mirroring enabled are mirrored on this port. Disabled disables mirroring.
• Port	The logical port for the settings contained in the same row.
• Mode	Select mirror mode. Rx only : Frames received at this port are mirrored to the mirroring port. Frames transmitted are not mirrored. Tx only : Frames transmitted from this port are mirrored to the mirroring port. Frames received are not mirrored. Disabled : Neither frames transmitted or frames received are mirrored. Both : Frames received and frames transmitted are mirrored to the mirror port.



Note

For a given port, a frame is only transmitted once. It is therefore not possible to mirror Tx frames on the **mirror port**. Because of this, **mode** for the selected mirror port is limited to **Disabled** or **Rx only**.

4.5 Link Aggregation

Port Aggregation optimizes port usage by linking a group of ports together to form a single Link Aggregated Groups (LAGs). Port Aggregation multiplies the bandwidth between the devices, increases port flexibility, and provides link redundancy.

Each LAG is composed of ports of the same speed, set to full-duplex operations. Ports in a LAG, can be of different media types (UTP/Fiber, or different fiber types), provided they operate at the same speed.

Aggregated Links can be assigned manually (**Port Trunk**) or automatically by enabling Link Aggregation Control Protocol (**LACP**) on the relevant links.

Aggregated Links are treated by the system as a single logical port. Specifically, the Aggregated Link has similar port attributes to a non-aggregated port, including auto-negotiation, speed, Duplex setting, etc.

The device supports the following Aggregation links :

- **Static LAGs (Port Trunk)** – Force aggregated selected ports to be a trunk group.
- **Link Aggregation Control Protocol (LACP)** LAGs - LACP LAG negotiate Aggregated Port links with other LACP ports located on a different device. If the other device ports are also LACP ports, the devices establish a LAG between them.

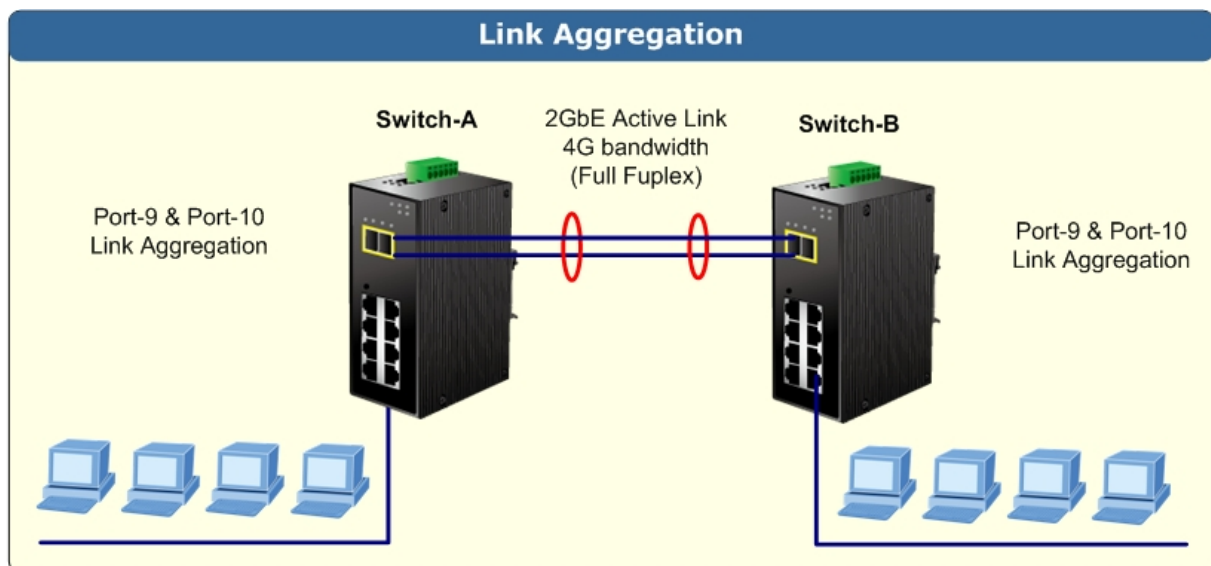

Figure 4-5-1: Link Aggregation Topology

The **Link Aggregation Control Protocol (LACP)** provides a standardized means for exchanging information between Partner Systems that require high speed redundant links. Link aggregation lets you group up to eight consecutive ports into a single dedicated connection. This feature can expand bandwidth to a device on the network. LACP operation requires full-duplex mode, more detail information refer to the IEEE 802.3ad standard.

Port link aggregations can be used to increase the bandwidth of a network connection or to ensure fault recovery. Link aggregation lets you group up to 4 consecutive ports into a single dedicated connection between any two the Switch or other Layer 2 switches. However, before making any physical connections between devices, use the Link aggregation Configuration menu to specify the link aggregation on the devices at both ends. When using a port link aggregation, note that:

- The ports used in a link aggregation must all be of the same media type (RJ-45, 100 Mbps fiber).
- The ports that can be assigned to the same link aggregation have certain other restrictions (see below).
- Ports can only be assigned to one link aggregation.
- The ports at both ends of a connection must be configured as link aggregation ports.
- None of the ports in a link aggregation can be configured as a mirror source port or a mirror target port.
- All of the ports in a link aggregation have to be treated as a whole when moved from/to, added or deleted from a VLAN.
- The Spanning Tree Protocol will treat all the ports in a link aggregation as a whole.
- Enable the link aggregation prior to connecting any cable between the switches to avoid creating a data loop.
- Disconnect all link aggregation port cables or disable the link aggregation ports before removing a port link aggregation to avoid creating a data loop.

It allows a maximum of 10 ports to be aggregated at the same time. The Managed Switch support Gigabit Ethernet ports (up to 5 groups). If the group is defined as a LACP static link aggregation group, then any extra ports selected are placed in a standby mode for redundancy if one of the other ports fails. If the group is defined as a local static link aggregation group, then the number of ports must be the same as the group member ports.

The aggregation code ensures that frames belonging to the same frame flow (for example, a TCP connection) are always forwarded on the same link aggregation member port. Reordering of frames within a flow is therefore not possible. The aggregation code is based on the following information:

- **Source MAC**
- **Destination MAC**
- **Source and destination IPv4 address.**
- **Source and destination TCP/UDP ports for IPv4 packets**

Normally, all 5 contributions to the aggregation code should be enabled to obtain the best traffic distribution among the link aggregation member ports. Each link aggregation may consist of up to 10 member ports. Any quantity of link aggregation s may be configured for the device (only limited by the quantity of ports on the device.) To configure a proper traffic distribution, the ports within a link aggregation must use the same link speed.

4.5.1 Static Aggregation

This page is used to configure the Aggregation hash mode and the aggregation group. The aggregation hash mode settings are global, whereas the aggregation group relate to the currently selected stack unit, as reflected by the page header.

Hash Code Contributors

The Static Aggregation screen in [Figure 4-5-2](#) appears.

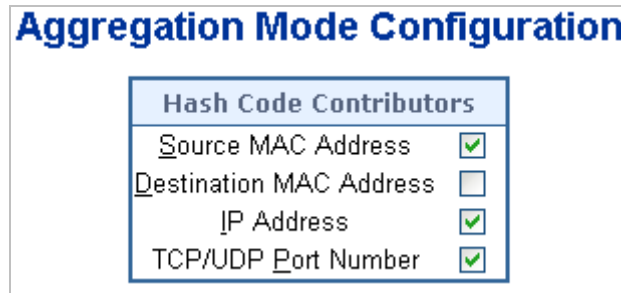

Figure 4-5-2 : Aggregation Mode Configuration Page Screenshot

The page includes the following fields:

Object	Description
<ul style="list-style-type: none"> • Source MAC Address 	The Source MAC address can be used to calculate the destination port for the frame. Check to enable the use of the Source MAC address, or uncheck to disable. By default, Source MAC Address is enabled.
<ul style="list-style-type: none"> • Destination MAC Address 	The Destination MAC Address can be used to calculate the destination port for the frame. Check to enable the use of the Destination MAC Address, or uncheck to disable. By default, Destination MAC Address is disabled.
<ul style="list-style-type: none"> • IP Address 	The IP address can be used to calculate the destination port for the frame. Check to enable the use of the IP Address, or uncheck to disable. By default, IP Address is enabled.
<ul style="list-style-type: none"> • TCP/UDP Port Number 	The TCP/UDP port number can be used to calculate the destination port for the frame. Check to enable the use of the TCP/UDP Port Number, or uncheck to disable. By default, TCP/UDP Port Number is enabled.

Static Aggregation Group Configuration

The Aggregation Group Configuration screen in [Figure 4-5-3](#) appears.

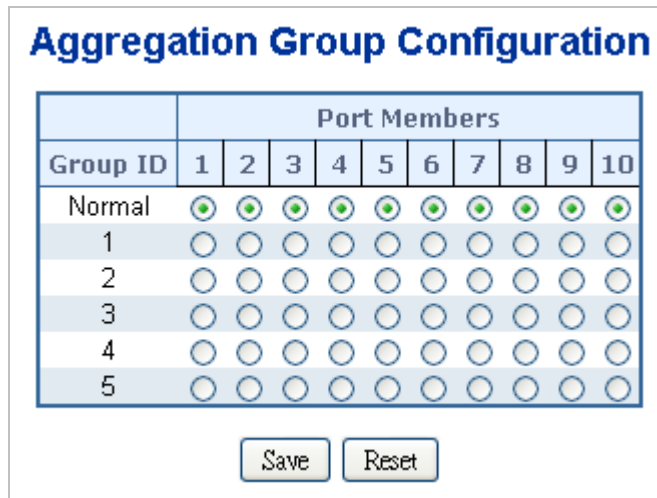

Figure 4-5-3: Aggregation Group Configuration Page Screenshot

The page includes the following fields:

Object	Description
<ul style="list-style-type: none"> Group ID 	Indicates the group ID for the settings contained in the same row. Group ID "Normal" indicates there is no aggregation. Only one group ID is valid per port.
<ul style="list-style-type: none"> Port Members 	Each switch port is listed for each group ID. Select a radio button to include a port in an aggregation, or clear the radio button to remove the port from the aggregation. By default, no ports belong to any aggregation group. Only full duplex ports can join an aggregation and ports must be in the same speed in each group.

Buttons

: Click to save changes.

: Click to undo any changes made locally and revert to previously saved values.

4.5.2 LACP Configuration

Link Aggregation Control Protocol (LACP) - LACP LAG negotiate Aggregated Port links with other LACP ports located on a different device. LACP allows switches connected to each other to discover automatically whether any ports are member of the same LAG.

This page allows the user to inspect the current LACP port configurations, and possibly change them as well. The LACP port settings relate to the currently selected stack unit, as reflected by the page header. The LACP Configuration screen in [Figure 4-5-4](#) appears.

LACP Port Configuration

Port	LACP Enabled	Key	Role	Timeout	Prio
*	<input type="checkbox"/>	<All> <input type="button" value="v"/>	<All> <input type="button" value="v"/>	<All> <input type="button" value="v"/>	32768
1	<input type="checkbox"/>	Auto <input type="button" value="v"/>	Active <input type="button" value="v"/>	Fast <input type="button" value="v"/>	32768
2	<input type="checkbox"/>	Auto <input type="button" value="v"/>	Active <input type="button" value="v"/>	Fast <input type="button" value="v"/>	32768
3	<input type="checkbox"/>	Auto <input type="button" value="v"/>	Active <input type="button" value="v"/>	Fast <input type="button" value="v"/>	32768
4	<input type="checkbox"/>	Auto <input type="button" value="v"/>	Active <input type="button" value="v"/>	Fast <input type="button" value="v"/>	32768
5	<input type="checkbox"/>	Auto <input type="button" value="v"/>	Active <input type="button" value="v"/>	Fast <input type="button" value="v"/>	32768
6	<input type="checkbox"/>	Auto <input type="button" value="v"/>	Active <input type="button" value="v"/>	Fast <input type="button" value="v"/>	32768
7	<input type="checkbox"/>	Auto <input type="button" value="v"/>	Active <input type="button" value="v"/>	Fast <input type="button" value="v"/>	32768
8	<input type="checkbox"/>	Auto <input type="button" value="v"/>	Active <input type="button" value="v"/>	Fast <input type="button" value="v"/>	32768
9	<input type="checkbox"/>	Auto <input type="button" value="v"/>	Active <input type="button" value="v"/>	Fast <input type="button" value="v"/>	32768
10	<input type="checkbox"/>	Auto <input type="button" value="v"/>	Active <input type="button" value="v"/>	Fast <input type="button" value="v"/>	32768

Figure 4-5-4 : LACP Port Configuration Page Screenshot

The page includes the following fields:

Object	Description
<ul style="list-style-type: none"> • Port 	The switch port number, * means selection of all ports of Industrial Managed Switch.
<ul style="list-style-type: none"> • LACP Enabled 	Controls whether LACP is enabled on this switch port. LACP will form an aggregation when 2 or more ports are connected to the same partner. LACP can form max 12 LLAGs per switch and 2 GLAGs per stack.
<ul style="list-style-type: none"> • Key 	The Key value incurred by the port, range 1-65535 . The Auto setting will set the key as appropriate by the physical link speed, 10Mb = 1, 100Mb = 2, 1Gb = 3. Using the Specific setting, a user-defined value can be entered. Ports with the same Key value can participate in the same aggregation group, while ports with

	different keys cannot. The default setting is "Auto"
• Role	The Role shows the LACP activity status. The Active will transmit LACP packets each second, while Passive will wait for a LACP packet from a partner (speak if spoken to).
• Timeout	The Timeout controls the period between BPDU transmissions. Fast will transmit LACP packets each second, while Slow will wait for 30 seconds before sending a LACP packet.
• Prio	The prio controls the priority of the port. If the LACP partner wants to form a larger group than is supported by this device then this parameter will control which ports will be active and which ports will be in a backup role. Lower number means greater priority.

Buttons

: Click to save changes.

: Click to undo any changes made locally and revert to previously saved values.

4.5.3 LACP System Status

This page provides a status overview for all LACP instances. The LACP Status page displays the current LACP aggregation Groups and LACP Port status. The LACP System Status screen in [Figure 4-5-5](#) appears.

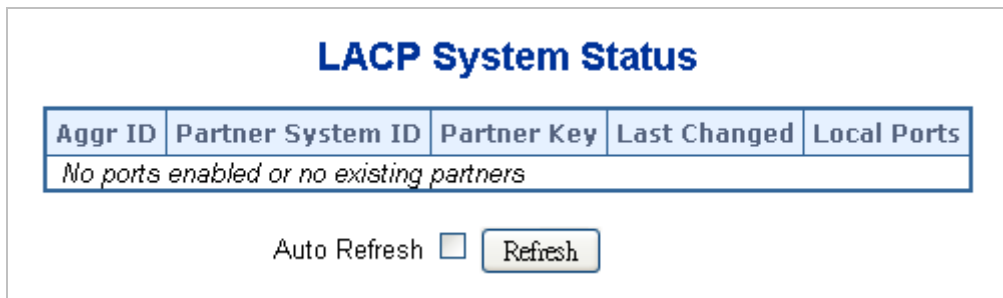

Figure 4-5-5: LACP System Status Page Screenshot

The page includes the following fields:

Object	Description
• Aggr ID	The Aggregation ID associated with this aggregation instance. For LLAG the id is shown as 'isid:aggr-id' and for GLAGs as 'aggr-id'
• Partner System ID	The system ID (MAC address) of the aggregation partner.
• Partner Key	The Key that the partner has assigned to this aggregation ID.
• Last changed	The time since this aggregation changed.

• Local Ports	Shows which ports are a part of this aggregation for this switch. .
----------------------	---

Buttons

: Click to refresh the page immediately.

Auto-refresh : Automatic refresh occurs every 3 seconds.

4.5.4 LACP Port Status

This page provides a status overview for [LACP](#) status for all ports. The LACP Port Status screen in [Figure 4-5-6](#) appears.

Port	LACP	Key	Aggr ID	Partner System ID	Partner Port
1	No	-	-	-	-
2	No	-	-	-	-
3	No	-	-	-	-
4	No	-	-	-	-
5	No	-	-	-	-
6	No	-	-	-	-
7	No	-	-	-	-
8	No	-	-	-	-
9	No	-	-	-	-
10	No	-	-	-	-

Auto-refresh

Figure 4-5-6: LACP Status Page Screenshot

The page includes the following fields:

Object	Description
• Port	The switch port number.
• LACP	'Yes' means that LACP is enabled and the port link is up. 'No' means that LACP is not enabled or that the port link is down. 'Backup' means that the port could not join the aggregation group but will join if other port leaves. Meanwhile it's LACP status is disabled.
• Key	The key assigned to this port. Only ports with the same key can aggregate together.
• Aggr ID	The Aggregation ID assigned to this aggregation group. IDs 1 and 2 are GLAGs while IDs 3-14 are LLAGs.
• Partner System ID	The partners System ID (MAC address).
• Partner Port	The partners port number connected to this port.

Buttons

: Click to refresh the page immediately.

Auto-refresh : Automatic refresh occurs every 3 seconds

4.5.5 LACP Port Statistics

This page provides an overview for LACP statistics for all ports. The LACP Port Statistics screen in [Figure 4-5-7](#) appears.

Port	LACP Received	LACP Transmitted	Discarded	
			Unknown	Illegal
1	0	0	0	0
2	0	0	0	0
3	0	0	0	0
4	0	0	0	0
5	0	0	0	0
6	0	0	0	0
7	0	0	0	0
8	0	0	0	0
9	0	0	0	0
10	0	0	0	0

Auto-refresh

Figure 4-5-7: LACP Statistics Page Screenshot

The page includes the following fields:

Object	Description
• Port	The switch port number.
• LACP Received	Shows how many LACP frames have been sent from each port.
• LACP Transmitted	Shows how many LACP frames have been received at each port.
• Discarded	Shows how many unknown or illegal LACP frames have been discarded at each port.

Buttons

Auto-refresh : Automatic refresh occurs every 3 seconds.

: Click to refresh the page immediately.

: Clears the counters for all ports.

4.6 VLAN

4.6.1 VLAN Overview

A **Virtual Local Area Network (VLAN)** is a network topology configured according to a logical scheme rather than the physical layout. VLAN can be used to combine any collection of LAN segments into an autonomous user group that appears as a single LAN. VLAN also logically segment the network into different broadcast domains so that packets are forwarded only between ports within the VLAN. Typically, a VLAN corresponds to a particular subnet, although not necessarily.

VLAN can enhance performance by conserving bandwidth, and improve security by limiting traffic to specific domains.

A VLAN is a collection of end nodes grouped by logic instead of physical location. End nodes that frequently communicate with each other are assigned to the same VLAN, regardless of where they are physically on the network. Logically, a VLAN can be equated to a broadcast domain, because broadcast packets are forwarded to only members of the VLAN on which the broadcast was initiated.



-
21. No matter what basis is used to uniquely identify end nodes and assign these nodes VLAN membership, packets cannot cross VLAN without a network device performing a routing function between the VLAN.
 22. The Managed Switch supports IEEE 802.1Q VLAN. The port untagging function can be used to remove the 802.1 tag from packet headers to maintain compatibility with devices that are tag-unaware.
 23. The Switch's default is to assign all ports to a single 802.1Q VLAN named DEFAULT_VLAN. As new VLAN is created, the member ports assigned to the new VLAN will be removed from the DEFAULT_VLAN port member list. The DEFAULT_VLAN has a VID = 1.
-

This section has the following items:

- **VLAN Basic Information** Displays VLAN information
- **VLAN Port Configuration** Enables VLAN group
- **VLAN Memberships** Configures the VLAN membership
- **VLAN Membership Status** Displays VLAN membership status
- **VLAN Port Status** Displays VLAN port status
- **Private VLAN** Creates/removes primary or community VLANs
- **Port Isolation** Enables/disables port isolation on port
- **MAC-based VLAN** Configures the MAC-based VLAN entries
- **MAC-based VLAN Status** Displays MAC-based VLAN entries
- **IP Subnet-based VLAN** Configures the IP Subnet-based VLAN entries
- **Protocol-based VLAN** Configures the protocol-based VLAN entries
- **Protocol-based VLAN Membership** Displays the protocol-based VLAN entries

4.6.2 IEEE 802.1Q VLAN

In large networks, routers are used to isolate broadcast traffic for each subnet into separate domains. This Managed Switch provides a similar service at Layer 2 by using VLANs to organize any group of network nodes into separate broadcast domains. VLANs confine broadcast traffic to the originating group, and can eliminate broadcast storms in large networks. This also provides a more secure and cleaner network environment.

An IEEE 802.1Q VLAN is a group of ports that can be located anywhere in the network, but communicate as though they belong to the same physical segment.

VLANs help to simplify network management by allowing you to move devices to a new VLAN without having to change any physical connections. VLANs can be easily organized to reflect departmental groups (such as Marketing or R&D), usage groups (such as e-mail), or multicast groups (used for multimedia applications such as videoconferencing).

VLANs provide greater network efficiency by reducing broadcast traffic, and allow you to make network changes without having to update IP addresses or IP subnets. VLANs inherently provide a high level of network security since traffic must pass through a configured Layer 3 link to reach a different VLAN.

This Managed Switch supports the following VLAN features:

- Up to 255 VLANs based on the IEEE 802.1Q standard
- Port overlapping, allowing a port to participate in multiple VLANs
- End stations can belong to multiple VLANs
- Passing traffic between VLAN-aware and VLAN-unaware devices
- Priority tagging

■ IEEE 802.1Q Standard

IEEE 802.1Q (tagged) VLAN are implemented on the Switch. 802.1Q VLAN require tagging, which enables them to span the entire network (assuming all switches on the network are IEEE 802.1Q-compliant).

VLAN allow a network to be segmented in order to reduce the size of broadcast domains. All packets entering a VLAN will only be forwarded to the stations (over IEEE 802.1Q enabled switches) that are members of that VLAN, and this includes broadcast, multicast and unicast packets from unknown sources.

VLAN can also provide a level of security to your network. IEEE 802.1Q VLAN will only deliver packets between stations that are members of the VLAN. Any port can be configured as either **tagging** or **untagging**:

- The untagging feature of IEEE 802.1Q VLAN allows VLAN to work with legacy switches that don't recognize VLAN tags in packet headers.
- The tagging feature allows VLAN to span multiple 802.1Q-compliant switches through a single physical connection and allows Spanning Tree to be enabled on all ports and work normally.

Some relevant terms:

- **Tagging** - The act of putting 802.1Q VLAN information into the header of a packet.

- **Untagging** - The act of stripping 802.1Q VLAN information out of the packet header.

802.1Q VLAN Tags

The figure below shows the 802.1Q VLAN tag. There are four additional octets inserted after the source MAC address. Their presence is indicated by a value of **0x8100** in the Ether Type field. When a packet's Ether Type field is equal to 0x8100, the packet carries the IEEE 802.1Q/802.1p tag. The tag is contained in the following two octets and consists of 3 bits of user priority, 1 bit of Canonical Format Identifier (CFI - used for encapsulating Token Ring packets so they can be carried across Ethernet backbones), and 12 bits of **VLAN ID (VID)**. The 3 bits of user priority are used by 802.1p. The VID is the VLAN identifier and is used by the 802.1Q standard. Because the VID is 12 bits long, 4094 unique VLAN can be identified.

The tag is inserted into the packet header making the entire packet longer by 4 octets. All of the information originally contained in the packet is retained.

802.1Q Tag

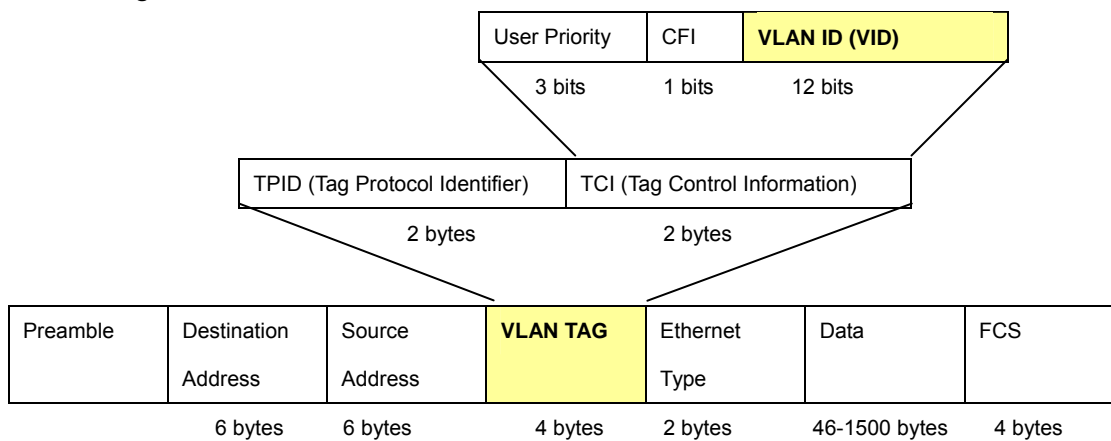

The Ether Type and VLAN ID are inserted after the MAC source address, but before the original Ether Type/Length or Logical Link Control. Because the packet is now a bit longer than it was originally, the Cyclic Redundancy Check (CRC) must be recalculated.

Adding an IEEE802.1Q Tag

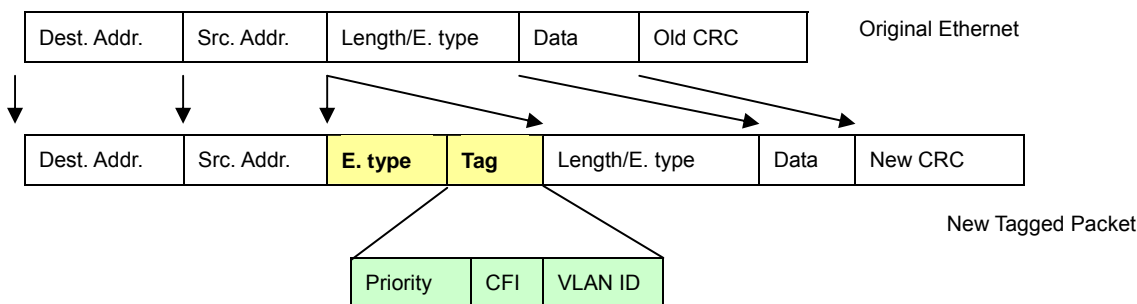

■ Port VLAN ID

Packets that are tagged (are carrying the 802.1Q VID information) can be transmitted from one 802.1Q compliant network device to another with the VLAN information intact. This allows 802.1Q VLAN to span network devices (and indeed, the entire network – if all network devices are 802.1Q compliant).

Every physical port on a switch has a PVID. 802.1Q ports are also assigned a PVID, for use within the switch. If no VLAN are defined on the switch, all ports are then assigned to a default VLAN with a PVID equal to 1. Untagged packets are assigned the PVID of the port on which they were received. Forwarding decisions are based upon this PVID, in so far as VLAN are concerned. Tagged packets are forwarded according to the VID contained within the tag. Tagged packets are also assigned a PVID, but the PVID is not used to make packet forwarding decisions, the VID is.

Tag-aware switches must keep a table to relate PVID within the switch to VID on the network. The switch will compare the VID of a packet to be transmitted to the VID of the port that is to transmit the packet. If the two VID are different the switch will drop the packet. Because of the existence of the PVID for untagged packets and the VID for tagged packets, tag-aware and tag-unaware network devices can coexist on the same network.

A switch port can have only one PVID, but can have as many VID as the switch has memory in its VLAN table to store them.

Because some devices on a network may be tag-unaware, a decision must be made at each port on a tag-aware device before packets are transmitted – should the packet to be transmitted have a tag or not? If the transmitting port is connected to a tag-unaware device, the packet should be untagged. If the transmitting port is connected to a tag-aware device, the packet should be tagged.

■ Default VLANs

The Switch initially configures one VLAN, VID = 1, called "**default**." The factory default setting assigns all ports on the Switch to the "**default**". As new VLAN are configured in Port-based mode, their respective member ports are removed from the "**default**".

■ Assigning Ports to VLANs

Before enabling VLANs for the switch, you must first assign each port to the VLAN group(s) in which it will participate. By default all ports are assigned to VLAN 1 as untagged ports. Add a port as a tagged port if you want it to carry traffic for one or more VLANs, and any intermediate network devices or the host at the other end of the connection supports VLANs. Then assign ports on the other VLAN-aware network devices along the path that will carry this traffic to the same VLAN(s), either manually or dynamically using GVRP. However, if you want a port on this switch to participate in one or more VLANs, but none of the intermediate network devices nor the host at the other end of the connection supports VLANs, then you should add this port to the VLAN as an untagged port.



VLAN-tagged frames can pass through VLAN-aware or VLAN-unaware network interconnection devices, but the VLAN tags should be stripped off before passing it on to any end-node host that does not support VLAN tagging.

■ VLAN Classification

When the switch receives a frame, it classifies the frame in one of two ways. If the frame is untagged, the switch assigns the frame to an associated VLAN (based on the default VLAN ID of the receiving port). But if the frame is tagged, the switch uses the tagged VLAN ID to identify the port broadcast domain of the frame.

■ Port Overlapping

Port overlapping can be used to allow access to commonly shared network resources among different VLAN groups, such as file servers or printers. Note that if you implement VLANs which do not overlap, but still need to communicate, you can connect them by enabled routing on this switch.

■ Untagged VLANs

Untagged (or static) VLANs are typically used to reduce broadcast traffic and to increase security. A group of network users assigned to a VLAN form a broadcast domain that is separate from other VLANs configured on the switch. Packets are forwarded only between ports that are designated for the same VLAN. Untagged VLANs can be used to manually isolate user groups or subnets.

4.6.3 VLAN Basic Information

The VLAN Basic Information page displays basic information on the VLAN type supported by the Managed Switch.

The VLAN Basic Information screen in [Figure 4-6-1](#) appears.

VLAN Basic Information	
Mode	IEEE 802.1Q
Maximum VLAN ID	4095
Maximum Number of Supported VLANs	255
Current Number of VLANs	1
VLAN Learning	IVL
Configurable PVID Tagging	Yes

Figure 4-6-1: VLAN Basic Information Page Screenshot

The page includes the following fields:

Object	Description
<ul style="list-style-type: none"> • Mode 	Display the current VLAN mode used by this Managed Switch <ul style="list-style-type: none"> ■ Port-Based ■ IEEE 802.1Q VLAN
<ul style="list-style-type: none"> • Maximum VLAN ID 	Maximum VLAN ID recognized by this Industrial Managed Switch.
<ul style="list-style-type: none"> • Maximum Number of Supported VLANs 	Maximum number of VLANs that can be configured on this Industrial Managed Switch.
<ul style="list-style-type: none"> • Current number of VLANs 	Display the current number of VLANs

• VLAN Learning	Display the VLAN learning mode. The Industrial Managed Switch supports IVL (IVL Independent vlan learning).
• Configurable PVID Tagging	Indicates whether or not configurable PVID tagging is implemented.

4.6.4 VLAN Port Configuration

This page is used for configuring the Managed Switch port VLAN. The VLAN per Port Configuration page contains fields for managing ports that are part of a VLAN. The port default VLAN ID (PVID) is configured on the VLAN Port Configuration page. All untagged packets arriving to the device are tagged by the ports PVID.

Understand nomenclature of the Switch

■ IEEE 802.1Q Tagged and Untagged

Every port on an 802.1Q compliant switch can be configured as tagged or untagged.

- **Tagged:** Ports with tagging enabled will put the VID number, priority and other VLAN information into the header of all packets that flow into those ports. If a packet has previously been tagged, the port will not alter the packet, thus keeping the VLAN information intact. The VLAN information in the tag can then be used by other 802.1Q compliant devices on the network to make packet-forwarding decisions.
- **Untagged:** Ports with untagging enabled will strip the 802.1Q tag from all packets that flow into those ports. If the packet doesn't have an 802.1Q VLAN tag, the port will not alter the packet. Thus, all packets received by and forwarded by an untagging port will have no 802.1Q VLAN information. (Remember that the PVID is only used internally within the Switch). Untagging is used to send packets from an 802.1Q-compliant network device to a non-compliant network device.

Frame Income / Frame Leave	Income Frame is tagged	Income Frame is untagged
Leave port is tagged	Frame remains tagged	Tag is inserted
Leave port is untagged	Tag is removed	Frame remain untagged

Table 4-6-1 Ingress/Egress port with VLAN VID Tag/Untag table

■ IEEE 802.1Q Tunneling (Q-in-Q)

IEEE 802.1Q Tunneling (QinQ) is designed for service providers carrying traffic for multiple customers across their networks. QinQ tunneling is used to maintain customer-specific VLAN and Layer 2 protocol configurations even when different customers use the same internal VLAN IDs. This is accomplished by inserting **Service Provider VLAN (SPVLAN)** tags into the customer's frames when they enter the service provider's network, and then stripping the tags when the frames leave the network.

A service provider's customers may have specific requirements for their internal VLAN IDs and number of VLANs supported. VLAN ranges required by different customers in the same service-provider network might easily overlap, and traffic passing through the infrastructure might be mixed. Assigning a unique range of VLAN IDs to each customer would restrict customer configurations, require intensive processing of VLAN mapping tables, and could easily exceed the maximum VLAN limit of 4095.

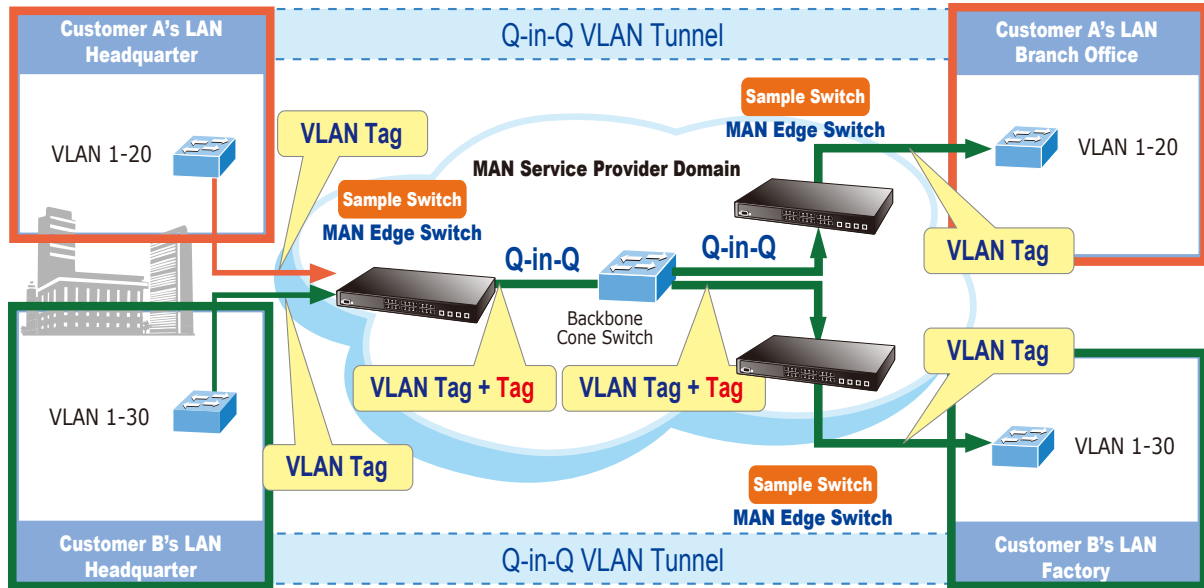

The **Industrial Managed Switch** supports multiple VLAN tags and can therefore be used in MAN applications as a provider bridge, aggregating traffic from numerous independent customer LANs into the **MAN (Metro Access Network)** space. One of the purposes of the provider bridge is to recognize and use VLAN tags so that the VLANs in the MAN space can be used independent of the customers' VLANs. This is accomplished by adding a VLAN tag with a MAN-related VID for frames entering the MAN. When leaving the MAN, the tag is stripped and the original VLAN tag with the customer-related VID is again available.

This provides a tunneling mechanism to connect remote customer VLANs through a common MAN space without interfering with the VLAN tags. All tags use EtherType **0x8100** or **0x88A8**, where 0x8100 is used for customer tags and 0x88A8 are used for service provider tags.

In cases where a given service VLAN only has two member ports on the switch, the learning can be disabled for the particular VLAN and can therefore rely on flooding as the forwarding mechanism between the two ports. This way, the MAC table requirements is reduced.

VLAN Port Configuration

The VLAN Port Configuration screen in Figure 4-6-2 appears.

VLAN Port Configuration

Mode | IEEE 802.1Q ▾

If Untag VID = 0 ,then disable untag VID function.

Port	PVID	Untag VID	Ingress Filtering	Acceptable Frame Type	Link Type	Q-in-Q Mode	Set out layer VLAN tag ether type
*	1	0	<input type="checkbox"/>	<All> ▾	<All> ▾	<All> ▾	<All> ▾
1	1	0	<input type="checkbox"/>	All ▾	UnTag ▾	Disable ▾	802.1Q Tag ▾
2	1	0	<input type="checkbox"/>	All ▾	UnTag ▾	Disable ▾	802.1Q Tag ▾
3	1	0	<input type="checkbox"/>	All ▾	UnTag ▾	Disable ▾	802.1Q Tag ▾
4	1	0	<input type="checkbox"/>	All ▾	UnTag ▾	Disable ▾	802.1Q Tag ▾
5	1	0	<input type="checkbox"/>	All ▾	UnTag ▾	Disable ▾	802.1Q Tag ▾
6	1	0	<input type="checkbox"/>	All ▾	UnTag ▾	Disable ▾	802.1Q Tag ▾
7	1	0	<input type="checkbox"/>	All ▾	UnTag ▾	Disable ▾	802.1Q Tag ▾
8	1	0	<input type="checkbox"/>	All ▾	UnTag ▾	Disable ▾	802.1Q Tag ▾
9	1	0	<input type="checkbox"/>	All ▾	UnTag ▾	Disable ▾	802.1Q Tag ▾
10	1	0	<input type="checkbox"/>	All ▾	UnTag ▾	Disable ▾	802.1Q Tag ▾

Save | Reset

Figure 4-6-2 : VLAN Port Configuration Page Screenshot

The page includes the following fields:

Object	Description
• Port	This is the logical port number for this row.
• PVID	Allows to assign PVID to selected port. The range for the PVID is 1-4094. The PVID will be inserted into all untagged frames entering the ingress port. The PVID must as the same as the VLAN ID in that the port belongs to VLAN group, or the untagged traffic will be dropped.
Ingress Filtering	Enable ingress filtering for a port by checking the box. This parameter affects VLAN ingress processing. If ingress filtering is enabled and the ingress port is not a member of the classified VLAN of the frame, the frame is discarded. By default, ingress filtering is disabled (no checkmark).
• Accept Frame Type	Determines whether the port accepts all frames or only tagged frames. This parameter affects VLAN ingress processing. If the port only accepts tagged frames, untagged frames received on the port are discarded. By default, the field is set to All.

<p>24. Link Type</p>	<p>Allow 802.1Q Untagged or Tagged VLAN for selected port.</p> <p>When adding a VLAN to selected port, it tells the switch whether to keep or remove the tag from a frame on egress.</p> <ul style="list-style-type: none"> ■ Untag: outgoing frames without VLAN-Tagged. ■ Tagged: outgoing frames with VLAN-Tagged.
<p>25. Q-in-Q Mode</p>	<p>Sets the Managed Switch to QinQ mode, and allows the QinQ tunnel port to be configured. The default is for the Managed Switch to function in Disable mode.</p> <ul style="list-style-type: none"> ■ Disable: The port operates in its normal VLAN mode. (This is the default.) ■ MAN Port: Configures IEEE 802.1Q tunneling (QinQ) for an uplink port to another device within the service provider network. ■ Customer Port: Configures IEEE 802.1Q tunneling (QinQ) for a client access port to segregate and preserve customer VLAN IDs for traffic crossing the service provider network.
<p>Set Out layer VLAN tag ether type</p>	<p>The Tag Protocol Identifier (TPID) specifies the ethertype of incoming packets on a tunnel access port.</p> <ul style="list-style-type: none"> ■ 802.1Q Tag: 8100 ■ vMAN Tag: 88A8 <p>Default : 802.1Q Tag</p>



The port must be a member of the same VLAN as the Port VLAN ID.

Buttons



: Click to save changes.



: Click to undo any changes made locally and revert to previously saved values.

4.6.5 VLAN Membership

■ Adding Static Members to VLANs (VLAN Index)

Use the VLAN Static Table to configure port members for the selected VLAN index. The VLAN membership configuration for the selected stack switch / unit switch can be monitored and modified here. Up to 255 VLANs are supported. This page allows for adding and deleting VLANs as well as adding and deleting port members of each VLAN. The VLAN Membership screen in Figure 4-6-3 appears.

VLAN Membership Configuration

Start from VLAN with entries per page.

Delete	VLAN ID	VLAN Name	Port Members											
			1	2	3	4	5	6	7	8	9	10		
<input type="checkbox"/>	1	default	✓	✓	✓	✓	✓	✓	✓	✓	✓	✓	✓	✓

Figure 4-6-3: VLAN Membership Configuration Page Screenshot

The page includes the following fields:

Object	Description
<ul style="list-style-type: none"> • Delete 	To delete a VLAN entry, check this box. The entry will be deleted on all stack switch units during the next Save.
<ul style="list-style-type: none"> • VLAN ID 	Indicates the ID of this particular VLAN.
<ul style="list-style-type: none"> • VLAN Name 	Indicates the name of the VLAN. Maximum length of the VLAN Name String is 32. VLAN Name can only contain alphabets or numbers. VLAN name should contain atleast one alphabet. VLAN name can be edited for the existing VLAN entries or it can be added to the new entries.
<ul style="list-style-type: none"> • Port Members 	A row of check boxes for each port is displayed for each VLAN ID. To include a port in a VLAN, check the box. To remove or exclude the port from the VLAN, make sure the box is unchecked. By default, no ports are members, and all boxes are unchecked.
<ul style="list-style-type: none"> • Add New VLAN 	Click to add a new VLAN ID. An empty row is added to the table, and the VLAN can be configured as needed. Legal values for a VLAN ID are 1 through 4095. The VLAN is enabled on the selected stack switch unit when you click on "Save". The VLAN is thereafter present on the other stack switch units, but with no port members.

	<p>A VLAN without any port members on any stack unit will be deleted when you click "Save".</p> <p>The button can be used to undo the addition of new VLANs.</p>
--	--

Buttons

- : Click to add new VLAN.
- : Click to save changes.
- : Click to undo any changes made locally and revert to previously saved values.
- : Refreshes the displayed table starting from the "VLAN ID" input fields.
- : Updates the table starting from the first entry in the VLAN Table, i.e. the entry with the lowest VLAN ID.
- : Updates the table, starting with the entry after the last entry currently displayed.

4.6.6 VLAN Membership Status

This page provides an overview of membership status for VLAN users. The VLAN Membership Status screen in [Figure 4-6-4](#) appears.

VLAN Membership Status for Combined Users

Start from VLAN with entries per page.

VLAN ID	Port Members									
	1	2	3	4	5	6	7	8	9	10
1	<input checked="" type="checkbox"/>	<input checked="" type="checkbox"/>	<input checked="" type="checkbox"/>	<input checked="" type="checkbox"/>	<input checked="" type="checkbox"/>	<input checked="" type="checkbox"/>	<input checked="" type="checkbox"/>	<input checked="" type="checkbox"/>	<input checked="" type="checkbox"/>	<input checked="" type="checkbox"/>

Auto-refresh

Figure 4-6-4: VLAN Membership Status for Static User Page Screenshot

The page includes the following fields:

Object	Description
<ul style="list-style-type: none"> • VLAN ID 	Indicates the ID of this particular VLAN.
<ul style="list-style-type: none"> • Port Members 	The VLAN Membership Status Page shall show the current VLAN port members

	<p>for all VLANs configured by a selected VLAN User (selection shall be allowed by a Combo Box). When ALL VLAN Users is selected, it shall show this information for all the VLAN Users, and this is the default. VLAN membership allows the frames Classified to the VLAN ID to be forwarded to the respective VLAN member ports.</p>
<ul style="list-style-type: none"> • VLAN User 	<p>A VLAN User is a module that uses services of the VLAN management functionality to configure VLAN memberships and VLAN port configuration such as PVID and UVID. Currently we support following VLAN :</p> <ul style="list-style-type: none"> ■ CLI/Web/SNMP : This is referred as static. ■ NAS : NAS provides port-based authentication, which involves communications between a Supplicant, Authenticator, and an Authentication Server. ■ MVR : MVR is used to eliminate the need to duplicate multicast traffic for subscribers in each VLAN. Multicast traffic for all channels is sent only on a single (multicast) VLAN. ■ Voice VLAN : Voice VLAN is a VLAN configured specially for voice traffic typically originating from IP phones. ■ MSTP : The 802.1s Multiple Spanning Tree protocol (MSTP) uses VLANs to create multiple spanning trees in a network, which significantly improves network resource utilization while maintaining a loop-free environment.

Buttons

 : Select VLAN Users from this drop down list.

Auto-refresh : Check this box to enable an automatic refresh of the page at regular intervals.

 : Click to refresh the page immediately.

 : Updates the table starting from the first entry in the VLAN Table, i.e. the entry with the lowest VLAN ID.

 : Updates the table, starting with the entry after the last entry currently displayed.

4.6.7 VLAN Port Status

This page provides VLAN Port Staus. The VLAN Port Status screen in [Figure 4-6-5](#) appears.

Port	PVID	Port Type	Ingress Filtering	Frame Type	Tx Tag	UVID	Conflicts
1	1	UnAware	Disabled	All	Untag_this	1	No
2	1	UnAware	Disabled	All	Untag_this	1	No
3	1	UnAware	Disabled	All	Untag_this	1	No
4	1	UnAware	Disabled	All	Untag_this	1	No
5	1	UnAware	Disabled	All	Untag_this	1	No
6	1	UnAware	Disabled	All	Untag_this	1	No
7	1	UnAware	Disabled	All	Untag_this	1	No
8	1	UnAware	Disabled	All	Untag_this	1	No
9	1	UnAware	Disabled	All	Untag_this	1	No
10	1	UnAware	Disabled	All	Untag_this	1	No

Figure 4-6-5: VLAN Port Status for Static User Page Screenshot

The page includes the following fields:

Object	Description
• Port	The logical port for the settings contained in the same row.
• PVID	Shows the VLAN identifier for that port. The allowed values are 1 through 4095. The default value is 1.
• Port Type	Shows the Port Type. Port type can be any of Unaware, C-port, S-port, Custom S-port. If Port Type is Unaware, all frames are classified to the Port VLAN ID and tags are not removed. C-port is Customer Port. S-port is Service port. Custom S-port is S-port with Custom TPID.
• Ingress Filtering	Shows the ingress filtering for a port. This parameter affects VLAN ingress processing. If ingress filtering is enabled and the ingress port is not a member of the classified VLAN of the frame, the frame is discarded.
• Frame Type	Shows whether the port accepts all frames or only tagged frames. This parameter affects VLAN ingress processing. If the port only accepts tagged frames, untagged frames received on that port are discarded.
• Tx Tag	Shows egress filtering frame status whether tagged or untagged.
• UVID	Shows UVID (untagged VLAN ID). Port's UVID determines the packet's behavior at the egress side.
• Conflicts	Shows status of Conflicts whether exists or Not. When a Volatile VLAN User requests to set VLAN membership or VLAN port configuration, the following

	<p>conflicts can occur:</p> <ul style="list-style-type: none"> Functional Conflicts between feature. Conflicts due to hardware limitation. Direct conflict between user modules.
--	---

Buttons

Static : Select VLAN Users from this drop down list.

Auto-refresh : Check this box to refresh the page automatically. Automatic refresh occurs every 3 seconds.

: Click to refresh the page immediately.

4.6.8 Private VLAN

The Private VLAN membership configurations for the switch can be monitored and modified here. Private VLANs can be added or deleted here. Port members of each Private VLAN can be added or removed here.

Private VLANs are based on the source port mask, and there are no connections to VLANs. This means that VLAN IDs and Private VLAN IDs can be identical.

A port must be a member of both a VLAN and a Private VLAN to be able to forward packets. By default, all ports are VLAN unaware and members of VLAN 1 and Private VLAN 1.

A VLAN unaware port can only be a member of one VLAN, but it can be a member of multiple Private VLANs.

The Private VLAN screen in [Figure 4-6-6](#) appears.

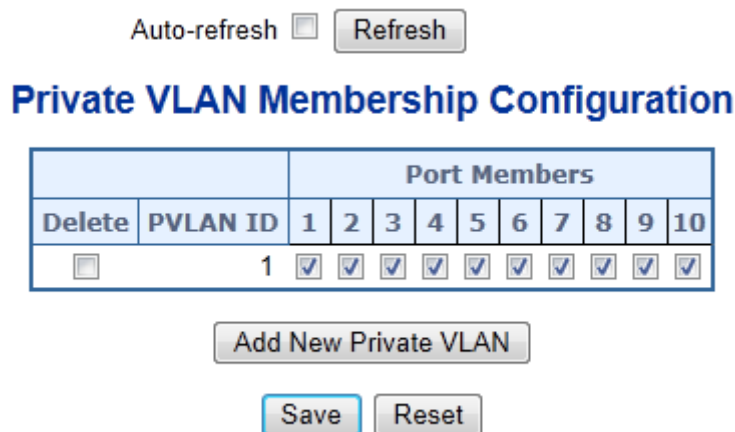

Figure 4-6-6: Private VLAN Membership Configuration Page Screenshot

The page includes the following fields:

Object	Description
<ul style="list-style-type: none"> • Delete 	To delete a private VLAN entry, check this box. The entry will be deleted during the next Save.
<ul style="list-style-type: none"> • Private VLAN ID 	Indicates the ID of this particular private VLAN.
<ul style="list-style-type: none"> • Port Members 	A row of check boxes for each port is displayed for each private VLAN ID. To include a port in a Private VLAN, check the box. To remove or exclude the port from the Private VLAN, make sure the box is unchecked. By default, no ports are members, and all boxes are unchecked.

Buttons

: Click to add new VLAN.

: Click to save changes.

: Click to undo any changes made locally and revert to previously saved values.

Auto-refresh : Check this box to refresh the page automatically. Automatic refresh occurs every 3 seconds.

: Click to refresh the page immediately.

4.6.9 Port Isolation

Overview

When a VLAN is configured to be a private VLAN, communication between ports within that VLAN can be prevented. Two application examples are provided in this section:

- Customers connected to an ISP can be members of the same VLAN, but they are not allowed to communicate with each other within that VLAN.
- Servers in a farm of web servers in a Demilitarized Zone (DMZ) are allowed to communicate with the outside world and with database servers on the inside segment, but are not allowed to communicate with each other

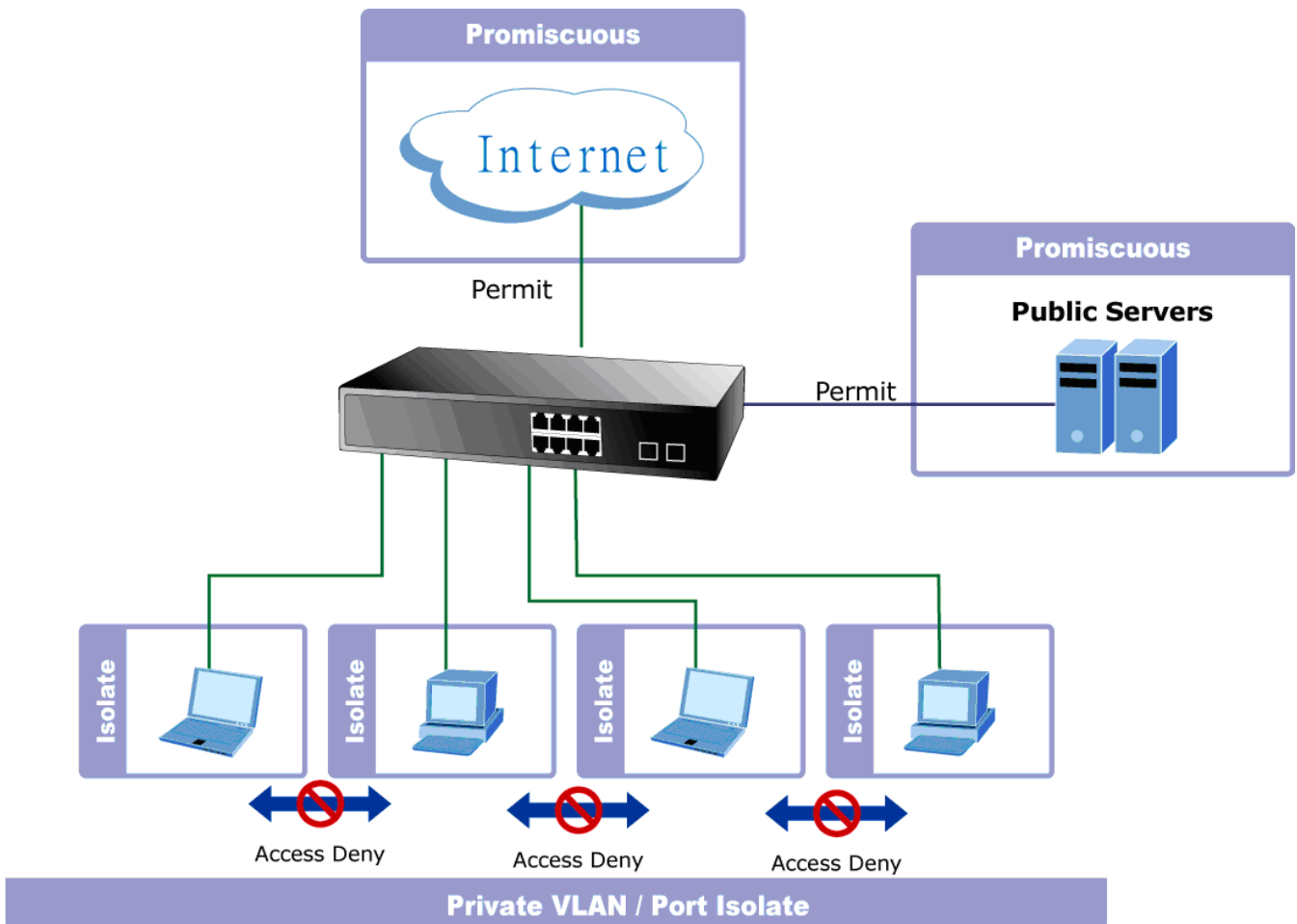

For private VLANs to be applied, the switch must first be configured for standard VLAN operation. When this is in place, one or more of the configured VLANs can be configured as private VLANs. Ports in a private VLAN fall into one of these two groups:

■ Promiscuous ports

- Ports from which traffic can be forwarded to all ports in the private VLAN
- Ports which can receive traffic from all ports in the private VLAN

■ Isolated ports

- Ports from which traffic can only be forwarded to promiscuous ports in the private VLAN
- Ports which can receive traffic from only promiscuous ports in the private VLAN

The configuration of promiscuous and isolated ports applies to all private VLANs. When traffic comes in on a promiscuous port in a private VLAN, the VLAN mask from the VLAN table is applied. When traffic comes in on an isolated port, the private VLAN mask is applied in addition to the VLAN mask from the VLAN table. This reduces the ports to which forwarding can be done to just the promiscuous ports within the private VLAN.

This page is used for enabling or disabling port isolation on ports in a Private VLAN. A port member of a VLAN can be isolated to other isolated ports on the same VLAN and Private VLAN. The Port Isolation screen in [Figure 4-6-7](#) appears.

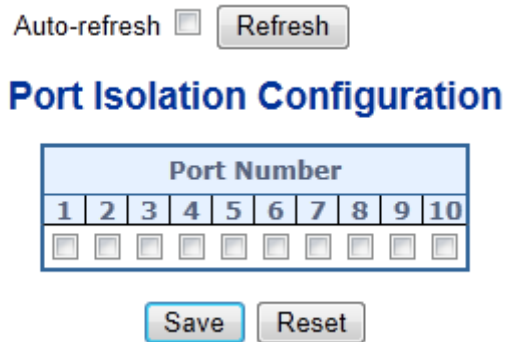

Figure 4-6-7: Port Isolation Configuration Page Screenshot

The page includes the following fields:

Object	Description
<ul style="list-style-type: none"> • Port Members 	A check box is provided for each port of a private VLAN. When checked, port isolation is enabled on that port. When unchecked, port isolation is disabled on that port. By default, port isolation is disabled on all ports.

Buttons

Save: Click to save changes.

Reset: Click to undo any changes made locally and revert to previously saved values.

Auto-refresh : Check this box to refresh the page automatically. Automatic refresh occurs every 3 seconds.

Refresh: Click to refresh the page immediately.

4.6.10 VLAN setting example:

- Separate VLAN
- 802.1Q VLAN Trunk
- Port Isolate

4.6.10.1 Two separate 802.1Q VLAN

The diagram shows how the Industrial Managed Switch handle Tagged and Untagged traffic flow for two VLANs. VLAN Group 2 and VLAN Group 3 are separated VLAN. Each VLAN isolates network traffic so only members of the VLAN receive traffic from the same VLAN members. The screen in [Figure 4-6-8](#) appears and [Table 4-1](#) describes the port configuration of the **Industrial Managed Switch**.

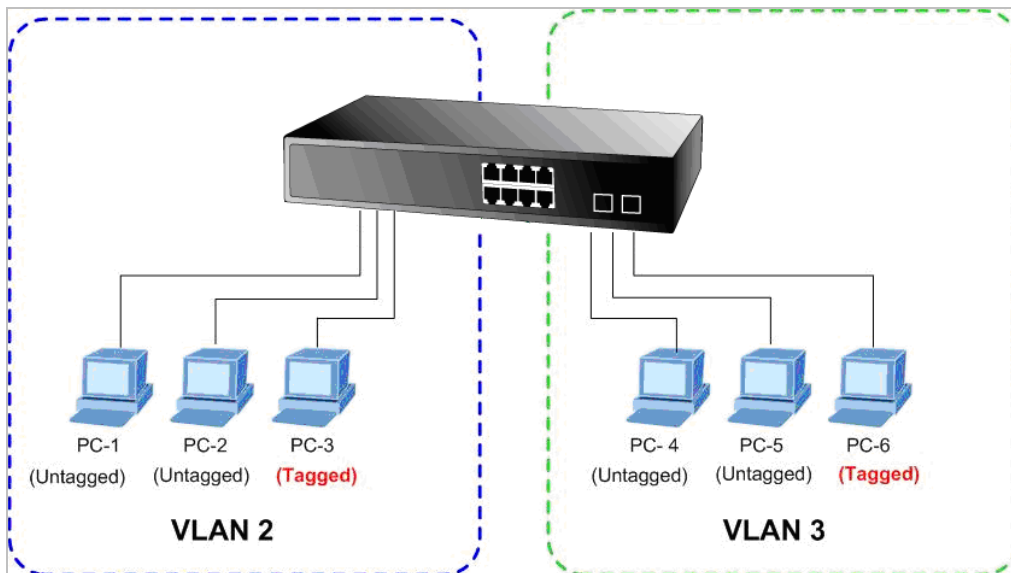

Figure 4-6-8: Two Separate VLAN Diagram

VLAN Group	VID	Untagged Members	Tagged Members
VLAN Group 1	1	Port-7 ~ Port-10	N/A
VLAN Group 2	2	Port-1,Port-2	Port-3
VLAN Group 3	3	Port-4,Port-5	Port-6

Table 4-1: VLAN and Port Configuration

The scenario described as follow:

■ **Untagged packet entering VLAN 2**

1. While [PC-1] transmitting an **untagged** packet enters **Port-1**, the Managed Switch will tag it with a **VLAN Tag=2**. [PC-2] and [PC-3] will receive the packet through **Port-2** and **Port-3**.
2. [PC-4],[PC-5] and [PC-6] receive no packet.

3. While the packet leaves **Port-2**, it will be stripped away its tag becoming an **untagged** packet.
4. While the packet leaves **Port-3**, it will keep as a **tagged** packet with **VLAN Tag=2**.

■ **Tagged packet entering VLAN 2**

5. While **[PC-3]** transmit a **tagged** packet with **VLAN Tag=2** enters **Port-3**, **[PC-1]** and **[PC-2]** will receive the packet through **Port-1** and **Port-2**.
6. While the packet leaves **Port-1** and **Port-2**, it will be stripped away its tag becoming an **untagged** packet.

■ **Untagged packet entering VLAN 3**

1. While **[PC-4]** transmit an **untagged** packet enters **Port-4**, the switch will tag it with a **VLAN Tag=3**. **[PC-5]** and **[PC-6]** will receive the packet through **Port-5** and **Port-6**.
2. While the packet leaves **Port-5**, it will be stripped away its tag becoming an **untagged** packet.
3. While the packet leaves **Port-6**, it will keep as a **tagged** packet with **VLAN Tag=3**.



For this example, just set VLAN Group 1 as default VLAN, but only focus on VLAN 2 and VLAN 3 traffic flow

Setup steps

1. Create VLAN Group

Set VLAN Group 1 = Default-VLAN with VID (VLAN ID) =1

Add two VLANs – VLAN 2 and VLAN 3

VLAN Group 2 with VID=2

VLAN Group 3 with VID=3

2. Assign VLAN Member :

VLAN 2 : Port-1,Port-2 and Port-3

VLAN 3 : Port-4, Port-5 and Port-6

VLAN 1 : All other ports – Port-7~Port-24

3. Remove VLAN Member for VLAN 1:

Remember to remove Port 1 – Port 6 from VLAN 1 membership, since Port 1 – Port 6 have been assigned to VLAN 2 and VLAN 3.

Delete	VLAN ID	VLAN Name	Port Members											
			1	2	3	4	5	6	7	8	9	10		
<input type="checkbox"/>	1	default	<input checked="" type="checkbox"/>	<input checked="" type="checkbox"/>	<input checked="" type="checkbox"/>	<input checked="" type="checkbox"/>	<input checked="" type="checkbox"/>	<input checked="" type="checkbox"/>	<input checked="" type="checkbox"/>	<input checked="" type="checkbox"/>	<input checked="" type="checkbox"/>	<input checked="" type="checkbox"/>	<input checked="" type="checkbox"/>	<input checked="" type="checkbox"/>
Delete	2	VLAN2	<input checked="" type="checkbox"/>	<input checked="" type="checkbox"/>	<input checked="" type="checkbox"/>	<input type="checkbox"/>	<input type="checkbox"/>	<input type="checkbox"/>	<input type="checkbox"/>	<input type="checkbox"/>	<input type="checkbox"/>	<input type="checkbox"/>	<input type="checkbox"/>	<input type="checkbox"/>
Delete	3	VLAN3	<input type="checkbox"/>	<input type="checkbox"/>	<input type="checkbox"/>	<input checked="" type="checkbox"/>	<input checked="" type="checkbox"/>	<input checked="" type="checkbox"/>	<input type="checkbox"/>	<input type="checkbox"/>	<input type="checkbox"/>	<input type="checkbox"/>	<input type="checkbox"/>	<input type="checkbox"/>

Figure 4-6-9: Add new VLAN group, assign VLAN members to VLAN 2 and VLAN 3 and remove specified ports from VLAN1 member



It's important to remove the VLAN members from VLAN 1 configuration. Or the ports would become overlap setting. (About the overlapped VLAN configuration, see next VLAN configure sample)

4. Assign PVID to each port:

Port-1,Port-2 and Port-3 : PVID=2

Port-4,Port-5 and Port-6 : PVID=3

Port-7~Port-24 : PVID=1

5. Enable VLAN Tag for specific ports

Link Type: Port-3 (VLAN-2) and Port-6 (VLAN-3)

The Per Port VLAN configuration in Figure 4-6-10 appears.

Port	PVID	Ingress Filtering	Acceptable Frame Type	Link Type	Q-in-Q Mode	Set out layer VLAN tag ether type
1	2	<input type="checkbox"/>	All	UnTag	Disable	802.1Q Tag
2	2	<input type="checkbox"/>	All	UnTag	Disable	802.1Q Tag
3	2	<input type="checkbox"/>	All	Tagged	Disable	802.1Q Tag
4	3	<input type="checkbox"/>	All	UnTag	Disable	802.1Q Tag
5	3	<input type="checkbox"/>	All	UnTag	Disable	802.1Q Tag
6	3	<input type="checkbox"/>	All	Tagged	Disable	802.1Q Tag
7	1	<input type="checkbox"/>	All	UnTag	Disable	802.1Q Tag
8	1	<input type="checkbox"/>	All	UnTag	Disable	802.1Q Tag
9	1	<input type="checkbox"/>	All	UnTag	Disable	802.1Q Tag
10	1	<input type="checkbox"/>	All	UnTag	Disable	802.1Q Tag

Figure 4-6-10: Port 1-Port 6 VLAN Configuration

4.6.10.2 VLAN Trunking between two 802.1Q aware Switch

In most cases, it is used for “Uplink” to other switches. VLANs are separated at different switches, but they need to access with other switches within the same VLAN group. The screen in [Figure 4-6-11](#) appears.

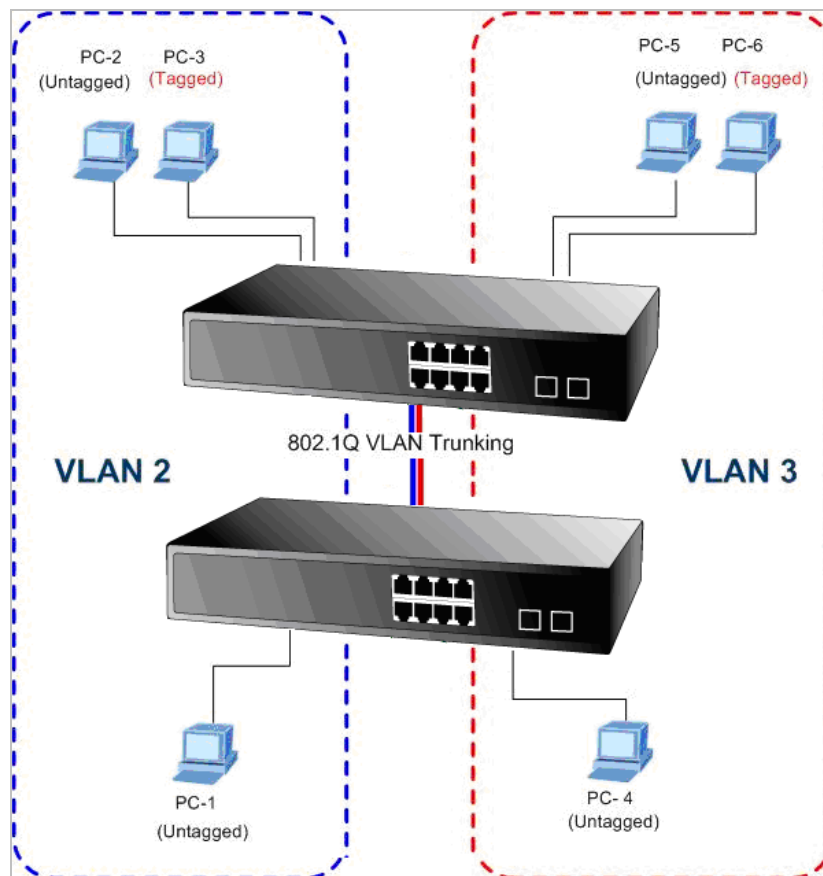

Setup steps

1. Create VLAN Group

Set VLAN Group 1 = Default-VLAN with VID (VLAN ID) =1

Add two VLANs – VLAN 2 and VLAN 3

VLAN Group 2 with VID=2

VLAN Group 3 with VID=3

2. Assign VLAN Member :

VLAN 2 : Port-1,Port-2 and Port-3

VLAN 3 : Port-4, Port-5 and Port-6

VLAN 1 : All other ports – Port-7~Port-24

As to the VLAN ports connecting to the hosts, please refer to 4.6.10.1 examples. The following steps will focus on the VLAN **Trunk port** configuration.

1. Specify **Port-8** to be the 802.1Q VLAN **Trunk port**.
2. Assign **Port-8** to both **VLAN 2** and **VLAN 3** at the VLAN Member configuration page.

- Define a **VLAN 1** as a “**Public Area**” that overlaps with both **VLAN 2 members** and **VLAN 3 members**.
- Assign the VLAN Trunk Port to be the member of each VLAN, which wants to be aggregated. For this sample, assign **Port-8** to **VLAN 2** and **VLAN 3** member port. The screen in [Figure 4-6-12](#) appears.

Delete	VLAN ID	VLAN Name	Port Members											
			1	2	3	4	5	6	7	8	9	10		
<input type="checkbox"/>	1	default	<input checked="" type="checkbox"/>	<input checked="" type="checkbox"/>	<input checked="" type="checkbox"/>	<input checked="" type="checkbox"/>	<input checked="" type="checkbox"/>	<input checked="" type="checkbox"/>	<input checked="" type="checkbox"/>	<input checked="" type="checkbox"/>	<input checked="" type="checkbox"/>	<input checked="" type="checkbox"/>	<input checked="" type="checkbox"/>	<input checked="" type="checkbox"/>
<input type="checkbox"/>	2	VLAN2	<input checked="" type="checkbox"/>	<input checked="" type="checkbox"/>	<input checked="" type="checkbox"/>	<input type="checkbox"/>	<input type="checkbox"/>	<input type="checkbox"/>	<input type="checkbox"/>	<input type="checkbox"/>	<input checked="" type="checkbox"/>	<input type="checkbox"/>	<input type="checkbox"/>	<input type="checkbox"/>
<input type="checkbox"/>	3	VLAN3	<input type="checkbox"/>	<input type="checkbox"/>	<input type="checkbox"/>	<input checked="" type="checkbox"/>	<input checked="" type="checkbox"/>	<input checked="" type="checkbox"/>	<input type="checkbox"/>	<input type="checkbox"/>	<input checked="" type="checkbox"/>	<input type="checkbox"/>	<input type="checkbox"/>	<input type="checkbox"/>

Figure 4-6-12: VLAN overlap port setting & VLAN 1 – The Public Area Member Assign

- Specify **Port-8** to be the 802.1Q VLAN **Trunk port**, and the Trunking port must be a **Tagged** port while egress. The Port-8 configuration is shown in the following screen in [Figure 4-6-13](#).

8	1	<input type="checkbox"/>	All	Tagged	Disable	802.1Q Tag
---	---	--------------------------	-----	--------	---------	------------

Figure 4-6-13: The configuration of VLAN Trunk Port

That is, although the VLAN 2 members: Port-1 to Port-3 and VLAN 3 members: Port-4 to Port-6 also belong to VLAN 1. But with different PVID settings, packets from VLAN 2 or VLAN 3 is not able to access to the other VLAN.

- Repeat Steps 1 to 5, set up the VLAN Trunk port at the partner switch and add more VLANs to join the VLAN trunk, repeat Steps 1 to 3 to assign the Trunk port to the VLANs.

4.6.10.3 Port Isolate

The diagram shows how the Managed Switch handles isolate and promiscuous ports, and the each PCs are not able to access each other PCs of each isolate port. But they all need to access with the same server/AP/Printer. The screen in [Figure 4-6-14](#) appears. This section will show you how to configure the port for the server – that could be accessed by each isolate port.

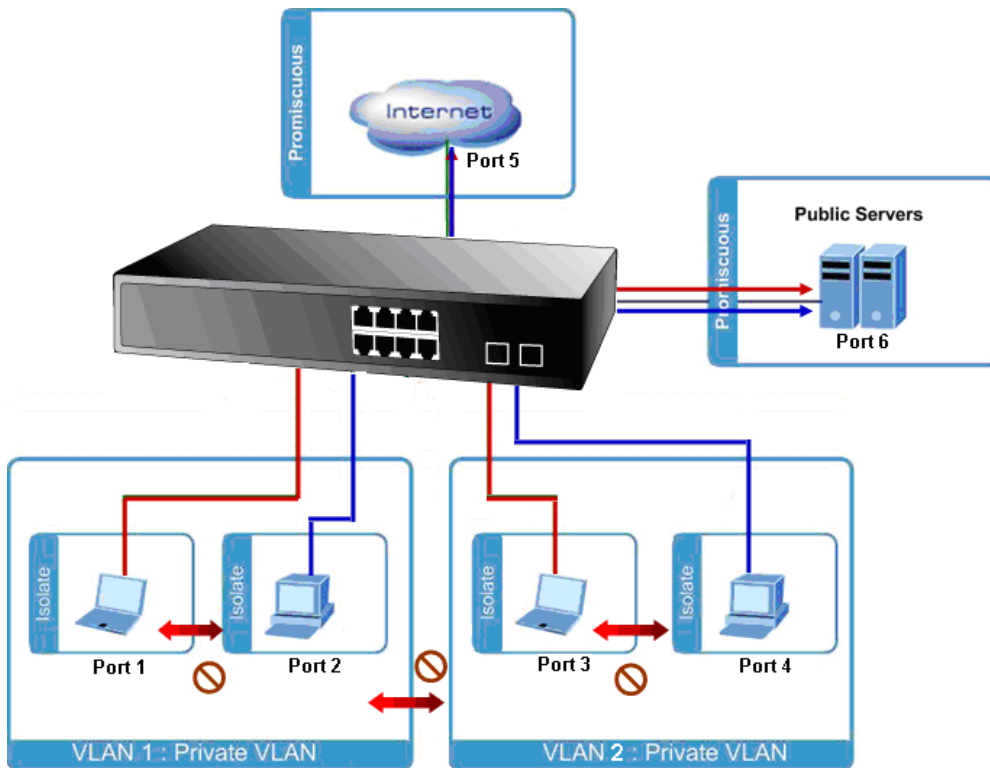

Figure 4-6-14: The Port Isolate VLAN Diagram

Setup steps

1. Assign Port Mode

Set Port-1~Port-4 in Isolate port.

Set Port5 and Port-6 in Promiscuous port. The screen in [Figure 4-6-15](#) appears.

Port Number									
1	2	3	4	5	6	7	8	9	10
<input checked="" type="checkbox"/>	<input checked="" type="checkbox"/>	<input checked="" type="checkbox"/>	<input checked="" type="checkbox"/>	<input type="checkbox"/>	<input type="checkbox"/>	<input type="checkbox"/>	<input type="checkbox"/>	<input type="checkbox"/>	<input type="checkbox"/>

Figure 4-6-15: The Configuration of Isolate and Promiscuous Port

2. Assign VLAN Member :

VLAN 1 : Port-1,Port-2 ,Port-5 and Port-3

VLAN 2 : Port-3~Port-6. The screen in [Figure 4-6-16](#) appears.

		Port Members									
Delete	PVLAN ID	1	2	3	4	5	6	7	8	9	10
<input type="checkbox"/>	1	<input checked="" type="checkbox"/>	<input checked="" type="checkbox"/>	<input type="checkbox"/>	<input type="checkbox"/>	<input checked="" type="checkbox"/>	<input checked="" type="checkbox"/>	<input checked="" type="checkbox"/>	<input checked="" type="checkbox"/>	<input checked="" type="checkbox"/>	<input checked="" type="checkbox"/>
<input type="checkbox"/>	2	<input type="checkbox"/>	<input type="checkbox"/>	<input checked="" type="checkbox"/>	<input checked="" type="checkbox"/>	<input checked="" type="checkbox"/>	<input checked="" type="checkbox"/>	<input type="checkbox"/>	<input type="checkbox"/>	<input type="checkbox"/>	<input type="checkbox"/>

Figure 4-6-16: Private VLAN Port Setting

4.6.11 MAC-based VLAN

The MAC-based VLAN entries can be configured here. This page allows for adding and deleting MAC-based VLAN entries and assigning the entries to different ports. This page shows only static entries. The MAC-based VLAN screen in [Figure 4-6-17](#) appears.

MAC-based VLAN Membership Configuration

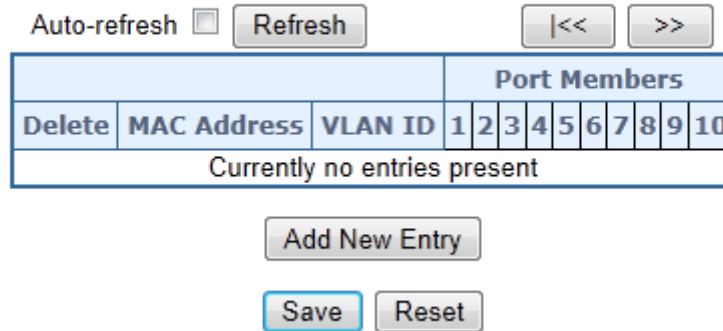

Figure 4-6-17: MAC-based VLAN Membership Configuration Page Screenshot

The page includes the following fields:

Object	Description
<ul style="list-style-type: none"> Delete 	To delete a MAC-based VLAN entry, check this box and press save. The entry will be deleted in the stack.
<ul style="list-style-type: none"> MAC Address 	Indicates the MAC address.
<ul style="list-style-type: none"> VLAN ID 	Indicates the VLAN ID.
<ul style="list-style-type: none"> Port Members 	A row of check boxes for each port is displayed for each MAC-based VLAN entry. To include a port in a MAC-based VLAN, check the box. To remove or exclude the port from the MAC-based VLAN, make sure the box is unchecked. By default, no ports are members, and all boxes are unchecked.

Buttons

Add new entry: Click to add a new MAC-based VLAN entry.

Save: Click to save changes.

Reset: Click to undo any changes made locally and revert to previously saved values.

Auto-refresh : Check this box to refresh the page automatically. Automatic refresh occurs every 3 seconds.

Refresh: Click to refresh the page immediately.

<<: Updates the table starting from the first entry in the MAC-based VLAN Table.

>>: Updates the table, starting with the entry after the last entry currently displayed.

4.6.12 MAC-based VLAN Status

This page shows MAC-based VLAN entries configured by various MAC-based VLAN users. The MAC-based VLAN Status screen in [Figure 4-6-18](#) appears.

MAC-based VLAN Membership Configuration for User Static

Static		Auto-refresh <input type="checkbox"/>		Refresh							
		Port Members									
MAC Address	VLAN ID	1	2	3	4	5	6	7	8	9	10
No data exists for the user											

Figure 4-6-18: MAC-based VLAN Membership Configuration for User Static Page Screenshot

The page includes the following fields:

Object	Description
• MAC Address	Indicates the MAC address.
• VLAN ID	Indicates the VLAN ID.
• Port Members	Port members of the MAC-based VLAN entry.

Buttons

Auto-refresh : Check this box to refresh the page automatically. Automatic refresh occurs every 3 seconds.

: Click to refresh the page immediately.

4.6.13 IP Subnet-based VLAN

This page allows for adding, updating and deleting IP subnet-based VLAN entries and assigning the entries to different ports.

The IP subnet-based VLAN screen in [Figure 4-6-19](#) appears.

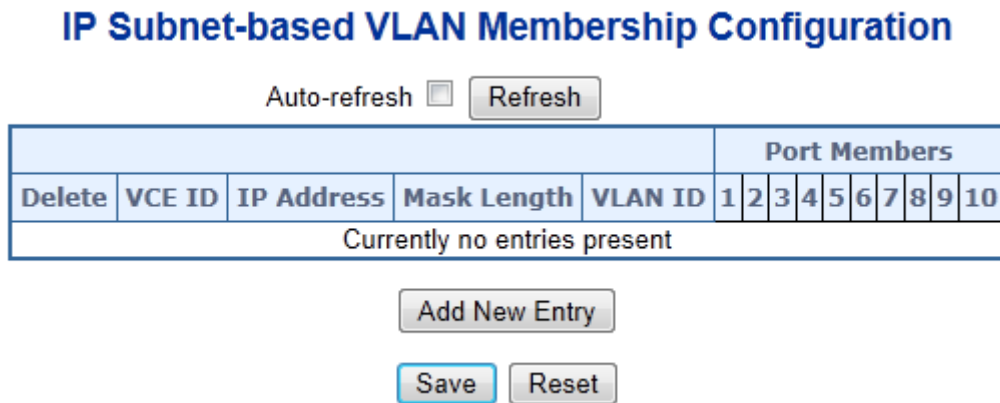

Figure 4-6-19: IP subnet-based VLAN Page Screenshot

The page includes the following fields:

Object	Description
• Delete	To delete an IP subnet-based VLAN entry, check this box and press save. The entry will be deleted in the stack.
• VEC ID	Indicates the index of the entry. It is user configurable. Its value ranges from 0-256. If a VCE ID is 0, application will auto-generate the VCE ID for that entry. Deletion and lookup of IP subnet-based VLAN are based on VCE ID.
• IP Address	Indicates the IP address.
• Mask Length	Indicates the network mask length.
• VLAN ID	Indicates the VLAN ID. VLAN ID can be changed for the existing entries.
• Port Members	A row of check boxes for each port is displayed for each IP subnet-based VLAN entry. To include a port in an IP subnet-based VLAN, check the box. To remove or exclude the port from the IP subnet-based VLAN, make sure the box is unchecked. By default, no ports are members, and all boxes are unchecked

Buttons

Add New Entry : Click to add a new IP subnet-based VLAN entry.

Save : Click to save changes.

Reset : Click to undo any changes made locally and revert to previously saved values.

Auto-refresh : Check this box to refresh the page automatically. Automatic refresh occurs every 3 seconds.

Refresh : Click to refresh the page immediately.

4.6.14 Protocol-based VLAN

This page allows you to add new protocols to Group Name (unique for each Group) mapping entries as well as allow you to see and delete already mapped entries for the switch. The Protocol-based VLAN screen in [Figure 4-6-20](#) appears.

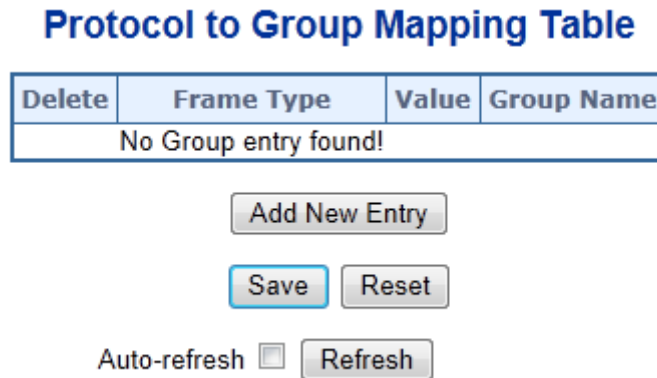

Figure 4-6-20: Protocol to Group Mapping Table Page Screenshot

The page includes the following fields:

Object	Description
<ul style="list-style-type: none"> Delete 	To delete a Protocol to Group Name map entry, check this box. The entry will be deleted on the switch during the next Save.
<ul style="list-style-type: none"> Frame Type 	<p>Frame Type can have one of the following values:</p> <ol style="list-style-type: none"> Ethernet LLC SNAP <p>Note: On changing the Frame type field, valid value of the following text field will vary depending on the new frame type you select.</p>
<ul style="list-style-type: none"> Value 	<p>Valid value that can be entered in this text field depends on the option selected from the the preceding Frame Type selection menu.</p> <p>Below is the criteria for three different Frame Types:</p> <ol style="list-style-type: none"> For Ethernet: Values in the text field when Ethernet is selected as a Frame Type is called etype. Valid values for etype ranges from 0x0600-0xffff For LLC: Valid value in this case is comprised of two different sub-values. <ol style="list-style-type: none"> DSAP: 1-byte long string (0x00-0xff) SSAP: 1-byte long string (0x00-0xff) For SNAP: Valid value in this case also is comprised of two different

	<p>sub-values.</p> <p>a. OUI: OUI (Organizationally Unique Identifier) is value in format of xx-xx-xx where each pair (xx) in string is a hexadecimal value ranges from 0x00-0xff.</p> <p>b. PID: If the OUI is hexadecimal 000000, the protocol ID is the Ethernet type (EtherType) field value for the protocol running on top of SNAP; if the OUI is an OUI for a particular organization, the protocol ID is a value assigned by that organization to the protocol running on top of SNAP. In other words, if value of OUI field is 00-00-00 then value of PID will be etype (0x0600-0xffff) and if value of OUI is other than 00-00-00 then valid value of PID will be any value from 0x0000 to 0xffff.</p>
<ul style="list-style-type: none"> • Group Name 	<p>A valid Group Name is a unique 16-character long string for every entry which consists of a combination of alphabets (a-z or A-Z) and integers(0-9). Note: special character and underscore(_) are not allowed.</p>

Buttons

Add New Entry

: Click to add a new entry in mapping table.

Save

: Click to save changes.

Reset

: Click to undo any changes made locally and revert to previously saved values.

Auto-refresh : Check this box to refresh the page automatically. Automatic refresh occurs every 3 seconds.

Refresh

: Click to refresh the page immediately.

4.6.15 Protocol-based VLAN Mambership

This page allows you to map an already configured Group Name to a VLAN for the switch. The Group Name to VLAN Mapping Table screen in [Figure 4-6-21](#) appears.

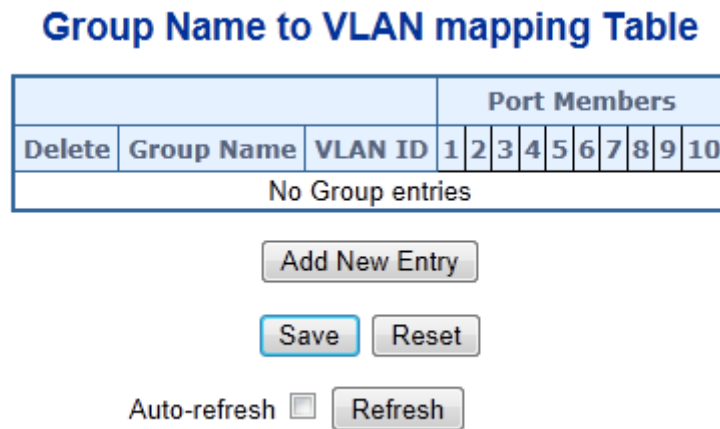

Figure 4-6-21: Group Name to VLAN Mapping Table Page Screenshot

The page includes the following fields:

Object	Description
<ul style="list-style-type: none"> Delete 	To delete a Group Name to VLAN map entry, check this box. The entry will be deleted on the switch during the next Save
<ul style="list-style-type: none"> Group Name 	A valid Group Name is a string of atmost 16 characters which consists of a combination of alphabets (a-z or A-Z) and integers(0-9), no special character is allowed. Whichever Group name you try mapping to a VLAN must be present in Protocol to Group mapping table and must not be preused by any other existing mapping entry on this page.
<ul style="list-style-type: none"> VLAN ID 	Indicates the ID to which Group Name will be mapped. A valid VLAN ID ranges from 1-4095.
<ul style="list-style-type: none"> Port Members 	A row of check boxes for each port is displayed for each Group Name to VLAN ID mapping. To include a port in a mapping, check the box. To remove or exclude the port from the mapping, make sure the box is unchecked. By default, no ports are members, and all boxes are unchecked.

Buttons

Add New Entry : Click to add a new entry in mapping table.

Save : Click to save changes.

Reset : Click to undo any changes made locally and revert to previously saved values.

Auto-refresh : Check this box to refresh the page automatically. Automatic refresh occurs every 3 seconds.

Refresh : Click to refresh the page immediately.

4.7 Spanning Tree Protocol

4.7.1 Theory

The Spanning Tree protocol can be used to detect and disable network loops, and to provide backup links between switches, bridges or routers. This allows the switch to interact with other bridging devices in your network to ensure that only one route exists between any two stations on the network, and provide backup links which automatically take over when a primary link goes down. The spanning tree algorithms supported by this switch include these versions:

- **STP – Spanning Tree Protocol (IEEE 802.1D)**
- **RSTP – Rapid Spanning Tree Protocol (IEEE 802.1w)**
- **MSTP – Multiple Spanning Tree Protocol (IEEE 802.1s)**

The **IEEE 802.1D Spanning Tree** Protocol and **IEEE 802.1w Rapid Spanning Tree** Protocol allow for the blocking of links between switches that form loops within the network. When multiple links between switches are detected, a primary link is established. Duplicated links are blocked from use and become standby links. The protocol allows for the duplicated links to be used in the event of a failure of the primary link. Once the Spanning Tree Protocol is configured and enabled, primary links are established and duplicated links are blocked automatically. The reactivation of the blocked links (at the time of a primary link failure) is also accomplished automatically without operator intervention.

This automatic network reconfiguration provides maximum uptime to network users. However, the concepts of the Spanning Tree Algorithm and protocol are a complicated and complex subject and must be fully researched and understood. It is possible to cause serious degradation of the performance of the network if the Spanning Tree is incorrectly configured. Please read the following before making any changes from the default values.

The Switch STP performs the following functions:

- Creates a single spanning tree from any combination of switching or bridging elements.
- Creates multiple spanning trees – from any combination of ports contained within a single switch, in user specified groups.
- Automatically reconfigures the spanning tree to compensate for the failure, addition, or removal of any element in the tree.
- Reconfigures the spanning tree without operator intervention.

Bridge Protocol Data Units

For STP to arrive at a stable network topology, the following information is used:

- The unique switch identifier
- The path cost to the root associated with each switch port
- The port identifier

STP communicates between switches on the network using Bridge Protocol Data Units (BPDUs). Each BPDU contains the following information:

- The unique identifier of the switch that the transmitting switch currently believes is the root switch
- The path cost to the root from the transmitting port

- The port identifier of the transmitting port

The switch sends BPDUs to communicate and construct the spanning-tree topology. All switches connected to the LAN on which the packet is transmitted will receive the BPDU. BPDUs are not directly forwarded by the switch, but the receiving switch uses the information in the frame to calculate a BPDU, and, if the topology changes, initiates a BPDU transmission.

The communication between switches via BPDUs results in the following:

- One switch is elected as the root switch
- The shortest distance to the root switch is calculated for each switch
- A designated switch is selected. This is the switch closest to the root switch through which packets will be forwarded to the root.
- A port for each switch is selected. This is the port providing the best path from the switch to the root switch.
- Ports included in the STP are selected.

Creating a Stable STP Topology

It is to make the root port a fastest link. If all switches have STP enabled with default settings, the switch with the lowest MAC address in the network will become the root switch. By increasing the priority (lowering the priority number) of the best switch, STP can be forced to select the best switch as the root switch.

When STP is enabled using the default parameters, the path between source and destination stations in a switched network might not be ideal. For instance, connecting higher-speed links to a port that has a higher number than the current root port can cause a root-port change.

STP Port States

The BPDUs take some time to pass through a network. This propagation delay can result in topology changes where a port that transitioned directly from a Blocking state to a Forwarding state could create temporary data loops. Ports must wait for new network topology information to propagate throughout the network before starting to forward packets. They must also wait for the packet lifetime to expire for BPDU packets that were forwarded based on the old topology. The forward delay timer is used to allow the network topology to stabilize after a topology change. In addition, STP specifies a series of states a port must transition through to further ensure that a stable network topology is created after a topology change.

Each port on a switch using STP exists in one of the following five states:

- **Blocking** – the port is blocked from forwarding or receiving packets
- **Listening** – the port is waiting to receive BPDU packets that may tell the port to go back to the blocking state
- **Learning** – the port is adding addresses to its forwarding database, but not yet forwarding packets
- **Forwarding** – the port is forwarding packets
- **Disabled** – the port only responds to network management messages and must return to the blocking state first

A port transitions from one state to another as follows:

- From initialization (switch boot) to blocking
- From blocking to listening or to disabled
- From listening to learning or to disabled
- From learning to forwarding or to disabled
- From forwarding to disabled
- From disabled to blocking

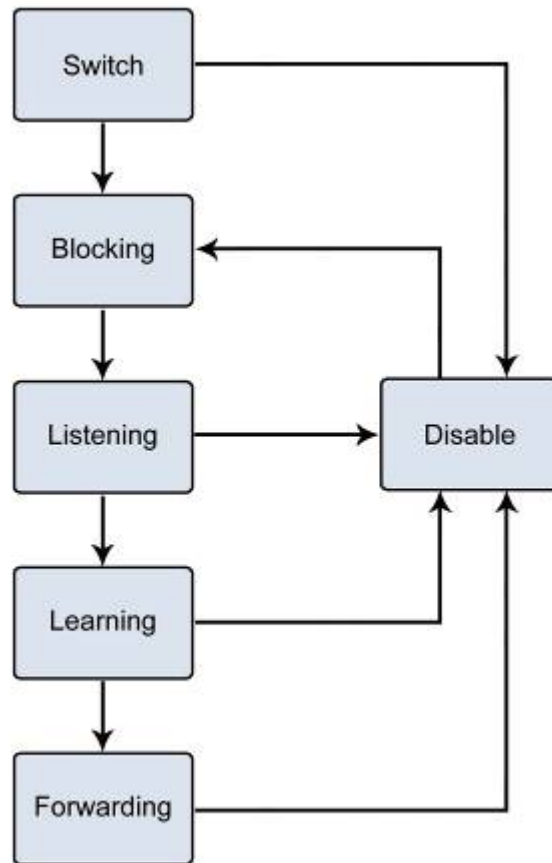



Figure 4-7-1: STP Port State Transitions

You can modify each port state by using management software. When you enable STP, every port on every switch in the network goes through the blocking state and then transitions through the states of listening and learning at power up. If properly configured, each port stabilizes to the forwarding or blocking state. No packets (except BPDUs) are forwarded from, or received by, STP enabled ports until the forwarding state is enabled for that port.

2. STP Parameters

STP Operation Levels

The Switch allows for two levels of operation: the switch level and the port level. The switch level forms a spanning tree consisting of links between one or more switches. The port level constructs a spanning tree consisting of groups of one or more ports. The STP operates in much the same way for both levels.

 Note	<p>On the switch level, STP calculates the Bridge Identifier for each switch and then sets the Root Bridge and the Designated Bridges.</p> <p>On the port level, STP sets the Root Port and the Designated Ports.</p>
--	---

The following are the user-configurable STP parameters for the switch level:

Parameter	Description	Default Value
Bridge Identifier(Not user configurable except by setting priority below)	A combination of the User-set priority and the switch's MAC address. The Bridge Identifier consists of two parts: a 16-bit priority and a 48-bit Ethernet MAC address 32768 + MAC	32768 + MAC
Priority	A relative priority for each switch – lower numbers give a higher priority and a greater chance of a given switch being elected as the root bridge	32768
Hello Time	The length of time between broadcasts of the hello message by the switch	2 seconds
Maximum Age Timer	Measures the age of a received BPDU for a port and ensures that the BPDU is discarded when its age exceeds the value of the maximum age timer.	20 seconds
Forward Delay Timer	The amount time spent by a port in the learning and listening states waiting for a BPDU that may return the port to the blocking state.	15 seconds

The following are the user-configurable STP parameters for the port or port group level:

Variable	Description	Default Value
Port Priority	A relative priority for each port –lower numbers give a higher priority and a greater chance of a given port being elected as the root port	128
Port Cost	A value used by STP to evaluate paths – STP calculates path costs and selects the path with the minimum cost as the active path	200,000-100Mbps Fast Ethernet ports 20,000-100Mbps Gigabit Ethernet ports 0 - Auto

Default Spanning-Tree Configuration

Feature	Default Value
Enable state	STP disabled for all ports
Port priority	128
Port cost	0
Bridge Priority	32,768

User-Changeable STA Parameters

The switch's factory default setting should cover the majority of installations. However, it is advisable to keep the default settings as set at the factory; unless, it is absolutely necessary. The user changeable parameters in the Switch are as follows:

Priority – A Priority for the switch can be set from 0 to 65535. 0 is equal to the highest Priority.

Hello Time – The Hello Time can be from 1 to 10 seconds. This is the interval between two transmissions of BPDU packets sent by the Root Bridge to tell all other Switches that it is indeed the Root Bridge. If you set a Hello Time for your Switch, and it is not the Root Bridge, the set Hello Time will be used if and when your Switch becomes the Root Bridge.

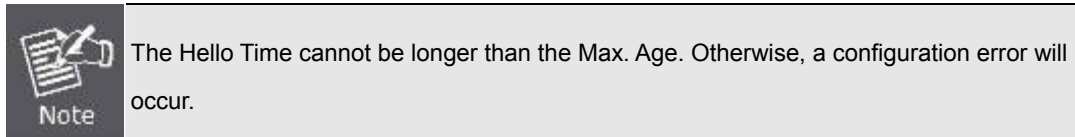

Max. Age – The Max Age can be from 6 to 40 seconds. At the end of the Max. Age, if a BPDU has still not been received from the Root Bridge, your Switch will start sending its own BPDU to all other Switches for permission to become the Root Bridge. If it turns out that your Switch has the lowest Bridge Identifier, it will become the Root Bridge.

Forward Delay Timer – The Forward Delay can be from 4 to 30 seconds. This is the time any port on the Switch spends in the listening state while moving from the blocking state to the forwarding state.

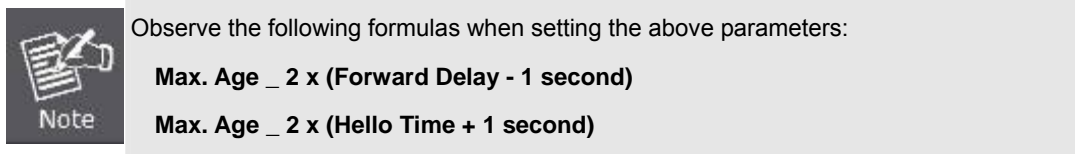

Port Priority – A Port Priority can be from 0 to 240. The lower the number, the greater the probability the port will be chosen as the Root Port.

Port Cost – A Port Cost can be set from 0 to 200000000. The lower the number, the greater the probability the port will be chosen to forward packets.

3. Illustration of STP

A simple illustration of three switches connected in a loop is depicted in the below diagram. In this example, you can anticipate some major network problems if the STP assistance is not applied.

If switch A broadcasts a packet to switch B, switch B will broadcast it to switch C, and switch C will broadcast it to back to switch A and so on. The broadcast packet will be passed indefinitely in a loop, potentially causing a network failure. In this example, STP breaks the loop by blocking the connection between switch B and C. The decision to block a particular connection is based on the STP calculation of the most current Bridge and Port settings.

Now, if switch A broadcasts a packet to switch C, then switch C will drop the packet at port 2 and the broadcast will end there. Setting-up STP using values other than the defaults, can be complex. Therefore, you are advised to keep the default factory settings and STP will automatically assign root bridges/ports and block loop connections. Influencing STP to choose a particular switch as the root bridge using the Priority setting, or influencing STP to choose a particular port to block using the Port Priority and Port Cost settings is, however, relatively straight forward.

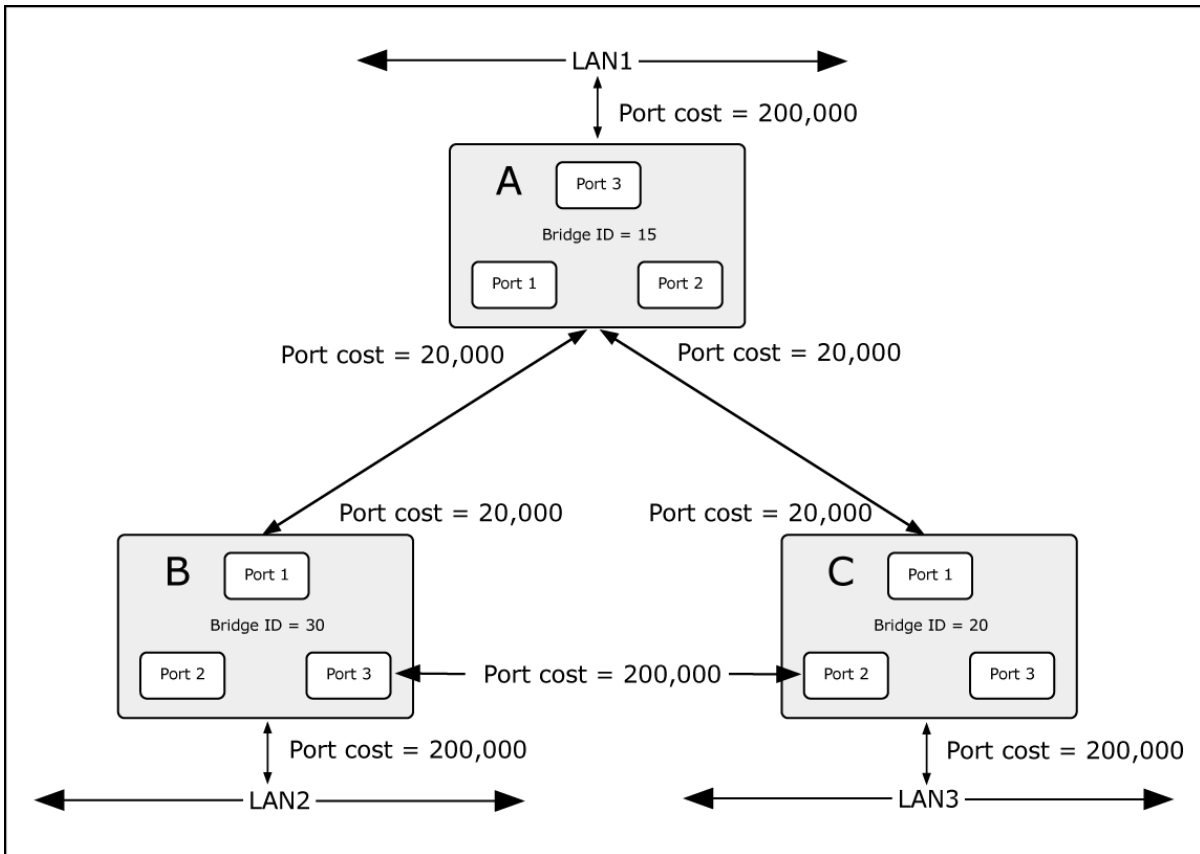

Figure 4-7-2: Before Applying the STA Rules

For this example, only the default STP values are used.

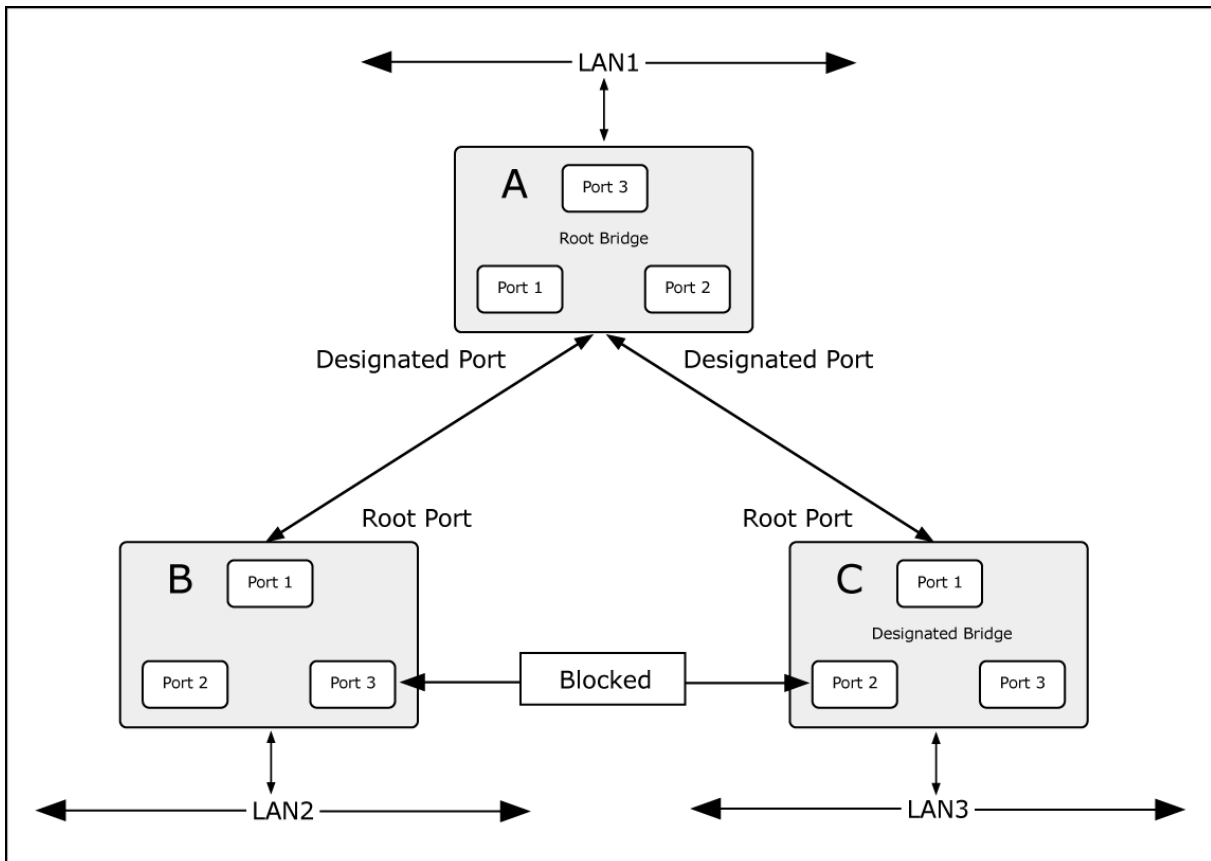

Figure 4-7-3: After Applying the STA Rules

The switch with the lowest Bridge ID (switch C) was elected the root bridge, and the ports were selected to give a high port cost between switches B and C. The two (optional) Gigabit ports (default port cost = 20,000) on switch A are connected to one (optional) Gigabit port on both switch B and C. The redundant link between switch B and C is deliberately chosen as a 100 Mbps Fast Ethernet link (default port cost = 200,000). Gigabit ports could be used, but the port cost should be increased from the default to ensure that the link between switch B and switch C is the blocked link.

4.7.2 STP System Configuration

This page allows you to configure STP system settings. The settings are used by all STP Bridge instances in the Switch or switch Stack. The Managed Switch support the following Spanning Tree protocols:

- **Compatible -- Spanning Tree Protocol (STP):** Provides a single path between end stations, avoiding and eliminating loops.
- **Normal -- Rapid Spanning Tree Protocol (RSTP) :** Detects and uses of network topologies that provide faster spanning tree convergence, without creating forwarding loops.
- **Extension – Multiple Spanning Tree Protocol (MSTP) :** Defines an extension to RSTP to further develop the usefulness of virtual LANs (VLANs). This "Per-VLAN" Multiple Spanning Tree Protocol configures a separate Spanning Tree for each VLAN group and blocks all but one of the possible alternate paths within each Spanning Tree.

The STP System Configuration screen in [Figure 4-7-4](#) appears.

The screenshot shows the 'STP Bridge Configuration' page with two sections: 'Basic Settings' and 'Advanced Settings'. Below are the details for each section.

Basic Settings	
Protocol Version	MSTP
Bridge Priority	128
Forward Delay	15
Max Age	20
Maximum Hop Count	20
Transmit Hold Count	6

Advanced Settings	
Edge Port BPDU Filtering	<input type="checkbox"/>
Edge Port BPDU Guard	<input type="checkbox"/>
Port Error Recovery	<input type="checkbox"/>
Port Error Recovery Timeout	<input type="text"/>

At the bottom of the configuration area are two buttons: 'Save' and 'Reset'.

Figure 4-7-4: STP Bridge Configuration Page Screenshot

The page includes the following fields:

Basic Settings

Object	Description
<ul style="list-style-type: none"> • Protocol Version 	The STP protocol version setting. Valid values are STP , RSTP and MSTP .
<ul style="list-style-type: none"> • Bridge Priority 	Controls the bridge priority. Lower numeric values have better priority. The bridge priority plus the MSTI instance number, concatenated with the 6-byte MAC address of the switch forms a Bridge Identifier. For MSTP operation, this is the priority of the CIST. Otherwise, this is the priority of the STP/RSTP bridge.
<ul style="list-style-type: none"> • Forward Delay 	The delay used by STP Bridges to transition Root and Designated Ports to Forwarding (used in STP compatible mode). Valid values are in the range 4 to 30 seconds -Default: 15 -Minimum: The higher of 4 or [(Max. Message Age / 2) + 1] -Maximum: 30
<ul style="list-style-type: none"> • Max Age 	The maximum age of the information transmitted by the Bridge when it is the Root Bridge. Valid values are in the range 6 to 40 seconds. -Default: 20 -Minimum: The higher of 6 or [2 x (Hello Time + 1)]. -Maximum: The lower of 40 or [2 x (Forward Delay - 1)]
<ul style="list-style-type: none"> • Maximum Hop Count 	This defines the initial value of remaining Hops for MSTI information generated at the boundary of an MSTI region. It defines how many bridges a root bridge can distribute its BPDU information. Valid values are in the range 6 to 40 hops.
<ul style="list-style-type: none"> • Transmit Hold Count 	The number of BPDU's a bridge port can send per second. When exceeded, transmission of the next BPDU will be delayed. Valid values are in the range 1 to 10 BPDU's per second.

Advanced Settings

Object	Description
<ul style="list-style-type: none"> • Edge Port BPDU Filtering 	Control whether a port explicitly configured as Edge will transmit and receive BPDUs.
<ul style="list-style-type: none"> • Edge Port BPDU Guard 	Control whether a port explicitly configured as Edge will disable itself upon reception of a BPDU. The port will enter the error-disabled state, and will be removed from the active topology.
<ul style="list-style-type: none"> • Port Error Recovery 	Control whether a port in the error-disabled state automatically will be enabled after a certain time. If recovery is not enabled, ports have to be disabled and

	re-enabled for normal STP operation. The condition is also cleared by a system reboot.
<ul style="list-style-type: none"> • Port Error Recovery Timeout 	The time that has to pass before a port in the <i>error-disabled</i> state can be enabled. Valid values are between 30 and 86400 seconds (24 hours).



The **Industrial Managed Switch** implements the Rapid Spanning Protocol as the default spanning tree protocol. While selecting “**Compatible**” mode, the system uses the RSTP (802.1w) to compatible and co work with another STP (802.1D)’s BPDU control packet.

Buttons



: Click to save changes.



: Click to undo any changes made locally and revert to previously saved values.

4.7.3 Bridge Status

This page provides a status overview for all STP bridge instances.

The displayed table contains a row for each STP bridge instance, where the column displays the following information: The Bridge Status screen in [Figure 4-7-5](#) appears.

STP Bridges						
MSTI	Bridge ID	Root			Topology Flag	Topology Change Last
		ID	Port	Cost		
CIST	80:00-00:30:4F:10:02:00	80:00-00:30:4F:10:02:00	-	0	Steady	-

Auto-refresh

Figure 4-7-5: STP Bridge Status Page Screenshot

The page includes the following fields:

Object	Description
• MSTI	The Bridge Instance. This is also a link to the STP Detailed Bridge Status.
• Bridge ID	The Bridge ID of this Bridge instance.
• Root ID	The Bridge ID of the currently elected root bridge.
• Root Port	The switch port currently assigned the <i>root</i> port role.
• Root Cost	Root Path Cost. For the Root Bridge this is zero. For all other Bridges, it is the sum of the Port Path Costs on the least cost path to the Root Bridge.
• Topology Flag	The current state of the Topology Change Flag for this Bridge instance.
• Topology Change Last	The time since last Topology Change occurred.

4.7.4 CIST Port Configuration

This page allows the user to inspect the current STP CIST port configurations, and possibly change them as well. The CIST Port Configuration screen in Figure 4-7-6 appears.

STP CIST Port Configuration

CIST Aggregated Port Configuration

Port	STP Enabled	Path Cost		Priority	Admin Edge	Auto Edge	Restricted		BPDU Guard	Point-to-point
							Role	TCN		
-	<input type="checkbox"/>	Auto		128	Non-Edge	<input checked="" type="checkbox"/>	<input type="checkbox"/>	<input type="checkbox"/>	<input type="checkbox"/>	Forced True

CIST Normal Port Configuration

Port	STP Enabled	Path Cost		Priority	Admin Edge	Auto Edge	Restricted		BPDU Guard	Point-to-point
							Role	TCN		
*	<input type="checkbox"/>	<All>		<All>	<All>	<input type="checkbox"/>	<input type="checkbox"/>	<input type="checkbox"/>	<input type="checkbox"/>	<All>
1	<input type="checkbox"/>	Auto		128	Non-Edge	<input checked="" type="checkbox"/>	<input type="checkbox"/>	<input type="checkbox"/>	<input type="checkbox"/>	Auto
2	<input type="checkbox"/>	Auto		128	Non-Edge	<input checked="" type="checkbox"/>	<input type="checkbox"/>	<input type="checkbox"/>	<input type="checkbox"/>	Auto
3	<input type="checkbox"/>	Auto		128	Non-Edge	<input checked="" type="checkbox"/>	<input type="checkbox"/>	<input type="checkbox"/>	<input type="checkbox"/>	Auto
4	<input type="checkbox"/>	Auto		128	Non-Edge	<input checked="" type="checkbox"/>	<input type="checkbox"/>	<input type="checkbox"/>	<input type="checkbox"/>	Auto
5	<input type="checkbox"/>	Auto		128	Non-Edge	<input checked="" type="checkbox"/>	<input type="checkbox"/>	<input type="checkbox"/>	<input type="checkbox"/>	Auto
6	<input type="checkbox"/>	Auto		128	Non-Edge	<input checked="" type="checkbox"/>	<input type="checkbox"/>	<input type="checkbox"/>	<input type="checkbox"/>	Auto
7	<input type="checkbox"/>	Auto		128	Non-Edge	<input checked="" type="checkbox"/>	<input type="checkbox"/>	<input type="checkbox"/>	<input type="checkbox"/>	Auto
8	<input type="checkbox"/>	Auto		128	Non-Edge	<input checked="" type="checkbox"/>	<input type="checkbox"/>	<input type="checkbox"/>	<input type="checkbox"/>	Auto
9	<input type="checkbox"/>	Auto		128	Non-Edge	<input checked="" type="checkbox"/>	<input type="checkbox"/>	<input type="checkbox"/>	<input type="checkbox"/>	Auto
10	<input type="checkbox"/>	Auto		128	Non-Edge	<input checked="" type="checkbox"/>	<input type="checkbox"/>	<input type="checkbox"/>	<input type="checkbox"/>	Auto

Figure 4-7-6 : STP CIST Port Configuration Page Screenshot

The page includes the following fields:

Object	Description
<ul style="list-style-type: none"> • Port 	The switch port number of the logical STP port.
<ul style="list-style-type: none"> • STP Enabled 	Controls whether RSTP is enabled on this switch port, * means to select all ports of Industrial Managed Switch.
<ul style="list-style-type: none"> • Path Cost 	Controls the path cost incurred by the port. The Auto setting will set the path cost as appropriate by the physical link speed, using the 802.1D recommended values. Using the Specific setting, a user-defined value can be entered. The path cost is used when establishing the active topology of the network. Lower path cost ports are chosen as forwarding ports in favor of higher path cost ports. Valid values are in the range 1 to 200000000. All means all ports will have one specific setting.
<ul style="list-style-type: none"> • Priority 	Controls the port priority. This can be used to control priority of ports having identical port cost. (See above). Default: 128

	<p>Range: 0-240, in steps of 16</p> <p>All means all ports will have one specific setting.</p>
<ul style="list-style-type: none"> • operEdge (state flag) 	<p>Operational flag describing whether the port is connecting directly to edge devices. (No Bridges attached). Transition to the forwarding state is faster for edge ports (having <i>operEdge</i> true) than for other ports. The value of this flag is based on AdminEdge and AutoEdge fields. This flag is displayed as Edge in Monitor->Spanning Tree -> STP Detailed Bridge Status.</p>
<ul style="list-style-type: none"> • Admin Edge 	<p>Controls whether the operEdge flag should start as being set or cleared. (The initial operEdge state when a port is initialized). All means all ports will have one specific setting.</p>
<ul style="list-style-type: none"> • Auto Edge 	<p>Controls whether the bridge should enable automatic edge detection on the bridge port. This allows operEdge to be derived from whether BPDU's are received on the port or not.</p>
<ul style="list-style-type: none"> • Restricted Role 	<p>If enabled, causes the port not to be selected as Root Port for the CIST or any MSTI, even if it has the best spanning tree priority vector. Such a port will be selected as an Alternate Port after the Root Port has been selected. If set, it can cause lack of spanning tree connectivity. It can be set by a network administrator to prevent bridges external to a core region of the network influence the spanning tree active topology, possibly because those bridges are not under the full control of the administrator. This feature is also known as Root Guard.</p>
<ul style="list-style-type: none"> • Restricted TCN 	<p>If enabled, causes the port not to propagate received topology change notifications and topology changes to other ports. If set it can cause temporary loss of connectivity after changes in a spanning tree's active topology as a result of persistently incorrect learned station location information. It is set by a network administrator to prevent bridges external to a core region of the network, causing address flushing in that region, possibly because those bridges are not under the full control of the administrator or the physical link state of the attached LANs transits frequently.</p>
<ul style="list-style-type: none"> • BPDU Guard 	<p>If enabled, causes the port to disable itself upon receiving valid BPDU's. Contrary to the similar bridge setting, the port Edge status does not effect this setting. A port entering error-disabled state due to this setting is subject to the bridge Port Error Recovery setting as well.</p>
<ul style="list-style-type: none"> • Point-to-Point 	<p>Controls whether the port connects to a point-to-point LAN rather than a shared medium. This can be automatically determined, or forced either true or false. A transition to the forwarding state is faster for point-to-point LANs than for shared media. All means all ports will have one specific setting.</p>

Buttons

Save: Click to save changes.

Reset: Click to undo any changes made locally and revert to previously saved values.

By default, the system automatically detects the speed and duplex mode used on each port, and configures the path cost according to the values shown below. Path cost "0" is used to indicate auto-configuration mode. When the short path cost method is selected and the default path cost recommended by the IEEE 802.1w standard exceeds 65,535, the default is set to 65,535.

Port Type	IEEE 802.1D-1998	IEEE 802.1w-2001
Ethernet	50-600	200,000-20,000,000
Fast Ethernet	10-60	20,000-2,000,000
Gigabit Ethernet	3-10	2,000-200,000

Table 4-7-1: Recommended STP Path Cost Range

Port Type	Link Type	IEEE 802.1D-1998	IEEE 802.1w-2001
Ethernet	Half Duplex	100	2,000,000
	Full Duplex	95	1,999,999
	Trunk	90	1,000,000
Fast Ethernet	Half Duplex	19	200,000
	Full Duplex	18	100,000
	Trunk	15	50,000
Gigabit Ethernet	Full Duplex	4	10,000
	Trunk	3	5,000

Table 4-7-2: Recommended STP Path Costs

Port Type	Link Type	IEEE 802.1w-2001
Ethernet	Half Duplex	2,000,000
	Full Duplex	1,000,000
	Trunk	500,000
Fast Ethernet	Half Duplex	200,000
	Full Duplex	100,000
	Trunk	50,000
Gigabit Ethernet	Full Duplex	10,000
	Trunk	5,000

Table 4-7-3: Default STP Path Costs

4.7.5 MSTI Priorities

This page allows the user to inspect the current STP MSTI bridge instance priority configurations, and possibly change them as well. The MSTI Priority screen in [Figure 4-7-7](#) appears.

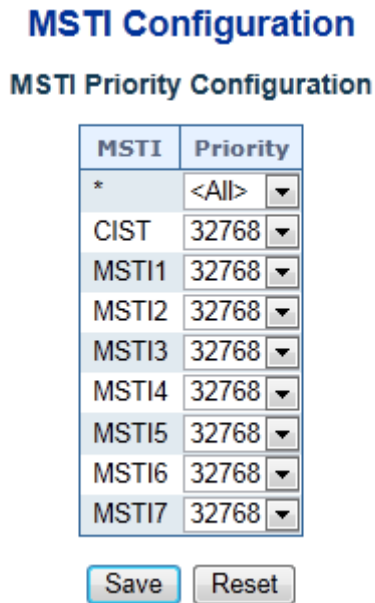

Figure 4-7-7: MSTI Priority Page Screenshot

The page includes the following fields:

Object	Description
<ul style="list-style-type: none"> MSTI 	The bridge instance. The CIST is the default instance, which is always active.
<ul style="list-style-type: none"> Priority 	<p>The Configuration All with available values will assign to whole items.</p> <p>Controls the bridge priority. Lower numerical values have better priority.</p> <p>The bridge priority plus the MSTI instance number, concatenated with the 6-byte MAC address of the switch forms a Bridge Identifier, * means all MSTI items will have one priority setting.</p>

Buttons

: Click to save changes.

: Click to undo any changes made locally and revert to previously saved values.

4.7.6 MSTI Configuration

This page allows the user to inspect the current STP MSTI bridge instance priority configurations, and possibly change them as well. The MSTI Configuration screen in [Figure 4-7-8](#) appears.

MSTI Configuration

Add VLANs separated by spaces or comma.

Unmapped VLANs are mapped to the CIST. (The default bridge instance).

Configuration Identification

Configuration Name	00-30-4f-10-02-00
Configuration Revision	0

MSTI Mapping

MSTI	VLANs Mapped
MSTI1	
MSTI2	
MSTI3	
MSTI4	
MSTI5	
MSTI6	
MSTI7	

Figure 4-7-8: MSTI Configuration Page Screenshot

The page includes the following fields:

Configuration Identification

Object	Description
<ul style="list-style-type: none"> Configuration Name 	The name identifying the VLAN to MSTI mapping. Bridges must share the name and revision (see below), as well as the VLAN-to-MSTI mapping configuration in order to share spanning trees for MSTI's. (Intra-region). The name is at most 32 characters.
<ul style="list-style-type: none"> Configuration Revision 	The revision of the MSTI configuration named above. This must be an integer between 0 and 65535.

MSTI Mapping

Object	Description
<ul style="list-style-type: none"> MSTI 	The bridge instance. The CIST is not available for explicit mapping, as it will receive the VLANs not explicitly mapped.
<ul style="list-style-type: none"> VLANs Mapped 	The list of VLAN's mapped to the MSTI. The VLANs must be separated with comma and/or space. A VLAN can only be mapped to <i>one</i> MSTI. A unused MSTI should just be left empty. (I.e. not having any VLANs mapped to it.)

Buttons

: Click to save changes.

: Click to undo any changes made locally and revert to previously saved values.

4.7.7 MSTI Ports Configuration

This page allows the user to inspect the current STP MSTI port configurations, and possibly change them as well.

A MSTI port is a virtual port, which is instantiated separately for each active CIST (physical) port for each MSTI instance configured and applicable for the port. The MSTI instance must be selected before displaying actual MSTI port configuration options.

This page contains MSTI port settings for physical and aggregated ports. The aggregation settings are stack global. The MSTI Port Configuration screen in [Figure 4-7-9](#) & [Figure 4-7-10](#) appears.



Figure 4-7-9: MSTI Port Configuration Page Screenshot

The page includes the following fields:

MSTI Port Configuration

Object	Description
<ul style="list-style-type: none"> • Select MSTI 	Select the bridge instance and set more detail configuration.

MST1 MSTI Port Configuration

MSTI Aggregated Ports Configuration

Port	Path Cost	Priority
-	Auto <input type="text"/>	128 <input type="text"/>

MSTI Normal Ports Configuration

Port	Path Cost	Priority
*	<All> <input type="text"/>	<All> <input type="text"/>
1	Auto <input type="text"/>	128 <input type="text"/>
2	Auto <input type="text"/>	128 <input type="text"/>
3	Auto <input type="text"/>	128 <input type="text"/>
4	Auto <input type="text"/>	128 <input type="text"/>
5	Auto <input type="text"/>	128 <input type="text"/>
6	Auto <input type="text"/>	128 <input type="text"/>
7	Auto <input type="text"/>	128 <input type="text"/>
8	Auto <input type="text"/>	128 <input type="text"/>
9	Auto <input type="text"/>	128 <input type="text"/>
10	Auto <input type="text"/>	128 <input type="text"/>

Save Reset

Figure 4-7-10: MST1 MSTI Port Configuration Page Screenshot

The page includes the following fields:

MSTx MSTI Port Configuration

Object	Description
<ul style="list-style-type: none"> Port 	The switch port number of the corresponding STP CIST (and MSTI) port.
<ul style="list-style-type: none"> Path Cost 	The Configuration All with available values will assign to whole items. Controls the path cost incurred by the port. The Auto setting will set the path cost as appropriate by the physical link speed, using the 802.1D recommended values. Using the Specific setting, a user-defined value can be entered. The path cost is used when establishing the active topology of the network. Lower path cost ports are chosen as forwarding ports in favor of higher path cost ports. Valid values are in the range 1 to 200000000. All means all ports will have one specific setting.
<ul style="list-style-type: none"> Priority 	The Configuration All with available values will assign to whole items. Controls the port priority. This can be used to control priority of ports having identical port cost. (See above). All means all ports will have one specific setting.

Buttons

Get: Click to set MSTx configuration

Save: Click to save changes.

Reset: Click to undo any changes made locally and revert to previously saved values.

4.7.8 Port Status

This page displays the STP CIST port status for port physical ports in the currently selected switch.

The STP Port Status screen in [Figure 4-7-11](#) appears.

STP Port Status

Port	CIST Role	CIST State	Uptime
1	Non-STP	Forwarding	-
2	Non-STP	Forwarding	-
3	Non-STP	Forwarding	-
4	Non-STP	Forwarding	-
5	Non-STP	Forwarding	-
6	Non-STP	Forwarding	-
7	Non-STP	Forwarding	-
8	Non-STP	Forwarding	-
9	Non-STP	Forwarding	-
10	Non-STP	Forwarding	-

Auto-refresh **Refresh**

Figure 4-7-11: STP Port Status Page Screenshot

The page includes the following fields:

Object	Description
<ul style="list-style-type: none"> • Port 	The switch port number of the logical STP port.
<ul style="list-style-type: none"> • CIST Role 	The current STP port role of the ICST port. The port role can be one of the following values: <ul style="list-style-type: none"> ■ AlternatePort ■ BackupPort ■ RootPort ■ DesignatedPort
<ul style="list-style-type: none"> • CIST State 	The current STP port state of the CIST port . The port state can be one of the following values: <ul style="list-style-type: none"> ■ Disabled ■ Blocking ■ Learning

	<ul style="list-style-type: none"> ■ Forwarding ■ Non-STP
• Uptime	The time since the bridge port was last initialized.

Buttons

Auto-refresh : Check this box to refresh the page automatically. Automatic refresh occurs every 3 seconds.

: Click to refresh the page immediately.

4.7.9 Port Statistics

This page displays the STP port statistics counters for port physical ports in the currently selected switch.

The STP Port Statistics screen in [Figure 4-7-12](#) appears.

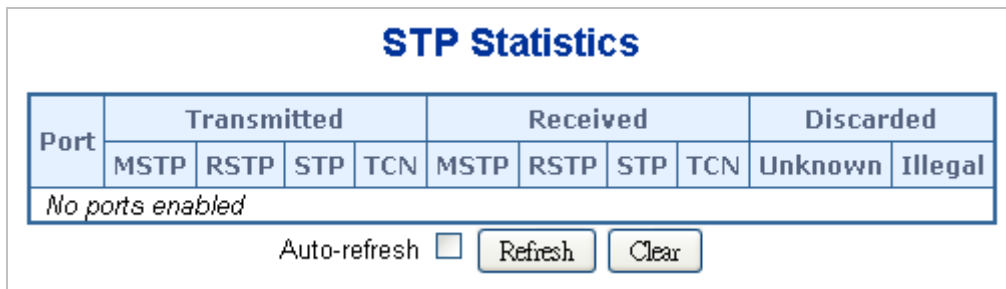

Figure 4-7-12: STP Statistics Page Screenshot

The page includes the following fields:

Object	Description
• Port	The switch port number of the logical RSTP port.
• MSTP	The number of MSTP Configuration BPDU's received/transmitted on the port.
• RSTP	The number of RSTP Configuration BPDU's received/transmitted on the port.
• STP	The number of legacy STP Configuration BPDU's received/transmitted on the port.
• TCN	The number of (legacy) Topology Change Notification BPDU's received/transmitted on the port.
• Discarded Unknown	The number of unknown Spanning Tree BPDU's received (and discarded) on the port.
• Discarded Illegal	The number of illegal Spanning Tree BPDU's received (and discarded) on the port.

4.8 Multicast

4.8.1 IGMP Snooping

The **Internet Group Management Protocol (IGMP)** lets host and routers share information about multicast group memberships. IGMP snooping is a switch feature that monitors the exchange of IGMP messages and copies them to the CPU for feature processing. The overall purpose of IGMP Snooping is to limit the forwarding of multicast frames to only ports that are a member of the multicast group.

About the Internet Group Management Protocol (IGMP) Snooping

Computers and network devices that want to receive multicast transmissions need to inform nearby routers that they will become members of a multicast group. The **Internet Group Management Protocol (IGMP)** is used to communicate this information. IGMP is also used to periodically check the multicast group for members that are no longer active. In the case where there is more than one multicast router on a sub network, one router is elected as the 'queried'. This router then keeps track of the membership of the multicast groups that have active members. The information received from IGMP is then used to determine if multicast packets should be forwarded to a given sub network or not. The router can check, using IGMP, to see if there is at least one member of a multicast group on a given subnet work. If there are no members on a sub network, packets will not be forwarded to that sub network.

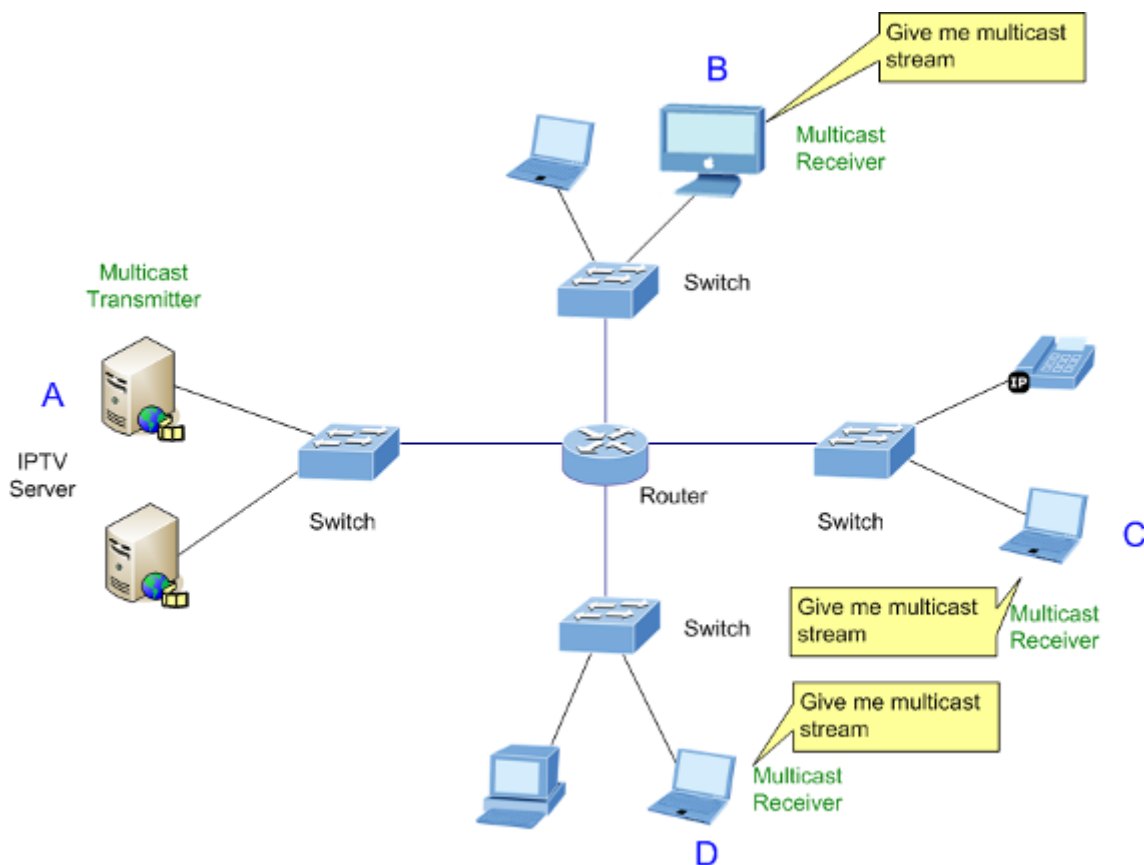

Figure 4-8-1: Multicast Service

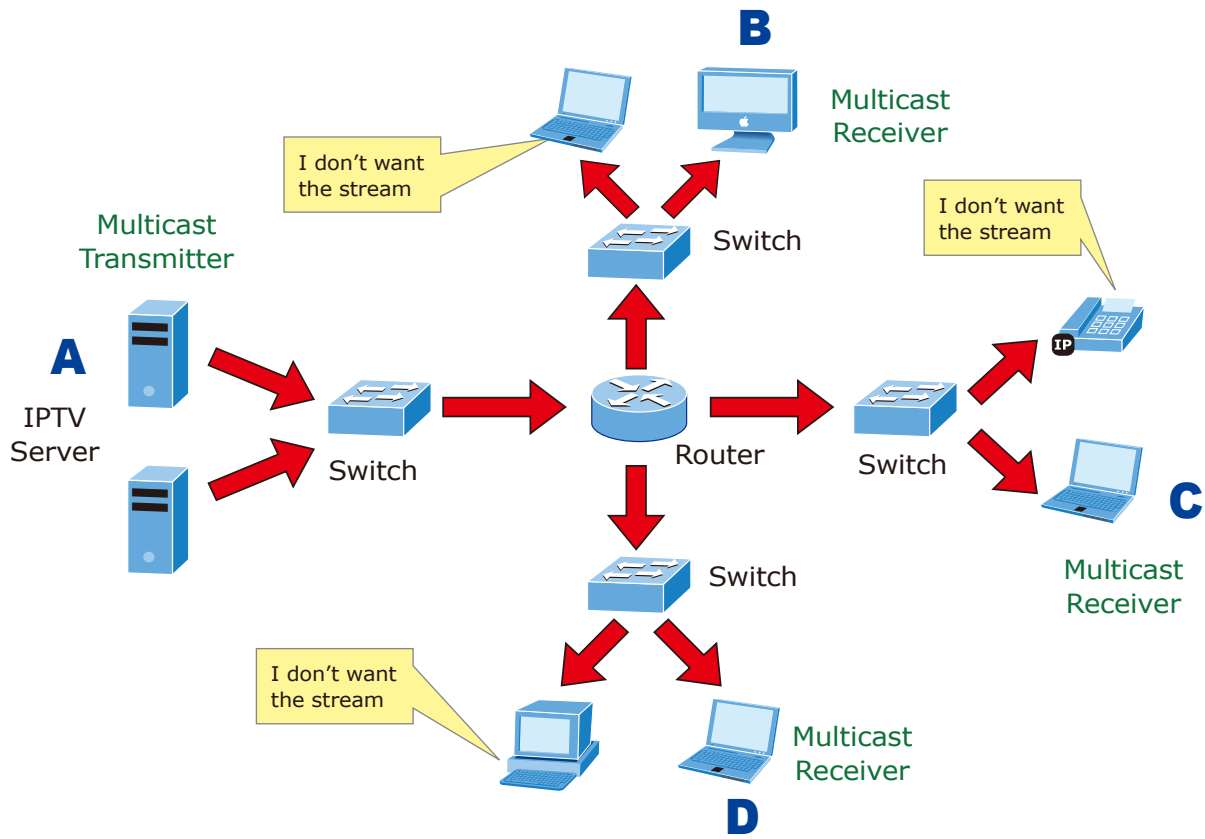

Figure 4-8-2: Multicast Flooding

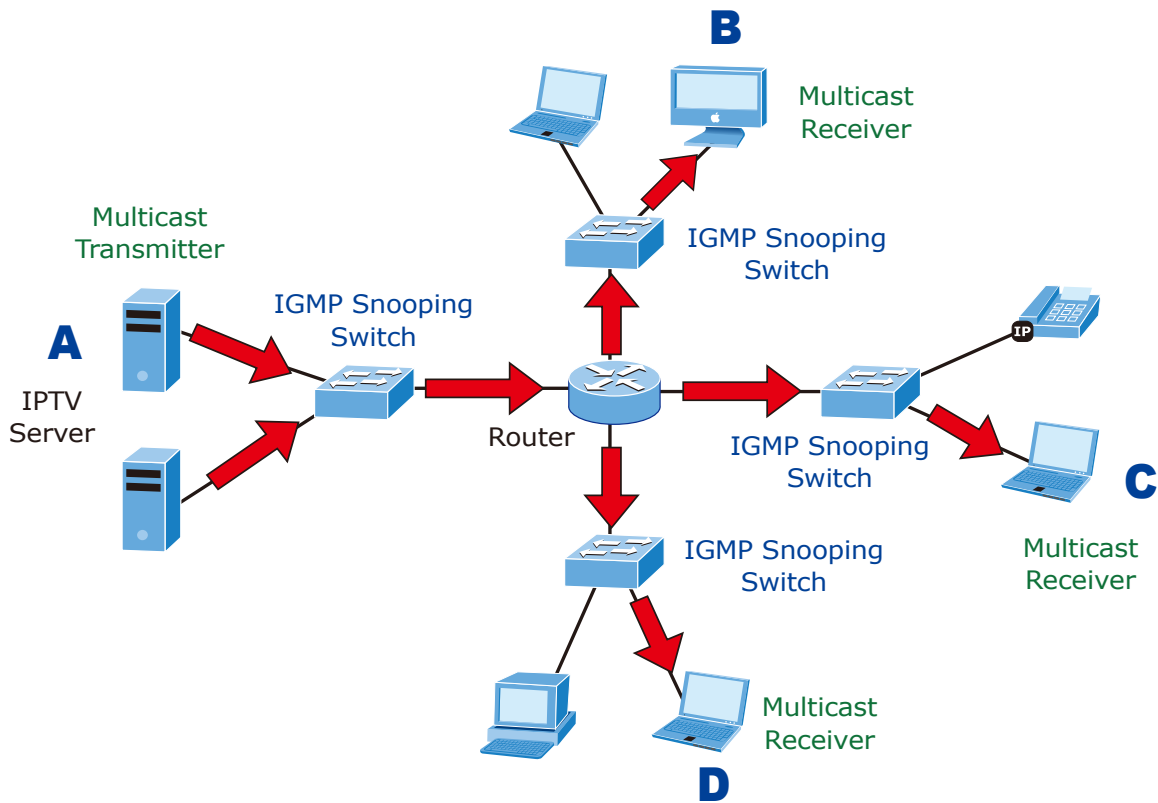

Figure 4-8-3: IGMP Snooping Multicast Stream Control

IGMP Versions 1 and 2

Multicast groups allow members to join or leave at any time. IGMP provides the method for members and multicast routers to communicate when joining or leaving a multicast group.

IGMP version 1 is defined in RFC 1112. It has a fixed packet size and no optional data.

The format of an IGMP packet is shown below:

IGMP Message Format

Octets

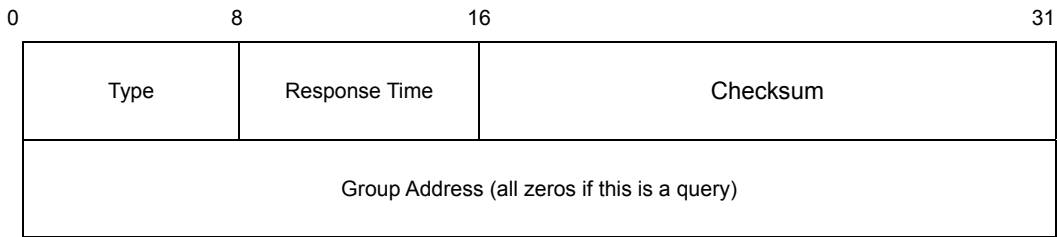

The IGMP Type codes are shown below:

Type	Meaning
0x11	Membership Query (if Group Address is 0.0.0.0)
0x11	Specific Group Membership Query (if Group Address is Present)
0x16	Membership Report (version 2)
0x17	Leave a Group (version 2)
0x12	Membership Report (version 1)

IGMP packets enable multicast routers to keep track of the membership of multicast groups, on their respective sub networks.

The following outlines what is communicated between a multicast router and a multicast group member using IGMP.

A host sends an IGMP “**report**” to join a group

A host will never send a report when it wants to leave a group (for version 1).

A host will send a “**leave**” report when it wants to leave a group (for version 2).

Multicast routers send IGMP queries (to the all-hosts group address: 224.0.0.1) periodically to see whether any group members exist on their sub networks. If there is no response from a particular group, the router assumes that there are no group members on the network.

The Time-to-Live (TTL) field of query messages is set to 1 so that the queries will not be forwarded to other sub networks.

IGMP version 2 introduces some enhancements such as a method to elect a multicast queried for each LAN, an explicit leave

message, and query messages that are specific to a given group.

The states a computer will go through to join or to leave a multicast group are shown below:

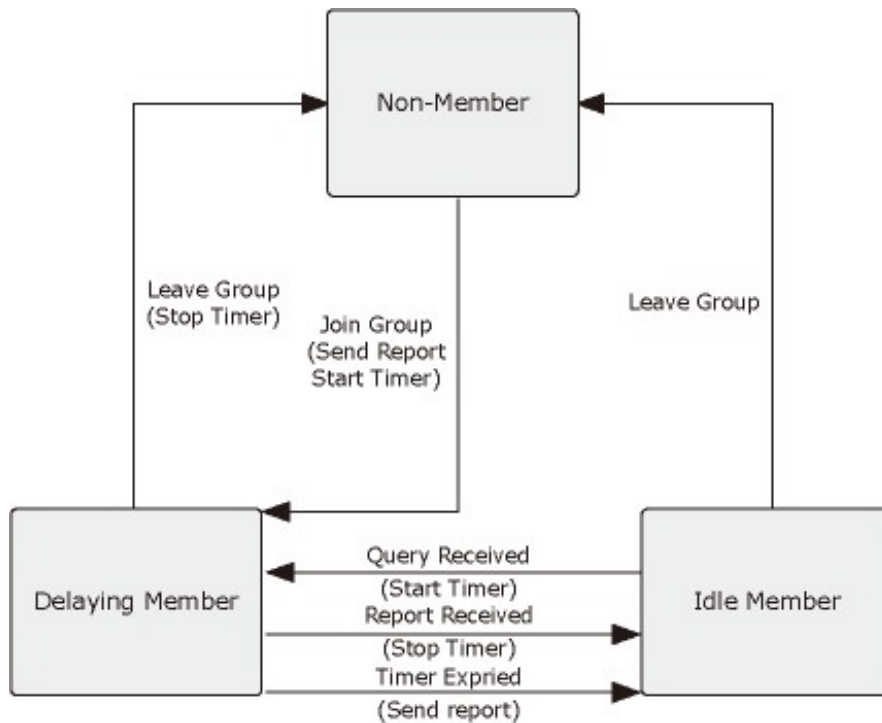

Figure 4-8-4: IGMP State Transitions

■ **IGMP Querier –**

A router, or multicast-enabled switch, can periodically ask their hosts if they want to receive multicast traffic. If there is more than one router/switch on the LAN performing IP multicasting, one of these devices is elected “**querier**” and assumes the role of querying the LAN for group members. It then propagates the service requests on to any upstream multicast switch/router to ensure that it will continue to receive the multicast service.



Multicast routers use this information, along with a multicast routing protocol such as DVMRP or PIM, to support IP multicasting across the Internet.

4.8.2 IGMP Snooping Configuration

This page provides IGMP Snooping related configuration. The IGMP Snooping Configuration screen in [Figure 4-8-5](#) appears.

IGMP Snooping Configuration

Global Configuration	
Snooping Enabled	<input type="checkbox"/>
Unregistered IPMCv4 Flooding Enabled	<input type="checkbox"/>
IGMP SSM Range	232.0.0.0 / 8
Leave Proxy Enabled	<input type="checkbox"/>
Proxy Enabled	<input type="checkbox"/>

Port Related Configuration

Port	Router Port	Fast Leave	Throttling
*	<All> ▼	<input type="checkbox"/>	<All> ▼
1	Auto ▼	<input type="checkbox"/>	unlimited ▼
2	Auto ▼	<input type="checkbox"/>	unlimited ▼
3	Auto ▼	<input type="checkbox"/>	unlimited ▼
4	Auto ▼	<input type="checkbox"/>	unlimited ▼
5	Auto ▼	<input type="checkbox"/>	unlimited ▼
6	Auto ▼	<input type="checkbox"/>	unlimited ▼
7	Auto ▼	<input type="checkbox"/>	unlimited ▼
8	Auto ▼	<input type="checkbox"/>	unlimited ▼
9	Auto ▼	<input type="checkbox"/>	unlimited ▼
10	Auto ▼	<input type="checkbox"/>	unlimited ▼

Figure 4-8-5: IGMP Snooping Configuration Page Screenshot

The page includes the following fields:

Object	Description
• Snooping Enabled	Enable the Global IGMP Snooping.
• Unregistered IPMCv4 Flooding enabled	Enable unregistered IPMCv4 traffic flooding.
• IGMP SSM Range	SSM (Source-Specific Multicast) Range allows the SSM-aware hosts and routers run the SSM service model for the groups in the address range.
• Leave Proxy Enable	Enable IGMP Leave Proxy. This feature can be used to avoid forwarding unnecessary leave messages to the router side.
• Proxy Enable	Enable IGMP Proxy. This feature can be used to avoid forwarding unnecessary join and leave messages to the router side.
• Router Port	Specify which ports act as router ports. A router port is a port on the Ethernet switch that leads towards the Layer 3 multicast device or IGMP querier.

	If an aggregation member port is selected as a router port, the whole aggregation will act as a router port. All means all ports will have one specific setting.
• Fast Leave	Enable the fast leave on the port.
• Throttling	The Configuration All with available values will assign to whole items. Enable to limit the number of multicast groups to which a switch port can belong. All means all ports will have one specific setting.

Buttons



: Click to save changes.



: Click to undo any changes made locally and revert to previously saved values.

4.8.3 IGMP Snooping VLAN Configuration

Each page shows up to 99 entries from the VLAN table, default being 20, selected through the "entries per page" input field. When first visited, the web page will show the first 20 entries from the beginning of the VLAN Table. The first displayed will be the one with the lowest VLAN ID found in the VLAN Table.

The "VLAN" input fields allow the user to select the starting point in the VLAN Table. The IGMP Snooping VLAN Configuration screen in [Figure 4-8-6](#) appears.

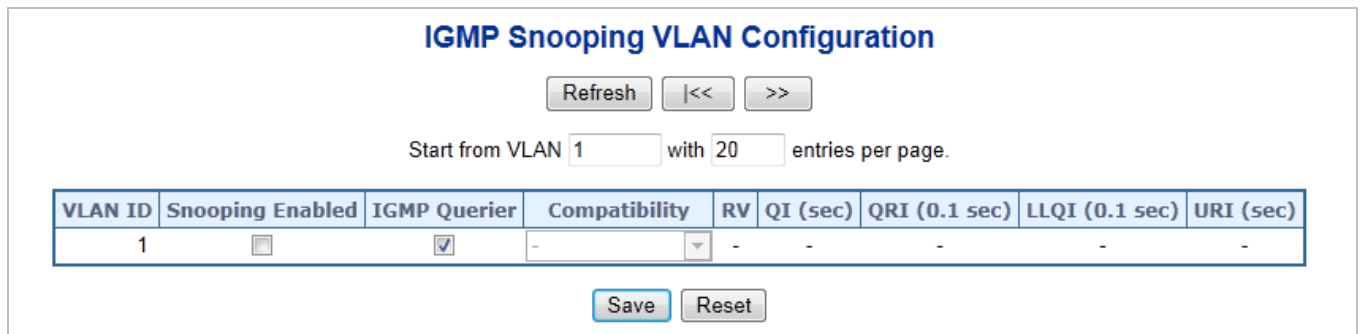

Figure 4-8-6: IGMP Snooping VLAN Configuration Page Screenshot

The page includes the following fields:

Object	Description
• VLAN ID	The VLAN ID of the entry.
• IGMP Snooping Enable	Enable the per-VLAN IGMP Snooping. Only up to 64 VLANs can be selected.
• IGMP Querier	Enable the IGMP Querier in the VLAN.
• Compatibility	Compatibility is maintained by hosts and routers taking appropriate actions depending on the versions of IGMP operating on hosts and routers within a

	network. The allowed selection is IGMP-Auto, Forced IGMPv1, Forced IGMPv2, Forced IGMPv3, default compatibility value is IGMP-Auto.
• RV	Robustness Variable. The Robustness Variable allows tuning for the expected packet loss on a network. The allowed range is 1 to 255, default robustness variable value is 2.
• QI	Query Interval. The Query Interval is the interval between General Queries sent by the Querier. The allowed range is 1 to 255 seconds, default query interval is 125 seconds.
• QRI	Query Response Interval. The Max Response Time used to calculate the Max Resp Code inserted into the periodic General Queries. The allowed range is 0 to 31744 in tenths of seconds, default query response interval is 100 in tenths of seconds (10 seconds).
• LLQI (LMQI for IGMP)	Last Member Query Interval. The Last Member Query Time is the time value represented by the Last Member Query Interval, multiplied by the Last Member Query Count. The allowed range is 0 to 31744 in tenths of seconds, default last member query interval is 10 in tenths of seconds (1 second).
• URI	Unsolicited Report Interval. The Unsolicited Report Interval is the time between repetitions of a host's initial report of membership in a group. The allowed range is 0 to 31744 seconds, default unsolicited report interval is 1 second.

Buttons

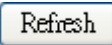
: Refreshes the displayed table starting from the "VLAN" input fields.

: Updates the table starting from the first entry in the VLAN Table, i.e. the entry with the lowest VLAN ID.

: Updates the table, starting with the entry after the last entry currently displayed.

: Click to save changes.

: Click to undo any changes made locally and revert to previously saved values.

4.8.4 IGMP Snooping Port Group Filtering

In certain switch applications, the administrator may want to control the multicast services that are available to end users. For example, an IP/TV service based on a specific subscription plan. The IGMP filtering feature fulfills this requirement by restricting access to specified multicast services on a switch port, and IGMP throttling limits the number of simultaneous multicast groups a port can join.

IGMP filtering enables you to assign a profile to a switch port that specifies multicast groups that are permitted or denied on the port. An IGMP filter profile can contain one or more, or a range of multicast addresses; but only one profile can be assigned to a port. When enabled, IGMP join reports received on the port are checked against the filter profile. If a requested multicast group is permitted, the IGMP join report is forwarded as normal. If a requested multicast group is denied, the IGMP join report is dropped.

IGMP throttling sets a maximum number of multicast groups that a port can join at the same time. When the maximum number of groups is reached on a port, the switch can take one of two actions; either "deny" or "replace". If the action is set to deny, any new IGMP join reports will be dropped. If the action is set to replace, the switch randomly removes an existing group and replaces it with the new multicast group. The IGMP Snooping Port Group Filtering Configuration screen in [Figure 4-8-7](#) appears.

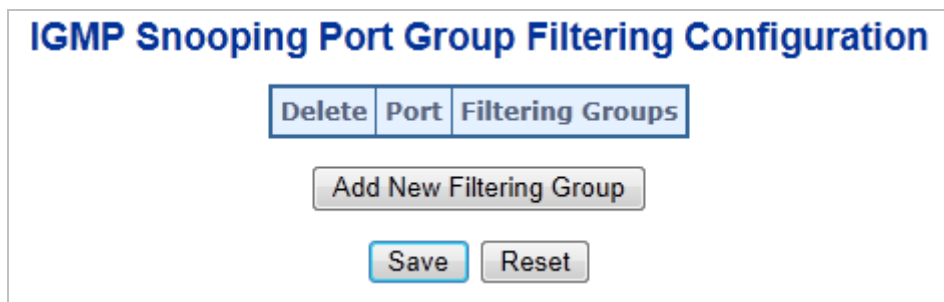

Figure 4-8-7: IGMP Snooping Port Group Filtering Configuration Page Screenshot

The page includes the following fields:

Object	Description
• Delete	Check to delete the entry. It will be deleted during the next save.
• Port	The logical port for the settings.
• Filtering Group	The IP Multicast Group that will be filtered.

Buttons

Add New Filtering Group: Click to add a new entry to the Group Filtering table.

Save: Click to save changes.

Reset: Click to undo any changes made locally and revert to previously saved values.

4.8.5 IGMP Snooping Status

This page provides IGMP Snooping status. The IGMP Snooping Status screen in [Figure 4-8-8](#) appears.

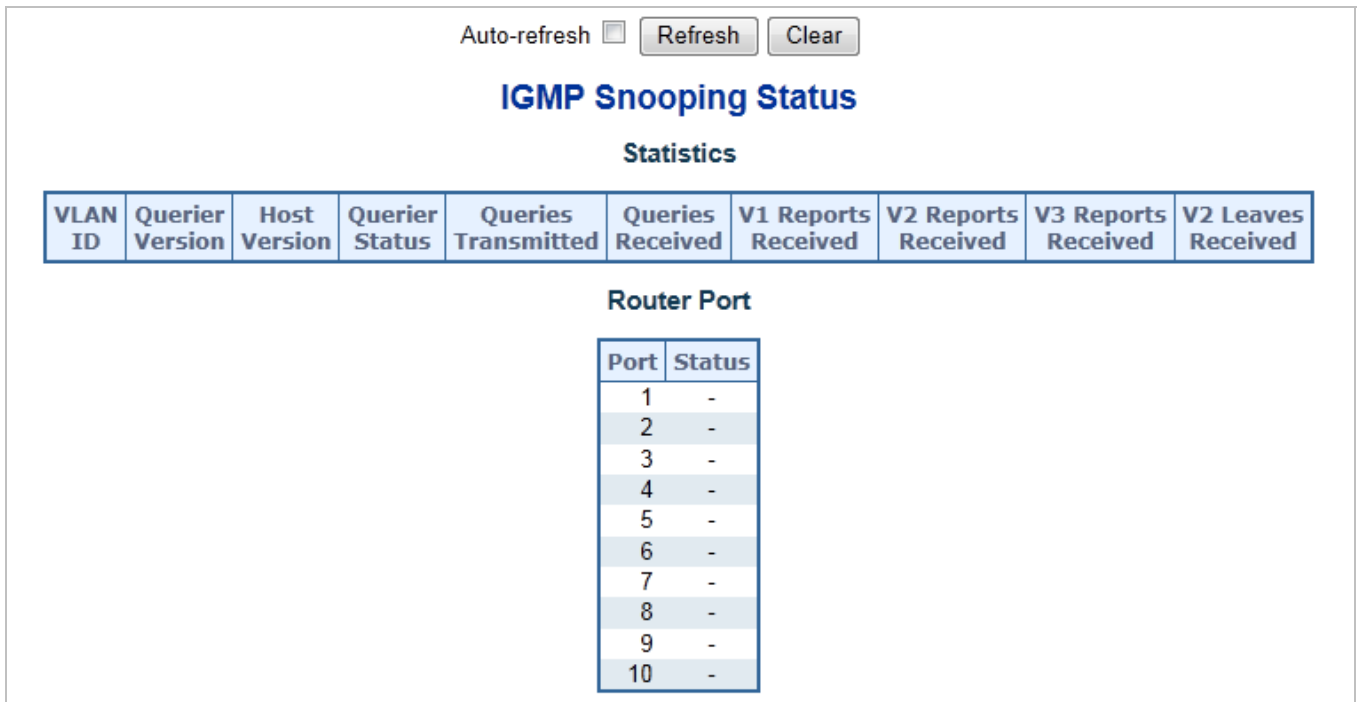

Figure 4-8-8: IGMP Snooping Status Page Screenshot

The page includes the following fields:

Object	Description
• VLAN ID	The VLAN ID of the entry
• Querier Version	Working Querier Version currently
• Host Version	Working Host Version currently
• Querier Status	Show the Querier status is "ACTIVE" or "IDLE"
• Queries Transmitted	The number of Transmitted Queries
• Queries Received	The number of Received Queries
• V1 Reports Received	The number of Received V1 Reports
• V2 Reports Received	The number of Received V2 Reports
• V3 Reports Received	The number of Received V3 Reports
• V2 Leaves Received	The number of Received V2 Leaves

Buttons

Auto-refresh : Check this box to refresh the page automatically. Automatic refresh occurs every 3 seconds.

: Click to refresh the page immediately.

: Clears all Statistics counters.

4.8.6 IGMP Group Information

Entries in the IGMP Group Table are shown on this page. The IGMP Group Table is sorted first by VLAN ID, and then by group. Each page shows up to 99 entries from the IGMP Group table, default being 20, selected through the "entries per page" input field. When first visited, the web page will show the first 20 entries from the beginning of the IGMP Group Table. The "Start from VLAN", and "group" input fields allow the user to select the starting point in the IGMP Group Table. The IGMP Groups Information screen in [Figure 4-8-9](#) appears.

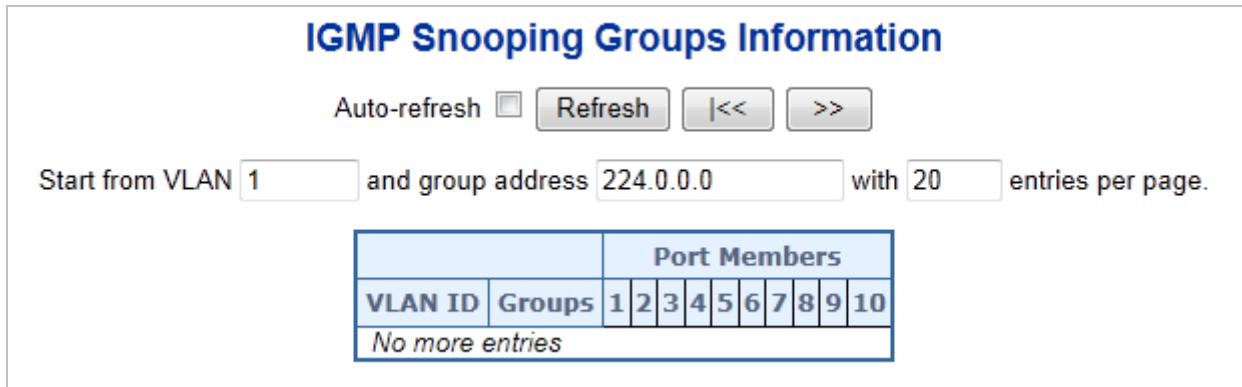

Figure 4-8-9: IGMP Snooping Groups Information Page Screenshot

The page includes the following fields:

Object	Description
• VLAN ID	VLAN ID of the group.
• Groups	Group address of the group displayed.
• Port Members	Ports under this group.

Buttons

Auto-refresh : Check this box to refresh the page automatically. Automatic refresh occurs every 3 seconds.

: Click to refresh the page immediately.

: Updates the table, starting with the first entry in the IGMP Group Table.

: Updates the table, starting with the entry after the last entry currently displayed.

4.8.7 IGMPv3 Information

Entries in the IGMP SFM Information Table are shown on this page. The IGMP SFM (Source-Filtered Multicast) Information Table also contains the SSM (Source-Specific Multicast) information. This table is sorted first by VLAN ID, then by group, and then by Port No. Different source addresses belong to the same group are treated as single entry.

Each page shows up to 99 entries from the IGMP SFM Information table, default being 20, selected through the "entries per page" input field. When first visited, the web page will show the first 20 entries from the beginning of the IGMP SFM Information Table.

The "Start from VLAN", and "Group" input fields allow the user to select the starting point in the IGMP SFM Information Table. The IGMPv3 Information screen in [Figure 4-8-10](#) appears.

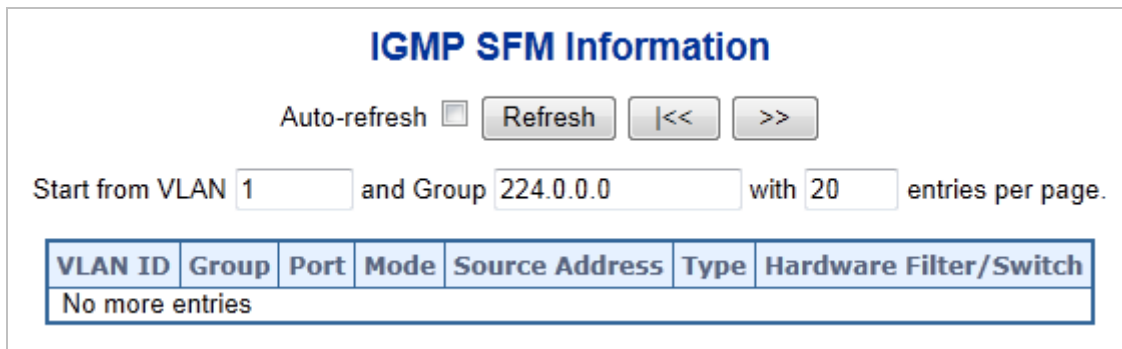

Figure 4-8-10: IGMP SFM Information Page Screenshot

The page includes the following fields:

Object	Description
• VLAN ID	VLAN ID of the group.
• Group	Group address of the group displayed.
• Port	Switch port number.
• Mode	Indicates the filtering mode maintained per (VLAN ID, port number, Group Address) basis. It can be either Include or Exclude.
• Source Address	IP Address of the source. Currently, system limits the total number of IP source addresses for filtering to be 128.
• Type	Indicates the Type. It can be either Allow or Deny.
• Hardware Filter / Switch	Indicates whether data plane destined to the specific group address from the source IPv4 address could be handled by chip or not.

Buttons

Auto-refresh : Check this box to refresh the page automatically. Automatic refresh occurs every 3 seconds.

: Click to refresh the page immediately.

: Updates the table, starting with the first entry in the IGMP Group Table.

: Updates the table, starting with the entry after the last entry currently displayed.

4.8.8 MLD Snooping Configuration

This page provides MLD Snooping related configuration. The MLD Snooping Configuration screen in [Figure 4-8-11](#) appears.

MLD Snooping Configuration

Global Configuration

Snooping Enabled	<input type="checkbox"/>
Unregistered IPMCv6 Flooding Enabled	<input type="checkbox"/>
MLD SSM Range	ff3e:: / 96
Leave Proxy Enabled	<input type="checkbox"/>
Proxy Enabled	<input type="checkbox"/>

Port Related Configuration

Port	Router Port	Fast Leave	Throttling
*	<All> ▼	<input type="checkbox"/>	<All> ▼
1	Auto ▼	<input type="checkbox"/>	unlimited ▼
2	Auto ▼	<input type="checkbox"/>	unlimited ▼
3	Auto ▼	<input type="checkbox"/>	unlimited ▼
4	Auto ▼	<input type="checkbox"/>	unlimited ▼
5	Auto ▼	<input type="checkbox"/>	unlimited ▼
6	Auto ▼	<input type="checkbox"/>	unlimited ▼
7	Auto ▼	<input type="checkbox"/>	unlimited ▼
8	Auto ▼	<input type="checkbox"/>	unlimited ▼
9	Auto ▼	<input type="checkbox"/>	unlimited ▼
10	Auto ▼	<input type="checkbox"/>	unlimited ▼

Figure 4-8-11: MLD Snooping Configuration Page Screenshot

The page includes the following fields:

Object	Description
• Snooping Enabled	Enable the Global MLD Snooping.
• Unregistered IPMCv6 Flooding Enabled	Enable unregistered IPMCv6 traffic flooding. Please note that disabling unregistered IPMCv6 traffic flooding may lead to failure of Neighbor Discovery.
• MLD SSM Range	SSM (Source-Specific Multicast) Range allows the SSM-aware hosts and routers run the SSM service model for the groups in the address range.
• Leave Proxy Enable	Enable MLD Leave Proxy. This feature can be used to avoid forwarding unnecessary leave messages to the router side.
• Proxy Enable	Enable MLD Proxy. This feature can be used to avoid forwarding unnecessary join and leave messages to the router side.

<ul style="list-style-type: none"> • Router Port 	<p>Specify which ports act as router ports. A router port is a port on the Ethernet switch that leads towards the Layer 3 multicast device or MLD querier.</p> <p>If an aggregation member port is selected as a router port, the whole aggregation will act as a router port. All means all ports will have one specific setting.</p>
<ul style="list-style-type: none"> • Fast Leave 	<p>Enable the fast leave on the port.</p>
<ul style="list-style-type: none"> • Throtting 	<p>The Configuration All with available values will assign to whole items.</p> <p>Enable to limit the number of multicast groups to which a switch port can belong.</p> <p>All means all ports will have one specific setting.</p>

Buttons

: Click to save changes.

: Click to undo any changes made locally and revert to previously saved values.

4.8.9 MLD Snooping VLAN Configuration

Each page shows up to 99 entries from the VLAN table, default being 20, selected through the "entries per page" input field. When first visited, the web page will show the first 20 entries from the beginning of the VLAN Table. The first displayed will be the one with the lowest VLAN ID found in the VLAN Table.

The "VLAN" input fields allow the user to select the starting point in the VLAN Table. The MLD Snooping VLAN Configuration screen in [Figure 4-8-12](#) appears.

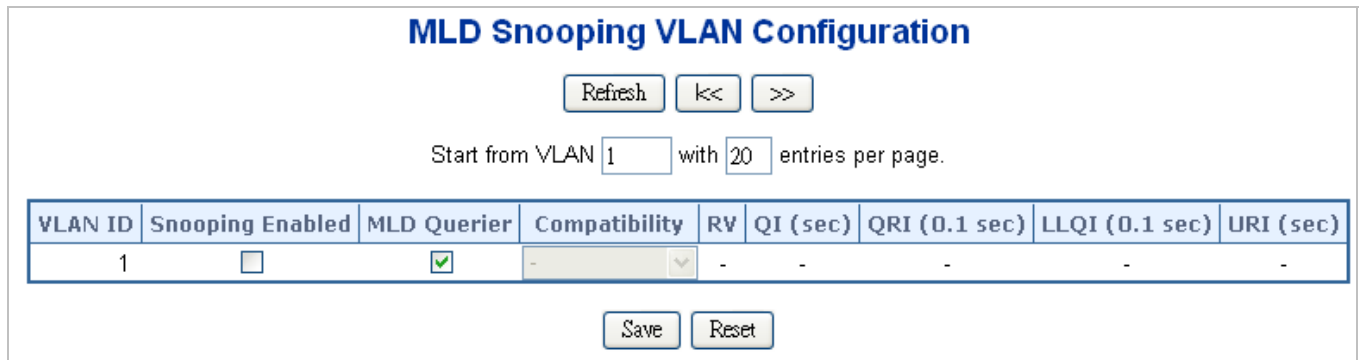

Figure 4-8-12: IGMP Snooping VLAN Configuration Page Screenshot

The page includes the following fields:

Object	Description
<ul style="list-style-type: none"> • VLAN ID 	The VLAN ID of the entry.
<ul style="list-style-type: none"> • MLD Snooping Enable 	Enable the per-VLAN MLD Snooping. Only up to 64 VLANs can be selected.
<ul style="list-style-type: none"> • MLD Querier 	Enable the MLD Querier in the VLAN.

<ul style="list-style-type: none"> • Compatibility 	<p>Compatibility is maintained by hosts and routers taking appropriate actions depending on the versions of MLD operating on hosts and routers within a network. The allowed selection is MLD-Auto, Forced MLDv1, Forced MLDv2, default compatibility value is MLD-Auto.</p>
<ul style="list-style-type: none"> • RV 	<p>Robustness Variable. The Robustness Variable allows tuning for the expected packet loss on a link. The allowed range is 1 to 255, default robustness variable value is 2.</p>
<ul style="list-style-type: none"> • QI 	<p>Query Interval. The Query Interval variable denotes the interval between General Queries sent by the Querier. The allowed range is 1 to 255 seconds, default query interval is 125 seconds.</p>
<ul style="list-style-type: none"> • QRI 	<p>Query Response Interval. The Maximum Response Delay used to calculate the Maximum Response Code inserted into the periodic General Queries. The allowed range is 0 to 31744 in tenths of seconds, default query response interval is 100 in tenths of seconds (10 seconds).</p>
<ul style="list-style-type: none"> • LLQI 	<p>Last Listener Query Interval. The Last Listener Query Interval is the Maximum Response Delay used to calculate the Maximum Response Code inserted into Multicast Address Specific Queries sent in response to Version 1 Multicast Listener Done messages. It is also the Maximum Response Delay used to calculate the Maximum Response Code inserted into Multicast Address and Source Specific Query messages. The allowed range is 0 to 31744 in tenths of seconds, default last listener query interval is 10 in tenths of seconds (1 second).</p>
<ul style="list-style-type: none"> • URI 	<p>Unsolicited Report Interval. The Unsolicited Report Interval is the time between repetitions of a node's initial report of interest in a multicast address. The allowed range is 0 to 31744 seconds, default unsolicited report interval is 1 second.</p>

Buttons

: Refreshes the displayed table starting from the "VLAN" input fields.

: Updates the table starting from the first entry in the VLAN Table, i.e. the entry with the lowest VLAN ID.

: Updates the table, starting with the entry after the last entry currently displayed.

: Click to save changes.

: Click to undo any changes made locally and revert to previously saved values.

4.8.10 MLD Snooping Port Group Filtering

In certain switch applications, the administrator may want to control the multicast services that are available to end users. For example, an IP/TV service based on a specific subscription plan. The MLD filtering feature fulfills this requirement by restricting access to specified multicast services on a switch port, and MLD throttling limits the number of simultaneous multicast groups a port can join.

MLD filtering enables you to assign a profile to a switch port that specifies multicast groups that are permitted or denied on the port. A MLD filter profile can contain one or more, or a range of multicast addresses; but only one profile can be assigned to a port. When enabled, MLD join reports received on the port are checked against the filter profile. If a requested multicast group is permitted, the MLD join report is forwarded as normal. If a requested multicast group is denied, the MLD join report is dropped.

MLD throttling sets a maximum number of multicast groups that a port can join at the same time. When the maximum number of groups is reached on a port, the switch can take one of two actions; either "deny" or "replace". If the action is set to deny, any new MLD join reports will be dropped. If the action is set to replace, the switch randomly removes an existing group and replaces it with the new multicast group. The MLD Snooping Port Group Filtering Configuration screen in [Figure 4-8-13](#) appears.

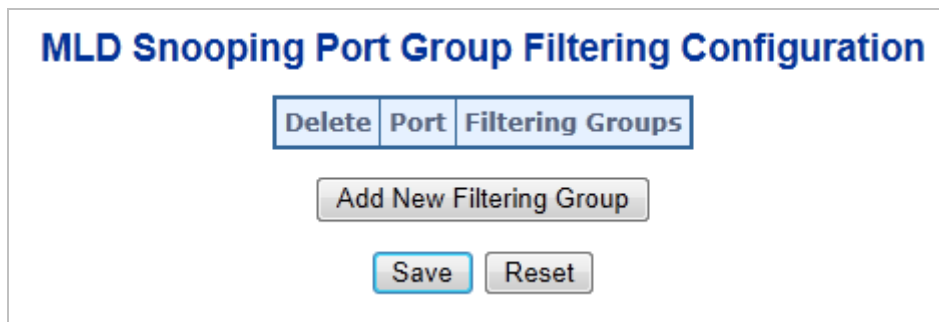

Figure 4-8-13: MLD Snooping Port Group Filtering Configuration Page Screenshot

The page includes the following fields:

Object	Description
• Delete	Check to delete the entry. It will be deleted during the next save.
• Port	The logical port for the settings.
• Filtering Group	The IP Multicast Group that will be filtered.

Buttons

Add New Filtering Group: Click to add a new entry to the Group Filtering table.

Save: Click to save changes.

Reset: Click to undo any changes made locally and revert to previously saved values.

4.8.11 MLD Snooping Status

This page provides MLD Snooping status. The IGMP Snooping Status screen in [Figure 4-8-14](#) appears.

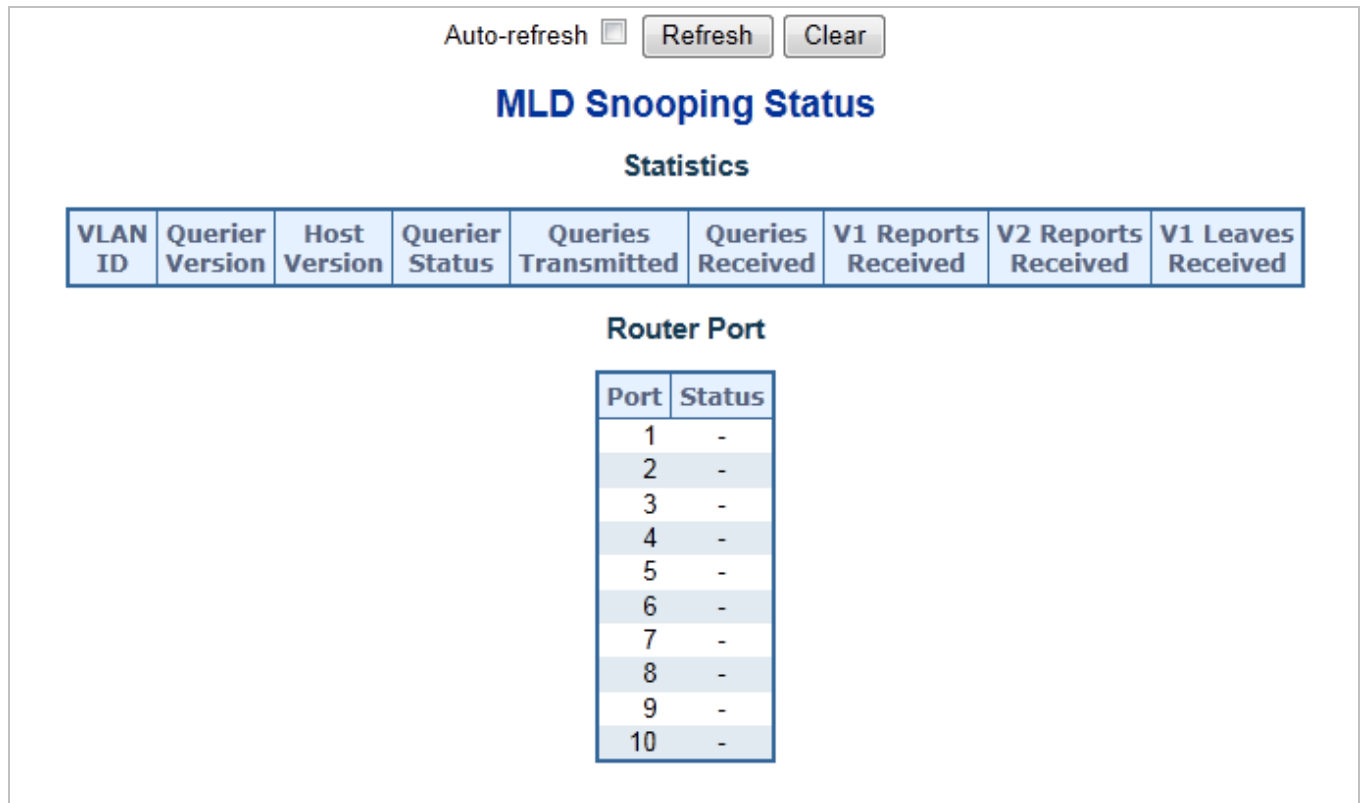

Figure 4-8-14: MLD Snooping Status Page Screenshot

The page includes the following fields:

Object	Description
• VLAN ID	The VLAN ID of the entry
• Querier Version	Working Querier Version currently
• Host Version	Working Host Version currently
• Querier Status	Show the Querier status is "ACTIVE" or "IDLE."
• Queriers Transmitted	The number of Transmitted Queriers
• Queriers Received	The number of Received Queriers
• V1 Reports Received	The number of Received V1 Reports
• V2 Reports Received	The number of Received V2 Reports
• V1 Leave Received	The number of Received V1 Leaves

Buttons

Auto-refresh : Check this box to refresh the page automatically. Automatic refresh occurs every 3 seconds.

: Click to refresh the page immediately.

: Clears MLD Snooping Status counters.

4.8.12 MLD Groups Information

Entries in the MLD Group Table are shown on this page. The MLD Group Table is sorted first by VLAN ID, and then by group. Each page shows up to 99 entries from the MLD Group table, default being 20, selected through the "entries per page" input field. When first visited, the web page will show the first 20 entries from the beginning of the MLD Group Table.

The "Start from VLAN", and "group" input fields allow the user to select the starting point in the MLD Group Table.

The MLD Groups Information screen in [Figure 4-8-15](#) appears.

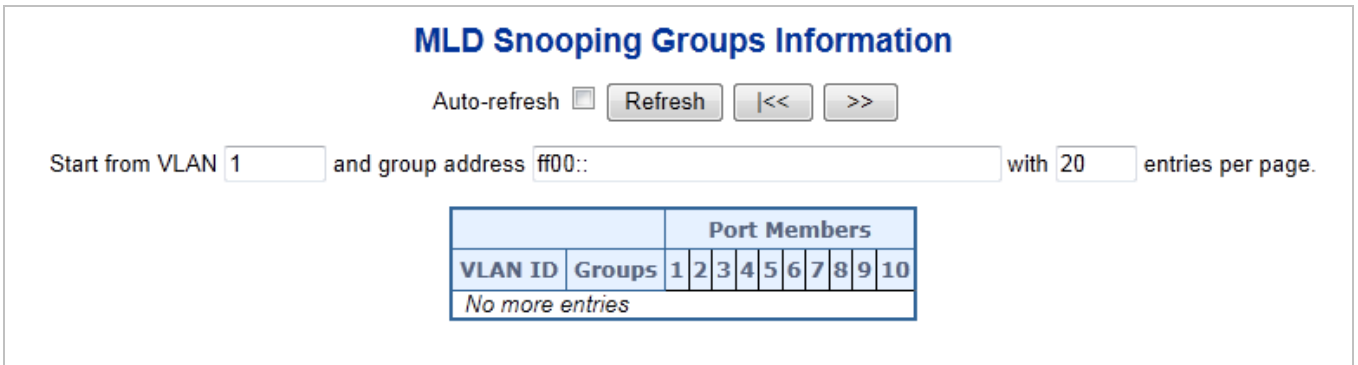

Figure 4-8-15: MLD Snooping Groups Information Page Screenshot

The page includes the following fields:

Object	Description
• VLAN ID	VLAN ID of the group.
• Groups	Group address of the group displayed.
• Port Members	Ports under this group.

Buttons

Auto-refresh : Check this box to refresh the page automatically. Automatic refresh occurs every 3 seconds.

: Click to refresh the page immediately.

: Updates the table, starting with the first entry in the MLD Group Table.

: Updates the table, starting with the entry after the last entry currently displayed.

4.8.13 MLDv2 Information

Entries in the MLD SFM Information Table are shown on this page. The MLD **SFM (Source-Filtered Multicast)** Information Table also contains the **SSM (Source-Specific Multicast)** information. This table is sorted first by VLAN ID, then by group, and then by Port No. Different source addresses belong to the same group are treated as single entry.

Each page shows up to 64 entries from the MLD SFM Information table, default being 20, selected through the "entries per page" input field. When first visited, the web page will show the first 20 entries from the beginning of the MLD SFM Information Table.

The "Start from VLAN", and "Group" input fields allow the user to select the starting point in the MLD SSM Information Table. The MLDv2 Information screen in [Figure 4-8-16](#) appears.

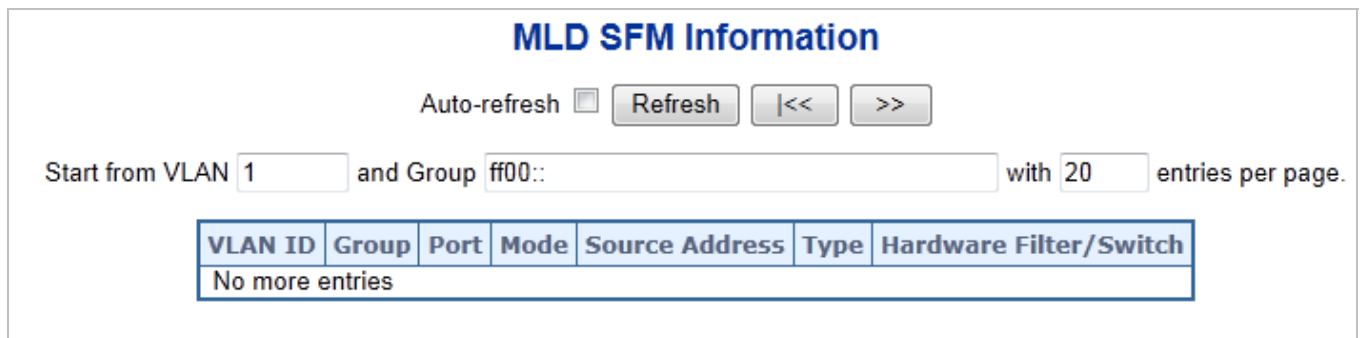

Figure 4-8-16: MLD SSM Information Page Screenshot

The page includes the following fields:

Object	Description
• VLAN ID	VLAN ID of the group.
• Group	Group address of the group displayed.
• Port	Switch port number.
• Mode	Indicates the filtering mode maintained per (VLAN ID, port number, Group Address) basis. It can be either Include or Exclude.
• Source Address	IP Address of the source. Currently, system limits the total number of IP source addresses for filtering to be 128.
• Type	Indicates the Type. It can be either Allow or Deny.
• Hardware Filter / Switch	Indicates whether data plane destined to the specific group address from the source IPv6 address could be handled by chip or not.

Buttons

Auto-refresh : Check this box to refresh the page automatically. Automatic refresh occurs every 3 seconds.

: Click to refresh the page immediately.

: Updates the table starting from the first entry in the MLD SFM Information.

: Updates the table, starting with the entry after the last entry currently displayed.

4.8.14 MVR

The MVR feature enables multicast traffic forwarding on the Multicast VLANs. In a multicast television application, a PC or a network television or a set-top box can receive the multicast stream. Multiple set-top boxes or PCs can be connected to one subscriber port, which is a switch port configured as an MVR receiver port. When a subscriber selects a channel, the set-top box or PC sends an IGMP/MLD report message to Switch A to join the appropriate multicast group address. Uplink ports that send and receive multicast data to and from the multicast VLAN are called MVR source ports. It is allowed to create at maximum 8 MVR VLANs with corresponding channel settings for each Multicast VLAN. There will be totally at maximum 256 group addresses for channel settings.

This page provides MVR related configuration. The MVR screen in [Figure 4-8-17](#) appears.

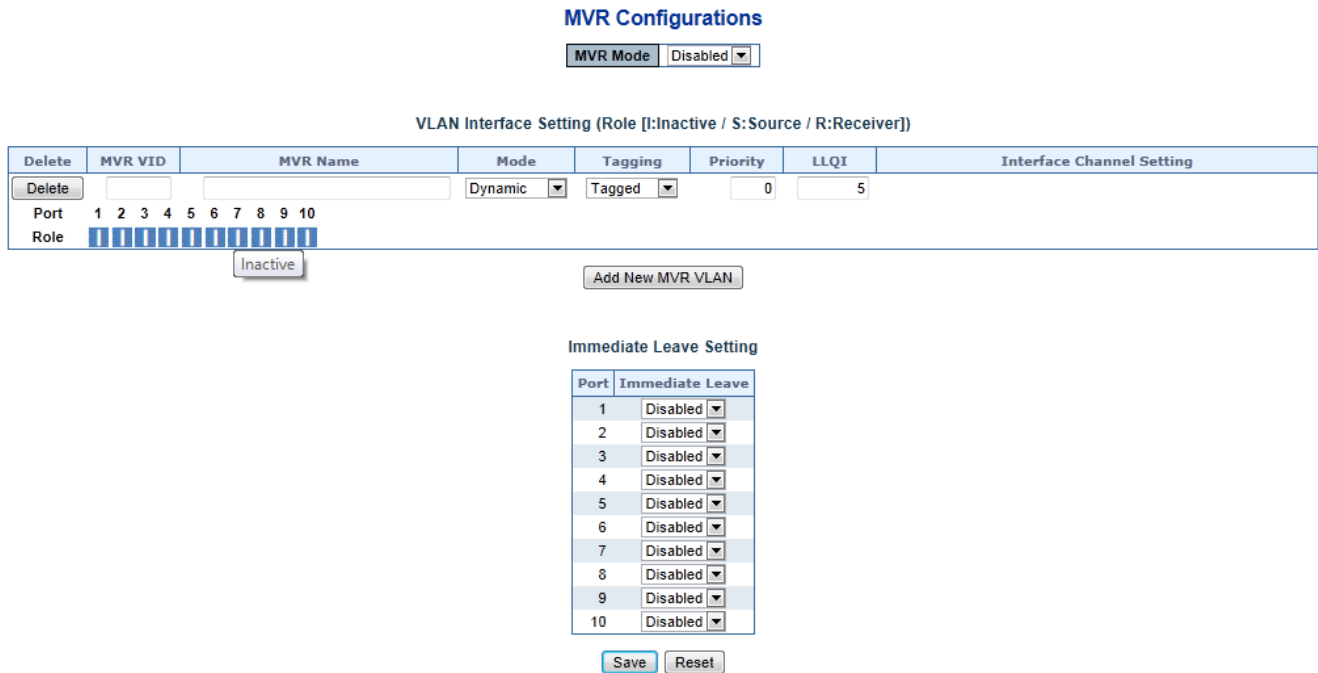

Figure 4-8-17: MVR Configuration Page Screenshot

The page includes the following fields:

Object	Description
<ul style="list-style-type: none"> MVR Mode 	<p>Enable/Disable the Global MVR.</p> <p>The Unregistered Flooding control depends on the current configuration in IGMP/MLD Snooping.</p> <p>It is suggested to enable Unregistered Flooding control when the MVR group table is full.</p>

<ul style="list-style-type: none"> • Delete 	<p>Check to delete the entry. The designated entry will be deleted during the next save.</p>
<ul style="list-style-type: none"> • MVR VID 	<p>Specify the Multicast VLAN ID.</p> <p>Be Caution: MVR source ports are not recommended to be overlapped with management VLAN ports.</p>
<ul style="list-style-type: none"> • MVR Name 	<p>MVR Name is an optional attribute to indicate the name of the specific MVR VLAN. Maximum length of the MVR VLAN Name string is 32. MVR VLAN Name can only contain alphabets or numbers. When the optional MVR VLAN name is given, it should contain at least one alphabet. MVR VLAN name can be edited for the existing MVR VLAN entries or it can be added to the new entries.</p>
<ul style="list-style-type: none"> • Mode 	<p>Specify the MVR mode of operation.</p> <ul style="list-style-type: none"> ■ In Dynamic mode, MVR allows dynamic MVR membership reports on source ports. ■ In Compatible mode, MVR membership reports are forbidden on source ports. <p>The default is Dynamic mode.</p>
<ul style="list-style-type: none"> • Tagging 	<p>Specify whether the traversed IGMP/MLD control frames will be sent as Untagged or Tagged with MVR VID.</p> <p>The default is Tagged.</p>
<ul style="list-style-type: none"> • Priority 	<p>Specify how the traversed IGMP/MLD control frames will be sent in prioritized manner.</p> <p>The default Priority is 0.</p>
<ul style="list-style-type: none"> • LLQI 	<p>Define the maximum time to wait for IGMP/MLD report memberships on a receiver port before removing the port from multicast group membership. The value is in units of tenths of a seconds.</p> <p>The range is from 0 to 31744.</p> <p>The default LLQI is 5 tenths or one-half second.</p>
<ul style="list-style-type: none"> • Interface Channel Setting 	<p>When the MVR VLAN is created, click the Edit symbol to expand the corresponding multicast channel settings for the specific MVR VLAN. Summary about the Interface Channel Setting (of the MVR VLAN) will be shown besides the Edit symbol.</p>
<ul style="list-style-type: none"> • Port 	<p>The logical port for the settings.</p>
<ul style="list-style-type: none"> • Port Role 	<p>Configure an MVR port of the designated MVR VLAN as one of the following roles.</p> <ul style="list-style-type: none"> ■ Inactive: The designated port does not participate MVR operations. ■ Source: Configure uplink ports that receive and send multicast data as source ports. Subscribers cannot be directly connected to source ports. ■ Receiver: Configure a port as a receiver port if it is a subscriber port and should only receive multicast data. It does not receive data unless it

	<p>becomes a member of the multicast group by issuing IGMP/MLD messages.</p> <p>Be Caution: MVR source ports are not recommended to be overlapped with management VLAN ports.</p> <p>Select the port role by clicking the Role symbol to switch the setting.</p> <p>I indicates Inactive; S indicates Source; R indicates Receiver</p> <p>The default Role is Inactive.</p>
<ul style="list-style-type: none"> • Immediate Leave 	<p>Enable the fast leave on the port.</p>

Buttons

Add New MVR VLAN : Click to add new MVR VLAN. Specify the VID and configure the new entry. Click "Save"

Save : Click to save changes.

Reset : Click to undo any changes made locally and revert to previously saved values.

4.8.15 MVR Status

This page provides MVR status. The MVR Status screen in [Figure 4-8-18](#) appears.

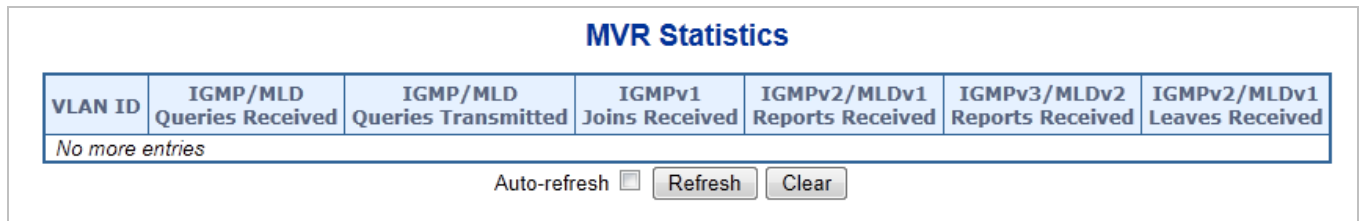

Figure 4-8-18: MVR Status Page Screenshot

The page includes the following fields:

Object	Description
<ul style="list-style-type: none"> • VLAN ID 	The Multicast VLAN ID.
<ul style="list-style-type: none"> • IGMP/MLD Queries Received 	The number of Received Queries for IGMP and MLD, respectively.
<ul style="list-style-type: none"> • IGMP/MLD Queries Transmitted 	The number of Transmitted Queries for IGMP and MLD, respectively.
<ul style="list-style-type: none"> • IGMPv1 Joins Received 	The number of Received IGMPv1 Joins.
<ul style="list-style-type: none"> • IGMPv2/MLDv1 Reports Received 	The number of Received IGMPv2 Joins and MLDv1 Reports, respectively.
<ul style="list-style-type: none"> • IGMPv3/MLDv2 Reports Received 	The number of Received IGMPv3 Joins and MLDv2 Reports, respectively.
<ul style="list-style-type: none"> • IGMPv2/MLDv1 Leaves Received 	The number of Received IGMPv2 Leaves and MLDv1 Dones, respectively.

Buttons

Auto-refresh : Check this box to refresh the page automatically. Automatic refresh occurs every 3 seconds.

: Click to refresh the page immediately.

: Clears MVR Statistics counters.

4.8.16 MVR Groups Information

Entries in the MVR Group Table are shown on this page. The MVR Group Table is sorted first by VLAN ID, and then by group. Each page shows up to 99 entries from the MVR Group table, default being 20, selected through the "entries per page" input field. When first visited, the web page will show the first 20 entries from the beginning of the MVR Group Table.

The "Start from VLAN", and "group" input fields allow the user to select the starting point in the MVR Group Table.

The MVR Groups Information screen in [Figure 4-8-19](#) appears.

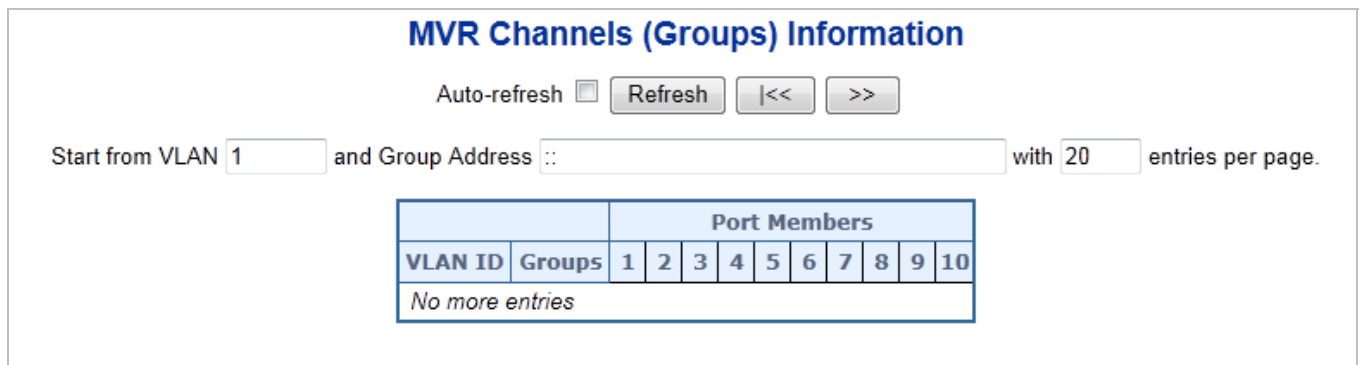

Figure 4-8-19: MVR Groups Information Page Screenshot

The page includes the following fields:

Object	Description
• VLAN ID	VLAN ID of the group.
• Groups	Group ID of the group displayed.
• Port Members	Ports under this group.

Buttons

Auto-refresh : Check this box to refresh the page automatically. Automatic refresh occurs every 3 seconds.

: Click to refresh the page immediately.

: Updates the table starting from the first entry in the MVR Channels (Groups) Information Table.

: Updates the table, starting with the entry after the last entry currently displayed.

4.8.17 MVR SFM Information

Entries in the MVR SFM Information Table are shown on this page. The MVR SFM (Source-Filtered Multicast) Information Table also contains the SSM (Source-Specific Multicast) information. This table is sorted first by VLAN ID, then by group, and then by Port. Different source addresses belong to the same group are treated as single entry.

The MVR Groups Information screen in [Figure 4-8-20](#) appears.

Figure 4-8-20: MVR Groups Information Page Screenshot

The page includes the following fields:

Object	Description
• VLAN ID	VLAN ID of the group.
• Group	Group ID of the group displayed.
• Port	Switch port number.
• Mode	Indicates the filtering mode maintained per (VLAN ID, port number, Group Address) basis. It can be either Include or Exclude.
• Source Address	IP Address of the source. Currently, system limits the total number of IP source addresses for filtering to be 128. When there is no any source filtering address, the text "None" is shown in the Source Address field.
• Type	Indicates the Type. It can be either Allow or Deny.
• Hardware Filter / Switch	Indicates whether data plane destined to the specific group address from the source IPv6 address could be handled by chip or not.

Buttons

Auto-refresh : Check this box to refresh the page automatically. Automatic refresh occurs every 3 seconds.

: Click to refresh the page immediately.

: Updates the table starting from the first entry in the MVR SFM Information Table.

: Updates the table, starting with the entry after the last entry currently displayed.

4.9 Quality of Service

4.9.1 Understand QoS

Quality of Service (QoS) is an advanced traffic prioritization feature that allows you to establish control over network traffic. QoS enables you to assign various grades of network service to different types of traffic, such as multi-media, video, protocol-specific, time critical, and file-backup traffic.

QoS reduces bandwidth limitations, delay, loss, and jitter. It also provides increased reliability for delivery of your data and allows you to prioritize certain applications across your network. You can define exactly how you want the switch to treat selected applications and types of traffic. You can use QoS on your system to:

- Control a wide variety of network traffic by:
 - Classifying traffic based on packet attributes.
 - Assigning priorities to traffic (for example, to set higher priorities to time-critical or business-critical applications).
 - Applying security policy through traffic filtering.
 - Provide predictable throughput for multimedia applications such as video conferencing or voice over IP by minimizing delay and jitter.
 - Improve performance for specific types of traffic and preserve performance as the amount of traffic grows.
 - Reduce the need to constantly add bandwidth to the network.
 - Manage network congestion.

QoS Terminology

- **Classifier**—classifies the traffic on the network. Traffic classifications are determined by protocol, application, source, destination, and so on. You can create and modify classifications. The Switch then groups classified traffic in order to schedule them with the appropriate service level.
- **DiffServ Code Point (DSCP)** — is the traffic prioritization bits within an IP header that are encoded by certain applications and/or devices to indicate the level of service required by the packet across a network.
- **Service Level**—defines the priority that will be given to a set of classified traffic. You can create and modify service levels.
- **Policy**—comprises a set of “rules” that are applied to a network so that a network meets the needs of the business. That is, traffic can be prioritized across a network according to its importance to that particular business type.
- **QoS Profile**—consists of multiple sets of rules (classifier plus service level combinations). The QoS profile is assigned to a port(s).
- **Rules**—comprises a service level and a classifier to define how the Switch will treat certain types of traffic. Rules are associated with a QoS Profile (see above).

To implement QoS on your network, you need to carry out the following actions:

1. Define a service level to determine the priority that will be applied to traffic.
2. Apply a classifier to determine how the incoming traffic will be classified and thus treated by the Switch.
3. Create a QoS profile which associates a service level and a classifier.
4. Apply a QoS profile to a port(s).

4.9.2 Port Policing

This page allows you to configure the Policer settings for all switch ports. The Port Policing screen in [Figure 4-9-1](#) appears.

QoS Ingress Port Policers

Port	Enabled	Rate	Unit	Flow Control
*	<input type="checkbox"/>	500	<All> ▼	<input type="checkbox"/>
1	<input type="checkbox"/>	500	kbps ▼	<input type="checkbox"/>
2	<input type="checkbox"/>	500	kbps ▼	<input type="checkbox"/>
3	<input type="checkbox"/>	500	kbps ▼	<input type="checkbox"/>
4	<input type="checkbox"/>	500	kbps ▼	<input type="checkbox"/>
5	<input type="checkbox"/>	500	kbps ▼	<input type="checkbox"/>
6	<input type="checkbox"/>	500	kbps ▼	<input type="checkbox"/>
7	<input type="checkbox"/>	500	kbps ▼	<input type="checkbox"/>
8	<input type="checkbox"/>	500	kbps ▼	<input type="checkbox"/>
9	<input type="checkbox"/>	500	kbps ▼	<input type="checkbox"/>
10	<input type="checkbox"/>	500	kbps ▼	<input type="checkbox"/>

Figure 4-9-1: QoS Ingress Port Policers Page Screenshot

The page includes the following fields:

Object	Description
• Port	The port number for which the configuration below applies.
• Enabled	Controls whether the policer is enabled on this switch port, * means selection all ports of Industrial Managed Switch.
• Rate	Controls the rate for the policer. The default value is 500. This value is restricted to 100-1000000 when the "Unit" is "kbps" or "fps", and it is restricted to 1-3300 when the "Unit" is "Mbps" or "kfps".
• Unit	The Configuration All with available options will assign to whole ports. Controls the unit of measure for the policer rate as kbps, Mbps, fps or kfps. The default value is "kbps". All means all ports will have one specific setting.
• Flow Control	If flow control is enabled and the port is in flow control mode, then pause frames are sent instead of discarding frames.

Buttons

: Click to save changes.

: Click to undo any changes made locally and revert to previously saved values.

4.9.3 Port Classification

This page allows you to configure the basic QoS Ingress Classification settings for all switch ports. The Port Classification screen in [Figure 4-9-2](#) appears.

QoS Ingress Port Classification

Port	QoS Class	DP Level	PCP	DEI	Tag Class.	DSCP Based
*	<All> ▼	<All> ▼	<All> ▼	<All> ▼		<input type="checkbox"/>
1	0 ▼	0 ▼	0 ▼	0 ▼	Disabled	<input type="checkbox"/>
2	0 ▼	0 ▼	0 ▼	0 ▼	Disabled	<input type="checkbox"/>
3	0 ▼	0 ▼	0 ▼	0 ▼	Disabled	<input type="checkbox"/>
4	0 ▼	0 ▼	0 ▼	0 ▼	Disabled	<input type="checkbox"/>
5	0 ▼	0 ▼	0 ▼	0 ▼	Disabled	<input type="checkbox"/>
6	0 ▼	0 ▼	0 ▼	0 ▼	Disabled	<input type="checkbox"/>
7	0 ▼	0 ▼	0 ▼	0 ▼	Disabled	<input type="checkbox"/>
8	0 ▼	0 ▼	0 ▼	0 ▼	Disabled	<input type="checkbox"/>
9	0 ▼	0 ▼	0 ▼	0 ▼	Disabled	<input type="checkbox"/>
10	0 ▼	0 ▼	0 ▼	0 ▼	Disabled	<input type="checkbox"/>

Figure 4-9-2 : QoS Ingress Port Classification Page Screenshot

The page includes the following fields:

Object	Description
<ul style="list-style-type: none"> • Port 	The port number for which the configuration below applies.
<ul style="list-style-type: none"> • QoS Class 	<p>The Configuration All with available values will assign to whole ports.</p> <p>Controls the default QoS class, i.e., the QoS class for frames not classified in any other way. There is a one to one mapping between QoS class, queue and priority. A QoS class of 0 (zero) has the lowest priority.</p> <p>All means all ports will have one specific setting.</p>
<ul style="list-style-type: none"> • DP Level 	<p>The Configuration All with available values will assign to whole ports.</p> <p>Controls the default DP level, i.e., the DP level for frames not classified in any other way.</p> <p>All means all ports will have one specific setting.</p>
<ul style="list-style-type: none"> • PCP 	<p>The Configuration All with available values will assign to whole ports.</p> <p>Controls the default PCP for untagged frames.</p> <p>All means all ports will have one specific setting.</p>
<ul style="list-style-type: none"> • DEI 	<p>The Configuration All with available values will assign to whole ports.</p> <p>Controls the default DEI for untagged frames.</p> <p>All means all ports will have one specific setting.</p>

<ul style="list-style-type: none"> • Tag Class 	<p>Shows the classification mode for tagged frames on this port.</p> <ul style="list-style-type: none"> ■ Disabled: Use default QoS class and DP level for tagged frames. ■ Enabled: Use mapped versions of PCP and DEI for tagged frames. <p>Click on the mode in order to configure the mode and/or mapping.</p> <p>For more detail information, please refer to chapter 4.9.3.1.</p>
<ul style="list-style-type: none"> • DSCP Based 	<p>Click to Enable DSCP Based QoS Ingress Port Classification.</p>

Buttons



: Click to save changes.



: Click to undo any changes made locally and revert to previously saved values.

4.9.3.1 QoS Ingress Port Tag Classification

The classification modes for tagged frames are configured on this page. The QoS Ingress Port Tag Classification screen in [Figure 4-9-3](#) appears.

Port 1 ▾

QoS Ingress Port Tag Classification Port 1

Tagged Frames Settings

Tag Classification Disabled ▾

(PCP, DEI) to (QoS Class, DP Level) Mapping

PCP	DEI	QoS Class	DP Level
*	*	<All> ▾	<All> ▾
0	0	1 ▾	0 ▾
0	1	1 ▾	1 ▾
1	0	0 ▾	0 ▾
1	1	0 ▾	1 ▾
2	0	2 ▾	0 ▾
2	1	2 ▾	1 ▾
3	0	3 ▾	0 ▾
3	1	3 ▾	1 ▾
4	0	4 ▾	0 ▾
4	1	4 ▾	1 ▾
5	0	5 ▾	0 ▾
5	1	5 ▾	1 ▾
6	0	6 ▾	0 ▾
6	1	6 ▾	1 ▾
7	0	7 ▾	0 ▾
7	1	7 ▾	1 ▾

Figure 4-9-3 : QoS Ingress Port Tag Classification Page Screenshot

The page includes the following fields:

Object	Description
<ul style="list-style-type: none"> • Tag Classification 	Controls the classification mode for tagged frames on this port. <ul style="list-style-type: none"> ■ Disabled: Use default QoS class and DP level for tagged frames. ■ Enabled: Use mapped versions of PCP and DEI for tagged frames.
<ul style="list-style-type: none"> • (PCP, DEI) to (QoS class, DP level) Mapping 	The Configuration All with available values will assign to whole items. Controls the mapping of the classified (PCP, DEI) to (QoS class, DP level) values when Tag Classification is set to Enabled .

Buttons

: Click to save changes.

: Click to undo any changes made locally and revert to previously saved values.

: Return to the previous page.

4.9.4 Port Scheduler

This page provides an overview of QoS Egress Port Schedulers for all switch ports. The Port Scheduler screen in [Figure 4-9-4](#) appears.

QoS Egress Port Schedulers

Port	Mode	Weight					
		Q0	Q1	Q2	Q3	Q4	Q5
1	Strict Priority	-	-	-	-	-	-
2	Strict Priority	-	-	-	-	-	-
3	Strict Priority	-	-	-	-	-	-
4	Strict Priority	-	-	-	-	-	-
5	Strict Priority	-	-	-	-	-	-
6	Strict Priority	-	-	-	-	-	-
7	Strict Priority	-	-	-	-	-	-
8	Strict Priority	-	-	-	-	-	-
9	Strict Priority	-	-	-	-	-	-
10	Strict Priority	-	-	-	-	-	-

Figure 4-9-4: QoS Egress Port Schedule Page Screenshot

The page includes the following fields:

Object	Description
<ul style="list-style-type: none"> • Port 	The logical port for the settings contained in the same row. Click on the port number in order to configure the schedulers. For more detail, please refer to chapter 4.9.5.1.

• Mode	Shows the scheduling mode for this port.
• Q0 ~ Q5	Shows the weight for this queue and port.

4.9.5 Port Shaping

This page provides an overview of QoS Egress Port Shapers for all switch ports. The Port Shapping screen in [Figure 4-9-5](#) appears.

QoS Egress Port Shapers									
Port	Shapers								Port
	Q0	Q1	Q2	Q3	Q4	Q5	Q6	Q7	
1	disabled	disabled	disabled	disabled	disabled	disabled	disabled	disabled	disabled
2	disabled	disabled	disabled	disabled	disabled	disabled	disabled	disabled	disabled
3	disabled	disabled	disabled	disabled	disabled	disabled	disabled	disabled	disabled
4	disabled	disabled	disabled	disabled	disabled	disabled	disabled	disabled	disabled
5	disabled	disabled	disabled	disabled	disabled	disabled	disabled	disabled	disabled
6	disabled	disabled	disabled	disabled	disabled	disabled	disabled	disabled	disabled
7	disabled	disabled	disabled	disabled	disabled	disabled	disabled	disabled	disabled
8	disabled	disabled	disabled	disabled	disabled	disabled	disabled	disabled	disabled
9	disabled	disabled	disabled	disabled	disabled	disabled	disabled	disabled	disabled
10	disabled	disabled	disabled	disabled	disabled	disabled	disabled	disabled	disabled

Figure 4-9-5: QoS Egress Port Shapers Page Screenshot

The page includes the following fields:

Object	Description
• Port	The logical port for the settings contained in the same row. Click on the port number in order to configure the shapers. For more detail, please refer to chapter 4.9.5.1.
• Q0 ~Q7	Shows "disabled" or actual queue shaper rate - e.g. "800 Mbps".
• Port	Shows "disabled" or actual port shaper rate - e.g. "800 Mbps".

4.9.5.1 QoS Egress Port Schedule and Shapers

The Port Scheduler and Shapers for a specific port are configured on this page. The QoS Egress Port Schedule and Shaper screen in Figure 4-9-6 appears.

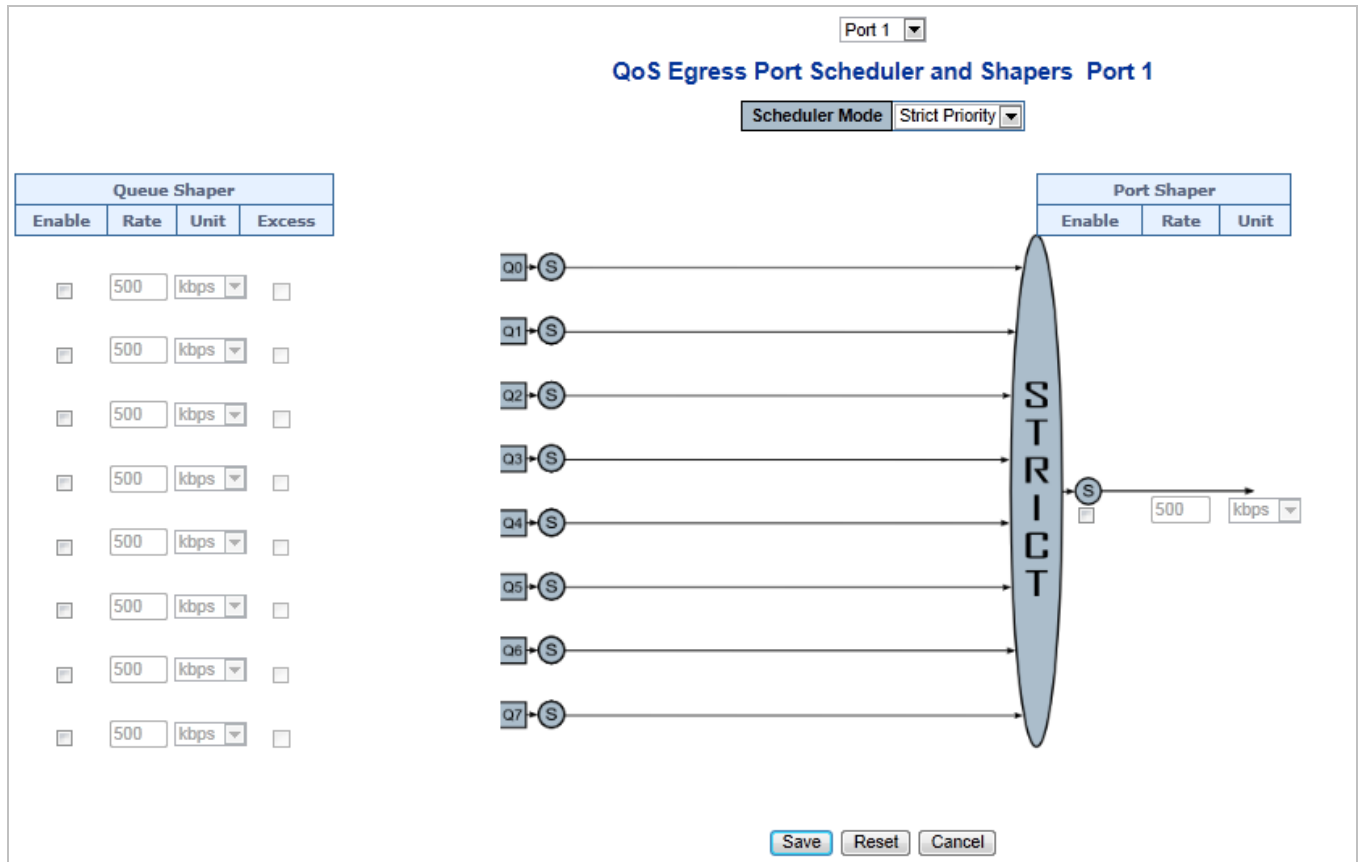

Figure 4-9-6: QoS Egress Port Schedule and Shapers Page Screenshot

The page includes the following fields:

Object	Description
<ul style="list-style-type: none"> Schedule Mode 	Controls whether the scheduler mode is "Strict Priority" or "Weighted" on this switch port.
<ul style="list-style-type: none"> Queue Shaper Enable 	Controls whether the queue shaper is enabled for this queue on this switch port.
<ul style="list-style-type: none"> Queue Shaper Rate 	Controls the rate for the queue shaper. The default value is 500. This value is restricted to 100-1000000 when the "Unit" is "kbps" , and it is restricted to 1-3300 when the "Unit" is "Mbps" .
<ul style="list-style-type: none"> Queue Shaper Unit 	Controls the unit of measure for the queue shaper rate as "kbps" or "Mbps" . The default value is "kbps" .
<ul style="list-style-type: none"> Queue Shaper Excess 	Controls whether the queue is allowed to use excess bandwidth.
<ul style="list-style-type: none"> Queue Scheduler Weight 	Controls the weight for this queue. The default value is "17" . This value is restricted to 1-100. This parameter is only shown if "Scheduler Mode" is set to "Weighted" .

<ul style="list-style-type: none"> • Queue Scheduler Percent 	Shows the weight in percent for this queue. This parameter is only shown if " Scheduler Mode " is set to " Weighted ".
<ul style="list-style-type: none"> • Port Shaper Enable 	Controls whether the port shaper is enabled for this switch port.
<ul style="list-style-type: none"> • Port Shaper Rate 	Controls the rate for the port shaper. The default value is 500. This value is restricted to 100-1000000 when the " Unit " is " kbps ", and it is restricted to 1-3300 when the " Unit " is " Mbps ".
<ul style="list-style-type: none"> • Port Shaper Unit 	Controls the unit of measure for the port shaper rate as " kbps " or " Mbps ". The default value is " kbps ".

Buttons

: Click to save changes.

: Click to undo any changes made locally and revert to previously saved values.

: Click to undo any changes made locally and return to the previous page.

4.9.6 Port Tag Remarking

This page provides an overview of QoS Egress Port Tag Remarking for all switch ports. The Port Tag Remarking screen in [Figure 4-9-7](#) appears.

Port	Mode
1	Classified
2	Classified
3	Classified
4	Classified
5	Classified
6	Classified
7	Classified
8	Classified
9	Classified
10	Classified

Figure 4-9-7: QoS Egress Port Tag Remarking Page Screenshot

The page includes the following fields:

Object	Description
<ul style="list-style-type: none"> • Port 	The logical port for the settings contained in the same row. Click on the port number in order to configure tag remarking. For more detail, please refer to chapter 4.9.6.1.
<ul style="list-style-type: none"> • Mode 	Shows the tag remarking mode for this port. <ul style="list-style-type: none"> ■ Classified: Use classified PCP/DEI values.

	<ul style="list-style-type: none"> ■ Default: Use default PCP/DEI values. ■ Mapped: Use mapped versions of QoS class and DP level.
--	--

4.9.6.1 QoS Egress Port Tag Remarking

The QoS Egress Port Tag Remarking for a specific port are configured on this page. The QoS Egress Port Tag Remarking screen in [Figure 4-9-8](#) appears.



Figure 4-9-8: QoS Egress Port Tag Remarking Page Screenshot

The page includes the following fields:

Object	Description
<ul style="list-style-type: none"> • Mode 	Controls the tag remarking mode for this port. <ul style="list-style-type: none"> ■ Classified: Use classified PCP/DEI values. ■ Default: Use default PCP/DEI values. ■ Mapped: Use mapped versions of QoS class and DP level.
<ul style="list-style-type: none"> • PCP/DEI Configuration 	Controls the default PCP and DEI values used when the mode is set to Default .
<ul style="list-style-type: none"> • (QoS class, DP level) to (PCP, DEI) Mapping 	Controls the mapping of the classified (QoS class, DP level) to (PCP, DEI) values when the mode is set to Mapped .

Buttons

Save: Click to save changes.

Reset: Click to undo any changes made locally and revert to previously saved values.

Cancel: Click to undo any changes made locally and return to the previous page.

4.9.7 Port DSCP

This page allows you to configure the basic QoS Port DSCP Configuration settings for all switch ports. The Port DSCP screen in Figure 4-9-9 appears.

QoS Port DSCP Configuration

Port	Ingress		Egress
	Translate	Classify	Rewrite
*	<input type="checkbox"/>	<All> ▼	<All> ▼
1	<input type="checkbox"/>	Disable ▼	Disable ▼
2	<input type="checkbox"/>	Disable ▼	Disable ▼
3	<input type="checkbox"/>	Disable ▼	Disable ▼
4	<input type="checkbox"/>	Disable ▼	Disable ▼
5	<input type="checkbox"/>	Disable ▼	Disable ▼
6	<input type="checkbox"/>	Disable ▼	Disable ▼
7	<input type="checkbox"/>	Disable ▼	Disable ▼
8	<input type="checkbox"/>	Disable ▼	Disable ▼
9	<input type="checkbox"/>	Disable ▼	Disable ▼
10	<input type="checkbox"/>	Disable ▼	Disable ▼

Figure 4-9-9 : QoS Port DSCP Configuration Page Screenshot

The page includes the following fields:

Object	Description
<ul style="list-style-type: none"> • Port 	The Port column shows the list of ports for which you can configure dscp ingress and egress settings.
<ul style="list-style-type: none"> • Ingress 	<p>In Ingress settings you can change ingress translation and classification settings for individual ports.</p> <p>There are two configuration parameters available in Ingress:</p> <ul style="list-style-type: none"> ■ Translate ■ Classify
<ul style="list-style-type: none"> • Translate 	To Enable the Ingress Translation click the checkbox. * means to select all ports of Industrial Managed Switch.
<ul style="list-style-type: none"> • Classify 	<p>The Configuration All with available options will assign to whole ports.</p> <p>Classification for a port has 4 different values. All means all ports will have one specific setting.</p> <ul style="list-style-type: none"> ■ Disable: No Ingress DSCP Classification. ■ DSCP=0: Classify if incoming (or translated if enabled) DSCP is 0. ■ Selected: Classify only selected DSCP for which classification is enabled as specified in DSCP Translation window for the specific DSCP.

	<ul style="list-style-type: none"> ■ All: Classify all DSCP.
<ul style="list-style-type: none"> • Egress 	<p>The Configuration All with available options will assign to whole ports.</p> <p>Port Egress Rewriting can be one of –. All means all ports will have one specific setting.</p> <ul style="list-style-type: none"> ■ Disable: No Egress rewrite. ■ Enable: Rewrite enabled without remapping. ■ Remap DP Unaware: DSCP from analyzer is remapped and frame is remarked with remapped DSCP value. The remapped DSCP value is always taken from the 'DSCP Translation->Egress Remap DP0' table. ■ Remap DP Aware: DSCP from analyzer is remapped and frame is remarked with remapped DSCP value. Depending on the DP level of the frame, the remapped DSCP value is either taken from the 'DSCP Translation->Egress Remap DP0' table or from the 'DSCP Translation->Egress Remap DP1' table.

Buttons

: Click to save changes.

: Click to undo any changes made locally and revert to previously saved values.

4.9.8 DSCP-Based QoS

This page allows you to configure the basic QoS DSCP based QoS Ingress Classification settings for all switches. The DSCP-Based QoS screen in [Figure 4-9-10](#) appears.

DSCP-Based QoS Ingress Classification

DSCP	Trust	QoS Class	DPL
*	<input type="checkbox"/>	<All> ▼	<All> ▼
0 (BE)	<input type="checkbox"/>	0 ▼	0 ▼
1	<input type="checkbox"/>	0 ▼	0 ▼
2	<input type="checkbox"/>	0 ▼	0 ▼
3	<input type="checkbox"/>	0 ▼	0 ▼
4	<input type="checkbox"/>	0 ▼	0 ▼
5	<input type="checkbox"/>	0 ▼	0 ▼
6	<input type="checkbox"/>	0 ▼	0 ▼
7	<input type="checkbox"/>	0 ▼	0 ▼
8 (CS1)	<input type="checkbox"/>	0 ▼	0 ▼
9	<input type="checkbox"/>	0 ▼	0 ▼
10 (AF11)	<input type="checkbox"/>	0 ▼	0 ▼
11	<input type="checkbox"/>	0 ▼	0 ▼
12 (AF12)	<input type="checkbox"/>	0 ▼	0 ▼
13	<input type="checkbox"/>	0 ▼	0 ▼
14 (AF13)	<input type="checkbox"/>	0 ▼	0 ▼
60	<input type="checkbox"/>	0 ▼	0 ▼
61	<input type="checkbox"/>	0 ▼	0 ▼
62	<input type="checkbox"/>	0 ▼	0 ▼
63	<input type="checkbox"/>	0 ▼	0 ▼

Figure 4-9-10: DSCP-Based QoS Ingress Classification Page Screenshot

The page includes the following fields:

Object	Description
<ul style="list-style-type: none"> DSCP 	Maximum number of supported DSCP values are 63.
<ul style="list-style-type: none"> Trust 	Click to check if the DSCP value is trusted. * means to select all ports of Industrial Managed Switch.

<ul style="list-style-type: none"> • QoS Class 	The Configuration All with available values will assign to whole DSCP values. QoS Class value can be any of (0-7)
<ul style="list-style-type: none"> • DPL 	The Configuration All with available values will assign to whole DSCP values. Drop Precedence Level (0-1)

Buttons



: Click to save changes.



: Click to undo any changes made locally and revert to previously saved values.

4.9.9 DSCP Translation

This page allows you to configure the basic QoS DSCP Translation settings for all switches. DSCP translation can be done in Ingress or Egress. The DSCP Translation screen in [Figure 4-9-11](#) appears.

DSCP Translation

DSCP	Ingress		Egress			
	Translate	Classify	Remap DP0	Remap DP1	Remap DP2	Remap DP3
*	<All> <input type="checkbox"/>	<input type="checkbox"/>	<All> <input type="checkbox"/>	<All> <input type="checkbox"/>	<All> <input type="checkbox"/>	<All> <input type="checkbox"/>
0 (BE)	0 (BE) <input type="checkbox"/>	<input type="checkbox"/>	0 (BE) <input type="checkbox"/>	0 (BE) <input type="checkbox"/>	0 (BE) <input type="checkbox"/>	0 (BE) <input type="checkbox"/>
1	1 <input type="checkbox"/>	<input type="checkbox"/>	1 <input type="checkbox"/>	1 <input type="checkbox"/>	1 <input type="checkbox"/>	1 <input type="checkbox"/>
2	2 <input type="checkbox"/>	<input type="checkbox"/>	2 <input type="checkbox"/>	2 <input type="checkbox"/>	2 <input type="checkbox"/>	2 <input type="checkbox"/>
3	3 <input type="checkbox"/>	<input type="checkbox"/>	3 <input type="checkbox"/>	3 <input type="checkbox"/>	3 <input type="checkbox"/>	3 <input type="checkbox"/>
4	4 <input type="checkbox"/>	<input type="checkbox"/>	4 <input type="checkbox"/>	4 <input type="checkbox"/>	4 <input type="checkbox"/>	4 <input type="checkbox"/>
5	5 <input type="checkbox"/>	<input type="checkbox"/>	5 <input type="checkbox"/>	5 <input type="checkbox"/>	5 <input type="checkbox"/>	5 <input type="checkbox"/>
6	6 <input type="checkbox"/>	<input type="checkbox"/>	6 <input type="checkbox"/>	6 <input type="checkbox"/>	6 <input type="checkbox"/>	6 <input type="checkbox"/>
7	7 <input type="checkbox"/>	<input type="checkbox"/>	7 <input type="checkbox"/>	7 <input type="checkbox"/>	7 <input type="checkbox"/>	7 <input type="checkbox"/>
8 (CS1)	8 (CS1) <input type="checkbox"/>	<input type="checkbox"/>	8 (CS1) <input type="checkbox"/>	8 (CS1) <input type="checkbox"/>	8 (CS1) <input type="checkbox"/>	8 (CS1) <input type="checkbox"/>
9	9 <input type="checkbox"/>	<input type="checkbox"/>	9 <input type="checkbox"/>	9 <input type="checkbox"/>	9 <input type="checkbox"/>	9 <input type="checkbox"/>
10 (AF11)	10 (AF11) <input type="checkbox"/>	<input type="checkbox"/>	10 (AF11) <input type="checkbox"/>	10 (AF11) <input type="checkbox"/>	10 (AF11) <input type="checkbox"/>	10 (AF11) <input type="checkbox"/>
11	11 <input type="checkbox"/>	<input type="checkbox"/>	11 <input type="checkbox"/>	11 <input type="checkbox"/>	11 <input type="checkbox"/>	11 <input type="checkbox"/>
12 (AF12)	12 (AF12) <input type="checkbox"/>	<input type="checkbox"/>	12 (AF12) <input type="checkbox"/>	12 (AF12) <input type="checkbox"/>	12 (AF12) <input type="checkbox"/>	12 (AF12) <input type="checkbox"/>
13	13 <input type="checkbox"/>	<input type="checkbox"/>	13 <input type="checkbox"/>	13 <input type="checkbox"/>	13 <input type="checkbox"/>	13 <input type="checkbox"/>
14 (AF13)	14 (AF13) <input type="checkbox"/>	<input type="checkbox"/>	14 (AF13) <input type="checkbox"/>	14 (AF13) <input type="checkbox"/>	14 (AF13) <input type="checkbox"/>	14 (AF13) <input type="checkbox"/>
15	15 <input type="checkbox"/>	<input type="checkbox"/>	15 <input type="checkbox"/>	15 <input type="checkbox"/>	15 <input type="checkbox"/>	15 <input type="checkbox"/>
16 (CS2)	16 (CS2) <input type="checkbox"/>	<input type="checkbox"/>	16 (CS2) <input type="checkbox"/>	16 (CS2) <input type="checkbox"/>	16 (CS2) <input type="checkbox"/>	16 (CS2) <input type="checkbox"/>
17	17 <input type="checkbox"/>	<input type="checkbox"/>	17 <input type="checkbox"/>	17 <input type="checkbox"/>	17 <input type="checkbox"/>	17 <input type="checkbox"/>

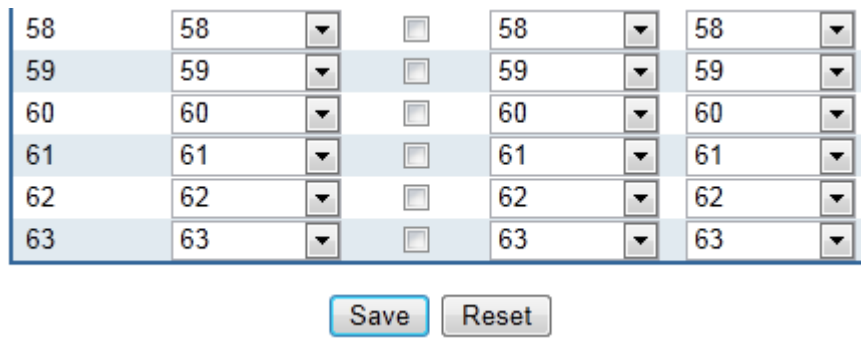

Figure 4-9-11: DSCP Translation Page Screenshot

The page includes the following fields:

Object	Description
• DSCP	Maximum numbers of supported DSCP values are 64 and valid DSCP value ranges from 0 to 63.
• Ingress	Ingress side DSCP can be first translated to new DSCP before using the DSCP for QoS class and DPL map. There are two configuration parameters for DSCP Translation – <ul style="list-style-type: none"> ■ Translate ■ Classify
• Translate	The Configuration All with available values will assign to whole DSCP values. DSCP at Ingress side can be translated to any of (0-63) DSCP values.
• Classify	Click to enable Classification at Ingress side.
• Egress	There are the following configurable parameters for Egress side – <ul style="list-style-type: none"> ■ Remap DP0 Controls the remapping for frames with DP level 0. ■ Remap DP1 Controls the remapping for frames with DP level 1.
• Remap DP0	The Configuration All with available values will assign to whole DSCP values. Select the DSCP value from select menu to which you want to remap. DSCP value ranges form 0 to 63.
• Remap DP1	The Configuration All with available values will assign to whole DSCP values. Select the DSCP value from select menu to which you want to remap. DSCP value ranges form 0 to 63.

Buttons

Save: Click to save changes.

Reset: Click to undo any changes made locally and revert to previously saved values.

4.9.10 DSCP Classification

This page allows you to map DSCP value to a QoS Class and DPL value. The DSCP Classification screen in [Figure 4-9-12](#) appears.

DSCP Classification

QoS Class	DPL	DSCP	
*	*	<All>	▼
0	0	0 (BE)	▼
0	1	0 (BE)	▼
1	0	0 (BE)	▼
1	1	0 (BE)	▼
2	0	0 (BE)	▼
2	1	0 (BE)	▼
3	0	0 (BE)	▼
3	1	0 (BE)	▼
4	0	0 (BE)	▼
4	1	0 (BE)	▼
5	0	0 (BE)	▼
5	1	0 (BE)	▼
6	0	0 (BE)	▼
6	1	0 (BE)	▼
7	0	0 (BE)	▼
7	1	0 (BE)	▼

Figure 4-9-12: DSCP Classification Page Screenshot

The page includes the following fields:

Object	Description
<ul style="list-style-type: none"> QoS Class 	Available QoS Class value ranges from 0 to 7. QoS Class (0-7) can be mapped to followed parameters.
<ul style="list-style-type: none"> DPL 	Drop Precedence Level (0-1) can be configured for all available QoS Classes.
<ul style="list-style-type: none"> DSCP 	The Configuration All with available values will assign to whole QoS Class. Select DSCP value (0-63) from DSCP menu to map DSCP to corresponding QoS Class and DPL value

Buttons

: Click to save changes.

: Click to undo any changes made locally and revert to previously saved values.

4.9.11 QoS Control List

This page shows the QoS Control List(QCL), which is made up of the QCEs. Each row describes a QCE that is defined. The maximum number of QCEs is 256 on each switch.

Click on the lowest plus sign to add a new QCE to the list.

The QoS Control List screen in [Figure 4-9-13](#) appears.







QoS Control List Configuration

QCE#	Port	Frame Type	SMAC	DMAC	VID	PCP	DEI	Action		
								Class	DPL	DSCP
+										

Figure 4-9-13: QoS Control List Configuration Page Screenshot

The page includes the following fields:

Object	Description
• QCE#	Indicates the index of QCE.
• Port	Indicates the list of ports configured with the QCE.
26. Frame Type	Indicates the type of frame to look for incoming frames. Possible frame types are: <ul style="list-style-type: none"> ■ Any: The QCE will match all frame type. ■ Ethernet: Only Ethernet frames (with Ether Type 0x600-0xFFFF) are allowed. ■ LLC: Only (LLC) frames are allowed. ■ SNAP: Only (SNAP) frames are allowed. ■ IPv4: The QCE will match only IPV4 frames. ■ IPv6: The QCE will match only IPV6 frames.
27. SMAC	Displays the OUI field of Source MAC address, i.e. first three octet (byte) of MAC address.
28. DMAC	Specify the type of Destination MAC addresses for incoming frame. Possible values are: <ul style="list-style-type: none"> ■ Any: All types of Destination MAC addresses are allowed. ■ Unicast: Only Unicast MAC addresses are allowed. ■ Multicast: Only Multicast MAC addresses are allowed. ■ Broadcast: Only Broadcast MAC addresses are allowed. The default value is 'Any'.
• VID	Indicates (VLAN ID), either a specific VID or range of VIDs. VID can be in the range 1-4095 or 'Any'
• PCP	Priority Code Point: Valid value PCP are specific(0, 1, 2, 3, 4, 5, 6, 7) or

	range(0-1, 2-3, 4-5, 6-7, 0-3, 4-7) or 'Any'.
<ul style="list-style-type: none"> • DEI 	Drop Eligible Indicator: Valid value of DEI can be any of values between 0, 1 or 'Any'.
<ul style="list-style-type: none"> • Action 	<p>Indicates the classification action taken on ingress frame if parameters configured are matched with the frame's content.</p> <p>There are three action fields: Class, DPL and DSCP.</p> <ul style="list-style-type: none"> ■ Class: Classified QoS Class; if a frame matches the QCE it will be put in the queue. ■ DPL: Drop Precedence Level; if a frame matches the QCE then DP level will set to value displayed under DPL column. ■ DSCP: If a frame matches the QCE then DSCP will be classified with the value displayed under DSCP column.
<ul style="list-style-type: none"> • Modification Buttons 	<p>You can modify each QCE in the table using the following buttons:</p> <ul style="list-style-type: none"> : Inserts a new QCE before the current row. : Edits the QCE. : Moves the QCE up the list. : Moves the QCE down the list. : Deletes the QCE. : The lowest plus sign adds a new entry at the bottom of the list of QCL.

4.9.11.1 QoS Control Entry Configuration

The QCE Configuration screen in [Figure 4-9-14](#) appears.

QCE Configuration

Port Members									
1	2	3	4	5	6	7	8	9	10
<input checked="" type="checkbox"/>	<input checked="" type="checkbox"/>	<input checked="" type="checkbox"/>	<input checked="" type="checkbox"/>	<input checked="" type="checkbox"/>	<input checked="" type="checkbox"/>	<input checked="" type="checkbox"/>	<input checked="" type="checkbox"/>	<input checked="" type="checkbox"/>	<input checked="" type="checkbox"/>

Key Parameters

Tag	Any
VID	Any
PCP	Any
DEI	Any
SMAC	Any
DMAC Type	Any
Frame Type	Any

Action Parameters

Class	0
DPL	Default
DSCP	Default

Figure 4-9-14: QCE Configuration Page Screenshot

The page includes the following fields:

Object	Description
<ul style="list-style-type: none"> • Port Members 	<p>Check the checkbox button in case you want to make any port member of the QCL entry. By default all ports will be checked</p>
<ul style="list-style-type: none"> • Key Parameters 	<p>Key configuration is described as below:</p> <ul style="list-style-type: none"> ■ Tag Value of Tag field can be 'Any', 'Untag' or 'Tag'. ■ VID Valid value of VLAN ID can be any value in the range 1-4095 or 'Any'; user can enter either a specific value or a range of VIDs. ■ PCP Priority Code Point: Valid value PCP are specific(0, 1, 2, 3, 4, 5, 6, 7) or range(0-1, 2-3, 4-5, 6-7, 0-3, 4-7) or 'Any'. ■ DEI Drop Eligible Indicator: Valid value of DEI can be any of values between 0, 1 or 'Any'. ■ SMAC Source MAC address: 24 MS bits (OUI) or 'Any'. ■ DMAC Type Destination MAC type: possible values are unicast(UC), multicast(MC), broadcast(BC) or 'Any'. ■ Frame Type Frame Type can have any of the following values:

	<ol style="list-style-type: none"> 1. Any 2. Ethernet 3. LLC 4. SNAP 5. IPv4 6. IPv6 <p>Note: All frame types are explained below.</p>
• Any	Allow all types of frames.
• Ethernet	Ethernet Type Valid ethernet type can have value within 0x600-0xFFFF or 'Any' but excluding 0x800(IPv4) and 0x86DD(IPv6), default value is 'Any'.
• LLC	<ul style="list-style-type: none"> ■ SSAP Address Valid SSAP(Source Service Access Point) can vary from 0x00 to 0xFF or 'Any', the default value is 'Any' ■ DSAP Address Valid DSAP(Destination Service Access Point) can vary from 0x00 to 0xFF or 'Any', the default value is 'Any' ■ Control Address Valid Control Address can vary from 0x00 to 0xFF or 'Any', the default value is 'Any'
• SNAP	PID Valid PID(a.k.a ethernet type) can have value within 0x00-0xFFFF or 'Any', default value is 'Any'
• IPv4	<ul style="list-style-type: none"> ■ Protocol IP protocol number: (0-255, TCP or UDP) or 'Any' ■ Source IP Specific Source IP address in value/mask format or 'Any'. IP and Mask are in the format x.y.z.w where x, y, z, and w are decimal numbers between 0 and 255. When Mask is converted to a 32-bit binary string and read from left to right, all bits following the first zero must also be zero ■ DSCP Diffserv Code Point value(DSCP): It can be specific value, range of value or 'Any'. DSCP values are in the range 0-63 including BE, CS1-CS7, EF or AF11-AF43 ■ IP Fragment IPv4 frame fragmented option: yes no any ■ Sport Source TCP/UDP port:(0-65535) or 'Any', specific or port range applicable for IP protocol UDP/TCP ■ Dport Destination TCP/UDP port:(0-65535) or 'Any', specific or port range applicable for IP protocol UDP/TCP
29. IPv6	<ul style="list-style-type: none"> ■ Protocol IP protocol number: (0-255, TCP or UDP) or 'Any' ■ Source IP IPv6 source address: (a.b.c.d) or 'Any', 32 LS bits ■ DSCP Diffserv Code Point value(DSCP): It can be specific value, range of value or 'Any'. DSCP values are in the range 0-63 including BE, CS1-CS7, EF or AF11-AF43 ■ Sport Source TCP/UDP port:(0-65535) or 'Any', specific or port range applicable for IP protocol UDP/TCP ■ Dport Destination TCP/UDP port:(0-65535) or 'Any', specific or port range applicable for IP protocol UDP/TCP

30. Action Parameters	<ul style="list-style-type: none"> ■ Class QoS class: (0-7) or 'Default'. ■ DP Valid Drop Precedence Level can be (0-1) or 'Default'. ■ DSCP Valid DSCP value can be (0-63, BE, CS1-CS7, EF or AF11-AF43) or 'Default'. <p>'Default' means that the default classified value is not modified by this QCE.</p>
------------------------------	---

Buttons

- Save**: Click to save the configuration and move to main QCL page
- Reset**: Click to undo any changes made locally and revert to previously saved values
- Cancel**: Return to the previous page without saving the configuration change

4.9.12 QoS Status

This page shows the QCL status by different QCL users. Each row describes the QCE that is defined. It is a conflict if a specific QCE is not applied to the hardware due to hardware limitations. The maximum number of QCEs is **256** on each switch. The QoS Control List Status screen in [Figure 4-9-15](#) appears.

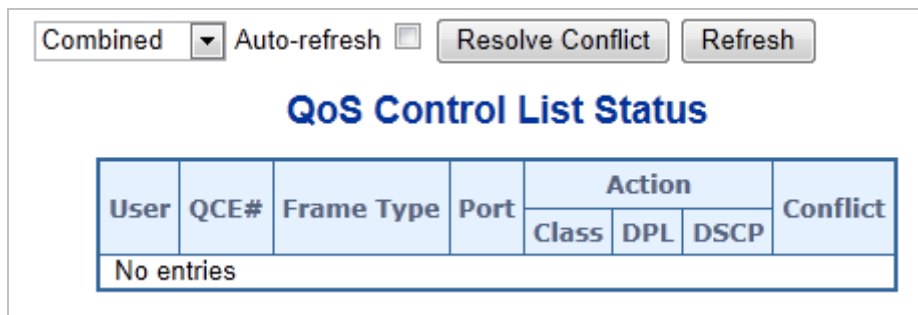

Figure 4-9-15: QoS Control List Status Page Screenshot

The page includes the following fields:

Object	Description
• User	Indicates the QCL user.
• QCE#	Indicates the index of QCE.
31. Frame Type	<p>Indicates the type of frame to look for incoming frames. Possible frame types are:</p> <ul style="list-style-type: none"> ■ Any: The QCE will match all frame type. ■ Ethernet: Only Ethernet frames (with Ether Type 0x600-0xFFFF) are allowed. ■ LLC: Only (LLC) frames are allowed. ■ SNAP: Only (SNAP) frames are allowed.

	<ul style="list-style-type: none"> ■ IPv4: The QCE will match only IPV4 frames. ■ IPv6: The QCE will match only IPV6 frames.
32. Port	Indicates the list of ports configured with the QCE
33. Action	<p>Indicates the classification action taken on ingress frame if parameters configured are matched with the frame's content.</p> <p>There are three action fields: Class, DPL and DSCP.</p> <ul style="list-style-type: none"> ■ Class: Classified QoS Class; if a frame matches the QCE it will be put in the queue. ■ DPL: Drop Precedence Level; if a frame matches the QCE then DP level will set to value displayed under DPL column. ■ DSCP: If a frame matches the QCE then DSCP will be classified with the value displayed under DSCP column.
• Conflict	Displays QCE status. It may happen that resources required to add a QCE may not available, in that case it shows conflict status as 'Yes', otherwise it is always 'No'.Please note that conflict can be resolved by releaseing the resource required by the QCE and pressing 'Refresh' button.

Buttons

: Select the QCL status from this drop down list.

Auto-refresh : Check this box to refresh the page automatically. Automatic refresh occurs every 3 seconds.

: Click to release the resources required to add QCL entry, incase conflict status for any QCL entry is 'yes'.

: Click to refresh the page immediately.

4.9.13 Storm Control Configuration

Storm control for the switch is configured on this page.

There is a unicast storm rate control, multicast storm rate control, and a broadcast storm rate control. These only affect flooded frames, i.e. frames with a (VLAN ID, DMAC) pair not present on the MAC Address table.

The configuration indicates the permitted packet rate for unicast, multicast or broadcast traffic across the switch. The Storm Control Configuration screen in [Figure 4-9-16](#) appears.

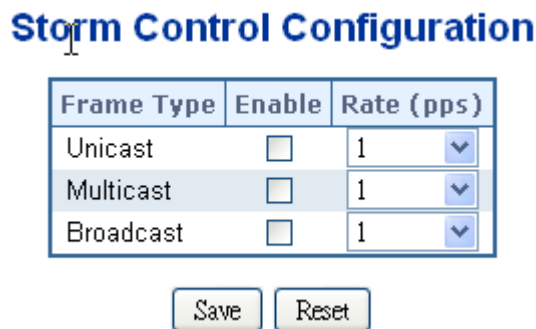

Figure 4-9-16: Storm Control Configuration Page Screenshot

The page includes the following fields:

Object	Description
<ul style="list-style-type: none"> Frame Type 	The settings in a particular row apply to the frame type listed here: <ul style="list-style-type: none"> ■ unicast ■ multicast ■ Broadcast
<ul style="list-style-type: none"> Enable 	Enable or disable the storm control status for the given frame type.
<ul style="list-style-type: none"> Rate 	The rate unit is packets per second (pps). Valid values are: 1, 2, 4, 8, 16, 32, 64, 128, 256, 512, 1K, 2K, 4K, 8K, 16K, 32K, 64K, 128K, 256K, 512K, 1024K, 2048K, 4096K, 8192K, 16384K or 32768K.

Buttons

: Click to save changes.

: Click to undo any changes made locally and revert to previously saved values.

4.9.14 QoS Statistics

This page provides statistics for the different queues for all switch ports. The QoS Statistics screen in [Figure 4-9-17](#) appears.

Queuing Counters

Auto-refresh Refresh Clear

Port	Q0		Q1		Q2		Q3		Q4		Q5		Q6		Q7		
	Rx	Tx	Rx	Tx	Rx	Tx	Rx	Tx	Rx	Tx	Rx	Tx	Rx	Tx	Rx	Tx	
1	3667	0	0	0	0	0	0	0	0	0	0	0	0	0	0	1350	0
2	0	0	0	0	0	0	0	0	0	0	0	0	0	0	0	0	0
3	0	0	0	0	0	0	0	0	0	0	0	0	0	0	0	0	0
4	0	0	0	0	0	0	0	0	0	0	0	0	0	0	0	0	0
5	0	0	0	0	0	0	0	0	0	0	0	0	0	0	0	0	0
6	0	0	0	0	0	0	0	0	0	0	0	0	0	0	0	0	0
7	0	0	0	0	0	0	0	0	0	0	0	0	0	0	0	0	0
8	0	0	0	0	0	0	0	0	0	0	0	0	0	0	0	0	0
9	0	0	0	0	0	0	0	0	0	0	0	0	0	0	0	0	0
10	0	0	0	0	0	0	0	0	0	0	0	0	0	0	0	0	0

Figure 4-9-17: Queuing Counters Page Screenshot

The page includes the following fields:

Object	Description
• Port	The logical port for the settings contained in the same row.
• Q0 ~ Q7	There are 8 QoS queues per port. Q0 is the lowest priority queue.
• Rx/Tx	The number of received and transmitted packets per queue.

Buttons

Auto-refresh : Check this box to refresh the page automatically. Automatic refresh occurs every 3 seconds.

Refresh: Click to refresh the page immediate

Clear: Clears the counters for all ports.

4.9.15 Voice VLAN Configuration

The Voice VLAN feature enables voice traffic forwarding on the Voice VLAN, then the switch can classify and schedule network traffic. It is recommended that there be two VLANs on a port - one for voice, one for data. Before connecting the IP device to the switch, the IP phone should configure the voice VLAN ID correctly. It should be configured through its own GUI. The Voice VLAN Configuration screen in [Figure 4-9-18](#) appears.

Voice VLAN Configuration

Mode	Disabled <input type="button" value="v"/>
VLAN ID	1000
Aging Time	86400 seconds
Traffic Class	7 (High) <input type="button" value="v"/>

Port Configuration

Port	Mode	Security	Discovery Protocol
*	<All> <input type="button" value="v"/>	<All> <input type="button" value="v"/>	<All> <input type="button" value="v"/>
1	Disabled <input type="button" value="v"/>	Disabled <input type="button" value="v"/>	OUI <input type="button" value="v"/>
2	Disabled <input type="button" value="v"/>	Disabled <input type="button" value="v"/>	OUI <input type="button" value="v"/>
3	Disabled <input type="button" value="v"/>	Disabled <input type="button" value="v"/>	OUI <input type="button" value="v"/>
4	Disabled <input type="button" value="v"/>	Disabled <input type="button" value="v"/>	OUI <input type="button" value="v"/>
5	Disabled <input type="button" value="v"/>	Disabled <input type="button" value="v"/>	OUI <input type="button" value="v"/>
6	Disabled <input type="button" value="v"/>	Disabled <input type="button" value="v"/>	OUI <input type="button" value="v"/>
7	Disabled <input type="button" value="v"/>	Disabled <input type="button" value="v"/>	OUI <input type="button" value="v"/>
8	Disabled <input type="button" value="v"/>	Disabled <input type="button" value="v"/>	OUI <input type="button" value="v"/>
9	Disabled <input type="button" value="v"/>	Disabled <input type="button" value="v"/>	OUI <input type="button" value="v"/>
10	Disabled <input type="button" value="v"/>	Disabled <input type="button" value="v"/>	OUI <input type="button" value="v"/>

Figure 4-9-18: Voice VLAN Configuration Page Screenshot

The page includes the following fields:

Object	Description
<ul style="list-style-type: none"> • Mode 	Indicates the Voice VLAN mode operation. We must disable MSTP feature before we enable Voice VLAN. It can avoid the conflict of ingress filter. Possible modes are: <ul style="list-style-type: none"> ■ Enabled: Enable Voice VLAN mode operation. ■ Disabled: Disable Voice VLAN mode operation.
<ul style="list-style-type: none"> • VLAN ID 	Indicates the Voice VLAN ID. It should be a unique VLAN ID in the system and cannot equal each port PVID. It is conflict configuration if the value equal management VID, MVR VID, PVID etc. The allowed range is 1 to 4095.

<ul style="list-style-type: none"> • Age Time 	<p>Indicates the Voice VLAN secure learning age time. The allowed range is 10 to 10000000 seconds. It used when security mode or auto detect mode is enabled. In other cases, it will based hardware age time. The actual age time will be situated in the [age_time; 2 * age_time] interval.</p>
<ul style="list-style-type: none"> • Traffic Class 	<p>Indicates the Voice VLAN traffic class. All traffic on Voice VLAN will apply this class.</p>
<p>34. Port Mode</p>	<p>Indicates the Voice VLAN port mode. When the port mode isn't disabled, we must disable MSTP feature before we enable Voice VLAN. It can avoid the conflict of ingress filter. Possible port modes are:</p> <ul style="list-style-type: none"> ■ Disabled: Disjoin from Voice VLAN. ■ Auto: Enable auto detect mode. It detects whether there is VoIP phone attached on the specific port and configure the Voice VLAN members automatically. ■ Forced: Forced join to Voice VLAN. ■ All means all ports will have one specific setting.
<p>35. Port Security</p>	<p>Indicates the Voice VLAN port security mode. When the function is enabled, all non-telephone MAC address in Voice VLAN will be blocked 10 seconds. Possible port modes are:</p> <ul style="list-style-type: none"> ■ Enabled: Enable Voice VLAN security mode operation. ■ Disabled: Disable Voice VLAN security mode operation. ■ All means all ports will have one specific setting.
<p>36. Port Discovery Protocol</p>	<p>Indicates the Voice VLAN port discovery protocol. It will only work when auto detect mode is enabled. We should enable LLDP feature before configuring discovery protocol to "LLDP" or "Both". Changing the discovery protocol to "OUI" or "LLDP" will restart auto detect process. Possible discovery protocols are:</p> <ul style="list-style-type: none"> ■ OUI: Detect telephony device by OUI address. ■ LLDP: Detect telephony device by LLDP. ■ Both: Both OUI and LLDP. ■ All means all ports will have one specific setting.

Buttons



: Click to save changes.



: Click to undo any changes made locally and revert to previously saved values.

4.9.16 Voice VLAN OUI Table

Configure VOICE VLAN OUI table on this page. The maximum entry number is 16. Modifying the OUI table will restart auto detection of OUI process. The Voice VLAN OUI Table screen in [Figure 4-9-19](#) appears.

Voice VLAN OUI Table

Delete	Telephony OUI	Description
<input type="checkbox"/>	00-30-4f	PLANET phones
<input type="checkbox"/>	00-03-6b	Cisco phones
<input type="checkbox"/>	00-0f-e2	H3C phones
<input type="checkbox"/>	00-60-b9	Philips and NEC AG phones
<input type="checkbox"/>	00-d0-1e	Pingtel phones
<input type="checkbox"/>	00-e0-75	Polycom phones
<input type="checkbox"/>	00-e0-bb	3Com phones
<input type="checkbox"/>	00-01-e3	Siemens AG phones

Figure 4-9-19 : Voice VLAN OUI Table Page Screenshot

The page includes the following fields:

Object	Description
<ul style="list-style-type: none"> Delete 	Check to delete the entry. It will be deleted during the next save.
<ul style="list-style-type: none"> Telephony OUI 	An telephony OUI address is a globally unique identifier assigned to a vendor by IEEE. It must be 6 characters long and the input format is "xx-xx-xx" (x is a hexadecimal digit).
<ul style="list-style-type: none"> Description 	The description of OUI address. Normaly, it descript which vendor telephony device. The allowed string length is 0 to 32.

Buttons

: Click to add a new access management entry.

: Click to save changes.

: Click to undo any changes made locally and revert to previously saved values.

4.10 Access Control Lists

ACL is an acronym for Access Control List. It is the list table of ACEs, containing access control entries that specify individual users or groups permitted or denied to specific traffic objects, such as a process or a program.

Each accessible traffic object contains an identifier to its ACL. The privileges determine whether there are specific traffic object access rights.

ACL implementations can be quite complex, for example, when the ACEs are prioritized for the various situation. In networking, the ACL refers to a list of service ports or network services that are available on a host or server, each with a list of hosts or servers permitted or denied to use the service. ACL can generally be configured to control inbound traffic, and in this context, they are similar to firewalls.

ACE is an acronym for Access Control Entry. It describes access permission associated with a particular ACE ID.

There are three ACE frame types (Ethernet Type, ARP, and IPv4) and two ACE actions (permit and deny). The ACE also contains many detailed, different parameter options that are available for individual application.

4.10.1 Access Control List Status

This page shows the ACL status by different ACL users. Each row describes the ACE that is defined. It is a conflict if a specific ACE is not applied to the hardware due to hardware limitations. The maximum number of ACEs is **256** on each switch. The Voice VLAN OUI Table screen in [Figure 4-10-1](#) appears.

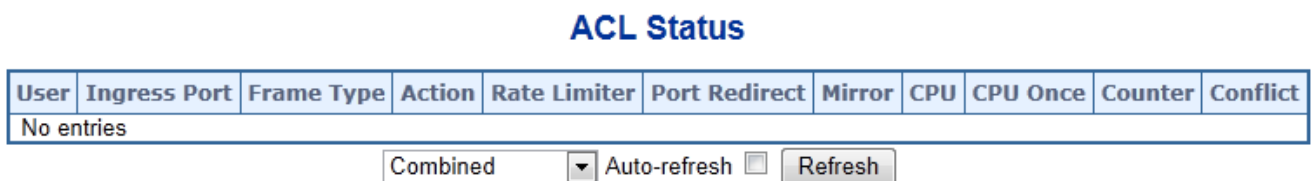

Figure 4-10-1: ACL Status Page Screenshot

The page includes the following fields:

Object	Description
37. User	Indicates the ACL user.
38. Ingress Port	Indicates the ingress port of the ACE. Possible values are: <ul style="list-style-type: none"> ■ All: The ACE will match all ingress port. ■ Port: The ACE will match a specific ingress port.
39. Frame Type	Indicates the frame type of the ACE. Possible values are: <ul style="list-style-type: none"> ■ Any: The ACE will match any frame type. ■ EType: The ACE will match Ethernet Type frames. Note that an Ethernet Type based ACE will not get matched by IP and ARP frames.

	<ul style="list-style-type: none"> ■ ARP: The ACE will match ARP/RARP frames. ■ IPv4: The ACE will match all IPv4 frames. ■ IPv4/ICMP: The ACE will match IPv4 frames with ICMP protocol. ■ IPv4/UDP: The ACE will match IPv4 frames with UDP protocol. ■ IPv4/TCP: The ACE will match IPv4 frames with TCP protocol. ■ IPv4/Other: The ACE will match IPv4 frames, which are not ICMP/UDP/TCP. ■ IPv6: The ACE will match all IPv6 standard frames.
40. Action	<p>Indicates the forwarding action of the ACE.</p> <ul style="list-style-type: none"> ■ Permit: Frames matching the ACE may be forwarded and learned. ■ Deny: Frames matching the ACE are dropped.
41. Rate Limiter	<p>Indicates the rate limiter number of the ACE. The allowed range is 1 to 16. When Disabled is displayed, the rate limiter operation is disabled.</p>
42. Port Redirect	<p>Indicates the port redirect operation of the ACE. Frames matching the ACE are redirected to the port number.</p> <p>The allowed values are Disabled or a specific port number. When Disabled is displayed, the port redirect operation is disabled.</p>
43. Mirror	<p>Specify the mirror operation of this port. The allowed values are:</p> <ul style="list-style-type: none"> ■ Enabled: Frames received on the port are mirrored. ■ Disabled: Frames received on the port are not mirrored. <p>The default value is "Disabled".</p>
44. CPU	<p>Forward packet that matched the specific ACE to CPU.</p>
45. CPU Once	<p>Forward first packet that matched the specific ACE to CPU.</p>
46. Counter	<p>The counter indicates the number of times the ACE was hit by a frame.</p>
47. Conflict	<p>Indicates the hardware status of the specific ACE. The specific ACE is not applied to the hardware due to hardware limitations.</p>

Buttons

: Select the ACL status from this drop down list.

Auto-refresh : Check this box to refresh the page automatically. Automatic refresh occurs every 3 seconds.

: Click to refresh the page immediately.

4.10.2 Access Control List Configuration

This page shows the Access Control List (ACL), which is made up of the ACEs defined on this switch. Each row describes the ACE that is defined. The maximum number of ACEs is **256** on each switch.

Click on the lowest plus sign to add a new ACE to the list. The reserved ACEs used for internal protocol, cannot be edited or deleted, the order sequence cannot be changed and the priority is highest.

The Access Control List Configuration screen in [Figure 4-10-2](#) appears.

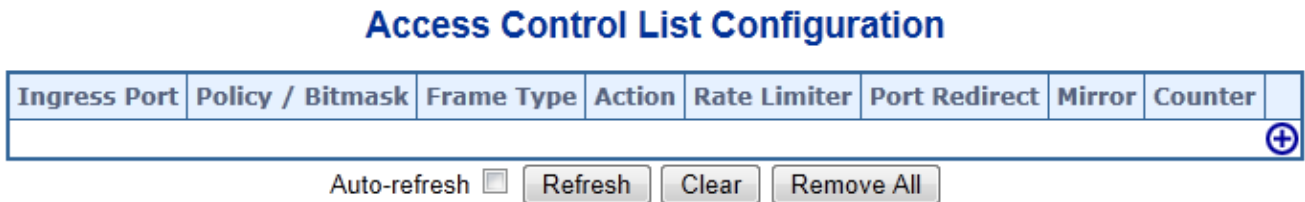







Figure 4-10-2: Access Control List Configuration Page Screenshot

The page includes the following fields:

Object	Description
48. Ingress Port	Indicates the ingress port of the ACE. Possible values are: <ul style="list-style-type: none"> ■ All: The ACE will match all ingress port. ■ Port: The ACE will match a specific ingress port.
49. Policy / Bitmask	Indicates the policy number and bitmask of the ACE.
50. Frame Type	Indicates the frame type of the ACE. Possible values are: <ul style="list-style-type: none"> ■ Any: The ACE will match any frame type. ■ EType: The ACE will match Ethernet Type frames. Note that an Ethernet Type based ACE will not get matched by IP and ARP frames. ■ ARP: The ACE will match ARP/RARP frames. ■ IPv4: The ACE will match all IPv4 frames. ■ IPv4/ICMP: The ACE will match IPv4 frames with ICMP protocol. ■ IPv4/UDP: The ACE will match IPv4 frames with UDP protocol. ■ IPv4/TCP: The ACE will match IPv4 frames with TCP protocol. ■ IPv4/Other: The ACE will match IPv4 frames, which are not ICMP/UDP/TCP. ■ IPv6: The ACE will match all IPv6 standard frames.
51. Action	Indicates the forwarding action of the ACE. <ul style="list-style-type: none"> ■ Permit: Frames matching the ACE may be forwarded and learned. ■ Deny: Frames matching the ACE are dropped.
• Rate Limiter	Indicates the rate limiter number of the ACE. The allowed range is 1 to 16. When Disabled is displayed, the rate limiter operation is disabled.

<ul style="list-style-type: none"> • Port Redirect 	<p>Indicates the port redirect operation of the ACE. Frames matching the ACE are redirected to the port number. The allowed values are Disabled or a specific port number. When Disabled is displayed, the port redirect operation is disabled.</p>
<ul style="list-style-type: none"> • Mirror 	<p>Specify the mirror operation of this port. Frames matching the ACE are mirrored to the destination mirror port. The allowed values are:</p> <ul style="list-style-type: none"> ■ Enabled: Frames received on the port are mirrored. ■ Disabled: Frames received on the port are not mirrored. <p>The default value is "Disabled".v</p>
<ul style="list-style-type: none"> • Counter 	<p>The counter indicates the number of times the ACE was hit by a frame.</p>
<ul style="list-style-type: none"> • Modification Buttons 	<p>You can modify each ACE (Access Control Entry) in the table using the following buttons:</p> <ul style="list-style-type: none"> : Inserts a new ACE before the current row. : Edits the ACE row. : Moves the ACE up the list. : Moves the ACE down the list. : Deletes the ACE. : The lowest plus sign adds a new entry at the bottom of the ACE listings.

Buttons

Auto-refresh : Check this box to refresh the page automatically. Automatic refresh occurs every 3 seconds.

: Click to refresh the page immediately.

: Click to clear the counters.

: Click to remove all ACEs.

4.10.3 ACE Configuration

Configure an ACE (Access Control Entry) on this page.

An ACE consists of several parameters. These parameters vary according to the frame type that you select. First select the ingress port for the ACE, and then select the frame type. Different parameter options are displayed depending on the frame type selected.

A frame that hits this ACE matches the configuration that is defined here. The ACE Configuration screen in [Figure 4-10-3](#) appears.

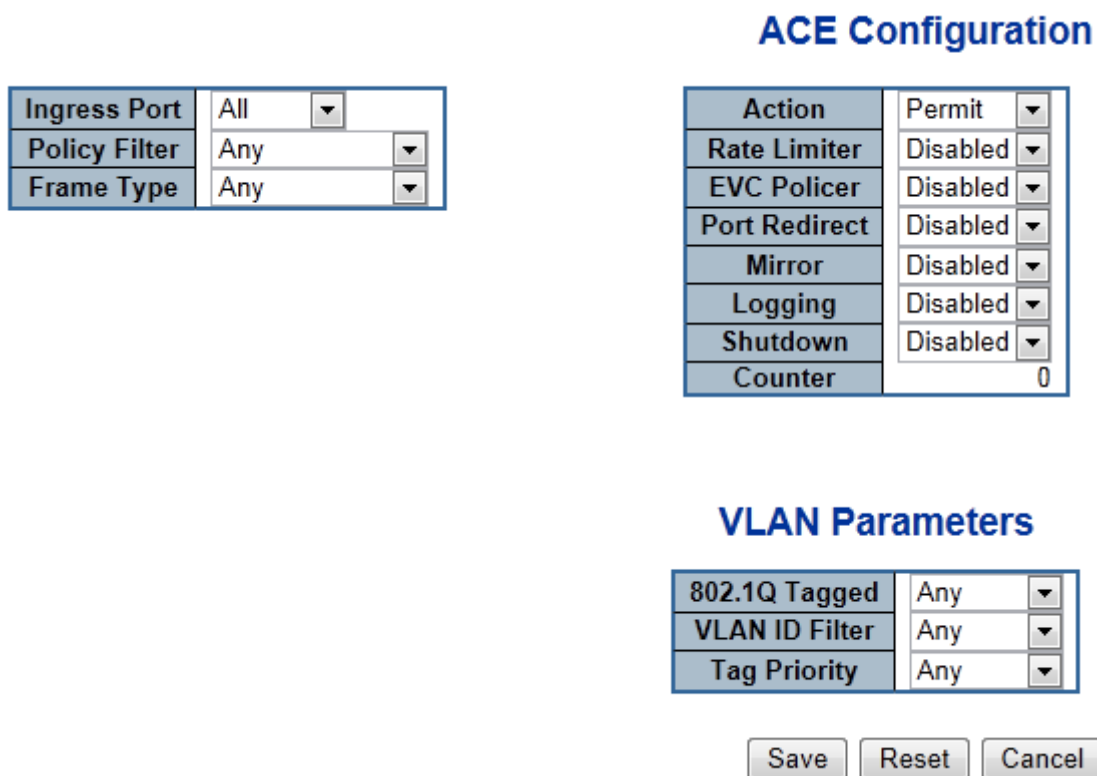

Figure 4-10-3: ACE Configuration Page Screenshot

The page includes the following fields:

Object	Description
<ul style="list-style-type: none"> Ingress Port 	<p>Select the ingress port for which this ACE applies.</p> <p>All: The ACE applies to all port.</p> <p>Portn: The ACE applies to this port number, where n is the number of the switch port.</p>
<ul style="list-style-type: none"> Policy Filter 	<p>Specify the policy number filter for this ACE.</p> <p>Any: No policy filter is specified. (policy filter status is "don't-care".)</p> <p>Specific: If you want to filter a specific policy with this ACE, choose this value. Two field for entering an policy value and bitmask appears.</p>

• Policy Value	When " Specific " is selected for the policy filter, you can enter a specific policy value. The allowed range is 0 to 255 .
• Policy Bitmask	When " Specific " is selected for the policy filter, you can enter a specific policy bitmask. The allowed range is 0x0 to 0xff .
• Frame Type	Select the frame type for this ACE. These frame types are mutually exclusive. Any : Any frame can match this ACE. Ethernet Type : Only Ethernet Type frames can match this ACE. The IEEE 802.3 describes the value of Length/Type Field specifications to be greater than or equal to 1536 decimal (equal to 0600 hexadecimal). ARP : Only ARP frames can match this ACE. Notice the ARP frames won't match the ACE with ethernet type. IPv4 : Only IPv4 frames can match this ACE. Notice the IPv4 frames won't match the ACE with ethernet type.
• Action	Specify the action to take with a frame that hits this ACE. Permit : The frame that hits this ACE is granted permission for the ACE operation. Deny : The frame that hits this ACE is dropped.
• Rate Limiter	Specify the rate limiter in number of base units. The allowed range is 1 to 16. Disabled indicates that the rate limiter operation is disabled.
• EVC Policer	Select whether EVC policer is enabled or disabled. The default value is " Disabled ".
• EVC Policer ID	Select which EVC policer ID to apply on this ACE. The allowed values are Disabled or the values 1 through 128.
• Port Redirect	Frames that hit the ACE are redirected to the port number specified here. The allowed range is the same as the switch port number range. Disabled indicates that the port redirect operation is disabled.
• Mirror	Specify the mirror operation of this port. The allowed values are: Enabled : Frames received on the port are mirrored. Disabled : Frames received on the port are not mirrored. The default value is "Disabled".
• Logging	Specify the logging operation of the ACE. The allowed values are: Enabled : Frames matching the ACE are stored in the System Log. Disabled : Frames matching the ACE are not logged. Please note that the System Log memory size and logging rate is limited.
• Shutdown	Specify the port shut down operation of the ACE. The allowed values are: Enabled : If a frame matches the ACE, the ingress port will be disabled. Disabled : Port shut down is disabled for the ACE.
• Counter	The counter indicates the number of times the ACE was hit by a frame.

■ MAC Parameters

Object	Description
<ul style="list-style-type: none"> • SMAC Filter 	<p>(Only displayed when the frame type is Ethernet Type or ARP.)</p> <p>Specify the source MAC filter for this ACE.</p> <p>Any: No SMAC filter is specified. (SMAC filter status is "don't-care".)</p> <p>Specific: If you want to filter a specific source MAC address with this ACE, choose this value. A field for entering an SMAC value appears.</p>
<ul style="list-style-type: none"> • SMAC Value 	<p>When "Specific" is selected for the SMAC filter, you can enter a specific source MAC address. The legal format is "xx-xx-xx-xx-xx-xx". A frame that hits this ACE matches this SMAC value.</p>
<ul style="list-style-type: none"> • DMAC Filter 	<p>Specify the destination MAC filter for this ACE.</p> <p>Any: No DMAC filter is specified. (DMAC filter status is "don't-care".)</p> <p>MC: Frame must be multicast.</p> <p>BC: Frame must be broadcast.</p> <p>UC: Frame must be unicast.</p> <p>Specific: If you want to filter a specific destination MAC address with this ACE, choose this value. A field for entering a DMAC value appears.</p>
<ul style="list-style-type: none"> • DMAC Value 	<p>When "Specific" is selected for the DMAC filter, you can enter a specific destination MAC address. The legal format is "xx-xx-xx-xx-xx-xx". A frame that hits this ACE matches this DMAC value.</p>

■ VLAN Parameters

Object	Description
<ul style="list-style-type: none"> • 802.1Q Tagged 	<p>Specify whether frames can hit the action according to the 802.1Q tagged. The allowed values are:</p> <p>Any: Any value is allowed ("don't-care").</p> <p>Enabled: Tagged frame only.</p> <p>Disabled: Untagged frame only.</p> <p>The default value is "Any".</p>
<ul style="list-style-type: none"> • VLAN ID Filter 	<p>Specify the VLAN ID filter for this ACE.</p> <p>Any: No VLAN ID filter is specified. (VLAN ID filter status is "don't-care".)</p> <p>Specific: If you want to filter a specific VLAN ID with this ACE, choose this value. A field for entering a VLAN ID number appears.</p>
<ul style="list-style-type: none"> • VLAN ID 	<p>When "Specific" is selected for the VLAN ID filter, you can enter a specific VLAN ID number. The allowed range is 1 to 4095. A frame that hits this ACE matches this VLAN ID value.</p>
<ul style="list-style-type: none"> • Tag Priority 	<p>Specify the tag priority for this ACE. A frame that hits this ACE matches this tag priority. The allowed number range is 0 to 7. The value Any means that no tag priority is specified (tag priority is "don't-care".)</p>

■ ARP Parameters

The ARP parameters can be configured when Frame Type "ARP" is selected.

Object	Description
<ul style="list-style-type: none"> • ARP/RARP 	<p>Specify the available ARP/RARP opcode (OP) flag for this ACE.</p> <p>Any: No ARP/RARP OP flag is specified. (OP is "don't-care".)</p> <p>ARP: Frame must have ARP/RARP opcode set to ARP.</p> <p>RARP: Frame must have ARP/RARP opcode set to RARP.</p> <p>Other: Frame has unknown ARP/RARP Opcode flag.</p>
<ul style="list-style-type: none"> • Request/Reply 	<p>Specify the available ARP/RARP opcode (OP) flag for this ACE.</p> <p>Any: No ARP/RARP OP flag is specified. (OP is "don't-care".)</p> <p>Request: Frame must have ARP Request or RARP Request OP flag set.</p> <p>Reply: Frame must have ARP Reply or RARP Reply OP flag.</p>
<ul style="list-style-type: none"> • Sender IP Filter 	<p>Specify the sender IP filter for this ACE.</p> <p>Any: No sender IP filter is specified. (Sender IP filter is "don't-care".)</p> <p>Host: Sender IP filter is set to Host. Specify the sender IP address in the SIP Address field that appears.</p> <p>Network: Sender IP filter is set to Network. Specify the sender IP address and sender IP mask in the SIP Address and SIP Mask fields that appear.</p>
<ul style="list-style-type: none"> • Sender IP Address 	<p>When "Host" or "Network" is selected for the sender IP filter, you can enter a specific sender IP address in dotted decimal notation.</p>
<ul style="list-style-type: none"> • Sender IP Mask 	<p>When "Network" is selected for the sender IP filter, you can enter a specific sender IP mask in dotted decimal notation.</p>
<ul style="list-style-type: none"> • Target IP Filter 	<p>Specify the target IP filter for this specific ACE.</p> <p>Any: No target IP filter is specified. (Target IP filter is "don't-care".)</p> <p>Host: Target IP filter is set to Host. Specify the target IP address in the Target IP Address field that appears.</p> <p>Network: Target IP filter is set to Network. Specify the target IP address and target IP mask in the Target IP Address and Target IP Mask fields that appear.</p>
<ul style="list-style-type: none"> • Target IP Address 	<p>When "Host" or "Network" is selected for the target IP filter, you can enter a specific target IP address in dotted decimal notation.</p>
<ul style="list-style-type: none"> • Target IP Mask 	<p>When "Network" is selected for the target IP filter, you can enter a specific target IP mask in dotted decimal notation.</p>
<ul style="list-style-type: none"> • ARP SMAC Match 	<p>Specify whether frames can hit the action according to their sender hardware address field (SHA) settings.</p> <p>0: ARP frames where SHA is not equal to the SMAC address.</p> <p>1: ARP frames where SHA is equal to the SMAC address.</p> <p>Any: Any value is allowed ("don't-care").</p>
<ul style="list-style-type: none"> • RARP SMAC Match 	<p>Specify whether frames can hit the action according to their target hardware</p>

	<p>address field (THA) settings.</p> <p>0: RARP frames where THA is not equal to the SMAC address.</p> <p>1: RARP frames where THA is equal to the SMAC address.</p> <p>Any: Any value is allowed ("don't-care").</p>
<ul style="list-style-type: none"> • IP/Ethernet Length 	<p>Specify whether frames can hit the action according to their ARP/RARP hardware address length (HLN) and protocol address length (PLN) settings.</p> <p>0: ARP/RARP frames where the HLN is equal to Ethernet (0x06) and the (PLN) is equal to IPv4 (0x04).</p> <p>1: ARP/RARP frames where the HLN is equal to Ethernet (0x06) and the (PLN) is equal to IPv4 (0x04).</p> <p>Any: Any value is allowed ("don't-care").</p>
<ul style="list-style-type: none"> • IP 	<p>Specify whether frames can hit the action according to their ARP/RARP hardware address space (HRD) settings.</p> <p>0: ARP/RARP frames where the HLD is equal to Ethernet (1).</p> <p>1: ARP/RARP frames where the HLD is equal to Ethernet (1).</p> <p>Any: Any value is allowed ("don't-care").</p>
<ul style="list-style-type: none"> • Ethernet 	<p>Specify whether frames can hit the action according to their ARP/RARP protocol address space (PRO) settings.</p> <p>0: ARP/RARP frames where the PRO is equal to IP (0x800).</p> <p>1: ARP/RARP frames where the PRO is equal to IP (0x800).</p> <p>Any: Any value is allowed ("don't-care").</p>

■ **IP Parameters**

The IP parameters can be configured when Frame Type "IPv4" is selected.

Object	Description
<ul style="list-style-type: none"> • IP Protocol Filter 	<p>Specify the IP protocol filter for this ACE.</p> <p>Any: No IP protocol filter is specified ("don't-care").</p> <p>Specific: If you want to filter a specific IP protocol filter with this ACE, choose this value. A field for entering an IP protocol filter appears.</p> <p>ICMP: Select ICMP to filter IPv4 ICMP protocol frames. Extra fields for defining ICMP parameters will appear. These fields are explained later in this help file.</p> <p>UDP: Select UDP to filter IPv4 UDP protocol frames. Extra fields for defining UDP parameters will appear. These fields are explained later in this help file.</p> <p>TCP: Select TCP to filter IPv4 TCP protocol frames. Extra fields for defining TCP parameters will appear. These fields are explained later in this help file.</p>
<ul style="list-style-type: none"> • IP Protocol Value 	<p>When "Specific" is selected for the IP protocol value, you can enter a specific value. The allowed range is 0 to 255. A frame that hits this ACE matches this IP protocol value.</p>

<ul style="list-style-type: none"> • IP TTL 	<p>Specify the Time-to-Live settings for this ACE.</p> <p>zero: IPv4 frames with a Time-to-Live field greater than zero must not be able to match this entry.</p> <p>non-zero: IPv4 frames with a Time-to-Live field greater than zero must be able to match this entry.</p> <p>Any: Any value is allowed ("don't-care").</p>
<ul style="list-style-type: none"> • IP Fragment 	<p>Specify the fragment offset settings for this ACE. This involves the settings for the More Fragments (MF) bit and the Fragment Offset (FRAG OFFSET) field for an IPv4 frame.</p> <p>No: IPv4 frames where the MF bit is set or the FRAG OFFSET field is greater than zero must not be able to match this entry.</p> <p>Yes: IPv4 frames where the MF bit is set or the FRAG OFFSET field is greater than zero must be able to match this entry.</p> <p>Any: Any value is allowed ("don't-care").</p>
<ul style="list-style-type: none"> • IP Option 	<p>Specify the options flag setting for this ACE.</p> <p>No: IPv4 frames where the options flag is set must not be able to match this entry.</p> <p>Yes: IPv4 frames where the options flag is set must be able to match this entry.</p> <p>Any: Any value is allowed ("don't-care").</p>
<ul style="list-style-type: none"> • SIP Filter 	<p>Specify the source IP filter for this ACE.</p> <p>Any: No source IP filter is specified. (Source IP filter is "don't-care".)</p> <p>Host: Source IP filter is set to Host. Specify the source IP address in the SIP Address field that appears.</p> <p>Network: Source IP filter is set to Network. Specify the source IP address and source IP mask in the SIP Address and SIP Mask fields that appear.</p>
<ul style="list-style-type: none"> • SIP Address 	<p>When "Host" or "Network" is selected for the source IP filter, you can enter a specific SIP address in dotted decimal notation.</p>
<ul style="list-style-type: none"> • SIP Mask 	<p>When "Network" is selected for the source IP filter, you can enter a specific SIP mask in dotted decimal notation.</p>
<ul style="list-style-type: none"> • DIP Filter 	<p>Specify the destination IP filter for this ACE.</p> <p>Any: No destination IP filter is specified. (Destination IP filter is "don't-care".)</p> <p>Host: Destination IP filter is set to Host. Specify the destination IP address in the DIP Address field that appears.</p> <p>Network: Destination IP filter is set to Network. Specify the destination IP address and destination IP mask in the DIP Address and DIP Mask fields that appear.</p>
<ul style="list-style-type: none"> • DIP Address 	<p>When "Host" or "Network" is selected for the destination IP filter, you can enter a specific DIP address in dotted decimal notation.</p>
<ul style="list-style-type: none"> • DIP Mask 	<p>When "Network" is selected for the destination IP filter, you can enter a specific</p>

	DIP mask in dotted decimal notation.
--	--------------------------------------

■ ICMP Parameters

Object	Description
<ul style="list-style-type: none"> • ICMP Type Filter 	<p>Specify the ICMP filter for this ACE.</p> <p>Any: No ICMP filter is specified (ICMP filter status is "don't-care").</p> <p>Specific: If you want to filter a specific ICMP filter with this ACE, you can enter a specific ICMP value. A field for entering an ICMP value appears.</p>
<ul style="list-style-type: none"> • ICMP Type Value 	<p>When "Specific" is selected for the ICMP filter, you can enter a specific ICMP value. The allowed range is 0 to 255. A frame that hits this ACE matches this ICMP value.</p>
<ul style="list-style-type: none"> • ICMP Code Filter 	<p>Specify the ICMP code filter for this ACE.</p> <p>Any: No ICMP code filter is specified (ICMP code filter status is "don't-care").</p> <p>Specific: If you want to filter a specific ICMP code filter with this ACE, you can enter a specific ICMP code value. A field for entering an ICMP code value appears.</p>
<ul style="list-style-type: none"> • ICMP Code Value 	<p>When "Specific" is selected for the ICMP code filter, you can enter a specific ICMP code value. The allowed range is 0 to 255. A frame that hits this ACE matches this ICMP code value.</p>

■ TCP/UDP Parameters

Object	Description
<ul style="list-style-type: none"> • TCP/UDP Source Filter 	<p>Specify the TCP/UDP source filter for this ACE.</p> <p>Any: No TCP/UDP source filter is specified (TCP/UDP source filter status is "don't-care").</p> <p>Specific: If you want to filter a specific TCP/UDP source filter with this ACE, you can enter a specific TCP/UDP source value. A field for entering a TCP/UDP source value appears.</p> <p>Range: If you want to filter a specific TCP/UDP source range filter with this ACE, you can enter a specific TCP/UDP source range value. A field for entering a TCP/UDP source value appears.</p>
<ul style="list-style-type: none"> • TCP/UDP Source No. 	<p>When "Specific" is selected for the TCP/UDP source filter, you can enter a specific TCP/UDP source value. The allowed range is 0 to 65535. A frame that hits this ACE matches this TCP/UDP source value.</p>
<ul style="list-style-type: none"> • TCP/UDP Source Range 	<p>When "Range" is selected for the TCP/UDP source filter, you can enter a specific TCP/UDP source range value. The allowed range is 0 to 65535. A frame that hits this ACE matches this TCP/UDP source value.</p>

<ul style="list-style-type: none"> • TCP/UDP Destination Filter 	<p>Specify the TCP/UDP destination filter for this ACE.</p> <p>Any: No TCP/UDP destination filter is specified (TCP/UDP destination filter status is "don't-care").</p> <p>Specific: If you want to filter a specific TCP/UDP destination filter with this ACE, you can enter a specific TCP/UDP destination value. A field for entering a TCP/UDP destination value appears.</p> <p>Range: If you want to filter a specific range TCP/UDP destination filter with this ACE, you can enter a specific TCP/UDP destination range value. A field for entering a TCP/UDP destination value appears.</p>
<ul style="list-style-type: none"> • TCP/UDP Destination Number 	<p>When "Specific" is selected for the TCP/UDP destination filter, you can enter a specific TCP/UDP destination value. The allowed range is 0 to 65535. A frame that hits this ACE matches this TCP/UDP destination value.</p>
<ul style="list-style-type: none"> • TCP/UDP Destination Range 	<p>When "Range" is selected for the TCP/UDP destination filter, you can enter a specific TCP/UDP destination range value. The allowed range is 0 to 65535. A frame that hits this ACE matches this TCP/UDP destination value.</p>
<ul style="list-style-type: none"> • TCP FIN 	<p>Specify the TCP "No more data from sender" (FIN) value for this ACE.</p> <p>0: TCP frames where the FIN field is set must not be able to match this entry.</p> <p>1: TCP frames where the FIN field is set must be able to match this entry.</p> <p>Any: Any value is allowed ("don't-care").</p>
<ul style="list-style-type: none"> • TCP SYN 	<p>Specify the TCP "Synchronize sequence numbers" (SYN) value for this ACE.</p> <p>0: TCP frames where the SYN field is set must not be able to match this entry.</p> <p>1: TCP frames where the SYN field is set must be able to match this entry.</p> <p>Any: Any value is allowed ("don't-care").</p>
<ul style="list-style-type: none"> • TCP RST 	<p>Specify the TCP "Reset the connection" (RST) value for this ACE.</p> <p>0: TCP frames where the RST field is set must not be able to match this entry.</p> <p>1: TCP frames where the RST field is set must be able to match this entry.</p> <p>Any: Any value is allowed ("don't-care").</p>
<ul style="list-style-type: none"> • TCP PSH 	<p>Specify the TCP "Push Function" (PSH) value for this ACE.</p> <p>0: TCP frames where the PSH field is set must not be able to match this entry.</p> <p>1: TCP frames where the PSH field is set must be able to match this entry.</p> <p>Any: Any value is allowed ("don't-care").</p>
<ul style="list-style-type: none"> • TCP ACK 	<p>Specify the TCP "Acknowledgment field significant" (ACK) value for this ACE.</p> <p>0: TCP frames where the ACK field is set must not be able to match this entry.</p> <p>1: TCP frames where the ACK field is set must be able to match this entry.</p> <p>Any: Any value is allowed ("don't-care").</p>
<ul style="list-style-type: none"> • TCP URG 	<p>Specify the TCP "Urgent Pointer field significant" (URG) value for this ACE.</p> <p>0: TCP frames where the URG field is set must not be able to match this entry.</p> <p>1: TCP frames where the URG field is set must be able to match this entry.</p> <p>Any: Any value is allowed ("don't-care").</p>

■ Ethernet Type Parameters

The Ethernet Type parameters can be configured when Frame Type "Ethernet Type" is selected.

Object	Description
<ul style="list-style-type: none"> EtherType Filter 	Specify the Ethernet type filter for this ACE. Any: No EtherType filter is specified (EtherType filter status is "don't-care"). Specific: If you want to filter a specific EtherType filter with this ACE, you can enter a specific EtherType value. A field for entering a EtherType value appears.
<ul style="list-style-type: none"> Ethernet Type Value 	When "Specific" is selected for the EtherType filter, you can enter a specific EtherType value. The allowed range is 0x600 to 0xFFFF but excluding 0x800(IPv4), 0x806(ARP) and 0x86DD(IPv6). A frame that hits this ACE matches this EtherType value.

Buttons

: Click to save changes.

: Click to undo any changes made locally and revert to previously saved values.

: Return to the previous page.

4.10.4 ACL Ports Configuration

Configure the ACL parameters (ACE) of each switch port. These parameters will affect frames received on a port unless the frame matches a specific ACE.

The ACL Ports Configuration screen in [Figure 4-10-4](#) appears.

ACL Ports Configuration

Port	Policy ID	Action	Rate Limiter ID	EVC Policer	EVC Policer ID	Port Redirect	Mirror	Logging	Shutdown	State	Counter
*	0	<All>	<All>	<All>	0	<All>	<All>	<All>	<All>	<All>	*
1	0	Permit	Disablec	Disabled	0	Disabled	Disabled	Enabled	Disabled	Disabled	NaN
2	0	Permit	Disablec	Disabled	0	Disabled	Disabled	Enabled	Disabled	Disabled	NaN
3	0	Permit	Disablec	Disabled	0	Disabled	Disabled	Enabled	Disabled	Disabled	NaN
4	0	Permit	Disablec	Disabled	0	Disabled	Disabled	Enabled	Disabled	Disabled	NaN
5	0	Permit	Disablec	Disabled	0	Disabled	Disabled	Enabled	Disabled	Disabled	NaN
6	0	Permit	Disablec	Disabled	0	Disabled	Disabled	Enabled	Disabled	Disabled	NaN
7	0	Permit	Disablec	Disabled	0	Disabled	Disabled	Enabled	Disabled	Disabled	NaN
8	0	Permit	Disablec	Disabled	0	Disabled	Disabled	Enabled	Disabled	Disabled	NaN
9	0	Permit	Disablec	Disabled	0	Disabled	Disabled	Enabled	Disabled	Disabled	NaN
10	0	Permit	Disablec	Disabled	0	Disabled	Disabled	Enabled	Disabled	Disabled	NaN

Figure 4-10-4: ACL Ports Configuration Page Screenshot

The page includes the following fields:

Object	Description
• Port	The logical port for the settings contained in the same row.
• Policy ID	Select the policy to apply to this port. The allowed values are 1 through 8 . The default value is 1 .
• Action	Select whether forwarding is permitted ("Permit") or denied ("Deny"). The default value is " Permit ". All means all ports will have one specific setting.
• Rate Limiter ID	Select which rate limiter to apply to this port. The allowed values are Disabled or the values 1 through 15 . The default value is " Disabled ". All means all ports will have one specific setting.
• EVC Policer	Select whether EVC policer is enabled or disabled. The default value is " Disabled ". All means all ports will have one specific setting.
• EVC Policer ID	Select which EVC policer ID to apply on this port. The allowed values are Disabled or the values 1 through 128 .
• Port Redirect	Select which port frames are redirected on. The allowed values are Disabled or a specific port number. The default value is " Disabled ". All means all ports will have one specific setting.
• Mirror	Specify the mirror operation of this port. The allowed values are: Enabled : Frames received on the port are mirrored. Disabled : Frames received on the port are not mirrored. The default value is " Disabled ". All means all ports will have one specific setting.
• Logging	Specify the logging operation of this port. The allowed values are: Enabled : Frames received on the port are stored in the System Log. Disabled : Frames received on the port are not logged. The default value is " Disabled ". Please note that the System Log memory size and logging rate is limited. All means all ports will have one specific setting.
• Shutdown	Specify the port shut down operation of this port. The allowed values are: Enabled : If a frame is received on the port, the port will be disabled. Disabled : Port shut down is disabled. The default value is " Disabled ". All means all ports will have one specific setting.
• State	Specify the port state of this port. The allowed values are: Enabled : To reopen ports by changing the volatile port configuration of the ACL user module. Disabled : To close ports by changing the volatile port configuration of the ACL user module. The default value is " Enabled ".

	All means all ports will have one specific setting.
• Counter	Counts the number of frames that match this ACE.

Buttons

Save: Click to save changes.

Reset: Click to undo any changes made locally and revert to previously saved values.

Refresh: Click to refresh the page; any changes made locally will be undone.

Clear: Click to clear the counters.

4.10.5 ACL Rate Limiter Configuration

Configure the rate limiter for the ACL of the switch.

The ACL Rate Limiter Configuration screen in [Figure 4-10-5](#) appears.

ACL Rate Limiter Configuration

Rate Limiter ID	Rate	Unit
*	1	<All> ▼
1	1	pps ▼
2	1	pps ▼
3	1	pps ▼
4	1	pps ▼
5	1	pps ▼
6	1	pps ▼
7	1	pps ▼
8	1	pps ▼
9	1	pps ▼
10	1	pps ▼
11	1	pps ▼
12	1	pps ▼
13	1	pps ▼
14	1	pps ▼
15	1	pps ▼
16	1	pps ▼

Save **Reset**

Figure 4-10-5: ACL Rate Limiter Configuration Page Screenshot

The page includes the following fields:

Object	Description
• Rate Limiter ID	The rate limiter ID for the settings contained in the same row.
• Rate	The allowed values are: 0-3276700 in pps or 0, 100, 200, 300, ..., 1000000 in kbps.
• Unit	Specify the rate unit. The allowed values are: pps : packets per second. kbps : Kbits per second. All means all ports will have one specific setting.

Buttons

: Click to save changes.

: Click to undo any changes made locally and revert to previously saved values.

4.11 Authentication

This section is to control the access of the Managed Switch, includes the user access and management control.

The Authentication section contains links to the following main topics:

- **IEEE 802.1X Port-Based Network Access Control**
- **MAC-Based Authentication**
- **User Authentication**

Overview of 802.1X (Port-Based) Authentication

In the 802.1X-world, the user is called the supplicant, the switch is the authenticator, and the RADIUS server is the authentication server. The switch acts as the man-in-the-middle, forwarding requests and responses between the supplicant and the authentication server. Frames sent between the supplicant and the switch are special 802.1X frames, known as **EAPOL (EAP Over LANs)** frames. EAPOL frames encapsulate **EAP PDUs** (RFC3748). Frames sent between the switch and the RADIUS server are RADIUS packets. RADIUS packets also encapsulate EAP PDUs together with other attributes like the switch's IP address, name, and the supplicant's port number on the switch. EAP is very flexible, in that it allows for different authentication methods, like **MD5-Challenge**, **PEAP**, and **TLS**. The important thing is that the authenticator (the switch) doesn't need to know which authentication method the supplicant and the authentication server are using, or how many information exchange frames are needed for a particular method. The switch simply encapsulates the EAP part of the frame into the relevant type (EAPOL or RADIUS) and forwards it.

When authentication is complete, the RADIUS server sends a special packet containing a success or failure indication. Besides forwarding this decision to the supplicant, the switch uses it to open up or block traffic on the switch port connected to the supplicant.

Overview of MAC-Based Authentication

Unlike 802.1X, MAC-based authentication is not a standard, but merely a best-practices method adopted by the industry. In MAC-based authentication, users are called clients, and the switch acts as the supplicant on behalf of clients. The initial frame (any kind of frame) sent by a client is snooped by the switch, which in turn uses the client's MAC address as both username and password in the subsequent EAP exchange with the RADIUS server. The 6-byte MAC address is converted to a string on the following form "xx-xx-xx-xx-xx-xx", that is, a dash (-) is used as separator between the lower-cased hexadecimal digits. The switch only supports the MD5-Challenge authentication method, so the RADIUS server must be configured accordingly.

When authentication is complete, the RADIUS server sends a success or failure indication, which in turn causes the switch to open up or block traffic for that particular client, using static entries into the MAC Table. Only then will frames from the client be forwarded on the switch. There are no EAPOL frames involved in this authentication, and therefore, MAC-based Authentication has nothing to do with the 802.1X standard.

The advantage of MAC-based authentication over 802.1X is that several clients can be connected to the same port (e.g. through a 3rd party switch or a hub) and still require individual authentication, and that the clients don't need special supplicant software to authenticate. The disadvantage is that MAC addresses can be spoofed by malicious users, equipment whose MAC address

is a valid RADIUS user can be used by anyone, and only the MD5-Challenge method is supported.

The 802.1X and MAC-Based Authentication configuration consists of two sections, a system- and a port-wide.

Overview of User Authentication

It is allowed to configure the Managed Switch to authenticate users logging into the system for management access using local or remote authentication methods, such as telnet and Web browser. This Managed Switch provides secure network management access using the following options:

- **Remote Authentication Dial-in User Service (RADIUS)**
- **Terminal Access Controller Access Control System Plus (TACACS+)**
- **Local user name and Privilege Level control**

RADIUS and TACACS+ are logon authentication protocols that use software running on a central server to control access to RADIUS-aware or TACACS-aware devices on the network. An **authentication server** contains a database of multiple user name / password pairs with associated privilege levels for each user that requires management access to the Managed Switch.

4.11.1 Understanding IEEE 802.1X Port-Based Authentication

The IEEE 802.1X standard defines a client-server-based access control and authentication protocol that restricts unauthorized clients from connecting to a LAN through publicly accessible ports. The authentication server authenticates each client connected to a switch port before making available any services offered by the switch or the LAN.

Until the client is authenticated, 802.1X access control allows only **Extensible Authentication Protocol over LAN (EAPOL)** traffic through the port to which the client is connected. After authentication is successful, normal traffic can pass through the port.

This section includes this conceptual information:

- Device Roles
- Authentication Initiation and Message Exchange
- Ports in Authorized and Unauthorized States

■ Device Roles

With 802.1X port-based authentication, the devices in the network have specific roles as shown below.

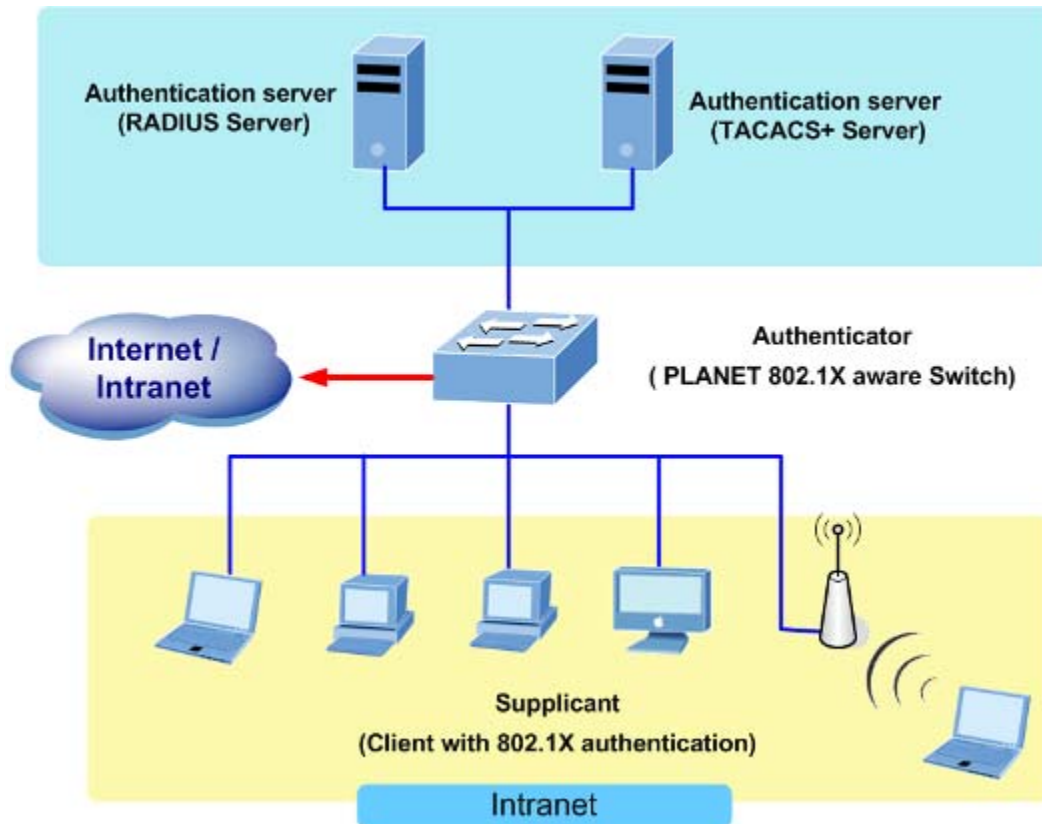

Figure 4-11-1

- **Client**—the device (workstation) that requests access to the LAN and switch services and responds to requests from the switch. The workstation must be running 802.1X-compliant client software such as that offered in the Microsoft Windows XP operating system. (The client is the *supplicant* in the IEEE 802.1X specification.)
- **Authentication server**—performs the actual authentication of the client. The authentication server validates the identity of the client and notifies the switch whether or not the client is authorized to access the LAN and switch services. Because the switch acts as the proxy, the authentication service is transparent to the client. In this release, the Remote Authentication Dial-In User Service (RADIUS) security system with **Extensible Authentication Protocol (EAP)** extensions is the only supported authentication server; it is available in Cisco Secure Access Control Server version 3.0. RADIUS operates in a client/server model in which secure authentication information is exchanged between the RADIUS server and one or more RADIUS clients.
- **Switch (802.1X device)**—controls the physical access to the network based on the authentication status of the client. The switch acts as an intermediary (proxy) between the client and the authentication server, requesting identity information from the client, verifying that information with the authentication server, and relaying a response to the client.

The switch includes the RADIUS client, which is responsible for encapsulating and decapsulating the Extensible Authentication Protocol (EAP) frames and interacting with the authentication server. When the switch receives EAPOL frames and relays them to the authentication server, the Ethernet header is stripped and the remaining EAP frame is re-encapsulated in the RADIUS format. The EAP frames are not modified or examined during encapsulation, and the authentication server must support EAP within the native frame format. When the switch receives frames from the authentication server, the server's frame header is removed, leaving the EAP frame, which is then encapsulated for Ethernet and sent to the client.

■ Authentication Initiation and Message Exchange

The switch or the client can initiate authentication. If you enable authentication on a port by using the **dot1x port-control auto** interface configuration command, the switch must initiate authentication when it determines that the port link state transitions from down to up. It then sends an EAP-request/identity frame to the client to request its identity (typically, the switch sends an initial identity/request frame followed by one or more requests for authentication information). Upon receipt of the frame, the client responds with an EAP-response/identity frame.

However, if during bootup, the client does not receive an EAP-request/identity frame from the switch, the client can initiate authentication by sending an EAPOL-start frame, which prompts the switch to request the client's identity



If 802.1X is not enabled or supported on the network access device, any EAPOL frames from the client are dropped. If the client does not receive an EAP-request/identity frame after three attempts to start authentication, the client transmits frames as if the port was in the authorized state. A port in the authorized state effectively means that the client has been successfully authenticated.

When the client supplies its identity, the switch begins its role as the intermediary, passing EAP frames between the client and the authentication server until authentication succeeds or fails. If the authentication succeeds, the switch port becomes authorized.

The specific exchange of EAP frames depends on the authentication method being used. "Figure 4-11-2" shows a message exchange initiated by the client using the One-Time-Password (OTP) authentication method with a RADIUS server.

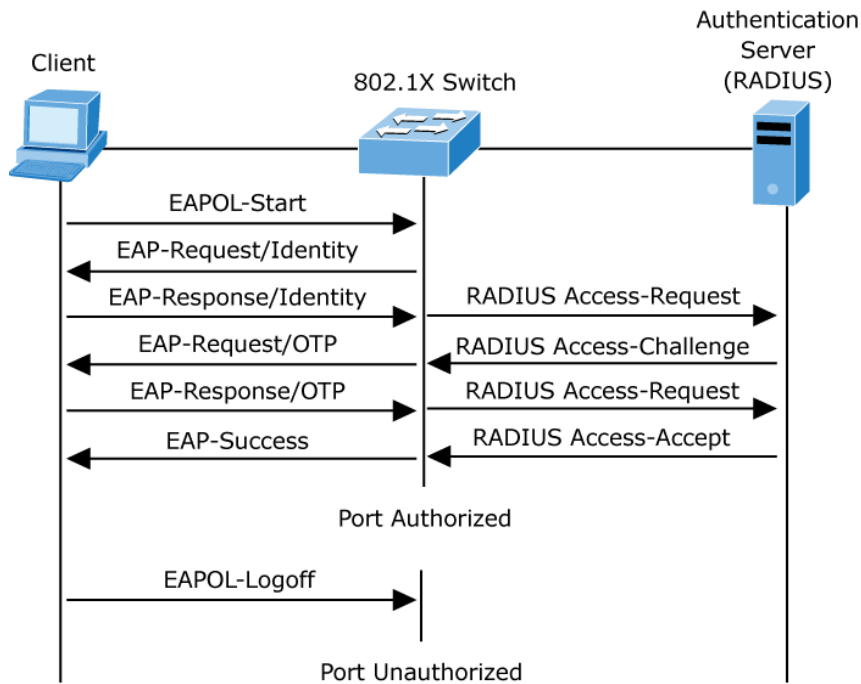

Figure 4-11-2: EAP Message Exchange

■ Ports in Authorized and Unauthorized States

The switch port state determines whether or not the client is granted access to the network. The port starts in the *unauthorized* state. While in this state, the port disallows all ingress and egress traffic except for 802.1X protocol packets. When a client is successfully authenticated, the port transitions to the *authorized* state, allowing all traffic for the client to flow normally.

If a client that does not support 802.1X is connected to an unauthorized 802.1X port, the switch requests the client's identity. In this situation, the client does not respond to the request, the port remains in the unauthorized state, and the client is not granted access to the network.

In contrast, when an 802.1X-enabled client connects to a port that is not running the 802.1X protocol, the client initiates the authentication process by sending the EAPOL-start frame. When no response is received, the client sends the request for a fixed number of times. Because no response is received, the client begins sending frames as if the port is in the authorized state.

If the client is successfully authenticated (receives an Accept frame from the authentication server), the port state changes to authorized, and all frames from the authenticated client are allowed through the port. If the authentication fails, the port remains in the unauthorized state, but authentication can be retried. If the authentication server cannot be reached, the switch can retransmit the request. If no response is received from the server after the specified number of attempts, authentication fails, and network access is not granted.

When a client logs off, it sends an EAPOL-logoff message, causing the switch port to transition to the unauthorized state.

If the link state of a port transitions from up to down, or if an EAPOL-logoff frame is received, the port returns to the unauthorized state.

4.11.2 Authentication Configuration

This page allows you to configure how a user is authenticated when he logs into the switch via one of the management client interfaces. The Authentication Method Configuration screen in [Figure 4-11-3](#) appears.

Authentication Method Configuration

Client	Authentication Method	Fallback
telnet	local	<input type="checkbox"/>
ssh	local	<input type="checkbox"/>
web	local	<input type="checkbox"/>

Save Reset

Figure 4-11-3: Authentication Method Configuration Page Screenshot

The page includes the following fields:

Object	Description
• Client	The management client for which the configuration below applies.
• Authentication Method	<p>Authentication Method can be set to one of the following values:</p> <ul style="list-style-type: none"> ■ None: authentication is disabled and login is not possible. ■ local: use the local user database on the switch stack for authentication. ■ RADIUS: use a remote RADIUS server for authentication. ■ TACACS+: use a remote TACACS+ server for authentication.
• Fallback	<p>Enable fallback to local authentication by checking this box.</p> <p>If none of the configured authentication servers are alive, the local user database is used for authentication.</p> <p>This is only possible if the Authentication Method is set to something else than 'none' or 'local'.</p>

Buttons

Save: Click to save changes.

Reset: Click to undo any changes made locally and revert to previously saved values.

4.11.3 Network Access Server Configuration

This page allows you to configure the **IEEE 802.1X** and **MAC-based** authentication system and port settings.

The IEEE 802.1X standard defines a port-based access control procedure that prevents unauthorized access to a network by requiring users to first submit credentials for authentication. One or more central servers, the backend servers, determine whether the user is allowed access to the network. These backend (RADIUS) servers are configured on the "Configuration→Security→AAA" page. The IEEE802.1X standard defines port-based operation, but non-standard variants overcome security limitations as shall be explored below.

MAC-based authentication allows for authentication of more than one user on the same port, and doesn't require the user to have special 802.1X supplicant software installed on his system. The switch uses the user's MAC address to authenticate against the backend server. Intruders can create counterfeit MAC addresses, which makes MAC-based authentication less secure than 802.1X authentication. The NAS configuration consists of two sections, a system- and a port-wide. The Network Access Server Configuration screen in [Figure 4-11-4](#) appears.

Network Access Server Configuration

System Configuration

Mode	Disabled ▼
Reauthentication Enabled	<input type="checkbox"/>
Reauthentication Period	3600 seconds
EAPOL Timeout	30 seconds
Aging Period	300 seconds
Hold Time	10 seconds
RADIUS-Assigned QoS Enabled	<input type="checkbox"/>
RADIUS-Assigned VLAN Enabled	<input type="checkbox"/>
Guest VLAN Enabled	<input type="checkbox"/>
Guest VLAN ID	1
Max. Reauth. Count	2
Allow Guest VLAN if EAPOL Seen	<input type="checkbox"/>

Port Configuration

Port	Admin State	RADIUS-Assigned QoS Enabled	RADIUS-Assigned VLAN Enabled	Guest VLAN Enabled	Port State	Restart	
*	<All> ▼	<input type="checkbox"/>	<input type="checkbox"/>	<input type="checkbox"/>			
1	Force Authorized ▼	<input type="checkbox"/>	<input type="checkbox"/>	<input type="checkbox"/>	Globally Disabled	Reauthenticate	Reinitialize
2	Force Authorized ▼	<input type="checkbox"/>	<input type="checkbox"/>	<input type="checkbox"/>	Globally Disabled	Reauthenticate	Reinitialize
3	Force Authorized ▼	<input type="checkbox"/>	<input type="checkbox"/>	<input type="checkbox"/>	Globally Disabled	Reauthenticate	Reinitialize
4	Force Authorized ▼	<input type="checkbox"/>	<input type="checkbox"/>	<input type="checkbox"/>	Globally Disabled	Reauthenticate	Reinitialize
5	Force Authorized ▼	<input type="checkbox"/>	<input type="checkbox"/>	<input type="checkbox"/>	Globally Disabled	Reauthenticate	Reinitialize
6	Force Authorized ▼	<input type="checkbox"/>	<input type="checkbox"/>	<input type="checkbox"/>	Globally Disabled	Reauthenticate	Reinitialize
7	Force Authorized ▼	<input type="checkbox"/>	<input type="checkbox"/>	<input type="checkbox"/>	Globally Disabled	Reauthenticate	Reinitialize
8	Force Authorized ▼	<input type="checkbox"/>	<input type="checkbox"/>	<input type="checkbox"/>	Globally Disabled	Reauthenticate	Reinitialize
9	Force Authorized ▼	<input type="checkbox"/>	<input type="checkbox"/>	<input type="checkbox"/>	Globally Disabled	Reauthenticate	Reinitialize
10	Force Authorized ▼	<input type="checkbox"/>	<input type="checkbox"/>	<input type="checkbox"/>	Globally Disabled	Reauthenticate	Reinitialize

Figure 4-11-4: Network Access Server Configuration Page Screenshot

The page includes the following fields:

System Configuration

Object	Description
<ul style="list-style-type: none"> • Mode 	<p>Indicates if NAS is globally enabled or disabled on the switch. If globally disabled, all ports are allowed forwarding of frames.</p>
<ul style="list-style-type: none"> • Reauthentication Enabled 	<p>If checked, successfully authenticated supplicants/clients are reauthenticated after the interval specified by the Reauthentication Period. Reauthentication for 802.1X-enabled ports can be used to detect if a new device is plugged into a switch port or if a supplicant is no longer attached.</p> <p>For MAC-based ports, reauthentication is only useful if the RADIUS server configuration has changed. It does not involve communication between the switch and the client, and therefore doesn't imply that a client is still present on a port.</p>
<ul style="list-style-type: none"> • Reauthentication Period 	<p>Determines the period, in seconds, after which a connected client must be reauthenticated. This is only active if the Reauthentication Enabled checkbox is checked. Valid values are in the range 1 to 3600 seconds.</p>
<ul style="list-style-type: none"> • EAPOL Timeout 	<p>Determines the time between retransmission of Request Identity EAPOL frames. Valid values are in the range 1 to 255 seconds. This has no effect for MAC-based ports.</p>
<ul style="list-style-type: none"> • Aging Period 	<p>This setting applies to the following modes, i.e. modes using the Port Security functionality to secure MAC addresses:</p> <ul style="list-style-type: none"> ■ Single 802.1X ■ Multi 802.1X ■ MAC-Based Auth. <p>When the NAS module uses the Port Security module to secure MAC addresses, the Port Security module needs to check for activity on the MAC address in question at regular intervals and free resources if no activity is seen within a given period of time. This parameter controls exactly this period and can be set to a number between 10 and 1000000 seconds.</p> <p>If reauthentication is enabled and the port is in a 802.1X-based mode, this is not so critical, since supplicants that are no longer attached to the port will get removed upon the next reauthentication, which will fail. But if reauthentication is not enabled, the only way to free resources is by aging the entries.</p> <p>For ports in MAC-based Auth. mode, reauthentication doesn't cause direct</p>

	<p>communication between the switch and the client, so this will not detect whether the client is still attached or not, and the only way to free any resources is to age the entry.</p>
<ul style="list-style-type: none"> • Hold Time 	<p>This setting applies to the following modes, i.e. modes using the Port Security functionality to secure MAC addresses:</p> <ul style="list-style-type: none"> ■ Single 802.1X ■ Multi 802.1X ■ MAC-Based Auth. <p>If a client is denied access - either because the RADIUS server denies the client access or because the RADIUS server request times out (according to the timeout specified on the "Configuration→Security→AAA" page) - the client is put on hold in the Unauthorized state. The hold timer does not count during an on-going authentication.</p> <p>In MAC-based Auth. mode, the The switch will ignore new frames coming from the client during the hold time.</p> <p>The Hold Time can be set to a number between 10 and 1000000 seconds.</p>
<ul style="list-style-type: none"> • RADIUS-Assigned QoS Enabled 	<p>RADIUS-assigned QoS provides a means to centrally control the traffic class to which traffic coming from a successfully authenticated supplicant is assigned on the switch. The RADIUS server must be configured to transmit special RADIUS attributes to take advantage of this feature (see RADIUS-Assigned QoS Enabled below for a detailed description).</p> <p>The "RADIUS-Assigned QoS Enabled" checkbox provides a quick way to globally enable/disable RADIUS-server assigned QoS Class functionality. When checked, the individual ports' ditto setting determine whether RADIUS-assigned QoS Class is enabled for that port. When unchecked, RADIUS-server assigned QoS Class is disabled for all ports.</p>
<ul style="list-style-type: none"> • RADIUS-Assigned VLAN Enabled 	<p>RADIUS-assigned VLAN provides a means to centrally control the VLAN on which a successfully authenticated supplicant is placed on the switch. Incoming traffic will be classified to and switched on the RADIUS-assigned VLAN. The RADIUS server must be configured to transmit special RADIUS attributes to take advantage of this feature (see RADIUS-Assigned VLAN Enabled below for a detailed description).</p> <p>The "RADIUS-Assigned VLAN Enabled" checkbox provides a quick way to globally enable/disable RADIUS-server assigned VLAN functionality. When checked, the individual ports' ditto setting determine whether RADIUS-assigned VLAN is enabled for that port. When unchecked, RADIUS-server assigned VLAN</p>

	is disabled for all ports.
<ul style="list-style-type: none"> • Guest VLAN Enabled 	<p>A Guest VLAN is a special VLAN - typically with limited network access - on which 802.1X-unaware clients are placed after a network administrator-defined timeout. The switch follows a set of rules for entering and leaving the Guest VLAN as listed below.</p> <p>The "Guest VLAN Enabled" checkbox provides a quick way to globally enable/disable Guest VLAN functionality. When checked, the individual ports' ditto setting determines whether the port can be moved into Guest VLAN. When unchecked, the ability to move to the Guest VLAN is disabled for all ports.</p>
<ul style="list-style-type: none"> • Guest VLAN ID 	<p>This is the value that a port's Port VLAN ID is set to if a port is moved into the Guest VLAN. It is only changeable if the Guest VLAN option is globally enabled.</p> <p>Valid values are in the range [1; 4095].</p>
<ul style="list-style-type: none"> • Max. Reauth. Count 	<p>The number of times that the switch transmits an EAPOL Request Identity frame without response before considering entering the Guest VLAN is adjusted with this setting. The value can only be changed if the Guest VLAN option is globally enabled.</p> <p>Valid values are in the range [1; 255].</p>
<ul style="list-style-type: none"> • Allow Guest VLAN if EAPOL Seen 	<p>The switch remembers if an EAPOL frame has been received on the port for the life-time of the port. Once the switch considers whether to enter the Guest VLAN, it will first check if this option is enabled or disabled. If disabled (unchecked; default), the switch will only enter the Guest VLAN if an EAPOL frame has not been received on the port for the life-time of the port. If enabled (checked), the switch will consider entering the Guest VLAN even if an EAPOL frame has been received on the port for the life-time of the port.</p> <p>The value can only be changed if the Guest VLAN option is globally enabled.</p>

Port Configuration

The table has one row for each port on the selected switch in the stack and a number of columns, which are:

Object	Description
<ul style="list-style-type: none"> • Port 	The port number for which the configuration below applies.
<ul style="list-style-type: none"> • Admin State 	<p>The Configuration All with available options will assign to whole ports. If NAS is globally enabled, this selection controls the port's authentication mode. The following modes are available:</p> <ul style="list-style-type: none"> ■ Force Authorized

In this mode, the switch will send one EAPOL Success frame when the port link comes up, and any client on the port will be allowed network access without authentication.

■ **Force Unauthorized**

In this mode, the switch will send one EAPOL Failure frame when the port link comes up, and any client on the port will be disallowed network access.

■ **Port-based 802.1X**

In the 802.1X-world, the user is called the supplicant, the switch is the authenticator, and the RADIUS server is the authentication server. The authenticator acts as the man-in-the-middle, forwarding requests and responses between the supplicant and the authentication server. Frames sent between the supplicant and the switch are special 802.1X frames, known as EAPOL (EAP Over LANs) frames. EAPOL frames encapsulate EAP PDUs (RFC3748). Frames sent between the switch and the RADIUS server are RADIUS packets. RADIUS packets also encapsulate EAP PDUs together with other attributes like the switch's IP address, name, and the supplicant's port number on the switch. EAP is very flexible, in that it allows for different authentication methods, like MD5-Challenge, PEAP, and TLS. The important thing is that the authenticator (the switch) doesn't need to know which authentication method the supplicant and the authentication server are using, or how many information exchange frames are needed for a particular method. The switch simply encapsulates the EAP part of the frame into the relevant type (EAPOL or RADIUS) and forwards it.

When authentication is complete, the RADIUS server sends a special packet containing a success or failure indication. Besides forwarding this decision to the supplicant, the switch uses it to open up or block traffic on the switch port connected to the supplicant.

Note: Suppose two backend servers are enabled and that the server timeout is configured to X seconds (using the AAA configuration page), and suppose that the first server in the list is currently down (but not considered dead). Now, if the supplicant retransmits EAPOL Start frames at a rate faster than X seconds, then it will never get authenticated, because the switch will cancel on-going backend authentication server requests whenever it receives a new EAPOL Start frame from the supplicant. And since the server hasn't yet failed (because the X seconds haven't expired), the same server will be contacted upon the next backend authentication server request from the switch. This scenario will loop forever. Therefore, the server timeout should

be smaller than the supplicant's EAPOL Start frame retransmission rate.

■ **Single 802.1X**

In port-based 802.1X authentication, once a supplicant is successfully authenticated on a port, the whole port is opened for network traffic. This allows other clients connected to the port (for instance through a hub) to piggy-back on the successfully authenticated client and get network access even though they really aren't authenticated. To overcome this security breach, use the Single 802.1X variant.

Single 802.1X is really not an IEEE standard, but features many of the same characteristics as does port-based 802.1X. In Single 802.1X, at most one supplicant can get authenticated on the port at a time. Normal EAPOL frames are used in the communication between the supplicant and the switch. If more than one supplicant is connected to a port, the one that comes first when the port's link comes up will be the first one considered. If that supplicant doesn't provide valid credentials within a certain amount of time, another supplicant will get a chance. Once a supplicant is successfully authenticated, only that supplicant will be allowed access. This is the most secure of all the supported modes. In this mode, the Port Security module is used to secure a supplicant's MAC address once successfully authenticated.

■ **Multi 802.1X**

In port-based 802.1X authentication, once a supplicant is successfully authenticated on a port, the whole port is opened for network traffic. This allows other clients connected to the port (for instance through a hub) to piggy-back on the successfully authenticated client and get network access even though they really aren't authenticated. To overcome this security breach, use the Multi 802.1X variant.

Multi 802.1X is really not an IEEE standard, but features many of the same characteristics as does port-based 802.1X. Multi 802.1X is - like Single 802.1X - not an IEEE standard, but a variant that features many of the same characteristics. In Multi 802.1X, one or more supplicants can get authenticated on the same port at the same time. Each supplicant is authenticated individually and secured in the MAC table using the Port Security module.

In Multi 802.1X it is not possible to use the multicast BPDU MAC address as destination MAC address for EAPOL frames sent from the switch towards the supplicant, since that would cause all supplicants attached to the port to reply to requests sent from the switch. Instead, the switch uses the

supplicant's MAC address, which is obtained from the first EAPOL Start or EAPOL Response Identity frame sent by the supplicant. An exception to this is when no supplicants are attached. In this case, the switch sends EAPOL Request Identity frames using the BPDU multicast MAC address as destination - to wake up any supplicants that might be on the port.

The maximum number of supplicants that can be attached to a port can be limited using the Port Security Limit Control functionality.

■ **MAC-based Auth.**

Unlike port-based 802.1X, MAC-based authentication is not a standard, but merely a best-practices method adopted by the industry. In MAC-based authentication, users are called clients, and the switch acts as the supplicant on behalf of clients. The initial frame (any kind of frame) sent by a client is snooped by the switch, which in turn uses the client's MAC address as both username and password in the subsequent EAP exchange with the RADIUS server. The 6-byte MAC address is converted to a string on the following form "xx-xx-xx-xx-xx-xx", that is, a dash (-) is used as separator between the lower-cased hexadecimal digits. The switch only supports the MD5-Challenge authentication method, so the RADIUS server must be configured accordingly.

When authentication is complete, the RADIUS server sends a success or failure indication, which in turn causes the switch to open up or block traffic for that particular client, using the Port Security module. Only then will frames from the client be forwarded on the switch. There are no EAPOL frames involved in this authentication, and therefore, MAC-based Authentication has nothing to do with the 802.1X standard.

The advantage of MAC-based authentication over port-based 802.1X is that several clients can be connected to the same port (e.g. through a 3rd party switch or a hub) and still require individual authentication, and that the clients don't need special supplicant software to authenticate. The advantage of MAC-based authentication over 802.1X-based authentication is that the clients don't need special supplicant software to authenticate. The disadvantage is that MAC addresses can be spoofed by malicious users - equipment whose MAC address is a valid RADIUS user can be used by anyone. Also, only the MD5-Challenge method is supported. The maximum number of clients that can be attached to a port can be limited using the Port Security Limit Control functionality.

• **RADIUS-Assigned QoS**

When RADIUS-Assigned QoS is both globally enabled and enabled (checked)

<p>Enabled</p>	<p>for a given port, the switch reacts to QoS Class information carried in the RADIUS Access-Accept packet transmitted by the RADIUS server when a supplicant is successfully authenticated. If present and valid, traffic received on the supplicant's port will be classified to the given QoS Class. If (re-)authentication fails or the RADIUS Access-Accept packet no longer carries a QoS Class or it's invalid, or the supplicant is otherwise no longer present on the port, the port's QoS Class is immediately reverted to the original QoS Class (which may be changed by the administrator in the meanwhile without affecting the RADIUS-assigned).</p> <p>This option is only available for single-client modes, i.e.</p> <ul style="list-style-type: none"> • Port-based 802.1X • Single 802.1X <p>RADIUS attributes used in identifying a QoS Class:</p> <p>Refer to the written documentation for a description of the RADIUS attributes needed in order to successfully identify a QoS Class. The User-Priority-Table attribute defined in RFC4675 forms the basis for identifying the QoS Class in an Access-Accept packet.</p> <p>Only the first occurrence of the attribute in the packet will be considered, and to be valid, it must follow this rule:</p> <p>All 8 octets in the attribute's value must be identical and consist of ASCII characters in the range '0' - '3', which translates into the desired QoS Class in the range [0; 3].</p>
<ul style="list-style-type: none"> • RADIUS-Assigned VLAN Enabled 	<p>When RADIUS-Assigned VLAN is both globally enabled and enabled (checked) for a given port, the switch reacts to VLAN ID information carried in the RADIUS Access-Accept packet transmitted by the RADIUS server when a supplicant is successfully authenticated. If present and valid, the port's Port VLAN ID will be changed to this VLAN ID, the port will be set to be a member of that VLAN ID, and the port will be forced into VLAN unaware mode. Once assigned, all traffic arriving on the port will be classified and switched on the RADIUS-assigned VLAN ID.</p> <p>If (re-)authentication fails or the RADIUS Access-Accept packet no longer carries a VLAN ID or it's invalid, or the supplicant is otherwise no longer present on the port, the port's VLAN ID is immediately reverted to the original VLAN ID (which may be changed by the administrator in the meanwhile without affecting the RADIUS-assigned).</p> <p>This option is only available for single-client modes, i.e.</p> <ul style="list-style-type: none"> ■ Port-based 802.1X

	<p>■ Single 802.1X</p> <p>For trouble-shooting VLAN assignments, use the "Monitor→VLANs→VLAN Membership and VLAN Port" pages. These pages show which modules have (temporarily) overridden the current Port VLAN configuration.</p> <p>RADIUS attributes used in identifying a VLAN ID:</p> <p>RFC2868 and RFC3580 form the basis for the attributes used in identifying a VLAN ID in an Access-Accept packet. The following criteria are used:</p> <ul style="list-style-type: none"> - The Tunnel-Medium-Type, Tunnel-Type, and Tunnel-Private-Group-ID attributes must all be present at least once in the Access-Accept packet. - The switch looks for the first set of these attributes that have the same Tag value and fulfil the following requirements (if Tag == 0 is used, the Tunnel-Private-Group-ID does not need to include a Tag): - Value of Tunnel-Medium-Type must be set to "IEEE-802" (ordinal 6). - Value of Tunnel-Type must be set to "VLAN" (ordinal 13). - Value of Tunnel-Private-Group-ID must be a string of ASCII chars in the range '0' - '9', which is interpreted as a decimal string representing the VLAN ID. Leading '0's are discarded. The final value must be in the range [1; 4095].
<ul style="list-style-type: none"> • Guest VLAN Enabled 	<p>When Guest VLAN is both globally enabled and enabled (checked) for a given port, the switch considers moving the port into the Guest VLAN according to the rules outlined below.</p> <p>This option is only available for EAPOL-based modes, i.e.:</p> <ul style="list-style-type: none"> ■ Port-based 802.1X ■ Single 802.1X ■ Multi 802.1X <p>For trouble-shooting VLAN assignments, use the "Monitor→VLANs→VLAN Membership and VLAN Port" pages. These pages show which modules have (temporarily) overridden the current Port VLAN configuration.</p> <p>Guest VLAN Operation:</p> <p>When a Guest VLAN enabled port's link comes up, the switch starts transmitting EAPOL Request Identity frames. If the number of transmissions of such frames exceeds Max. Reauth. Count and no EAPOL frames have been received in the meanwhile, the switch considers entering the Guest VLAN. The interval between transmission of EAPOL Request Identity frames is configured with EAPOL Timeout. If Allow Guest VLAN if EAPOL Seen is enabled, the port will now be</p>

	<p>placed in the Guest VLAN. If disabled, the switch will first check its history to see if an EAPOL frame has previously been received on the port (this history is cleared if the port link goes down or the port's Admin State is changed), and if not, the port will be placed in the Guest VLAN. Otherwise it will not move to the Guest VLAN, but continue transmitting EAPOL Request Identity frames at the rate given by EAPOL Timeout.</p> <p>Once in the Guest VLAN, the port is considered authenticated, and all attached clients on the port are allowed access on this VLAN. The switch will not transmit an EAPOL Success frame when entering the Guest VLAN.</p> <p>While in the Guest VLAN, the switch monitors the link for EAPOL frames, and if one such frame is received, the switch immediately takes the port out of the Guest VLAN and starts authenticating the supplicant according to the port mode. If an EAPOL frame is received, the port will never be able to go back into the Guest VLAN if the "Allow Guest VLAN if EAPOL Seen" is disabled.</p>
<ul style="list-style-type: none"> • Port State 	<p>The current state of the port. It can undertake one of the following values:</p> <ul style="list-style-type: none"> ■ Globally Disabled: NAS is globally disabled. ■ Link Down: NAS is globally enabled, but there is no link on the port. ■ Authorized: The port is in Force Authorized or a single-supplicant mode and the supplicant is authorized. ■ Unauthorized: The port is in Force Unauthorized or a single-supplicant mode and the supplicant is not successfully authorized by the RADIUS server. ■ X Auth/Y Unauth: The port is in a multi-supplicant mode. Currently X clients are authorized and Y are unauthorized.
<ul style="list-style-type: none"> • Restart 	<p>Two buttons are available for each row. The buttons are only enabled when authentication is globally enabled and the port's Admin State is in an EAPOL-based or MAC-based mode.</p> <p>Clicking these buttons will not cause settings changed on the page to take effect.</p> <ul style="list-style-type: none"> ■ Reauthenticate: Schedules a reauthentication to whenever the quiet-period of the port runs out (EAPOL-based authentication). For MAC-based authentication, reauthentication will be attempted immediately. <p>The button only has effect for successfully authenticated clients on the port and will not cause the clients to get temporarily unauthorized.</p> <ul style="list-style-type: none"> ■ Reinitialize: Forces a reinitialization of the clients on the port and thereby a reauthentication immediately. The clients will transfer to the unauthorized state while the reauthentication is in progress.

Buttons

Refresh: Click to refresh the page.

Save: Click to save changes.

Reset: Click to undo any changes made locally and revert to previously saved values.

4.11.4 Network Access Overview

This page provides an overview of the current NAS port states for the selected switch. The Network Access Overview screen in Figure 4-11-5 appears.

Network Access Server Switch Status						
Port	Admin State	Port State	Last Source	Last ID	QoS Class	Port VLAN ID
1	Force Authorized	Globally Disabled				
2	Force Authorized	Globally Disabled				
3	Force Authorized	Globally Disabled				
4	Force Authorized	Globally Disabled				
5	Force Authorized	Globally Disabled				
6	Force Authorized	Globally Disabled				
7	Force Authorized	Globally Disabled				
8	Force Authorized	Globally Disabled				
9	Force Authorized	Globally Disabled				
10	Force Authorized	Globally Disabled				

Auto-refresh **Refresh**

Figure 4-11-5: Network Access Server Switch Status Page Screenshot

The page includes the following fields:

Object	Description
• Port	The switch port number. Click to navigate to detailed NAS statistics for this port.
• Admin State	The port's current administrative state. Refer to NAS Admin State for a description of possible values.
• Port State	The current state of the port. Refer to NAS Port State for a description of the individual states.
• Last Source	The source MAC address carried in the most recently received EAPOL frame for EAPOL-based authentication, and the most recently received frame from a new client for MAC-based authentication.
• Last ID	The user name (supplicant identity) carried in the most recently received Response Identity EAPOL frame for EAPOL-based authentication, and the source MAC address from the most recently received frame from a new client for MAC-based authentication.

<ul style="list-style-type: none"> • QoS Class 	QoS Class assigned to the port by the RADIUS server if enabled.
<ul style="list-style-type: none"> • Port VLAN ID 	<p>The VLAN ID that NAS has put the port in. The field is blank, if the Port VLAN ID is not overridden by NAS.</p> <ul style="list-style-type: none"> ■ If the VLAN ID is assigned by the RADIUS server, "(RADIUS-assigned)" is appended to the VLAN ID. Read more about RADIUS-assigned VLANs here. ■ If the port is moved to the Guest VLAN, "(Guest)" is appended to the VLAN ID. Read more about Guest VLANs here.

Buttons

Auto-refresh : Check this box to refresh the page automatically. Automatic refresh occurs every 3 seconds.

: Click to refresh the page immediately.

4.11.5 Network Access Statistics

This page provides detailed NAS statistics for a specific switch port running EAPOL-based IEEE 802.1X authentication. For MAC-based ports, it shows selected backend server (RADIUS Authentication Server) statistics, only. Use the port select box to select which port details to be displayed. The Network Access Statistics screen in [Figure 4-11-6](#) appears.

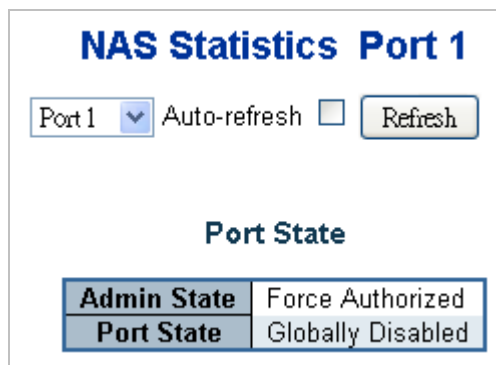

Figure 4-11-6: Network Access Statistics Page Screenshot

The page includes the following fields:

Port State

Object	Description
<ul style="list-style-type: none"> • Admin State 	The port's current administrative state. Refer to NAS Admin State for a description of possible values.
<ul style="list-style-type: none"> • Port State 	The current state of the port. Refer to NAS Port State for a description of the individual states.
<ul style="list-style-type: none"> • QoS Class 	The QoS class assigned by the RADIUS server. The field is blank if no QoS class

	is assigned.
<ul style="list-style-type: none"> • Port VLAN ID 	<p>The VLAN ID that NAS has put the port in. The field is blank, if the Port VLAN ID is not overridden by NAS.</p> <p>If the VLAN ID is assigned by the RADIUS server, "(RADIUS-assigned)" is appended to the VLAN ID. Read more about RADIUS-assigned VLANs here.</p> <p>If the port is moved to the Guest VLAN, "(Guest)" is appended to the VLAN ID. Read more about Guest VLANs here.</p>

Port Counters

Object	Description			
<ul style="list-style-type: none"> • EAPOL Counters 	<p>These supplicant frame counters are available for the following administrative states:</p> <p>Force Authorized</p> <p>Force Unauthorized</p> <p>Port-based 802.1X</p> <p>Single 802.1X</p> <p>Multi 802.1X</p>			
	Direction	Name	IEEE Name	Description
	Rx	Total	dot1xAuthEapolFramesRx	The number of valid EAPOL frames of any type that have been received by the switch.
	Rx	Response ID	dot1xAuthEapolRespIdFramesRx	The number of valid EAPOL Response Identity frames that have been received by the switch.
	Rx	Responses	dot1xAuthEapolRespFramesRx	The number of valid EAPOL response frames (other than Response Identity frames) that have been received by the switch.
	Rx	Start	dot1xAuthEapolStartFramesRx	The number of EAPOL Start frames that have been received by the switch.
Rx	Logoff	dot1xAuthEapolLogoffFramesRx	The number of valid EAPOL Logoff frames that have	

been received by the switch.

Rx	Invalid Type	dot1xAuthInvalidEapolFramesRx	The number of EAPOL frames that have been received by the switch in which the frame type is not recognized.
Rx	Invalid Length	dot1xAuthEapLengthErrorFramesRx	The number of EAPOL frames that have been received by the switch in which the Packet Body Length field is invalid.
Tx	Total	dot1xAuthEapolFramesTx	The number of EAPOL frames of any type that have been transmitted by the switch.
Tx	Request ID	dot1xAuthEapolReqIdFramesTx	The number of EAPOL Request Identity frames that have been transmitted by the switch.
Tx	Requests	dot1xAuthEapolReqFramesTx	The number of valid EAPOL Request frames (other than Request Identity frames) that have been transmitted by the switch.

• **Backend Server Counters**

These backend (RADIUS) frame counters are available for the following administrative states:

- **Port-based 802.1X**
- **Single 802.1X**
- **Multi 802.1X**
- **MAC-based Auth**

Direction	Name	IEEE Name	Description
Rx	Access Challenges	dot1xAuthBackendAccessChallenges	802.1X-based: Counts the number of times that the switch receives the first request from the backend server following the first

			<p>response from the supplicant.</p> <p>Indicates that the backend server has communication with the switch.</p> <p>MAC-based:</p> <p>Counts all Access Challenges received from the backend server for this port (left-most table) or client (right-most table).</p>
Rx	Other Requests	dot1xAuthBackendOtherRequestsToSupplicant	<p>802.1X-based:</p> <p>Counts the number of times that the switch sends an EAP Request packet following the first to the supplicant.</p> <p>Indicates that the backend server chose an EAP-method.</p> <p>MAC-based:</p> <p>Not applicable.</p>
Rx	Auth. Successes	dot1xAuthBackendAuthSuccesses	<p>802.1X- and MAC-based:</p> <p>Counts the number of times that the switch receives a success indication. Indicates that the supplicant/client has successfully authenticated to the backend server.</p>
Rx	Auth. Failures	dot1xAuthBackendAuthFails	<p>802.1X- and MAC-based:</p> <p>Counts the number of times that the switch receives a failure message. This indicates that the supplicant/client has not authenticated to the backend server.</p>
Tx	Responses	dot1xAuthBackendResponses	<p>802.1X-based:</p> <p>Counts the number of times that the switch attempts to send a supplicant's first</p>

response packet to the backend server. Indicates the switch attempted communication with the backend server. Possible retransmissions are not counted.

MAC-based:

Counts all the backend server packets sent from the switch towards the backend server for a given port (left-most table) or client (right-most table). Possible retransmissions are not counted.

• **Last Supplicant/Client Info**

Information about the last supplicant/client that attempted to authenticate. This information is available for the following administrative states:

- **Port-based 802.1X**
- **Single 802.1X**
- **Multi 802.1X**
- **MAC-based Auth.**

Name	IEEE Name	Description
MAC Address	dot1xAuthLastEapolFrameSource	The MAC address of the last supplicant/client.
VLAN ID	-	The VLAN ID on which the last frame from the last supplicant/client was received.
Version	dot1xAuthLastEapolFrameVersion	<p>802.1X-based:</p> <p>The protocol version number carried in the most recently received EAPOL frame.</p> <p>MAC-based:</p> <p>Not applicable.</p>
Identity	-	<p>802.1X-based:</p> <p>The user name (supplicant identity) carried in the most recently received Response Identity EAPOL frame.</p> <p>MAC-based:</p>

	Not applicable.
--	-----------------

Selected Counters

Object	Description
<ul style="list-style-type: none"> Selected Counters 	<p>The Selected Counters table is visible when the port is one of the following administrative states:</p> <ul style="list-style-type: none"> Multi 802.1X MAC-based Auth. <p>The table is identical to and is placed next to the Port Counters table, and will be empty if no MAC address is currently selected. To populate the table, select one of the attached MAC Addresses from the table below.</p>

Attached MAC Address

Object	Description
<ul style="list-style-type: none"> Identity 	<p>Shows the identity of the supplicant, as received in the Response Identity EAPOL frame. Clicking the link causes the supplicant's EAPOL and Backend Server counters to be shown in the Selected Counters table. If no supplicants are attached, it shows No supplicants attached.</p> <p><i>This column is not available for MAC-based Auth.</i></p>
<ul style="list-style-type: none"> MAC Address 	<p>For Multi 802.1X, this column holds the MAC address of the attached supplicant. For MAC-based Auth., this column holds the MAC address of the attached client. Clicking the link causes the client's Backend Server counters to be shown in the Selected Counters table. If no clients are attached, it shows No clients attached.</p>
<ul style="list-style-type: none"> VLAN ID 	<p>This column holds the VLAN ID that the corresponding client is currently secured through the Port Security module.</p>
<ul style="list-style-type: none"> State 	<p>The client can either be authenticated or unauthenticated. In the authenticated state, it is allowed to forward frames on the port, and in the unauthenticated state, it is blocked. As long as the backend server hasn't successfully authenticated the client, it is unauthenticated. If an authentication fails for one or the other reason, the client will remain in the unauthenticated state for Hold Time seconds.</p>
<ul style="list-style-type: none"> Last Authentication 	<p>Shows the date and time of the last authentication of the client (successful as well as unsuccessful).</p>

Buttons

Auto-refresh : Check this box to refresh the page automatically. Automatic refresh occurs every 3 seconds.

Refresh: Click to refresh the page immediately.

Clear: This button is available in the following modes:

- Force Authorized
- Force Unauthorized
- Port-based 802.1X
- Single 802.1X

Click to clear the counters for the selected port.

Clear All: This button is available in the following modes:

- Multi 802.1X
- MAC-based Auth.X

Click to clear both the port counters and all of the attached client's counters. The "Last Client" will not be cleared, however.

Clear This: This button is available in the following modes:

- Multi 802.1X
- MAC-based Auth.X

Click to clear only the currently selected client's counters.

4.11.6 Authentication Server Configuration

This page allows you to configure the Authentication Servers. The Authentication Server Configuration screen in [Figure 4-11-7](#) appears.

Authentication Server Configuration

Common Server Configuration

Timeout	15	seconds
Dead Time	300	seconds

RADIUS Authentication Server Configuration

#	Enabled	IP Address/Hostname	Port	Secret
1	<input type="checkbox"/>		1812	
2	<input type="checkbox"/>		1812	
3	<input type="checkbox"/>		1812	
4	<input type="checkbox"/>		1812	
5	<input type="checkbox"/>		1812	

RADIUS Accounting Server Configuration

#	Enabled	IP Address/Hostname	Port	Secret
1	<input type="checkbox"/>		1813	
2	<input type="checkbox"/>		1813	
3	<input type="checkbox"/>		1813	
4	<input type="checkbox"/>		1813	
5	<input type="checkbox"/>		1813	

TACACS+ Authentication Server Configuration

#	Enabled	IP Address/Hostname	Port	Secret
1	<input type="checkbox"/>		49	
2	<input type="checkbox"/>		49	
3	<input type="checkbox"/>		49	
4	<input type="checkbox"/>		49	
5	<input type="checkbox"/>		49	

Figure 4-11-7: Authentication Server Configuration Page Screenshot

The page includes the following fields:

Port State

These settings are common for all of the Authentication Servers.

Object	Description
<ul style="list-style-type: none"> • Timeout 	<p>The Timeout, which can be set to a number between 3 and 3600 seconds, is the maximum time to wait for a reply from a server.</p> <p>If the server does not reply within this timeframe, we will consider it to be dead and continue with the next enabled server (if any).</p> <p>RADIUS servers are using the UDP protocol, which is unreliable by design. In order to cope with lost frames, the timeout interval is divided into 3 subintervals of equal length. If a reply is not received within the subinterval, the request is transmitted again. This algorithm causes the RADIUS server to be queried up to 3 times before it is considered to be dead.</p>
<ul style="list-style-type: none"> • Dead Time 	<p>The Dead Time, which can be set to a number between 0 and 3600 seconds, is the period during which the switch will not send new requests to a server that has failed to respond to a previous request. This will stop the switch from continually trying to contact a server that it has already determined as dead.</p> <p>Setting the Dead Time to a value greater than 0 (zero) will enable this feature, but only if more than one server has been configured.</p>

RADIUS Authentication Server Configuration

The table has one row for each RADIUS Authentication Server and a number of columns, which are:

Object	Description
<ul style="list-style-type: none"> • # 	The RADIUS Authentication Server number for which the configuration below applies.
<ul style="list-style-type: none"> • Enabled 	Enable the RADIUS Authentication Server by checking this box.
<ul style="list-style-type: none"> • IP Address/Hostname 	The IP address or hostname of the RADIUS Authentication Server. IP address is expressed in dotted decimal notation.
<ul style="list-style-type: none"> • Port 	The UDP port to use on the RADIUS Authentication Server. If the port is set to 0 (zero), the default port (1812) is used on the RADIUS Authentication Server.
<ul style="list-style-type: none"> • Secret 	The secret - up to 29 characters long - shared between the RADIUS Authentication Server and the switch.

RADIUS Accounting Server Configuration

The table has one row for each RADIUS Accounting Server and a number of columns, which are:

Object	Description
• #	The RADIUS Accounting Server number for which the configuration below applies.
• Enabled	Enable the RADIUS Accounting Server by checking this box.
• IP Address/Hostname	The IP address or hostname of the RADIUS Accounting Server. IP address is expressed in dotted decimal notation.
• Port	The UDP port to use on the RADIUS Accounting Server. If the port is set to 0 (zero), the default port (1813) is used on the RADIUS Accounting Server.
• Secret	The secret - up to 29 characters long - shared between the RADIUS Accounting Server and the switch.

TACACS+ Authentication Server Configuration

The table has one row for each TACACS+ Authentication Server and a number of columns, which are:

Object	Description
• #	The TACACS+ Authentication Server number for which the configuration below applies.
• Enabled	Enable the TACACS+ Authentication Server by checking this box.
• IP Address/Hostname	The IP address or hostname of the TACACS+ Authentication Server. IP address is expressed in dotted decimal notation.
• Port	The TCP port to use on the TACACS+ Authentication Server. If the port is set to 0 (zero), the default port (49) is used on the TACACS+ Authentication Server.
• Secret	The secret - up to 29 characters long - shared between the TACACS+ Authentication Server and the switch.

Buttons

: Click to save changes.

: Click to undo any changes made locally and revert to previously saved values.

4.11.7 RADIUS Overview

This page provides an overview of the status of the RADIUS servers configurable on the Authentication configuration page. The RADIUS Authentication/Accounting Server Overview screen in [Figure 4-11-8](#) appears.

RADIUS Authentication Server Status Overview

#	IP Address	Status
1	0.0.0.0:1812	Disable
2	0.0.0.0:1812	Disable
3	0.0.0.0:1812	Disable
4	0.0.0.0:1812	Disable
5	0.0.0.0:1812	Disable

RADIUS Accounting Server Status Overview

#	IP Address	Status
1	0.0.0.0:1813	Disable
2	0.0.0.0:1813	Disable
3	0.0.0.0:1813	Disable
4	0.0.0.0:1813	Disable
5	0.0.0.0:1813	Disable

Auto Refresh

Figure 4-11-8: RADIUS Authentication/Accounting Server Overview Page Screenshot

The page includes the following fields:

RADIUS Authentication Server

Object	Description
• #	The RADIUS server number. Click to navigate to detailed statistics for this server.
• IP Address	The IP address and UDP port number (in <IP Address>:<UDP Port> notation) of this server.
• Status	<p>The current state of the server. This field takes one of the following values:</p> <ul style="list-style-type: none"> ■ Disabled: The server is disabled. ■ Not Ready: The server is enabled, but IP communication is not yet up and running. ■ Ready: The server is enabled, IP communication is up and running, and the RADIUS module is ready to accept access attempts. ■ Dead (X seconds left): Access attempts were made to this server, but it did not reply within the configured timeout. The server has temporarily been disabled, but will get re-enabled when the dead-time expires. The number of seconds left before this occurs is displayed in

	parentheses. This state is only reachable when more than one server is enabled.
--	---

RADIUS Accounting Server

Object	Description
<ul style="list-style-type: none"> • # 	The RADIUS server number. Click to navigate to detailed statistics for this server.
<ul style="list-style-type: none"> • IP Address 	The IP address and UDP port number (in <IP Address>:<UDP Port> notation) of this server.
<ul style="list-style-type: none"> • Status 	<p>The current state of the server. This field takes one of the following values:</p> <ul style="list-style-type: none"> ■ Disabled: The server is disabled. ■ Not Ready: The server is enabled, but IP communication is not yet up and running. ■ Ready: The server is enabled, IP communication is up and running, and the RADIUS module is ready to accept accounting attempts. ■ Dead (X seconds left): Accounting attempts were made to this server, but it did not reply within the configured timeout. The server has temporarily been disabled, but will get re-enabled when the dead-time expires. The number of seconds left before this occurs is displayed in parentheses. This state is only reachable when more than one server is enabled.

Buttons

Auto-refresh : Check this box to refresh the page automatically. Automatic refresh occurs every 3 seconds.

: Click to refresh the page immediately.

4.11.8 RADIUS Details

This page provides detailed statistics for a particular RADIUS server. The RADIUS Authentication/Accounting for Server Overview screen in [Figure 4-11-9](#) appears.

RADIUS Authentication Statistics for Server #1

Server #1 ▼

Receive Packets		Transmit Packets	
Access Accepts	0	Access Requests	0
Access Rejects	0	Access Retransmissions	0
Access Challenges	0	Pending Requests	0
Malformed Access Responses	0	Timeouts	0
Bad Authenticators	0		
Unknown Types	0		
Packets Dropped	0		
Other Info			
IP Address		0.0.0.0:1812	
State		Disabled	
Round-Trip Time		0 ms	

RADIUS Accounting Statistics for Server #1

Receive Packets		Transmit Packets	
Responses	0	Requests	0
Malformed Responses	0	Retransmissions	0
Bad Authenticators	0	Pending Requests	0
Unknown Types	0	Timeouts	0
Packets Dropped	0		
Other Info			
IP Address		0.0.0.0:1813	
State		Disabled	
Round-Trip Time		0 ms	

Auto-refresh Refresh Clear

Figure 4-11-9: RADIUS Authentication/Accounting for Server Overview Page Screenshot

The page includes the following fields:

RADIUS Authentication Servers

The statistics map closely to those specified in RFC4668 - RADIUS Authentication Client MIB.

Use the server select box to switch between the backend servers to show details for.

Object	Description								
<ul style="list-style-type: none"> Packet Counters 	<p>RADIUS authentication server packet counter. There are seven receive and four transmit counters.</p> <table border="1"> <thead> <tr> <th>Direction</th> <th>Name</th> <th>RFC4668 Name</th> <th>Description</th> </tr> </thead> <tbody> <tr> <td>Rx</td> <td>Access</td> <td>radiusAuthClientExtA</td> <td>The number of RADIUS Access-Accept packets (valid</td> </tr> </tbody> </table>	Direction	Name	RFC4668 Name	Description	Rx	Access	radiusAuthClientExtA	The number of RADIUS Access-Accept packets (valid
Direction	Name	RFC4668 Name	Description						
Rx	Access	radiusAuthClientExtA	The number of RADIUS Access-Accept packets (valid						

	Accepts	radiusAuthClientExtAccessAccepts	The number of RADIUS packets (valid or invalid) received from the server.
Rx	Access Rejects	radiusAuthClientExtAccessRejects	The number of RADIUS Access-Reject packets (valid or invalid) received from the server.
Rx	Access Challenges	radiusAuthClientExtAccessChallenges	The number of RADIUS Access-Challenge packets (valid or invalid) received from the server.
Rx	Malformed Access Responses	radiusAuthClientExtMalformedAccessResponses	The number of malformed RADIUS Access-Response packets received from the server. Malformed packets include packets with an invalid length. Bad authenticators or Message Authenticator attributes or unknown types are not included as malformed access responses.
Rx	Bad Authenticators	radiusAuthClientExtBadAuthenticators	The number of RADIUS Access-Response packets containing invalid authenticators or Message Authenticator attributes received from the server.
Rx	Unknown Types	radiusAuthClientExtUnknownTypes	The number of RADIUS packets that were received from the server on the authentication port and dropped for some other reason.
Rx	Packets Dropped	radiusAuthClientExtPacketsDropped	The number of RADIUS packets that were received from the server on the authentication port and dropped for some other

reason.

Tx	Access Requests	radiusAuthClientExtAccessRequests	The number of RADIUS Access-Request packets sent to the server. This does not include retransmissions.
Tx	Access Retransmissions	radiusAuthClientExtAccessRetransmissions	The number of RADIUS Access-Request packets retransmitted to the RADIUS authentication server.
Tx	Pending Requests	radiusAuthClientExtPendingRequests	The number of RADIUS Access-Request packets destined for the server that have not yet timed out or received a response. This variable is incremented when an Access-Request is sent and decremented due to receipt of an Access-Accept, Access-Reject, Access-Challenge, timeout, or retransmission.
Tx	Timeouts	radiusAuthClientExtTimeouts	The number of authentication timeouts to the server. After a timeout, the client may retry to the same server, send to a different server, or give up. A retry to the same server is counted as a retransmit as well as a timeout. A send to a different server is counted as a Request as well as a timeout.

• **Other Info**

This section contains information about the state of the server and the latest round-trip time.

Name	RFC4668 Name	Description
IP Address	-	IP address and UDP port for the accounting server in question.

	State	-	<p>Shows the state of the server. It takes one of the following values:</p> <p>Disabled: The selected server is disabled.</p> <p>Not Ready: The server is enabled, but IP communication is not yet up and running.</p> <p>Ready: The server is enabled, IP communication is up and running, and the RADIUS module is ready to accept access attempts.</p> <p>Dead (X seconds left): Access attempts were made to this server, but it did not reply within the configured timeout. The server has temporarily been disabled, but will get re-enabled when the dead-time expires. The number of seconds left before this occurs is displayed in parentheses. This state is only reachable when more than one server is enabled.</p>
	Round-Trip Time	radiusAuthClient ExtRoundTripTime	<p>The time interval (measured in milliseconds) between the most recent Access-Reply/Access-Challenge and the Access-Request that matched it from the RADIUS authentication server. The granularity of this measurement is 100 ms. A value of 0 ms indicates that there hasn't been round-trip communication with the server yet.</p>

RADIUS Accounting Servers

The statistics map closely to those specified in RFC4670 - RADIUS Accounting Client MIB.

Use the server select box to switch between the backend servers to show details for.

Object	Description			
<ul style="list-style-type: none"> Packet Counters 	RADIUS accounting server packet counter. There are five receive and four transmit counters.			
	Direction	Name	RFC4670 Name	Description
	Rx	Responses	radiusAccClientExt Responses	The number of RADIUS packets (valid or invalid) received from the server.
	Rx	Malformed Responses	radiusAccClientExt MalformedResponses	The number of malformed RADIUS packets received from the server. Malformed packets include packets with an invalid length. Bad authenticators or unknown types are not included as malformed access responses.
	Rx	Bad Authenticators	radiusAccClientExt BadAuthenticators	The number of RADIUS packets containing invalid authenticators received from the server.
	Rx	Unknown Types	radiusAccClientExt UnknownTypes	The number of RADIUS packets of unknown types that were received from the server on the accounting port.
	Rx	Packets Dropped	radiusAccClientExt PacketsDropped	The number of RADIUS packets that were received from the server on the accounting port and dropped for some other reason.
Tx	Requests	radiusAccClientExt Requests	The number of RADIUS packets sent to the server. This does not include retransmissions.	

	Tx	Retransmissions	radiusAccClientExt Retransmissions	The number of RADIUS packets retransmitted to the RADIUS accounting server.
	Tx	Pending Requests	radiusAccClientExt PendingRequests	The number of RADIUS packets destined for the server that have not yet timed out or received a response. This variable is incremented when a Request is sent and decremented due to receipt of a Response, timeout, or retransmission.
	Tx	Timeouts	radiusAccClientExt Timeouts	The number of accounting timeouts to the server. After a timeout, the client may retry to the same server, send to a different server, or give up. A retry to the same server is counted as a retransmit as well as a timeout. A send to a different server is counted as a Request as well as a timeout.

• **Other Info**

This section contains information about the state of the server and the latest round-trip time.

Name	RFC4670 Name	Description
IP Address	-	IP address and UDP port for the accounting server in question.
State	-	Shows the state of the server. It takes one of the following values: Disabled: The selected server is disabled. Not Ready: The server is enabled, but IP communication is not yet up and running. Ready: The server is enabled, IP communication is up and running, and the RADIUS module is ready to accept accounting attempts. Dead (X seconds left): Accounting attempts

were made to this server, but it did not reply within the configured timeout. The server has temporarily been disabled, but will get re-enabled when the dead-time expires. The number of seconds left before this occurs is displayed in parentheses. This state is only reachable when more than one server is enabled.

Round-Trip Time	radiusAccClientExtRoundTripTime	The time interval (measured in milliseconds) between the most recent Response and the Request that matched it from the RADIUS accounting server. The granularity of this measurement is 100 ms. A value of 0 ms indicates that there hasn't been round-trip communication with the server yet.
------------------------	---------------------------------	--

Buttons

Auto-refresh : Check this box to refresh the page automatically. Automatic refresh occurs every 3 seconds.

: Click to refresh the page immediately.

: Clears the counters for the selected server. The "Pending Requests" counter will not be cleared by this operation.

4.11.9 Windows Platform RADIUS Server Configuration

Setup the RADIUS server and assign the client IP address to the Managed switch. In this case, field in the default IP Address of the Managed Switch with 192.168.0.100. And also make sure the shared **secret key** is as same as the one you had set at the Managed Switch's 802.1x system configuration – **12345678** at this case.

1. Configure the IP Address of remote RADIUS server and secret key.

Authentication Server Configuration

Common Server Configuration

Timeout	15	seconds
Dead Time	300	seconds

RADIUS Authentication Server Configuration

#	Enabled	IP Address/Hostname	Port	Secret
1	<input checked="" type="checkbox"/>	192.168.0.253	1812	●●●●●●●●
2	<input type="checkbox"/>		1812	
3	<input type="checkbox"/>		1812	
4	<input type="checkbox"/>		1812	
5	<input type="checkbox"/>		1812	

Figure 4-11-10: RADIUS Server Configuration Screenshot

2. Add New RADIUS Client on the Windows 2003 server

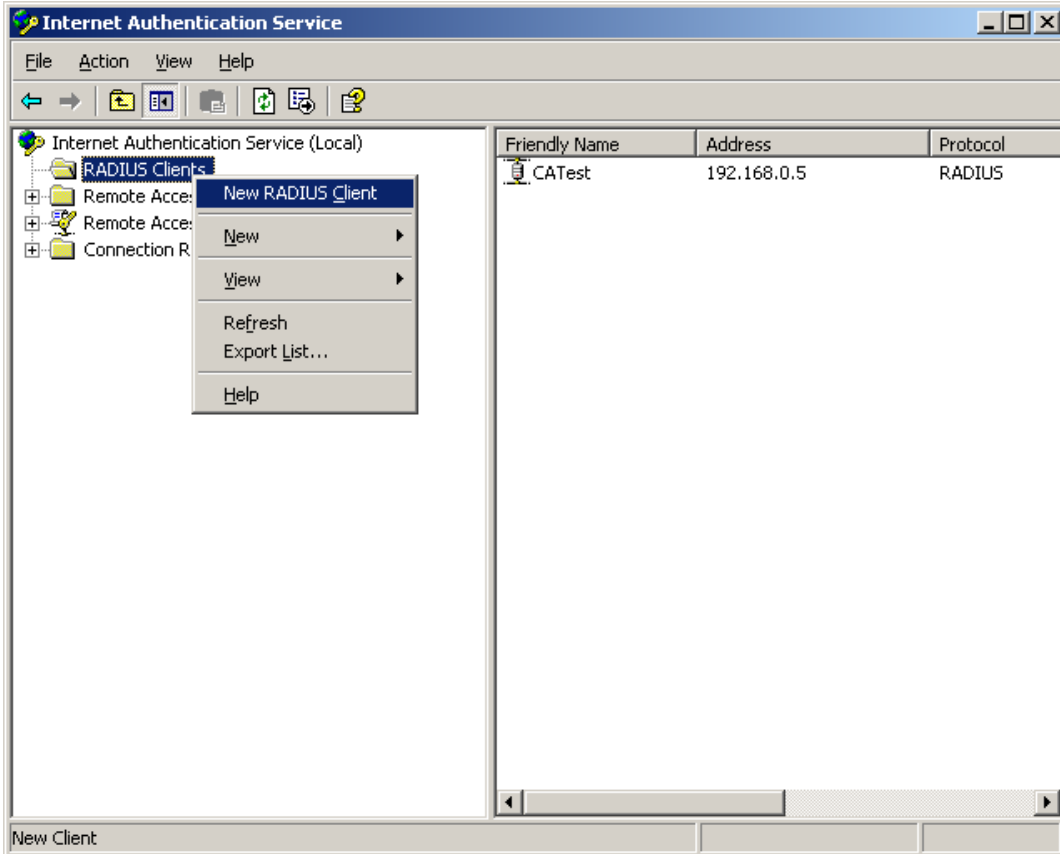

Figure 4-11-11: Windows Server – Add New RADIUS Client Setting

3. Assign the client IP address to the **Industrial Managed Switch**.

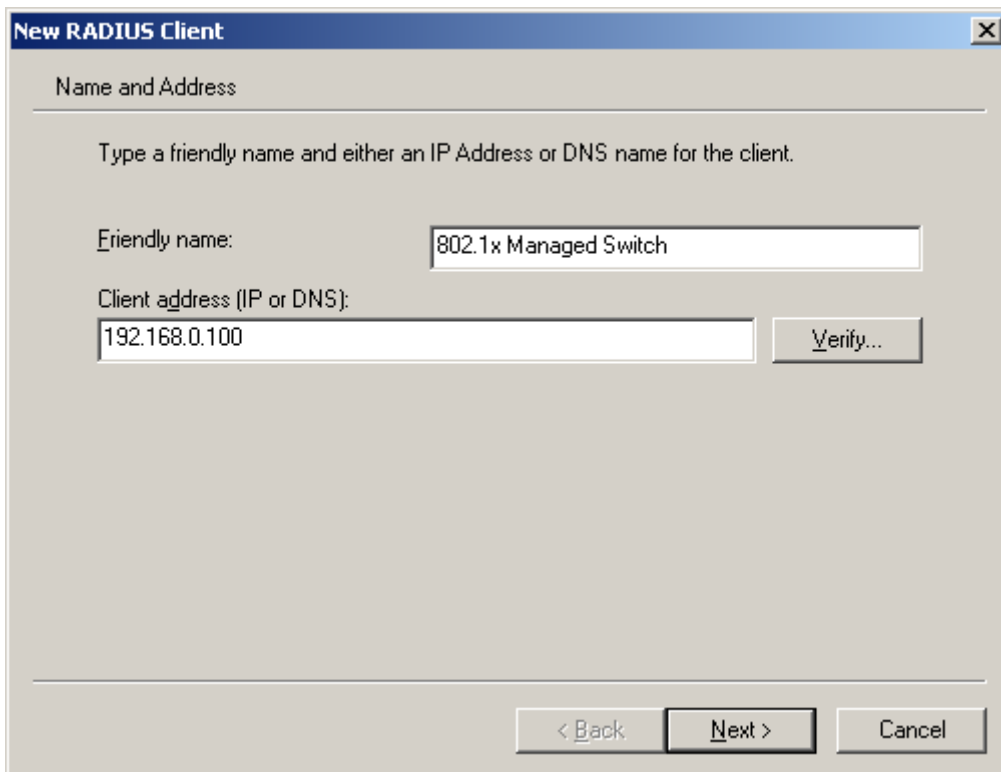

Figure 4-11-12: Windows Server RADIUS Server Setting

4. The shared **secret key** should be as same as the key configured on the **Industrial Managed Switch**.

New RADIUS Client

Additional Information

If you are using remote access policies based on the client vendor attribute, specify the vendor of the RADIUS client.

Client-Vendor: RADIUS Standard

Shared secret: *****

Confirm shared secret: *****

Request must contain the Message Authenticator attribute

< Back Finish Cancel

Figure 4-11-13: Windows Server RADIUS Server Setting

- Configure ports attribute of 802.1X, the same as "802.1X Port Configuration".

Port	Admin State	RADIUS- Assigned QoS Enabled	RADIUS- Assigned VLAN Enabled	Guest VLAN Enabled	Port State	Restart
*	<<Configure All>>	<input type="checkbox"/>	<input type="checkbox"/>	<input type="checkbox"/>		
1	Port-based 802.1X	<input type="checkbox"/>	<input type="checkbox"/>	<input type="checkbox"/>	Globally Disabled	Reauthenticate Reinitialize
2	Port-based 802.1X	<input type="checkbox"/>	<input type="checkbox"/>	<input type="checkbox"/>	Globally Disabled	Reauthenticate Reinitialize

Figure 4-11-14: 802.1x Port Configuration

- Create user data. The establishment of the user data needs to be created on the Radius Server PC. For example, the Radius Server founded on Win2003 Server, and then:

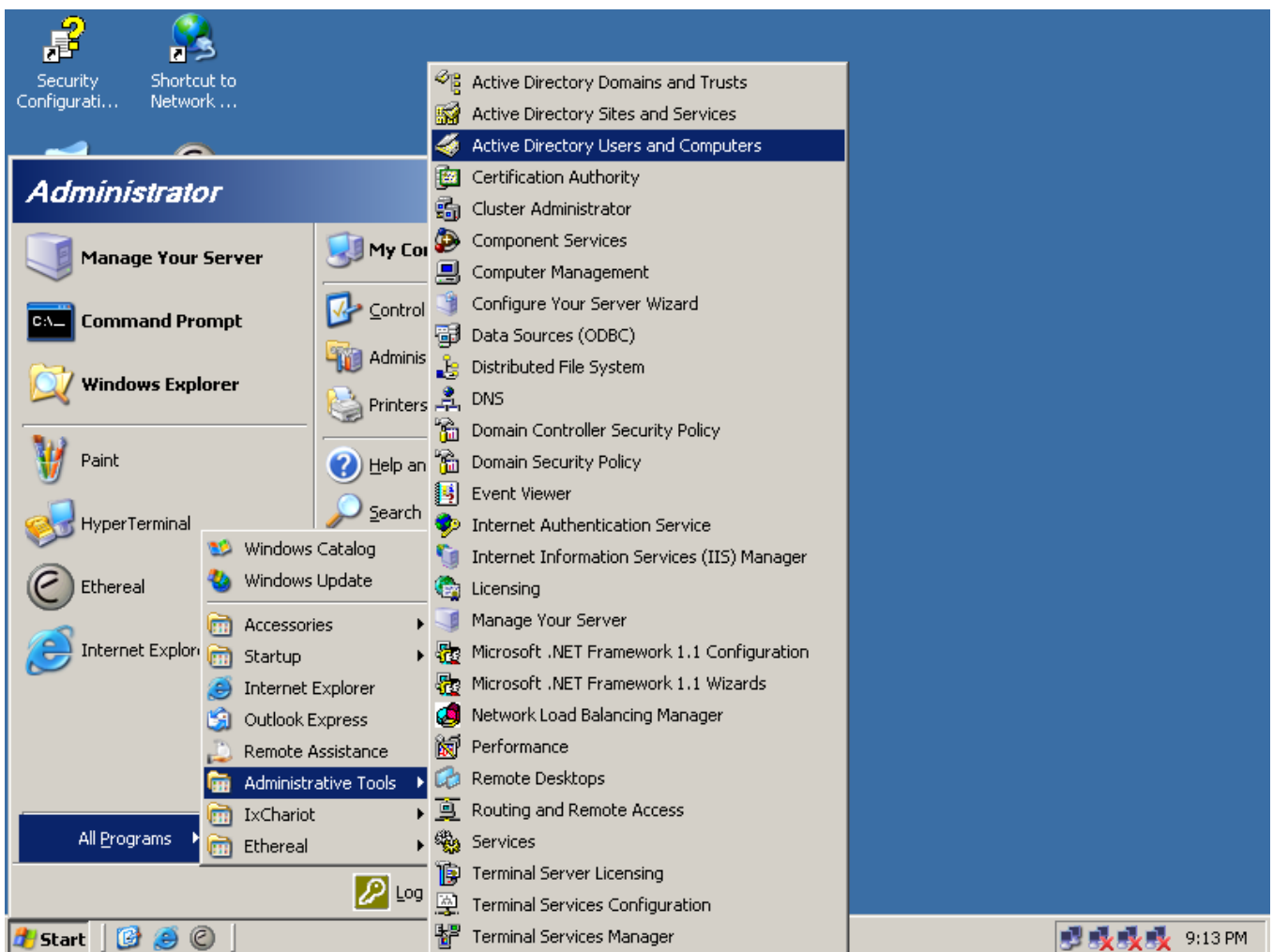

Figure 4-11-15: Windows 2003 AD Server Setting Path

7. Enter "Active Directory Users and Computers", create legal user data, the next, right-click a user what you created to enter properties, and what to be noticed:

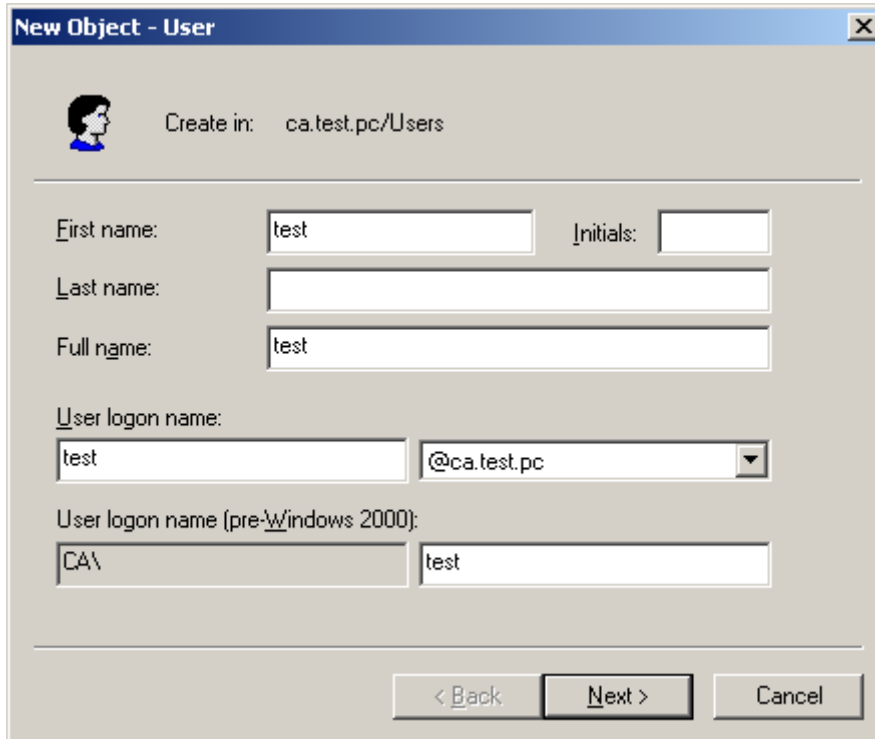

Figure 4-11-16: Add User Properties Screen

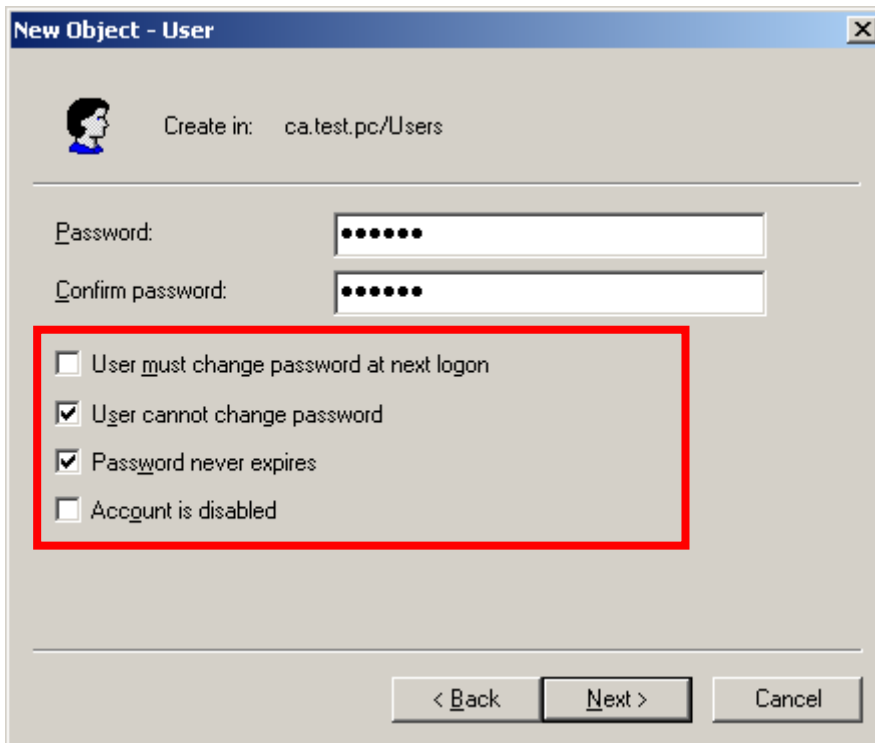

Figure 4-11-17: Add User Properties Screen



Set the Ports Authenticate Status to **“Force Authorized”** if the port is connected to the RADIUS server or the port is a uplink port that is connected to another switch. Or once the 802.1X is set to work, the switch might not be able to access the RADIUS server.

4.11.10 802.1X Client Configuration

Windows XP is originally 802.1X support. As to other operating systems (windows 98SE, ME, 2000), an 802.1X client utility is needed. The following procedures show how to configure 802.1X Authentication in Windows XP.

Please note that if you want to change the 802.1x authentication type of a wireless client, i.e. switch to EAP-TLS from EAP-MD5, you must remove the current existing wireless network from your preferred connection first, and add it in again.

■ Configure Sample: EAP-MD5 Authentication

1. Go to **Start > Control Panel**, double-click on **“Network Connections”**.
2. Right-click on the Local Network Connection.
3. Click **“Properties”** to open up the Properties setting window.

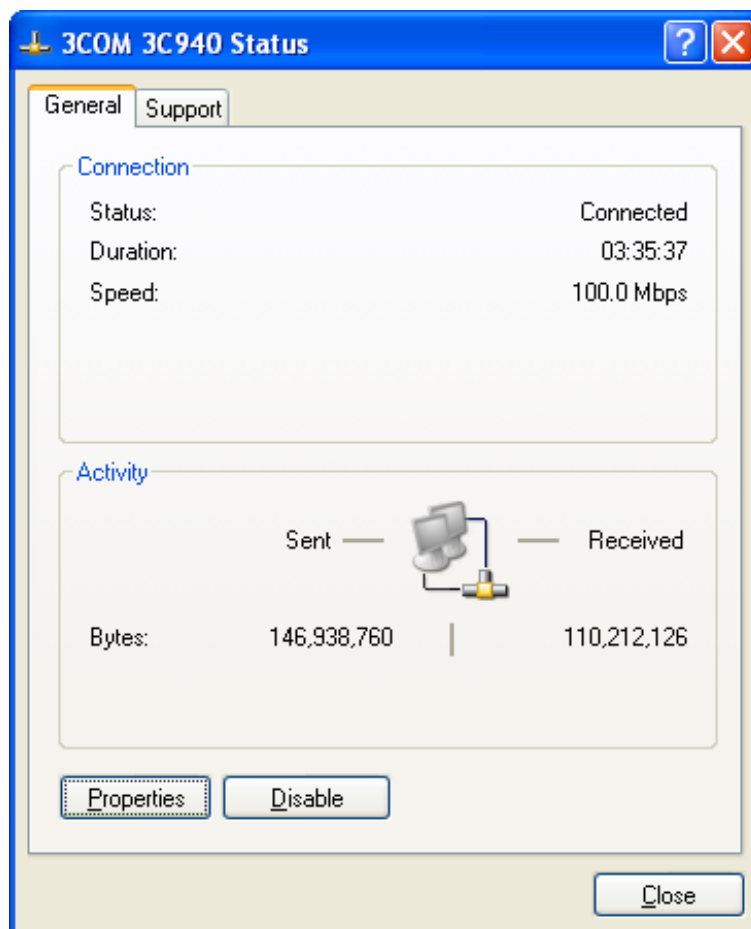

Figure 4-11-18

4. Select "**Authentication**" tab.
5. Select "**Enable network access control using IEEE 802.1X**" to enable 802.1x authentication.
6. Select "**MD-5 Challenge**" from the drop-down list box for EAP type.

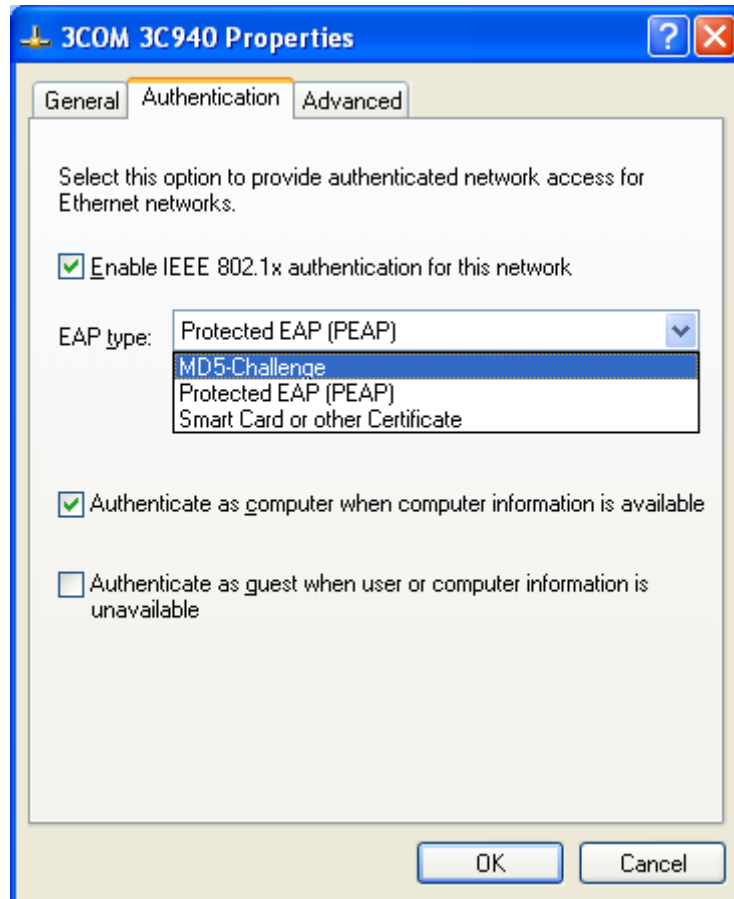

Figure 4-11-19

7. Click "**OK**".
8. When client has associated with the Managed Switch, a user authentication notice appears in system tray. Click on the notice to continue.



Figure 4-11-20: Windows Client Popup Login Request Message

9. Enter the user name, password and the logon domain that your account belongs.
10. Click "OK" to complete the validation process.



Figure 4-11-21

4.12 Security

This section is to control the access of the Industrial Managed Switch, including the user access and management control.

The Security page contains links to the following main topics:

- **Port Limit Control**
- **Access Management**
- **Access Management Statistics**
- **HTTPs**
- **SSH**
- **Port Security Status**
- **Port Security Detail**
- **DHCP Snooping**
- **DHCP Snooping Statistics**
- **IP Source Guard Configuration**
- **IP Source Guard Static Table**
- **ARP Inspection**
- **ARP Inspection Static Table**

4.12.1 Port Limit Control

This page allows you to configure the Port Security Limit Control system and port settings. Limit Control allows for limiting the number of users on a given port. A user is identified by a MAC address and VLAN ID. If Limit Control is enabled on a port, the limit specifies the maximum number of users on the port. If this number is exceeded, an action is taken. The action can be one of the four different actions as described below.

The Limit Control module utilizes a lower-layer module and Port Security module, which manages MAC addresses learnt on the port. The Limit Control configuration consists of two sections, a system and a port.

The Port Limit Control Configuration screen in [Figure 4-12-1](#) appears.

Port Security Limit Control Configuration

System Configuration

Mode	Disabled ▾
Aging Enabled	<input type="checkbox"/>
Aging Period	3600 seconds

Port Configuration

Port	Mode	Limit	Action	State	Re-open
*	<All> ▾	4	<All> ▾		
1	Disabled ▾	4	None ▾	Disabled	Reopen
2	Disabled ▾	4	None ▾	Disabled	Reopen
3	Disabled ▾	4	None ▾	Disabled	Reopen
4	Disabled ▾	4	None ▾	Disabled	Reopen
5	Disabled ▾	4	None ▾	Disabled	Reopen
6	Disabled ▾	4	None ▾	Disabled	Reopen
7	Disabled ▾	4	None ▾	Disabled	Reopen
8	Disabled ▾	4	None ▾	Disabled	Reopen
9	Disabled ▾	4	None ▾	Disabled	Reopen
10	Disabled ▾	4	None ▾	Disabled	Reopen

Figure 4-12-1: Port Limit Control Configuration Overview Page Screenshot

The page includes the following fields:

System Configuration

Object	Description
<ul style="list-style-type: none"> Mode 	Indicates if Limit Control is globally enabled or disabled on the switchstack. If globally disabled, other modules may still use the underlying functionality, but limit checks and corresponding actions are disabled.
<ul style="list-style-type: none"> Aging Enabled 	If checked, secured MAC addresses are subject to aging as discussed under Aging Period.
<ul style="list-style-type: none"> Aging Period 	<p>If Aging Enabled is checked, then the aging period is controlled with this input. If other modules are using the underlying port security for securing MAC addresses, they may have other requirements to the aging period. The underlying port security will use the shorter requested aging period of all modules that use the functionality.</p> <p>The Aging Period can be set to a number between 10 and 10,000,000 seconds.</p>

	<p>To understand why aging may be desired, consider the following scenario:</p> <p>Suppose an end-host is connected to a 3rd party switch or hub, which in turn is connected to a port on this switch on which Limit Control is enabled. The end-host will be allowed to forward if the limit is not exceeded. Now suppose that the end-host logs off or powers down. If it wasn't for aging, the end-host would still take up resources on this switch and will be allowed to forward. To overcome this situation, enable aging. With aging enabled, a timer is started once the end-host gets secured. When the timer expires, the switch starts looking for frames from the end-host, and if such frames are not seen within the next Aging Period, the end-host is assumed to be disconnected, and the corresponding resources are freed on the switch.</p>
--	---

Port Configuration

The table has one row for each port on the selected switch in the stack and a number of columns, which are:

Object	Description
<ul style="list-style-type: none"> • Port 	<p>The port number for which the configuration below applies.</p>
<ul style="list-style-type: none"> • Mode 	<p>The Configuration All with available options will assign to whole ports. Controls whether Limit Control is enabled on this port. Both this and the Global Mode must be set to Enabled for Limit Control to be in effect. Notice that other modules may still use the underlying port security features without enabling Limit Control on a given port.</p>
<ul style="list-style-type: none"> • Limit 	<p>The maximum number of MAC addresses that can be secured on this port. This number cannot exceed 1024. If the limit is exceeded, the corresponding action is taken.</p> <p>The stackswitch is "born" with a total number of MAC addresses from which all ports draw whenever a new MAC address is seen on a Port Security-enabled port. Since all ports draw from the same pool, it may happen that a configured maximum cannot be granted, if the remaining ports have already used all available MAC addresses.</p>
<ul style="list-style-type: none"> • Action 	<p>The Configuration All with available options will assign to whole ports.</p> <p>If Limit is reached, the switch can take one of the following actions:</p> <p>None: Do not allow more than Limit MAC addresses on the port, but take no further action.</p> <p>Trap: If Limit + 1 MAC addresses is seen on the port, send an SNMP trap. If Aging is disabled, only one SNMP trap will be sent, but with Aging enabled, new SNMP traps will be sent everytime the limit gets exceeded.</p> <p>Shutdown: If Limit + 1 MAC addresses is seen on the port, shut down the port.</p>

	<p>This implies that all secured MAC addresses will be removed from the port, and no new will be learned. Even if the link is physically disconnected and reconnected on the port (by disconnecting the cable), the port will remain shut down. There are three ways to re-open the port:</p> <ol style="list-style-type: none"> 1) Boot the stack or elect a new masterthe switch, 2) Disable and re-enable Limit Control on the port or the stackswitch, 3) Click the Reopen button. <p>Trap & Shutdown: If Limit + 1 MAC addresses is seen on the port, both the "Trap" and the "Shutdown" actions described above will be taken.</p>
<ul style="list-style-type: none"> • State 	<p>This column shows the current state of the port as seen from the Limit Control's point of view. The state takes one of four values:</p> <p>Disabled: Limit Control is either globally disabled or disabled on the port.</p> <p>Ready: The limit is not yet reached. This can be shown for all actions.</p> <p>Limit Reached: Indicates that the limit is reached on this port. This state can only be shown if Action is set to None or Trap.</p> <p>Shutdown: Indicates that the port is shut down by the Limit Control module. This state can only be shown if Action is set to Shutdown or Trap & Shutdown.</p>
<ul style="list-style-type: none"> • Reopen Button 	<p>If a port is shutdown by this module, you may reopen it by clicking this button, which will only be enabled if this is the case. For other methods, refer to Shutdown in the Action section.</p> <p>Note, that clicking the reopen button causes the page to be refreshed, so non-committed changes will be lost.</p>

Buttons

: Click to save changes.

: Click to undo any changes made locally and revert to previously saved values.

: Click to refresh the page. Note that non-committed changes will be lost.

4.12.2 Access Management

Configure access management table on this page. The maximum entry number is 16. If the application's type match any one of the access management entries, it will allow access to the switch. The Access Management Configuration screen in [Figure 4-12-2](#) appears.

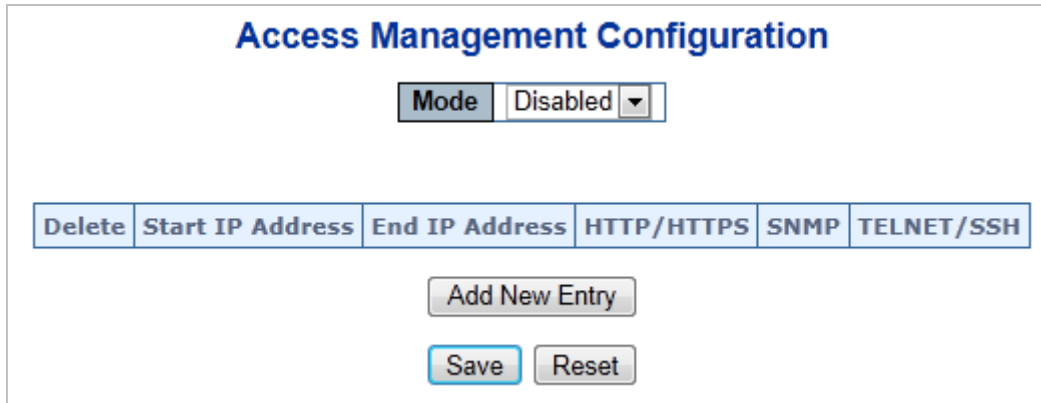
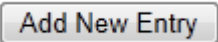



Figure 4-12-2: Access Management Configuration Overview Page Screenshot

The page includes the following fields:

Object	Description
<ul style="list-style-type: none"> Mode 	Indicates the access management mode operation. Possible modes are: <ul style="list-style-type: none"> ■ Enabled: Enable access management mode operation. ■ Disabled: Disable access management mode operation.
<ul style="list-style-type: none"> Delete 	Check to delete the entry. It will be deleted during the next save.
<ul style="list-style-type: none"> Start IP Address 	Indicates the start IP address for the access management entry.
<ul style="list-style-type: none"> End IP Address 	Indicates the end IP address for the access management entry.
<ul style="list-style-type: none"> HTTP/HTTPS 	Indicates the host can access the switch from HTTP/HTTPS interface that the host IP address matched the entry.
<ul style="list-style-type: none"> SNMP 	Indicates the host can access the switch from SNMP interface that the host IP address matched the entry.
<ul style="list-style-type: none"> TELNET/SSH 	Indicates the host can access the switch from TELNET/SSH interface that the host IP address matched the entry.

Buttons

 : Click to add a new access management entry.

 : Click to save changes.

 : Click to undo any changes made locally and revert to previously saved values.

4.12.3 Access Management Statistics

This page provides statistics for access management. The Access Management Statistics screen in [Figure 4-12-3](#) appears.

Access Management Statistics

Interface	Received Packets	Allowed Packets	Discarded Packets
HTTP	0	0	0
HTTPS	0	0	0
SNMP	0	0	0
TELNET	0	0	0
SSH	0	0	0

Auto-refresh

Figure 4-12-3: Access Management Statistics Overview Page Screenshot

The page includes the following fields:

Object	Description
• Interface	The interface that allowed remote host can access the Industrial Managed Switch .
• Receive Packets	The received packets number from the interface under access management mode is enabled.
• Allowed Packets	The allowed packets number from the interface under access management mode is enabled.
• Discard Packets	The discarded packets number from the interface under access management mode is enabled.

Buttons

Auto-refresh : Check this box to refresh the page automatically. Automatic refresh occurs every 3 seconds.

: Click to refresh the page immediately.

: Clear all statistics.

4.12.4 HTTPs

Configure HTTPs on this page. The HTTPs Configuration screen in [Figure 4-12-4](#) appears.

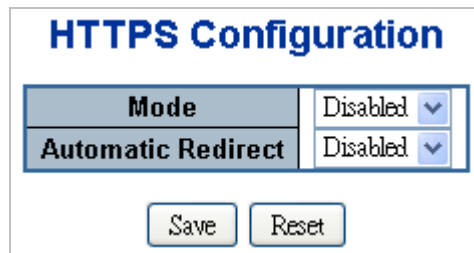

Figure 4-12-4: HTTPs Configuration Screen Page Screenshot

The page includes the following fields:

Object	Description
<ul style="list-style-type: none"> • Mode 	Indicates the HTTPs mode operation. Possible modes are: <ul style="list-style-type: none"> ■ Enabled: Enable HTTPs mode operation. ■ Disabled: Disable HTTPs mode operation.
<ul style="list-style-type: none"> • Automatic Redirect 	Indicates the HTTPs redirect mode operation. Automatic redirect web browser to HTTPs during HTTPs mode enabled. Possible modes are: <ul style="list-style-type: none"> ■ Enabled: Enable HTTPs redirect mode operation. ■ Disabled: Disable HTTPs redirect mode operation.

Buttons

: Click to save changes.

: Click to undo any changes made locally and revert to previously saved values.

4.12.5 SSH

Configure SSH on this page. This page shows the Port Security status. Port Security is a module with no direct configuration. Configuration comes indirectly from other modules - the user modules. When a user module has enabled port security on a port, the port is set-up for software-based learning. In this mode, frames from unknown MAC addresses are passed on to the port security module, which in turn asks all user modules whether to allow this new MAC address to forward or block it. For a MAC address to be set in the forwarding state, all enabled user modules must unanimously agree on allowing the MAC address to forward. If only one chooses to block it, it will be blocked until that user module decides otherwise.

The status page is divided into two sections - one with a legend of user modules and one with the actual port status. The SSH Configuration screen in [Figure 4-12-5](#) appears.

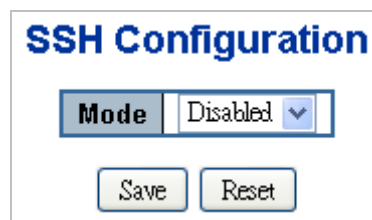

Figure 4-12-5: SSH Configuration Screen Page Screenshot

The page includes the following fields:

Object	Description
<ul style="list-style-type: none"> • Mode 	Indicates the SSH mode operation. Possible modes are: <ul style="list-style-type: none"> ■ Enabled: Enable SSH mode operation. ■ Disabled: Disable SSH mode operation.

Buttons

Save: Click to save changes.

Reset: Click to undo any changes made locally and revert to previously saved values.

4.12.6 Port Security Status

This page shows the Port Security status. Port Security is a module with no direct configuration. Configuration comes indirectly from other modules - the user modules. When a user module has enabled port security on a port, the port is set-up for software-based learning. In this mode, frames from unknown MAC addresses are passed on to the port security module, which in turn asks all user modules whether to allow this new MAC address to forward or block it. For a MAC address to be set in the forwarding state, all enabled user modules must unanimously agree on allowing the MAC address to forward. If only one chooses to block it, it will be blocked until that user module decides otherwise.

The status page is divided into two sections - one with a legend of user modules and the other with the actual port status. The Port Security Status screen in [Figure 4-12-6](#) appears.

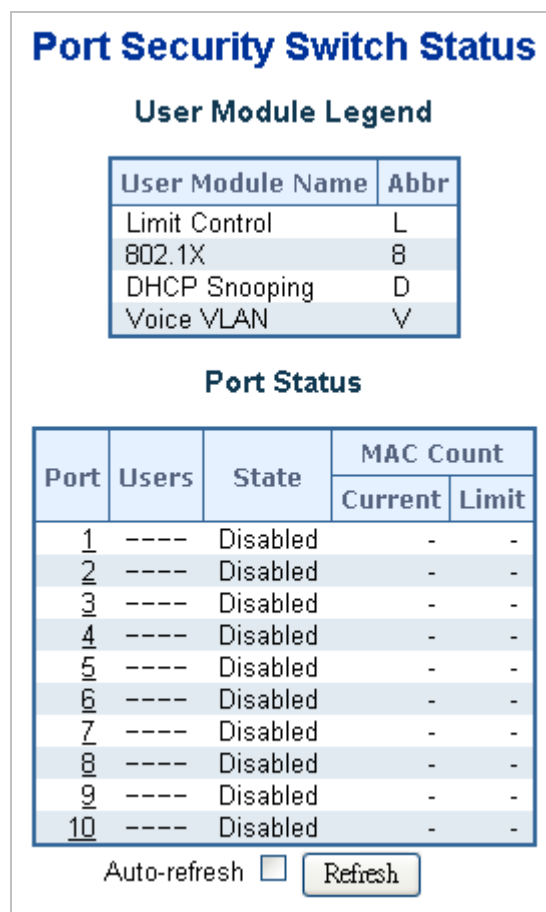

Figure 4-12-6: Port Security Status Screen Page Screenshot

The page includes the following fields:

User Module Legend

The legend shows all user modules that may request Port Security services.

Object	Description
<ul style="list-style-type: none"> • User Module Name 	The full name of a module that may request Port Security services.
<ul style="list-style-type: none"> • Abbr 	A one-letter abbreviation of the user module. This is used in the Users column in

	the port status table.
--	------------------------

Port Status

The table has one row for each port on the selected switch in the switch and a number of columns, which are:

Object	Description
<ul style="list-style-type: none"> • Port 	The port number for which the status applies. Click the port number to see the status for this particular port.
<ul style="list-style-type: none"> • Users 	Each of the user modules has a column that shows whether that module has enabled Port Security or not. A '-' means that the corresponding user module is not enabled, whereas a letter indicates that the user module abbreviated by that letter (see Abbr) has enabled port security.
<ul style="list-style-type: none"> • State 	Shows the current state of the port. It can take one of four values: <ul style="list-style-type: none"> ■ Disabled: No user modules are currently using the Port Security service. ■ Ready: The Port Security service is in use by at least one user module, and is awaiting frames from unknown MAC addresses to arrive. ■ Limit Reached: The Port Security service is enabled by at least the Limit Control user module, and that module has indicated that the limit is reached and no more MAC addresses should be taken in. ■ Shutdown: The Port Security service is enabled by at least the Limit Control user module, and that module has indicated that the limit is exceeded. No MAC addresses can be learned on the port until it is administratively re-opened on the Limit Control configuration Web-page.
<ul style="list-style-type: none"> • MAC Count (Current, Limit) 	The two columns indicate the number of currently learned MAC addresses (forwarding as well as blocked) and the maximum number of MAC addresses that can be learned on the port, respectively. If no user modules are enabled on the port, the Current column will show a dash (-). If the Limit Control user module is not enabled on the port, the Limit column will show a dash (-).

Buttons

Auto-refresh : Check this box to refresh the page automatically. Automatic refresh occurs every 3 seconds.

: Click to refresh the page immediately.

4.12.7 Port Security Detail

This page shows the MAC addresses secured by the Port Security module. Port Security is a module with no direct configuration. Configuration comes indirectly from other modules - the user modules. When a user module has enabled port security on a port, the port is set-up for software-based learning. In this mode, frames from unknown MAC addresses are passed on to the port security module, which in turn asks all user modules whether to allow this new MAC address to forward or block it. For a MAC address to be set in the forwarding state, all enabled user modules must unanimously agree on allowing the MAC address to forward. If only one chooses to block it, it will be blocked until that user module decides otherwise. The Port Security Detail screen in [Figure 4-12-7](#) appears.

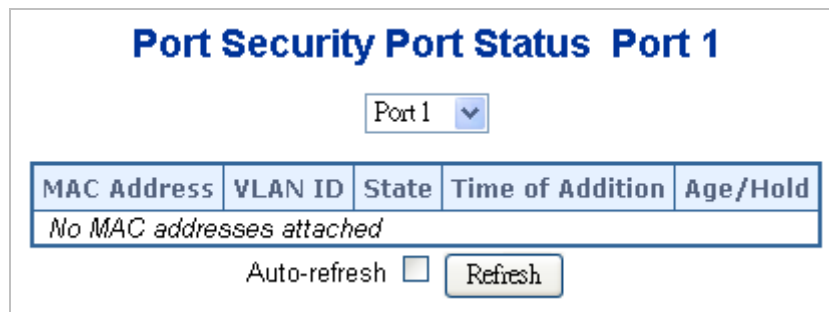

Figure 4-12-7: Port Security Detail Screen Page Screenshot

The page includes the following fields:

Object	Description
<ul style="list-style-type: none"> • MAC Address & VLAN ID 	The MAC address and VLAN ID that is seen on this port. If no MAC addresses are learned, a single row stating "No MAC addresses attached" is displayed.
<ul style="list-style-type: none"> • State 	Indicates whether the corresponding MAC address is blocked or forwarding. In the blocked state, it will not be allowed to transmit or receive traffic.
<ul style="list-style-type: none"> • Time of Addition 	Shows the date and time when this MAC address was first seen on the port.
<ul style="list-style-type: none"> • Age/Hold 	<p>If at least one user module has decided to block this MAC address, it will stay in the blocked state until the hold time (measured in seconds) expires. If all user modules have decided to allow this MAC address to forward, and aging is enabled, the Port Security module will periodically check that this MAC address still forwards traffic. If the age period (measured in seconds) expires and no frames have been seen, the MAC address will be removed from the MAC table. Otherwise a new age period will begin.</p> <p>If aging is disabled or a user module has decided to hold the MAC address indefinitely, a dash (-) will be shown.</p>

Buttons

Auto-refresh : Check this box to refresh the page automatically. Automatic refresh occurs every 3 seconds.

: Click to refresh the page immediately.

4.12.8 DHCP Snooping

DHCP Snooping is used to block intruder on the untrusted ports of DUT when it tries to intervene by injecting a bogus DHCP reply packet to a legitimate conversation between the DHCP client and server. Configure DHCP Snooping on this page. The DHCP Snooping Configuration screen in [Figure 4-12-8](#) appears.

DHCP Snooping Configuration

Snooping Mode

Port Mode Configuration

Port	Mode
*	<All>
1	Trusted
2	Trusted
3	Trusted
4	Trusted
5	Trusted
6	Trusted
7	Trusted
8	Trusted
9	Trusted
10	Trusted

Save Reset

Figure 4-12-8: DHCP Snooping Configuration Screen Page Screenshot

The page includes the following fields:

Object	Description
<ul style="list-style-type: none"> Snooping Mode 	<p>Indicates the DHCP snooping mode operation. Possible modes are:</p> <p>Enabled: Enable DHCP snooping mode operation. When enable DHCP snooping mode operation, the request DHCP messages will be forwarded to trusted ports and only allowed reply packets from trusted ports.</p> <p>Disabled: Disable DHCP snooping mode operation.</p>
<ul style="list-style-type: none"> Port Mode 	<p>Indicates the DHCP snooping port mode. Possible port modes are:</p> <p>Trusted: Configures the port as trusted sources of the DHCP message.</p> <p>Untrusted: Configures the port as untrusted sources of the DHCP message.</p> <p>All means all ports will have one specific setting</p>

Buttons

Save: Click to save changes.

Reset: Click to undo any changes made locally and revert to previously saved values.

4.12.9 DHCP Snooping Statistics

This page provides statistics for DHCP snooping. The statistics only counter packet under DHCP snooping mode is enabled and relay mode is disabled. And it doesn't count the DHCP packets for system DHCP client. The DHCP Snooping Port Statistics screen in [Figure 4-12-9](#) appears.

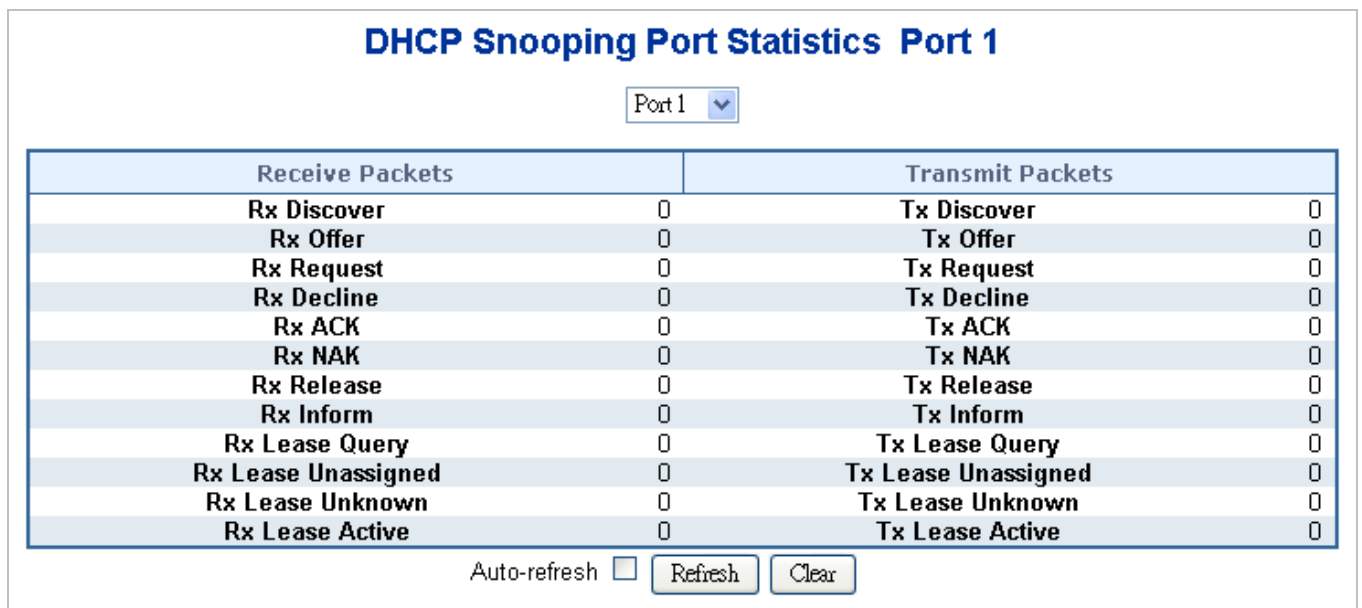

Figure 4-12-9: DHCP Snooping Port Statistics Screen Page Screenshot

The page includes the following fields:

Object	Description
• Rx and Tx Discover	The number of discover (option 53 with value 1) packets received and transmitted.
• Rx and Tx Offer	The number of offer (option 53 with value 2) packets received and transmitted.
• Rx and Tx Request	The number of request (option 53 with value 3) packets received and transmitted.
• Rx and Tx Decline	The number of decline (option 53 with value 4) packets received and transmitted.
• Rx and Tx ACK	The number of ACK (option 53 with value 5) packets received and transmitted.
• Rx and Tx NAK	The number of NAK (option 53 with value 6) packets received and transmitted.
• Rx and Tx Release	The number of release (option 53 with value 7) packets received and transmitted.

• Rx and Tx Inform	The number of inform (option 53 with value 8) packets received and transmitted.
• Rx and Tx Lease Query	The number of lease query (option 53 with value 10) packets received and transmitted.
• Rx and Tx Lease Unassigned	The number of lease unassigned (option 53 with value 11) packets received and transmitted.
• Rx and Tx Lease Unknown	The number of lease unknown (option 53 with value 12) packets received and transmitted.
• Rx and Tx Lease Active	The number of lease active (option 53 with value 13) packets received and transmitted.

Buttons

Auto-refresh : Check this box to refresh the page automatically. Automatic refresh occurs every 3 seconds.

: Click to refresh the page immediately.

: Clears the counters for the selected port.

4.12.10 IP Source Guard Configuration

IP Source Guard is a secure feature used to restrict IP traffic on DHCP snooping untrusted ports by filtering traffic based on the DHCP Snooping Table or manually configured IP Source Bindings. It helps prevent IP spoofing attacks when a host tries to spoof and use the IP address of another host. This page provides IP Source Guard related configuration. The IP Source Guard Configuration screen in [Figure 4-12-10](#) appears.

IP Source Guard Configuration

Mode

Port Mode Configuration

Port	Mode	Max Dynamic Clients
*	<All>	<All>
1	Disabled	Unlimited
2	Disabled	Unlimited
3	Disabled	Unlimited
4	Disabled	Unlimited
5	Disabled	Unlimited
6	Disabled	Unlimited
7	Disabled	Unlimited
8	Disabled	Unlimited
9	Disabled	Unlimited
10	Disabled	Unlimited

Figure 4-12-10: IP Source Guard Configuration Screen Page Screenshot

The page includes the following fields:

Object	Description
<ul style="list-style-type: none"> • Mode of IP Source Guard Configuration 	Enable the Global IP Source Guard or disable the Global IP Source Guard. All configured ACEs will be lost when the mode is enabled.
<ul style="list-style-type: none"> • Port Mode Configuration 	Specify IP Source Guard is enabled on which ports. Only when both Global Mode and Port Mode on a given port are enabled, IP Source Guard is enabled on this given port. All means all ports will have one specific setting.
<ul style="list-style-type: none"> • Max Dynamic Clients 	Specify the maximum number of dynamic clients can be learned on given ports. This value can be 0, 1, 2 and unlimited. If the port mode is enabled and the value of max dynamic client is equal 0, it means only allow the IP packets forwarding that are matched in static entries on the specific port.

	All means all ports will have one specific setting.
--	---

Buttons

: Click to translate all dynamic entries to static entries.

: Click to save changes.

: Click to undo any changes made locally and revert to previously saved values.

4.12.11 IP Source Guard Static Table

This page provides Static IP Source Guard Table. The Static IP Source Guard Table screen in [Figure 4-12-11](#) appears.

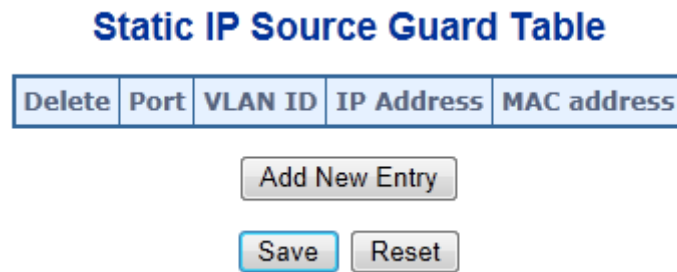

Figure 4-12-11: Static IP Source Guard Table Screen Page Screenshot

The page includes the following fields:

Object	Description
• Delete	Check to delete the entry. It will be deleted during the next save.
• Port	The logical port for the settings.
• VLAN ID	The VLAN ID for the settings.
• IP Address	Allowed Source IP address.
• MAC address	Allowed Source MAC address.

Buttons

: Click to add a new entry.

: Click to save changes.

: Click to undo any changes made locally and revert to previously saved values.

4.12.12 ARP Inspection

ARP Inspection is a secure feature. Several types of attacks can be launched against a host or devices connected to Layer 2 networks by "poisoning" the ARP caches. This feature is used to block such attacks. Only valid ARP requests and responses can go through DUT. This page provides ARP Inspection related configuration. The ARP Inspection Configuration screen in Figure 4-12-12 appears.

ARP Inspection Configuration

Mode ▼

Port Mode Configuration

Port	Mode
*	<All> ▼
1	Disabled ▼
2	Disabled ▼
3	Disabled ▼
4	Disabled ▼
5	Disabled ▼
6	Disabled ▼
7	Disabled ▼
8	Disabled ▼
9	Disabled ▼
10	Disabled ▼

Figure 4-12-12: ARP Inspection Configuration Screen Page Screenshot

The page includes the following fields:

Object	Description
<ul style="list-style-type: none"> • Mode of ARP Inspection Configuration 	Enable the Global ARP Inspection or disable the Global ARP Inspection.
<ul style="list-style-type: none"> • Port Mode Configuration 	Specify ARP Inspection is enabled on which ports. Only when both Global Mode and Port Mode on a given port are enabled, ARP Inspection is enabled on this given port. All means all ports will have one specific setting.

Buttons

Translate dynamic to static : Click to translate all dynamic entries to static entries.

Save : Click to save changes.

Reset : Click to undo any changes made locally and revert to previously saved values.

4.12.13 ARP Inspection Static Table

This page provides Static ARP Inspection Table. The Static ARP Inspection Table screen in [Figure 4-12-13](#) appears.

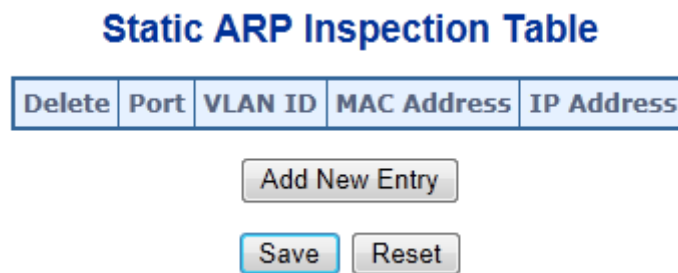

Figure 4-12-13: Static ARP Inspection Table Screen Page Screenshot

The page includes the following fields:

Object	Description
• Delete	Check to delete the entry. It will be deleted during the next save.
• Port	The logical port for the settings.
• VLAN ID	The VLAN ID for the settings.
• MAC Address	Allowed Source MAC address in ARP request packets.
• IP Address	Allowed Source IP address in ARP request packets.

Buttons

Add New Entry : Click to add a new entry.

Save : Click to save changes.

Reset : Click to undo any changes made locally and revert to previously saved values.

4.13 MAC Address Table

Switching of frames is based upon the DMAC address contained in the frame. The Managed Switch builds up a table that maps MAC addresses to switch ports for knowing which ports the frames should go to (based upon the DMAC address in the frame). This table contains both static and dynamic entries. The static entries are configured by the network administrator if the administrator wants to do a fixed mapping between the DMAC address and switch ports.

The frames also contain a MAC address (SMAC address), which shows the MAC address of the equipment sending the frame. The SMAC address is used by the switch to automatically update the MAC table with these dynamic MAC addresses. Dynamic entries are removed from the MAC table if no frame with the corresponding SMAC address have been seen after a configurable age time.

4.13.1 MAC Address Table Configuration

The MAC Address Table is configured on this page. Set timeouts for entries in the dynamic MAC Table and configure the static MAC table here. The MAC Address Table Configuration screen in [Figure 4-13-1](#) appears.

MAC Address Table Configuration

Aging Configuration

Disable Automatic Aging	<input type="checkbox"/>
Aging Time	300 seconds

MAC Table Learning

	Port Members									
	1	2	3	4	5	6	7	8	9	10
Auto	<input checked="" type="radio"/>	<input checked="" type="radio"/>	<input checked="" type="radio"/>	<input checked="" type="radio"/>	<input checked="" type="radio"/>	<input checked="" type="radio"/>	<input checked="" type="radio"/>	<input checked="" type="radio"/>	<input checked="" type="radio"/>	<input checked="" type="radio"/>
Disable	<input type="radio"/>	<input type="radio"/>	<input type="radio"/>	<input type="radio"/>	<input type="radio"/>	<input type="radio"/>	<input type="radio"/>	<input type="radio"/>	<input type="radio"/>	<input type="radio"/>
Secure	<input type="radio"/>	<input type="radio"/>	<input type="radio"/>	<input type="radio"/>	<input type="radio"/>	<input type="radio"/>	<input type="radio"/>	<input type="radio"/>	<input type="radio"/>	<input type="radio"/>

Static MAC Table Configuration

			Port Members									
Delete	VLAN ID	MAC Address	1	2	3	4	5	6	7	8	9	10
<input type="button" value="Add New Static Entry"/>												
<input type="button" value="Save"/> <input type="button" value="Reset"/>												

Figure 4-13-1: MAC Address Table Configuration Page Screenshot

The page includes the following fields:

Aging Configuration

By default, dynamic entries are removed from the MAC table after 300 seconds. This removal is also called aging.

Object	Description
<ul style="list-style-type: none"> • Disable Automatic Aging 	Enables/disables the the automatic aging of dynamic entries
<ul style="list-style-type: none"> • Aging Time 	The time after which a learned entry is discarded. By default, dynamic entries are removed from the MAC after 300 seconds. This removal is also called aging. (Range: 10-10000000 seconds; Default: 300 seconds)

MAC Table Learning

If the learning mode for a given port is greyed out, another module is in control of the mode, so that it cannot be changed by the user. An example of such a module is the MAC-Based Authentication under 802.1X.

Object	Description
<ul style="list-style-type: none"> • Auto 	Learning is done automatically as soon as a frame with unknown SMAC is received.
<ul style="list-style-type: none"> • Disable 	No learning is done.
<ul style="list-style-type: none"> • Secure 	Only static MAC entries are learned, all other frames are dropped. Note: Make sure that the link used for managing the switch is added to the Static Mac Table before changing to secure learning mode, otherwise the management link is lost and can only be restored by using another non-secure port or by connecting to the switch via the serial interface.

Static MAC Table Configuration

The static entries in the MAC table are shown in this table. The static MAC table can contain 64 entries. The MAC table is sorted first by VLAN ID and then by MAC address.

Object	Description
<ul style="list-style-type: none"> • Delete 	Check to delete the entry. It will be deleted during the next save.
<ul style="list-style-type: none"> • VLAN ID 	The VLAN ID of the entry.
<ul style="list-style-type: none"> • MAC Address 	The MAC address of the entry.
<ul style="list-style-type: none"> • Port Members 	Checkmarks indicate which ports are members of the entry. Check or uncheck as needed to modify the entry.

Buttons

Add New Static Entry : Click to add a new entry.

Save : Click to save changes.

Reset : Click to undo any changes made locally and revert to previously saved values.

4.13.2 MAC Address Table Status

Dynamic MAC Table

Entries in the MAC Table are shown on this page. The MAC Table contains up to **8192** entries, and is sorted first by VLAN ID, then by MAC address. The MAC Address Table screen in [Figure 4-13-2](#) appears.

MAC Address Table

Auto-refresh Refresh Clear << >>

Start from VLAN and MAC address with entries per page.

Type	VLAN	MAC Address	Port Members													
			CPU	1	2	3	4	5	6	7	8	9	10			
Static	1	00-30-4F-10-02-00	✓													
Static	1	33-33-FF-10-02-00	✓													
Static	1	33-33-FF-A8-00-64	✓													
Dynamic	1	40-61-86-04-18-69		✓												
Static	1	FF-FF-FF-FF-FF-FF	✓	✓	✓	✓	✓	✓	✓	✓	✓	✓	✓	✓	✓	✓

Figure 4-13-2: MAC Address Table Status Page Screenshot

Navigating the MAC Table

Each page shows up to 999 entries from the MAC table, default being 20, selected through the **"entries per page"** input field. When first visited, the web page will show the first 20 entries from the beginning of the MAC Table. The first displayed will be the one with the lowest VLAN ID and the lowest MAC address found in the MAC Table.

The **"Start from MAC address"** and **"VLAN"** input fields allow the user to select the starting point in the MAC Table. Clicking the **"Refresh"** button will update the displayed table starting from that or the closest next MAC Table match.

In addition, the two input fields will - upon a **"Refresh"** button click - assume the value of the first displayed entry, allowing for continuous refresh with the same start address.

The **">>"** will use the last entry of the currently displayed VLAN/MAC address pairs as a basis for the next lookup. When the end is reached the text "no more entries" is shown in the displayed table. Use the **"<<"** button to start over.

The page includes the following fields:

Object	Description
• Type	Indicates whether the entry is a static or dynamic entry.
• VLAN	The VLAN ID of the entry.
• MAC Address	The MAC address of the entry.
• Port Members	The ports that are members of the entry.

Buttons

Auto-refresh : Check this box to refresh the page automatically. Automatic refresh occurs every 3 seconds.

: Refreshes the displayed table starting from the "Start from MAC address" and "VLAN" input fields.

: Flushes all dynamic entries.

: Updates the table starting from the first entry in the MAC Table, i.e. the entry with the lowest VLAN ID and MAC address.

: Updates the table, starting with the entry after the last entry currently displayed.

4.13.3 Dynamic ARP Inspection Table

Entries in the Dynamic ARP Inspection Table are shown on this page. The Dynamic ARP Inspection Table contains up to 1024 entries, and is sorted first by port, then by VLAN ID, then by MAC address, and then by IP address. The Dynamic ARP Inspection Table screen in [Figure 4-13-3](#) appears.

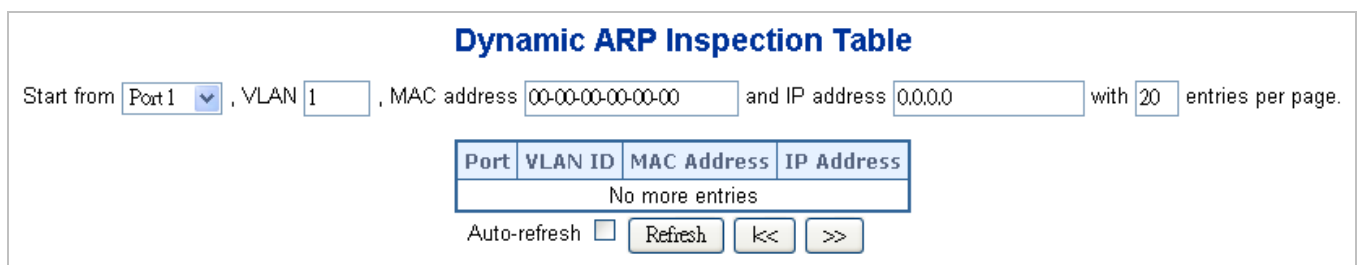

Figure 4-13-3: Dynamic ARP Inspection Table Screenshot

Navigating the ARP Inspection Table

Each page shows up to 999 entries from the Dynamic ARP Inspection table, default being 20, selected through the "entries per page" input field. When first visited, the web page will show the first 20 entries from the beginning of the Dynamic ARP Inspection Table.

The "Start from port address", "VLAN", "MAC address" and "IP address" input fields allow the user to select the starting point in the Dynamic ARP Inspection Table. Clicking the "Refresh" button will update the displayed table starting from that or the closest next Dynamic ARP Inspection Table match. In addition, the two input fields will - upon a "Refresh" button click - assume

the value of the first displayed entry, allowing for continuous refresh with the same start address.

The ">>" will use the last entry of the currently displayed as a basis for the next lookup. When the end is reached the text "No more entries" is shown in the displayed table. Use the "<<" button to start over.

The page includes the following fields:

Object	Description
• Port	Switch Port Number for which the entries are displayed.
• VLAN ID	VLAN-ID in which the ARP traffic is permitted.
• MAC Address	User MAC address of the entry.
• IP Address	User IP address of the entry.

Buttons

Auto-refresh : Check this box to refresh the page automatically. Automatic refresh occurs every 3 seconds.

: Refreshes the displayed table starting from the input fields.

: Updates the table starting from the first entry in the Dynamic ARP Inspection Table.

: Updates the table, starting with the entry after the last entry currently displayed.

4.13.4 Dynamic IP Source Guard Table

Entries in the Dynamic IP Source Guard Table are shown on this page. The Dynamic IP Source Guard Table is sorted first by port, then by VLAN ID, then by IP address, and then by MAC address. The Dynamic IP Source Guard Table screen in [Figure 4-13-4](#) appears.

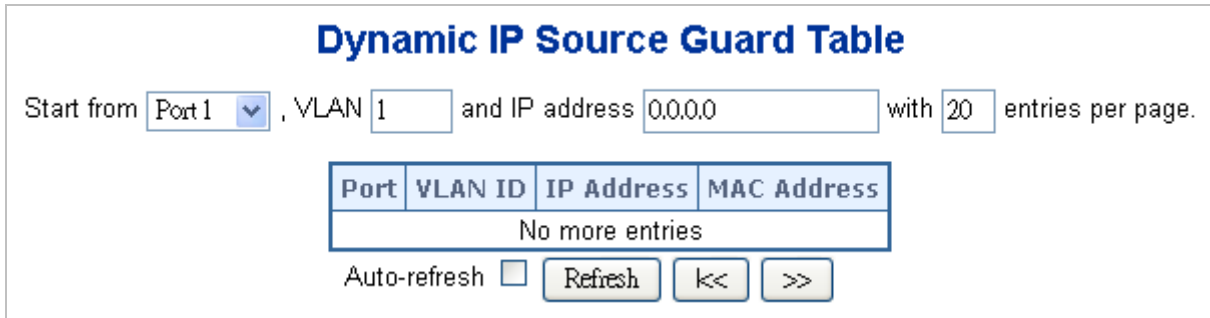

Figure 4-13-4: Dynamic IP Source Guard Table Screenshot

Navigating the ARP Inspection Table

Each page shows up to 99 entries from the Dynamic IP Source Guard table, default being 20, selected through the "**entries per page**" input field. When first visited, the web page will show the first 20 entries from the beginning of the Dynamic IP Source Guard Table. The "**Start from port address**", "**VLAN**", "**IP address**" and "**IP mask**" input fields allow the user to select the starting point in the Dynamic IP Source Guard Table. Clicking the "**Refresh**" button will update the displayed table starting from that or the closest next Dynamic IP Source Guard Table match. In addition, the two input fields will - upon a "**Refresh**" button click - assume the value of the first displayed entry, allowing for continuous refresh with the same start address.

The ">>" will use the last entry of the currently displayed as a basis for the next lookup. When the end is reached the text "No more entries" is shown in the displayed table. Use the "<<" button to start over.

The page includes the following fields:

Object	Description
• Port	Switch Port Number for which the entries are displayed.
• VLAN ID	VLAN-ID in which the IP traffic is permitted.
• IP Address	User IP Address of the entry.
• MAC Address	Source MAC Address.

Buttons

Auto-refresh : Check this box to refresh the page automatically. Automatic refresh occurs every 3 seconds.

: Refreshes the displayed table starting from the "Start from MAC address" and "VLAN" input fields.

: Updates the table starting from the first entry in the Dynamic IP Source Guard Table.

: Updates the table, starting with the entry after the last entry currently displayed.

4.14 LLDP

4.14.1 Link Layer Discovery Protocol

Link Layer Discovery Protocol (LLDP) is used to discover basic information about neighboring devices on the local broadcast domain. LLDP is a Layer 2 protocol that uses periodic broadcasts to advertise information about the sending device. Advertised information is represented in **Type Length Value (TLV)** format according to the IEEE 802.1ab standard, and can include details such as device identification, capabilities and configuration settings. LLDP also defines how to store and maintain information gathered about the neighboring network nodes it discovers.

Link Layer Discovery Protocol - Media Endpoint Discovery (LLDP-MED) is an extension of LLDP intended for managing endpoint devices such as Voice over IP phones and network switches. The LLDP-MED TLVs advertise information such as network policy, power, inventory, and device location details. LLDP and LLDP-MED information can be used by SNMP applications to simplify troubleshooting, enhance network management, and maintain an accurate network topology.

4.14.2 LLDP Configuration

This page allows the user to inspect and configure the current LLDP port settings. The LLDP Configuration screen in [Figure 4-14-1](#) appears.

LLDP Configuration

LLDP Parameters

Tx Interval	30	seconds
Tx Hold	4	times
Tx Delay	2	seconds
Tx Reinit	2	seconds

LLDP Port Configuration

Port	Mode	CDP Aware	Optional TLVs				
			Port Description	System Name	System Description	System Capabilities	Management Address
*	<All>	<input type="checkbox"/>	<input type="checkbox"/>	<input type="checkbox"/>	<input type="checkbox"/>	<input type="checkbox"/>	<input type="checkbox"/>
1	Disabled	<input type="checkbox"/>	<input checked="" type="checkbox"/>	<input checked="" type="checkbox"/>	<input checked="" type="checkbox"/>	<input checked="" type="checkbox"/>	<input checked="" type="checkbox"/>
2	Disabled	<input type="checkbox"/>	<input checked="" type="checkbox"/>	<input checked="" type="checkbox"/>	<input checked="" type="checkbox"/>	<input checked="" type="checkbox"/>	<input checked="" type="checkbox"/>
3	Disabled	<input type="checkbox"/>	<input checked="" type="checkbox"/>	<input checked="" type="checkbox"/>	<input checked="" type="checkbox"/>	<input checked="" type="checkbox"/>	<input checked="" type="checkbox"/>
4	Disabled	<input type="checkbox"/>	<input checked="" type="checkbox"/>	<input checked="" type="checkbox"/>	<input checked="" type="checkbox"/>	<input checked="" type="checkbox"/>	<input checked="" type="checkbox"/>
5	Disabled	<input type="checkbox"/>	<input checked="" type="checkbox"/>	<input checked="" type="checkbox"/>	<input checked="" type="checkbox"/>	<input checked="" type="checkbox"/>	<input checked="" type="checkbox"/>
6	Disabled	<input type="checkbox"/>	<input checked="" type="checkbox"/>	<input checked="" type="checkbox"/>	<input checked="" type="checkbox"/>	<input checked="" type="checkbox"/>	<input checked="" type="checkbox"/>
7	Disabled	<input type="checkbox"/>	<input checked="" type="checkbox"/>	<input checked="" type="checkbox"/>	<input checked="" type="checkbox"/>	<input checked="" type="checkbox"/>	<input checked="" type="checkbox"/>
8	Disabled	<input type="checkbox"/>	<input checked="" type="checkbox"/>	<input checked="" type="checkbox"/>	<input checked="" type="checkbox"/>	<input checked="" type="checkbox"/>	<input checked="" type="checkbox"/>
9	Disabled	<input type="checkbox"/>	<input checked="" type="checkbox"/>	<input checked="" type="checkbox"/>	<input checked="" type="checkbox"/>	<input checked="" type="checkbox"/>	<input checked="" type="checkbox"/>
10	Disabled	<input type="checkbox"/>	<input checked="" type="checkbox"/>	<input checked="" type="checkbox"/>	<input checked="" type="checkbox"/>	<input checked="" type="checkbox"/>	<input checked="" type="checkbox"/>

Figure 4-14-1: LLDP Configuration Page Screenshot

The page includes the following fields:

LLDP Parameters

Object	Description
<ul style="list-style-type: none"> Tx Interval 	<p>The switch is periodically transmitting LLDP frames to its neighbors for having the network discovery information up-to-date. The interval between each LLDP frame is determined by the Tx Interval value. Valid values are restricted to 5 - 32768 seconds.</p> <p>Default: 30 seconds</p> <p>This attribute must comply with the following rule:</p> <p>$(\text{Transmission Interval} * \text{Hold Time Multiplier}) \leq 65536$, and $\text{Transmission Interval} \geq (4 * \text{Delay Interval})$</p>
<ul style="list-style-type: none"> Tx Hold 	<p>Each LLDP frame contains information about how long the information in the LLDP frame shall be considered valid. The LLDP information valid period is set to Tx Hold multiplied by Tx Interval seconds. Valid values are restricted to 2 - 10 times.</p> <p>TTL in seconds is based on the following rule:</p> <p>$(\text{Transmission Interval} * \text{Holdtime Multiplier}) \leq 65536$.</p> <p>Therefore, the default TTL is $4 * 30 = 120$ seconds.</p>
<ul style="list-style-type: none"> Tx Delay 	<p>If some configuration is changed (e.g. the IP address) a new LLDP frame is transmitted, but the time between the LLDP frames will always be at least the value of Tx Delay seconds. Tx Delay cannot be larger than 1/4 of the Tx Interval value. Valid values are restricted to 1 - 8192 seconds.</p> <p>This attribute must comply with the rule:</p> <p>$(4 * \text{Delay Interval}) \leq \text{Transmission Interval}$</p>
<ul style="list-style-type: none"> Tx Reinit 	<p>When a port is disabled, LLDP is disabled or the switch is rebooted a LLDP shutdown frame is transmitted to the neighboring units, signaling that the LLDP information isn't valid anymore. Tx Reinit controls the amount of seconds between the shutdown frame and a new LLDP initialization. Valid values are restricted to 1 - 10 seconds.</p>

LLDP Port Configuration

The LLDP port settings relate to the currently selected stack unit, as reflected by the page header.

Object	Description
<ul style="list-style-type: none"> Port 	The switch port number of the logical LLDP port.
<ul style="list-style-type: none"> Mode 	Select LLDP mode. All means all ports will have one specific setting.

	<ul style="list-style-type: none"> ■ Rx only The switch will not send out LLDP information, but LLDP information from neighbor units is analyzed. ■ Tx only The switch will drop LLDP information received from neighbors, but will send out LLDP information. ■ Disabled The switch will not send out LLDP information, and will drop LLDP information received from neighbors. ■ Enabled The switch will send out LLDP information, and will analyze LLDP information received from neighbors.
<ul style="list-style-type: none"> • CDP Aware 	<p>Select CDP awareness.</p> <p>The CDP operation is restricted to decoding incoming CDP frames (The switch doesn't transmit CDP frames). CDP frames are only decoded if LLDP on the port is enabled.</p> <p>Only CDP TLVs that can be mapped to a corresponding field in the LLDP neighbours' table are decoded. All other TLVs are discarded (Unrecognized CDP TLVs and discarded CDP frames are not shown in the LLDP statistics.). CDP TLVs are mapped onto LLDP neighbours' table as shown below.</p> <ul style="list-style-type: none"> ■ CDP TLV "Device ID" is mapped to the LLDP "Chassis ID" field. ■ CDP TLV "Address" is mapped to the LLDP "Management Address" field. The CDP address TLV can contain multiple addresses, but only the first address is shown in the LLDP neighbours table. ■ CDP TLV "Port ID" is mapped to the LLDP "Port ID" field. ■ CDP TLV "Version and Platform" is mapped to the LLDP "System Description" field. <p>Both the CDP and LLDP support "system capabilities", but the CDP capabilities cover capabilities that are not part of the LLDP. These capabilities are shown as "others" in the LLDP neighbours' table.</p> <p>If all ports have CDP awareness disabled the switch forwards CDP frames received from neighbour devices. If at least one port has CDP awareness enabled all CDP frames are terminated by the switch.</p> <p>Note: When CDP awareness on a port is disabled the CDP information isn't removed immediately, but gets removed when the hold time is exceeded.</p>
<ul style="list-style-type: none"> • Port Description 	<p>Optional TLV: When checked the "port description" is included in LLDP information transmitted.</p>
<ul style="list-style-type: none"> • System Name 	<p>Optional TLV: When checked the "system name" is included in LLDP information transmitted.</p>
<ul style="list-style-type: none"> • System Description 	<p>Optional TLV: When checked the "system description" is included in LLDP information transmitted.</p>
<ul style="list-style-type: none"> • System Capabilities 	<p>Optional TLV: When checked the "system capability" is included in LLDP information transmitted.</p>

	<p>The system capabilities identifies the primary function(s) of the system and whether or not these primary functions are enabled. The information advertised by this TLV is described in IEEE 802.1AB.</p>
<ul style="list-style-type: none">• Management Address	<p>Optional TLV: When checked the "management address" is included in LLDP information transmitted.</p> <p>The management address protocol packet includes the IPv4 address of the switch. If no management address is available, the address should be the MAC address for the CPU or for the port sending this advertisement. The management address TLV may also include information about the specific interface associated with this address, and an object identifier indicating the type of hardware component or protocol entity associated with this address</p>

Buttons



: Click to save changes.



: Click to undo any changes made locally and revert to previously saved values.

4.14.3 LLDP-MED Configuration

This page allows you to configure the LLDP-MED. The LLDP-MED Configuration screen in [Figure 4-14-2](#) appears.

LLDP-MED Configuration

Fast Start Repeat Count

Fast start repeat count

Coordinates Location

Latitude ° North ° East Altitude Meters Map Datum WGS84

Civic Address Location

Country code		State	
City		City district	
Street		Leading street direction	
Street suffix		House no.	
Landmark		Additional location info	
Zip code		Building	
Floor		Room no.	
Postal community name		P.O. Box	

Emergency Call Service

Emergency Call Service

Policies

Delete	Policy ID	Application Type	Tag	VLAN ID	L2 Priority	DSCP
No entries present						

Figure 4-14-2: LLDP-MED Configuration Page Screenshot

The page includes the following fields:

Fast Start Repeat Count

Object	Description
<ul style="list-style-type: none"> Fast start repeat count 	<p>Rapid startup and Emergency Call Service Location Identification Discovery of endpoints is a critically important aspect of VoIP systems in general. In addition, it is best to advertise only those pieces of information which are specifically relevant to particular endpoint types (for example only advertise the voice network policy to permitted voice-capable devices), both in order to conserve the limited LLDPDU space and to reduce security and system integrity issues that can come with inappropriate knowledge of the network policy.</p> <p>With this in mind LLDP-MED defines an LLDP-MED Fast Start interaction between the protocol and the application layers on top of the protocol, in order to achieve these related properties. Initially, a Network Connectivity Device will only transmit LLDP TLVs in an LLDPDU. Only after an LLDP-MED Endpoint Device is detected, will an LLDP-MED capable Network Connectivity Device start to advertise LLDP-MED TLVs in outgoing LLDPDUs on the associated port. The LLDP-MED application will temporarily speed up the transmission of the</p>

	<p>LLDPDU to start within a second, when a new LLDP-MED neighbor has been detected in order share LLDP-MED information as fast as possible to new neighbors.</p> <p>Because there is a risk that a LLDP frame being lost during transmission between neighbors, it is recommended to repeat the fast start transmission multiple times to increase the possibility for that the neighbors has received the LLDP frame. With Fast start repeat count it is possible to specify the number of times the fast start transmission is repeated. The recommended value is 4 times, giving that 4 LLDP frames with a 1 second interval will be transmitted, when a LLDP frame with new information is received.</p> <p>It should be noted that LLDP-MED and the LLDP-MED Fast Start mechanism is only intended to run on links between LLDP-MED Network Connectivity Devices and Endpoint Devices, and as such does not apply to links between LAN infrastructure elements, including between Network Connectivity Devices, or to other types of links.</p>
--	--

Coordinates Location

Object	Description
<ul style="list-style-type: none"> • Latitude 	<p>Latitude SHOULD be normalized to within 0-90 degrees with a maximum of 4 digits.</p> <p>It is possible to specify the direction to either North of the equator or South of the equator.</p>
<ul style="list-style-type: none"> • Longitude 	<p>Longitude SHOULD be normalized to within 0-180 degrees with a maximum of 4 digits.</p> <p>It is possible to specify the direction to either East of the prime meridian or West of the prime meridian.</p>
<ul style="list-style-type: none"> • Altitude 	<p>Altitude SHOULD be normalized to within -32767 to 32767 with a maximum of 4 digits.</p> <p>It is possible to select between two altitude types (floors or meters).</p> <p>Meters: Representing meters of Altitude defined by the vertical datum specified.</p> <p>Floors: Representing altitude in a form more relevant in buildings which have different floor-to-floor dimensions. An altitude = 0.0 is meaningful even outside a building, and represents ground level at the given latitude and longitude. Inside a building, 0.0 represents the floor level associated with ground level at the main entrance.</p>
<ul style="list-style-type: none"> • Map Datum 	<p>The Map Datum used for the coordinates given in this Option</p> <p>WGS84: (Geographical 3D) - World Geodesic System 1984, CRS Code 4327, Prime Meridian Name: Greenwich.</p> <p>NAD83/NAVD88: North American Datum 1983, CRS Code 4269, Prime Meridian</p>

	<p>Name: Greenwich; The associated vertical datum is the North American Vertical Datum of 1988 (NAVD88). This datum pair is to be used when referencing locations on land, not near tidal water (which would use Datum = NAD83/MLLW).</p> <p>NAVD88/MLLW: North American Datum 1983, CRS Code 4269, Prime Meridian</p> <p>Name: Greenwich; The associated vertical datum is Mean Lower Low Water (MLLW). This datum pair is to be used when referencing locations on water/sea/ocean.</p>
--	--

Civic Address Location

IETF Geopriv Civic Address based Location Configuration Information (Civic Address LCI).

Object	Description
• Country code	The two-letter ISO 3166 country code in capital ASCII letters - Example: DK, DE or US.
• State	National subdivisions (state, canton, region, province, prefecture).
• County	County, parish, gun (Japan), district.
• City	City, township, shi (Japan) - Example: Copenhagen
• City district	City division, borough, city district, ward, chou (Japan)
• Block (Neighborhood)	Neighborhood, block
• Street	Street - Example: Poppelvej
• Leading street direction	Leading street direction - Example: N
• Trailing street suffix	Trailing street suffix - Example: SW
• Street suffix	Street suffix - Example: Ave, Platz
• House no.	House number - Example: 21
• House no. suffix	House number suffix - Example: A, 1/2
• Landmark	Landmark or vanity address - Example: Columbia University
• Additional location info	Additional location info - Example: South Wing
• Name	Name (residence and office occupant) - Example: Flemming Jahn
• Zip code	Postal/zip code - Example: 2791
• Building	Building (structure) - Example: Low Library
• Apartment	Unit (Apartment, suite) - Example: Apt 42
• Floor	Floor - Example: 4

• Room no.	Room number - Example: 450F
• Place type	Place type - Example: Office
• Postal community name	Postal community name - Example: Leonia
• P.O. Box	Post office box (P.O. BOX) - Example: 12345
• Additional code	Additional code - Example: 1320300003

Emergency Call Service

Emergency Call Service (e.g. E911 and others), such as defined by TIA or NENA.

Object	Description
• Emergency Call Service	Emergency Call Service ELIN identifier data format is defined to carry the ELIN identifier as used during emergency call setup to a traditional CAMA or ISDN trunk-based PSAP. This format consists of a numerical digit string, corresponding to the ELIN to be used for emergency calling.

Policies

Network Policy Discovery enables the efficient discovery and diagnosis of mismatch issues with the VLAN configuration, along with the associated Layer 2 and Layer 3 attributes, which apply for a set of specific protocol applications on that port. Improper network policy configurations are a very significant issue in VoIP environments that frequently result in voice quality degradation or loss of service.

Policies are only intended for use with applications that have specific 'real-time' network policy requirements, such as interactive voice and/or video services.

The network policy attributes advertised are:

1. Layer 2 VLAN ID (IEEE 802.1Q-2003)
2. Layer 2 priority value (IEEE 802.1D-2004)
3. Layer 3 Diffserv code point (DSCP) value (IETF RFC 2474)

This network policy is potentially advertised and associated with multiple sets of application types supported on a given port.

The application types specifically addressed are:

1. Voice
2. Guest Voice
3. Softphone Voice
4. Video Conferencing
5. Streaming Video
6. Control / Signaling (conditionally support a separate network policy for the media types above)

A large network may support multiple VoIP policies across the entire organization, and different policies per application type.

LLDP-MED allows multiple policies to be advertised per port, each corresponding to a different application type. Different ports on the same Network Connectivity Device may advertise different sets of policies, based on the authenticated user identity or

port configuration.

It should be noted that LLDP-MED is not intended to run on links other than between Network Connectivity Devices and Endpoints, and therefore does not need to advertise the multitude of network policies that frequently run on an aggregated link interior to the LAN.

Object	Description
<ul style="list-style-type: none"> • Delete 	Check to delete the policy. It will be deleted during the next save.
<ul style="list-style-type: none"> • Policy ID 	ID for the policy. This is auto generated and shall be used when selecting the polices that shall be mapped to the specific ports.
<ul style="list-style-type: none"> • Application Type 	<p>Intended use of the application types:</p> <p>Voice - for use by dedicated IP Telephony handsets and other similar appliances supporting interactive voice services. These devices are typically deployed on a separate VLAN for ease of deployment and enhanced security by isolation from data applications.</p> <p>Voice Signaling (conditional) - for use in network topologies that require a different policy for the voice signaling than for the voice media. This application type should not be advertised if all the same network policies apply as those advertised in the Voice application policy.</p> <p>Guest Voice - support a separate 'limited feature-set' voice service for guest users and visitors with their own IP Telephony handsets and other similar appliances supporting interactive voice services.</p> <p>Guest Voice Signaling (conditional) - for use in network topologies that require a different policy for the guest voice signaling than for the guest voice media. This application type should not be advertised if all the same network policies apply as those advertised in the Guest Voice application policy.</p> <p>Softphone Voice - for use by softphone applications on typical data centric devices, such as PCs or laptops. This class of endpoints frequently does not support multiple VLANs, if at all, and are typically configured to use an 'untagged' VLAN or a single 'tagged' data specific VLAN. When a network policy is defined for use with an 'untagged' VLAN (see Tagged flag below), then the L2 priority field is ignored and only the DSCP value has relevance.</p> <p>Video Conferencing</p> <p>Streaming Video - for use by broadcast or multicast based video content distribution and other similar applications supporting streaming video services that require specific network policy treatment. Video applications relying on TCP with buffering would not be an intended use of this application type.</p> <p>Video Signaling (conditional) - for use in network topologies that require a separate policy for the video signaling than for the video media. This application type should not be advertised if all the same network policies apply as those</p>

	advertised in the Video Conferencing application policy.
<ul style="list-style-type: none"> • Tag 	<p>Tag indicating whether the specified application type is using a 'tagged' or an 'untagged' VLAN.</p> <p>Untagged indicates that the device is using an untagged frame format and as such does not include a tag header as defined by IEEE 802.1Q-2003. In this case, both the VLAN ID and the Layer 2 priority fields are ignored and only the DSCP value has relevance.</p> <p>Tagged indicates that the device is using the IEEE 802.1Q tagged frame format, and that both the VLAN ID and the Layer 2 priority values are being used, as well as the DSCP value. The tagged format includes an additional field, known as the tag header. The tagged frame format also includes priority tagged frames as defined by IEEE 802.1Q-2003.</p>
<ul style="list-style-type: none"> • VLAN ID 	VLAN identifier (VID) for the port as defined in IEEE 802.1Q-2003
<ul style="list-style-type: none"> • L2 Priority 	L2 Priority is the Layer 2 priority to be used for the specified application type. L2 Priority may specify one of eight priority levels (0 through 7), as defined by IEEE 802.1D-2004. A value of 0 represents use of the default priority as defined in IEEE 802.1D-2004.
<ul style="list-style-type: none"> • DSCP 	DSCP value to be used to provide Diffserv node behavior for the specified application type as defined in IETF RFC 2474. DSCP may contain one of 64 code point values (0 through 63). A value of 0 represents use of the default DSCP value as defined in RFC 2475.

Port Policies Configuration

Every port may advertise a unique set of network policies or different attributes for the same network policies, based on the authenticated user identity or port configuration.

Object	Description
<ul style="list-style-type: none"> • Port 	The port number for which the configuration applies.
<ul style="list-style-type: none"> • Policy ID 	The set of policies that shall apply for a given port. The set of policies is selected by checkmarking the checkboxes that corresponds to the policies

Buttons

: click to add new policy.

: Click to save changes.

: Click to undo any changes made locally and revert to previously saved values.

4.14.4 LLDP-MED Neighbor

This page provides a status overview for all LLDP-MED neighbors. The displayed table contains a row for each port on which an LLDP neighbor is detected. The LLDP-MED Neighbor Information screen in [Figure 4-14-3](#) appears. The columns hold the following information:

LLDP-MED Neighbour Information

Local Port

No LLDP-MED neighbour information found

Auto-refresh

LLDP-MED Neighbour Information

Port 2					
Device Type	Capabilities				
Endpoint Class III	LLDP-MED Capabilities, Network Policy, Extended Power via MDI - PD, Inventory				
Application Type	Policy	Tag	VLAN ID	Priority	DSCP
Voice=Defined=Untagged=s-s=46 Voice Signaling=Defined=Untagged=s-s=32					
Auto-negotiation	Auto-negotiation status	Auto-negotiation Capabilities		MAU Type	
Supported	Enabled	1000BASE-T half duplex mode, 1000BASE-X, -LX, -SX, -CX full duplex mode, Asymmetric and Symmetric PAUSE for full-duplex inks, Symmetric PAUSE for full-duplex links		100BaseTXFD - 2 pair category 5 UTP, full duplex mode	

Auto-refresh

Figure 4-14-3: LLDP-MED Neighbor Information Page Screenshot

The page includes the following fields:

Fast Start Repeat Count

Object	Description
<ul style="list-style-type: none"> Port 	The port on which the LLDP frame was received.
<ul style="list-style-type: none"> Device Type 	<p>LLDP-MED Devices are comprised of two primary Device Types: Network Connectivity Devices and Endpoint Devices.</p> <p>LLDP-MED Network Connectivity Device Definition</p> <p>LLDP-MED Network Connectivity Devices, as defined in TIA-1057, provide access to the IEEE 802 based LAN infrastructure for LLDP-MED Endpoint Devices. An LLDP-MED Network Connectivity Device is a LAN access device based on any of the following technologies:</p> <ol style="list-style-type: none"> 1. LAN Switch/Router 2. IEEE 802.1 Bridge 3. IEEE 802.3 Repeater (included for historical reasons) 4. IEEE 802.11 Wireless Access Point 5. Any device that supports the IEEE 802.1AB and MED extensions defined by TIA-1057 and can relay IEEE 802 frames via any method. <p>LLDP-MED Endpoint Device Definition</p>

Within the LLDP-MED Endpoint Device category, the LLDP-MED scheme is broken into further Endpoint Device Classes, as defined in the following. Each LLDP-MED Endpoint Device Class is defined to build upon the capabilities defined for the previous Endpoint Device Class. For example, will any LLDP-MED Endpoint Device claiming compliance as a Media Endpoint (Class II) also support all aspects of TIA-1057 applicable to Generic Endpoints (Class I), and any LLDP-MED Endpoint Device claiming compliance as a Communication Device (Class III) will also support all aspects of TIA-1057 applicable to both Media Endpoints (Class II) and Generic Endpoints (Class I).

LLDP-MED Generic Endpoint (Class I)

The LLDP-MED Generic Endpoint (Class I) definition is applicable to all endpoint products that require the base LLDP discovery services defined in TIA-1057, however do not support IP media or act as an end-user communication appliance. Such devices may include (but are not limited to) IP Communication Controllers, other communication related servers, or any device requiring basic services as defined in TIA-1057.

Discovery services defined in this class include LAN configuration, device location, network policy, power management, and inventory management.

LLDP-MED Media Endpoint (Class II)

The LLDP-MED Media Endpoint (Class II) definition is applicable to all endpoint products that have IP media capabilities however may or may not be associated with a particular end user. Capabilities include all of the capabilities defined for the previous Generic Endpoint Class (Class I), and are extended to include aspects related to media streaming. Example product categories expected to adhere to this class include (but are not limited to) Voice / Media Gateways, Conference Bridges, Media Servers, and similar.

Discovery services defined in this class include media-type-specific network layer policy discovery.

LLDP-MED Communication Endpoint (Class III)

The LLDP-MED Communication Endpoint (Class III) definition is applicable to all endpoint products that act as end user communication appliances supporting IP media. Capabilities include all of the capabilities defined for the previous Generic Endpoint (Class I) and Media Endpoint (Class II) classes, and are extended to include aspects related to end user devices. Example product categories expected to adhere to this class include (but are not limited to) end user communication appliances, such as IP Phones, PC-based softphones, or other communication appliances that directly support the end user.

Discovery services defined in this class include provision of location identifier (including ECS / E911 information), embedded L2 switch support, inventory management

<ul style="list-style-type: none"> • LLDP-MED Capabilities 	<p>LLDP-MED Capabilities describes the neighbor unit's LLDP-MED capabilities.</p> <p>The possible capabilities are:</p> <ol style="list-style-type: none"> 1. LLDP-MED capabilities 2. Network Policy 3. Location Identification 4. Extended Power via MDI - PSE 5. Extended Power via MDI - PD 6. Inventory 7. Reserved
<ul style="list-style-type: none"> • Application Type 	<p>Application Type indicating the primary function of the application(s) defined for this network policy, advertised by an Endpoint or Network Connectivity Device.</p> <p>The possible application types are shown below.</p> <ul style="list-style-type: none"> ■ Voice - for use by dedicated IP Telephony handsets and other similar appliances supporting interactive voice services. These devices are typically deployed on a separate VLAN for ease of deployment and enhanced security by isolation from data applications. ■ Voice Signaling - for use in network topologies that require a different policy for the voice signaling than for the voice media. ■ Guest Voice - to support a separate limited feature-set voice service for guest users and visitors with their own IP Telephony handsets and other similar appliances supporting interactive voice services. ■ Guest Voice Signaling - for use in network topologies that require a different policy for the guest voice signaling than for the guest voice media. ■ Softphone Voice - for use by softphone applications on typical data centric devices, such as PCs or laptops. ■ Video Conferencing - for use by dedicated Video Conferencing equipment and other similar appliances supporting real-time interactive video/audio services. ■ Streaming Video - for use by broadcast or multicast based video content distribution and other similar applications supporting streaming video services that require specific network policy treatment. Video applications relying on TCP with buffering would not be an intended use of this application type. ■ Video Signaling - for use in network topologies that require a separate policy for the video signaling than for the video media.
<ul style="list-style-type: none"> • Policy 	<p>Policy</p> <p>Unknown: The network policy for the specified application type is currently unknown.</p> <p>Defined: The network policy is defined.</p>

<ul style="list-style-type: none"> • TAG 	<p>TAG is indicating whether the specified application type is using a tagged or an untagged VLAN. Can be Tagged or Untagged</p> <ul style="list-style-type: none"> ■ Untagged: The device is using an untagged frame format and as such does not include a tag header as defined by IEEE 802.1Q-2003. ■ Tagged: The device is using the IEEE 802.1Q tagged frame format
<ul style="list-style-type: none"> • VLAN ID 	<p>VLAN ID is the VLAN identifier (VID) for the port as defined in IEEE 802.1Q-2003. A value of 1 through 4094 is used to define a valid VLAN ID. A value of 0 (Priority Tagged) is used if the device is using priority tagged frames as defined by IEEE 802.1Q-2003, meaning that only the IEEE 802.1D priority level is significant and the default PVID of the ingress port is used instead.</p>
<ul style="list-style-type: none"> • Priority 	<p>Priority is the Layer 2 priority to be used for the specified application type. One of eight priority levels (0 through 7)</p>
<ul style="list-style-type: none"> • DSCP 	<p>DSCP is the DSCP value to be used to provide Diffserv node behavior for the specified application type as defined in IETF RFC 2474. Contain one of 64 code point values (0 through 63).</p>
<ul style="list-style-type: none"> • Auto-negotiation 	<p>Auto-negotiation identifies if MAC/PHY auto-negotiation is supported by the link partner.</p>
<ul style="list-style-type: none"> • Auto-negotiation status 	<p>Auto-negotiation status identifies if auto-negotiation is currently enabled at the link partner. If Auto-negotiation is supported and Auto-negotiation status is disabled, the 802.3 PMD operating mode will be determined the operational MAU type field value rather than by auto-negotiation.</p>
<ul style="list-style-type: none"> • Auto-negotiation Capabilities 	<p>Auto-negotiation Capabilities shows the link partners MAC/PHY capabilities.</p>

Buttons

Auto-refresh : Check this box to refresh the page automatically. Automatic refresh occurs every 3 seconds.

: Click to refresh the page immediately.

4.14.5 Neighbor

This page provides a status overview for all LLDP neighbors. The displayed table contains a row for each port on which an LLDP neighbor is detected. The LLDP Neighbor Information screen in [Figure 4-14-4](#) appears.



Figure 4-14-4: LLDP Neighbor Information Page Screenshot

The page includes the following fields:

Object	Description
• Local Port	The port on which the LLDP frame was received.
• Chassis ID	The Chassis ID is the identification of the neighbor's LLDP frames.
• Remote Port ID	The Remote Port ID is the identification of the neighbor port.
• System Name	System Name is the name advertised by the neighbor unit.
• Port Description	Port Description is the port description advertised by the neighbor unit.
• System Capabilities	<p>System Capabilities describes the neighbor unit's capabilities. The possible capabilities are:</p> <ol style="list-style-type: none"> 1. Other 2. Repeater 3. Bridge 4. WLAN Access Point 5. Router 6. Telephone 7. DOCSIS cable device 8. Station only 9. Reserved <p>When a capability is enabled, the capability is followed by (+). If the capability is disabled, the capability is followed by (-).</p>
• Management Address	Management Address is the neighbor unit's address that is used for higher layer entities to assist the discovery by the network management. This could for instance hold the neighbor's IP address.

Buttons

Auto-refresh : Check this box to refresh the page automatically. Automatic refresh occurs every 3 seconds.

: Click to refresh the page immediately.

4.14.6 Port Statistics

This page provides an overview of all LLDP traffic. Two types of counters are shown. Global counters are counters that refer to the whole stack, switch, while local counters refer to counters for the currently selected switch. The LLDP Statistics screen in Figure 4-14-5 appears.

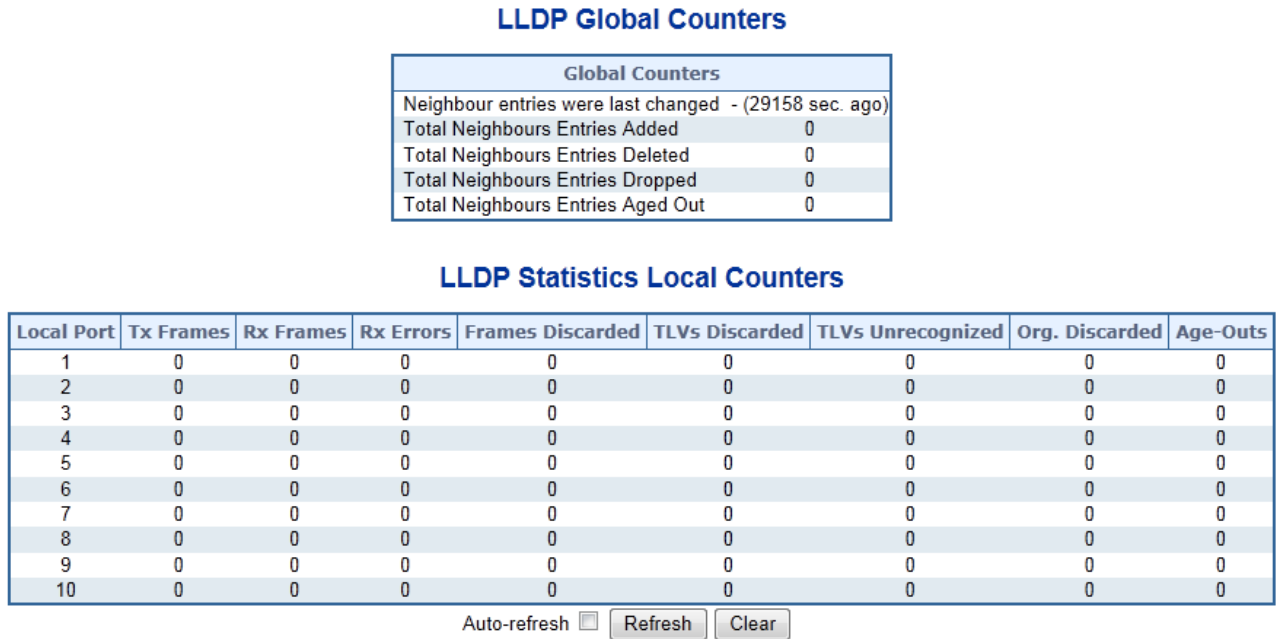

Figure 4-14-5: LLDP Statistics Page Screenshot

The page includes the following fields:

Global Counters

Object	Description
• Neighbor entries were last changed at	It also shows the time when the last entry was last deleted or added. It also shows the time elapsed since the last change was detected.
• Total Neighbors Entries Added	Shows the number of new entries added since switch reboot.
• Total Neighbors Entries Deleted	Shows the number of new entries deleted since switch reboot.
• Total Neighbors Entries Dropped	Shows the number of LLDP frames dropped due to that the entry table was full.
• Total Neighbors Entries Aged Out	Shows the number of entries deleted due to Time-To-Live expiring.

Local Counters

The displayed table contains a row for each port. The columns hold the following information:

Object	Description
• Local Port	The port on which LLDP frames are received or transmitted.
• Tx Frames	The number of LLDP frames transmitted on the port.
• Rx Frames	The number of LLDP frames received on the port.
• Rx Errors	The number of received LLDP frames containing some kind of error.
• Frames Discarded	If an LLDP frame is received on a port, and the switch's internal table has run full, the LLDP frame is counted and discarded. This situation is known as "Too Many Neighbors" in the LLDP standard. LLDP frames require a new entry in the table when the Chassis ID or Remote Port ID is not already contained within the table. Entries are removed from the table when a given port links down, an LLDP shutdown frame is received, or when the entry ages out.
• TLVs Discarded	Each LLDP frame can contain multiple pieces of information, known as TLVs (TLV is short for "Type Length Value"). If a TLV is malformed, it is counted and discarded.
• TLVs Unrecognized	The number of well-formed TLVs, but with an unknown type value.
• Org. Discarded	The number of organizationally TLVs received.
• Age-Outs	Each LLDP frame contains information about how long time the LLDP information is valid (age-out time). If no new LLDP frame is received within the age out time, the LLDP information is removed, and the Age-Out counter is incremented.

Buttons

Auto-refresh : Check this box to refresh the page automatically. Automatic refresh occurs every 3 seconds.

: Click to refresh the page immediately.

: Clears the local counters. All counters (including global counters) are cleared upon reboot.

4.14.7 LLDP Neighbours EEE Information

By using EEE power savings can be achieved at the expense of traffic latency. This latency occurs due to that the circuits EEE turn off to save power, need time to boot up before sending traffic over the link. This time is called "wakeup time". To achieve minimal latency, devices can use LLDP to exchange information about their respective tx and rx "wakeup time", as a way to agree upon the minimum wakeup time they need.

This page provides an overview of EEE information exchanged by LLDP. The LLDP Neighbors EEE Information screen in [Figure 4-14-6](#) appears.

LLDP Neighbors EEE Information

Auto-refresh

Local Port	Tx Tw	Rx Tw	Fallback Receive Tw	Echo Tx Tw	Echo Rx Tw	Resolved Tx Tw	Resolved Rx Tw	EEE in Sync
No LLDP EEE information found								

Figure 4-14-6: LLDP Neighbors EEE Information Page Screenshot

The page includes the following fields:

Object	Description
• Local Port	The port on which LLDP frames are received or transmitted.
• Tx Tw	The link partner's maximum time that transmit path can holdoff sending data after deassertion of LPI.
• Rx Tw	The link partner's time that receiver would like the transmitter to holdoff to allow time for the receiver to wake from sleep.
• Fallback Receive Tw	The link partner's fallback receive Tw. A receiving link partner may inform the transmitter of an alternate desired Tw_sys_tx. Since a receiving link partner is likely to have discrete levels for savings, this provides the transmitter with additional information that it may use for a more efficient allocation. Systems that do not implement this option default the value to be the same as that of the Receive Tw_sys_tx.
• Echo Tx Tw	The link partner's Echo Tx Tw value. The respective echo values shall be defined as the local link partners reflection (echo) of the remote link partners respective values. When a local link partner receives its echoed values from the remote link partner it can determine whether or not the remote link partner has received, registered and processed its most recent values. For example, if the local link partner receives echoed parameters that do not match the values in its local MIB, then the local link partner infers that the remote link partners request was based on stale information.
• Echo Rx Tw	The link partner's Echo Rx Tw value.

<ul style="list-style-type: none"> • Resolved Tx Tw 	<p>The resolved Tx Tw for this link. Note : NOT the link parther</p> <p>The resolved value that is the actual "tx wakeup time " used for this link (based on EEE information exchanged via LLDP).</p>
<ul style="list-style-type: none"> • Resolved Rx Tw 	<p>The resolved Rx Tw for this link. Note : NOT the link parther</p> <p>The resolved value that is the actual "tx wakeup time " used for this link (based on EEE information exchanged via LLDP).</p>
<ul style="list-style-type: none"> • EEE in Sync 	<p>Shows whether the switch and the link partner have agreed on wake times.</p> <p>Red - Switch and link partner have not agreed on wakeup times.</p> <p>Green - Switch and link partner have agreed on wakeup times.</p>

Buttons

Auto-refresh : Check this box to refresh the page automatically. Automatic refresh occurs every 3 seconds.

: Click to refresh the page immediately.

4.15 Diagnostics

This section provide the Physical layer and IP layer network diagnostics tools for troubleshoot. The diagnostic tools are designed for network manager to help them quickly diagnose problems between point to point and better service customers.

Use the Diagnostics menu items to display and configure basic administrative details of the Managed Switch. Under System the following topics are provided to configure and view the system information:

This section has the following items:

- **Ping**
- **IPv6 Ping**
- **Remote IP Ping**
- **Cable Diagnostics**

PING

The ping and IPv6 ping allow you to issue ICMP PING packets to troubleshoot IP connectivity issues. The Managed Switch transmit ICMP packets, and the sequence number and roundtrip time are displayed upon reception of a reply.

Cable Diagnostics

The Cable Diagnostics performing tests on copper cables. These functions have the ability to identify the cable length and operating conditions, and to isolate a variety of common faults that can occur on the Cat5 twisted-pair cabling. There might be two statuses as follow:

- If the link is established on the twisted-pair interface in 1000Base-T mode, the Cable Diagnostics can run without disruption of the link or of any data transfer.
- If the link is established in 100Base-TX or 10Base-T, the Cable Diagnostics cause the link to drop while the diagnostics are running.

After the diagnostics are finished, the link is reestablished. And the following functions are available.

- Coupling between cable pairs.
- Cable pair termination
- Cable Length

4.15.1 Ping

This page allows you to issue ICMP PING packets to troubleshoot IP connectivity issues.

After you press **Start**, 5 ICMP packets are transmitted, and the sequence number and roundtrip time are displayed upon reception of a reply. The page refreshes automatically until responses to all packets are received, or until a timeout occurs. The ICMP Ping screen in [Figure 4-15-1](#) appears.

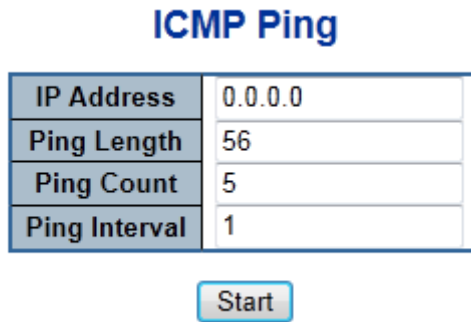
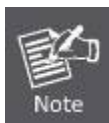

Figure 4-15-1: ICMP Ping Page Screenshot

The page includes the following fields:

Object	Description
• IP Address	The destination IP Address.
• Ping Length	The payload size of the ICMP packet. Values range from 2 bytes to 1452 bytes.
• Ping Count	The count of the ICMP packet. Values range from 1 time to 60 times.
• Ping Interval	The interval of the ICMP packet. Values range from 0 second to 30 seconds.



Be sure the target IP Address is within the same network subnet of the switch, or you had setup the correct gateway IP address.

Button

Start: Click to start transmitting ICMP packets.

New Ping: Click to re-start diagnostics with PING.

4.15.2 IPv6 Ping

This page allows you to issue ICMPv6 PING packets to troubleshoot IPv6 connectivity issues.

After you press “**Start**”, 5 ICMPv6 packets are transmitted, and the sequence number and roundtrip time are displayed upon reception of a reply. The page refreshes automatically until responses to all packets are received, or until a timeout occurs. The ICMPv6 Ping screen in [Figure 4-15-2](#) appears.

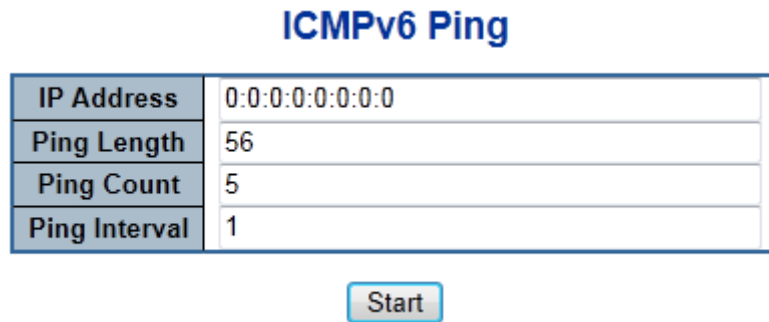

Figure 4-15-2: ICMPv6 Ping Page Screenshot

The page includes the following fields:

Object	Description
• IP Address	The destination IP Address.
• Ping Length	The payload size of the ICMP packet. Values range from 2 bytes to 1452 bytes.
• Ping Count	The count of the ICMP packet. Values range from 1 time to 60 times.
• Ping Interval	The interval of the ICMP packet. Values range from 0 second to 30 seconds.

Button

: Click to start transmitting ICMP packets.

: Click to re-start diagnostics with PING.

4.15.3 Remote IP Ping Test

This page allows you to issue ICMP PING packets to troubleshoot IP connectivity issues on special port.

After you press "Test", 5 ICMP packets are transmitted, and the sequence number and roundtrip time are displayed upon reception of a reply. The page refreshes automatically until responses to all packets are received, or until a timeout occurs. The ICMP Ping screen in [Figure 4-15-3](#) appears.

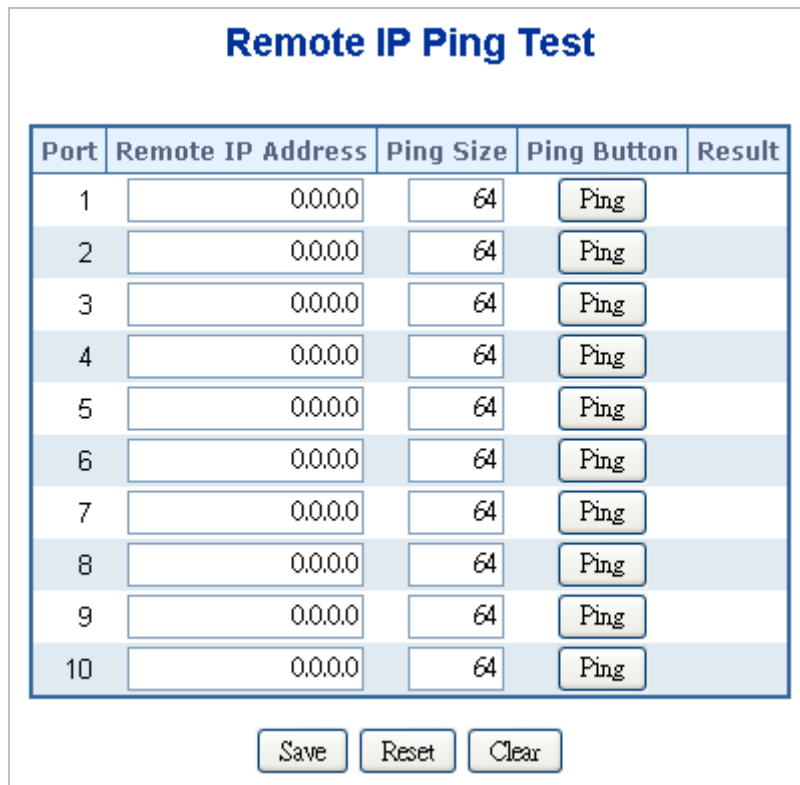

Figure 4-15-3: Remote IP Ping Test Page Screenshot

The page includes the following fields:

Object	Description
<ul style="list-style-type: none"> • Port 	The logical port for the settings.
<ul style="list-style-type: none"> • Remote IP Address 	The destination IP Address.
<ul style="list-style-type: none"> • Ping Size 	The payload size of the ICMP packet. Values range from 8 bytes to 1400 bytes.
<ul style="list-style-type: none"> • Result 	Display the ping result.

Buttons

: Click to start ping process.

: Click to save changes.

: Click to undo any changes made locally and revert to previously saved values.

: Clears the local counters. All counters (including global counters) are cleared upon reboot.

4.15.4 Cable Diagnostics

This page is used for running the Cable Diagnostics.

Press to run the diagnostics. This will take approximately 5 seconds. If all ports are selected, this can take approximately 15 seconds. When completed, the page refreshes automatically, and you can view the cable diagnostics results in the cable status table. Note that Cable Diagnostics is only accurate for cables of length 7 - 140 meters.

10 and 100 Mbps ports will be linked down while running cable diagnostic. Therefore, running cable diagnostic on a 10 or 100 Mbps management port will cause the switch to stop responding until VeriPHY is complete. The ports belong to the currently selected stack unit, as reflected by the page header. The VeriPHY Cable Diagnostics screen in [Figure 4-15-4](#) appears.

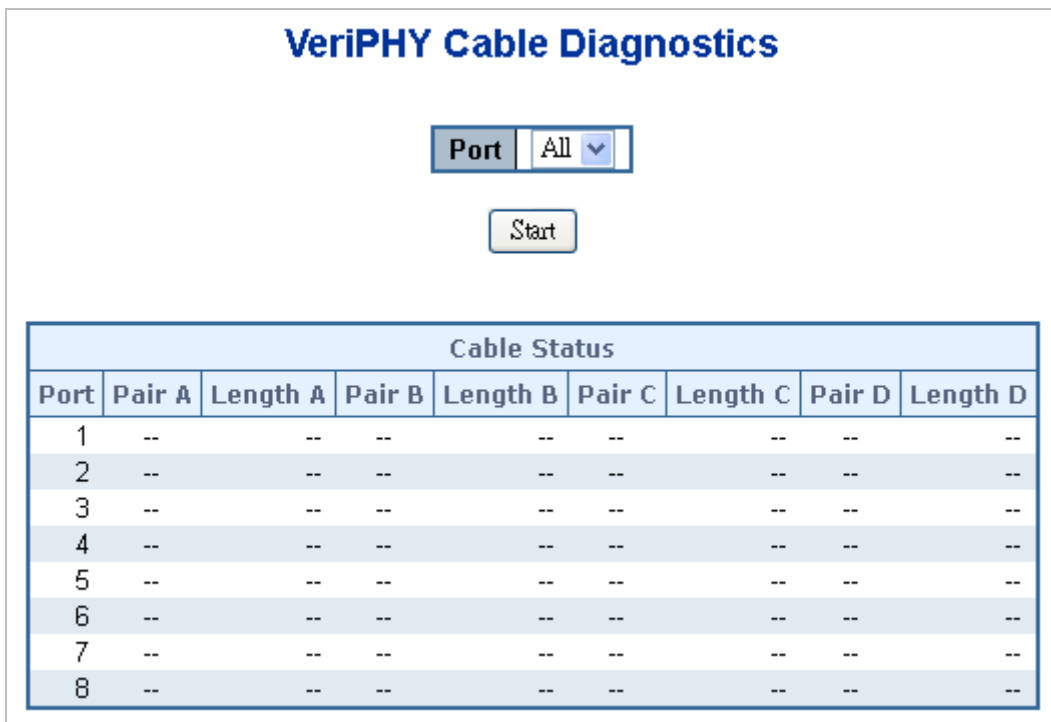

Figure 4-15-4: VeriPHY Cable Diagnostics Page Screenshot

The page includes the following fields:

Object	Description
<ul style="list-style-type: none"> Port 	The port where you are requesting Cable Diagnostics.
<ul style="list-style-type: none"> Cable Status 	<ul style="list-style-type: none"> Port: Port number. Pair: The status of the cable pair. Length: The length (in meters) of the cable pair.

Buttons

Start: Click to run the diagnostics.

4.16 Loop Protection

This page allows the user to inspect the current Loop Protection configurations, and possibly change them as well.

4.16.1 Configuration

This page allows the user to inspect the current Loop Protection configurations,

General Settings

Global Configuration	
Enable Loop Protection	Disable ▾
Transmission Time	5 seconds
Shutdown Time	180 seconds

Port Configuration

Port	Enable	Action	Tx Mode
*	<input type="checkbox"/>	<All> ▾	<All> ▾
1	<input checked="" type="checkbox"/>	Shutdown Port ▾	Enable ▾
2	<input checked="" type="checkbox"/>	Shutdown Port ▾	Enable ▾
3	<input checked="" type="checkbox"/>	Shutdown Port ▾	Enable ▾
4	<input checked="" type="checkbox"/>	Shutdown Port ▾	Enable ▾
5	<input checked="" type="checkbox"/>	Shutdown Port ▾	Enable ▾
6	<input checked="" type="checkbox"/>	Shutdown Port ▾	Enable ▾
7	<input checked="" type="checkbox"/>	Shutdown Port ▾	Enable ▾
8	<input checked="" type="checkbox"/>	Shutdown Port ▾	Enable ▾
9	<input checked="" type="checkbox"/>	Shutdown Port ▾	Enable ▾
10	<input checked="" type="checkbox"/>	Shutdown Port ▾	Enable ▾

Figure 4-16-1: Loop Protection Configuration Page Screenshot

The page includes the following fields:

General Settings:

Object	Description
<ul style="list-style-type: none"> • Enable Loop Protection 	Controls whether loop protections is enabled (as a whole).
<ul style="list-style-type: none"> • Transmission Time 	The interval between each loop protection PDU sent on each port. valid values are 1 to 10 seconds.
<ul style="list-style-type: none"> • Shutdown Time 	The period (in seconds) for which a port will be kept disabled in the event of a loop is detected (and the port action shuts down the port). Valid values are 0 to 604800 seconds (7 days). A value of zero will keep a port disabled (until next device restart).

Port Configuration:

Object	Description
• Port	The switch port number of the port.
• Enable	Controls whether loop protection is enabled on this switch port.
• Action	Configures the action performed when a loop is detected on a port. Valid values are Shutdown Port , Shutdown Port and Log or Log Only .
• Tx Mode	Controls whether or not the port is actively generating loop protection PDU's, or whether or not it is just passively looking for looped PDU's.

Buttons

: Click to save changes.

: Click to undo any changes made locally and revert to previously saved values.

4.16.2 Status

This page displays the loop protection port status the ports from the Industrial Managed Switch.

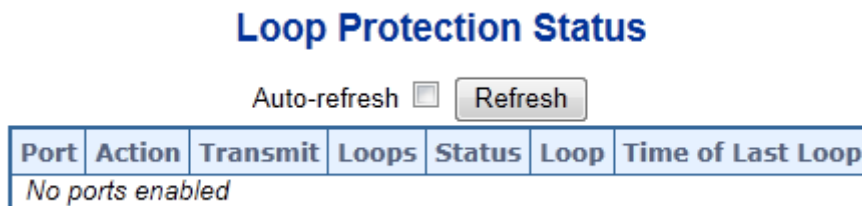

Figure 4-16-2: Loop Protection Status Page Screenshot

The page includes the following fields:

Object	Description
• Port	The switch port number of the logical port.
• Action	The currently configured port action.
• Transmit	The currently configured port transmit mode.
• Loops	The number of loops detected on this port.
• Status	The current loop protection status of the port.
• Loop	Whether a loop is currently detected on the port.
• Time of Last Loop	The time of the last loop event detected.

4.17 RMON

RMON is the most important expansion of the standard SNMP. RMON is a set of MIB definitions, used to define standard network monitor functions and interfaces, enabling the communication between SNMP management terminals and remote monitors. RMON provides a highly efficient method to monitor actions inside the subnets.

MID of RMON consists of 10 groups. The switch supports the most frequently used group 1, 2, 3 and 9:

- **Statistics:** Maintain basic usage and error statistics for each subnet monitored by the Agent.
- **History:** Record periodical statistic samples available from Statistics.
- **Alarm:** Allow management console users to set any count or integer for sample intervals and alert thresholds for RMON Agent records.
- **Event:** A list of all events generated by RMON Agent.

Alarm depends on the implementation of Event. Statistics and History display some current or history subnet statistics. Alarm and Event provide a method to monitor any integer data change in the network, and provide some alerts upon abnormal events (sending Trap or record in logs).

4.17.1 RMON Alarm Configuration

Configure RMON Alarm table on this page. The entry index key is **ID**.; screen in [Figure 4-17-1](#) appears.

Delete	ID	Interval	Variable	Sample Type	Value	Startup Alarm	Rising Threshold	Rising Index	Falling Threshold	Falling Index
--------	----	----------	----------	-------------	-------	---------------	------------------	--------------	-------------------	---------------

Figure 4-17-1: RMON Alarm configuration page screenshot

The page includes the following fields:

Object	Description
• Delete	Check to delete the entry. It will be deleted during the next save.
• ID	Indicates the index of the entry. The range is from 1 to 65535.
• Interval	Indicates the interval in seconds for sampling and comparing the rising and falling threshold. The range is from 1 to 2 ³¹ -1.
52. Variable	Indicates the particular variable to be sampled, the possible variables are: <ul style="list-style-type: none"> ■ InOctets: The total number of octets received on the interface, including framing characters. ■ InUcastPkts: The number of uni-cast packets delivered to a higher-layer protocol. ■ InNUcastPkts: The number of broad-cast and multi-cast packets delivered

	<p>to a higher-layer protocol.</p> <ul style="list-style-type: none"> ■ InDiscards: The number of inbound packets that are discarded even the packets are normal. ■ InErrors: The number of inbound packets that contained errors preventing them from being deliverable to a higher-layer protocol. ■ InUnknownProtos: the number of the inbound packets that were discarded because of the unknown or un-support protocol. ■ OutOctets: The number of octets transmitted out of the interface , including framing characters. ■ OutUcastPkts: The number of uni-cast packets that request to transmit. ■ OutNUcastPkts: The number of broad-cast and multi-cast packets that request to transmit. ■ OutDiscards: The number of outbound packets that are discarded event the packet is normal. ■ OutErrors: The The number of outbound packets that could not be transmitted because of errors. ■ OutQLen: The length of the output packet queue (in packets).
53. Sample Type	<p>The method of sampling the selected variable and calculating the value to be compared against the thresholds, possible sample types are:</p> <ul style="list-style-type: none"> ■ Absolute: Get the sample directly. ■ Delta: Calculate the difference between samples (default).
54. Value	<p>The value of the statistic during the last sampling period.</p>
55. Startup Alarm	<p>The method of sampling the selected variable and calculating the value to be compared against the thresholds, possible sample types are:</p> <ul style="list-style-type: none"> ■ Rising Trigger alarm when the first value is larger than the rising threshold. ■ Falling Trigger alarm when the first value is less than the falling threshold. ■ RisingOrFalling Trigger alarm when the first value is larger than the rising threshold or less than the falling threshold (default).
• Rising Threshold	Rising threshold value (-2147483648-2147483647).
• Rising Index	Rising event index (1-65535).
• Falling Threshold	Falling threshold value (-2147483648-2147483647)
• Falling Index	Falling event index (1-65535).

Buttons

: Click to add a new community entry.

: Click to save changes.

: Click to undo any changes made locally and revert to previously saved values.

4.17.2 RMON Alarm Details

This page provides details of a specific RMON statistics entry; screen in [Figure 4-17-2](#) appears.

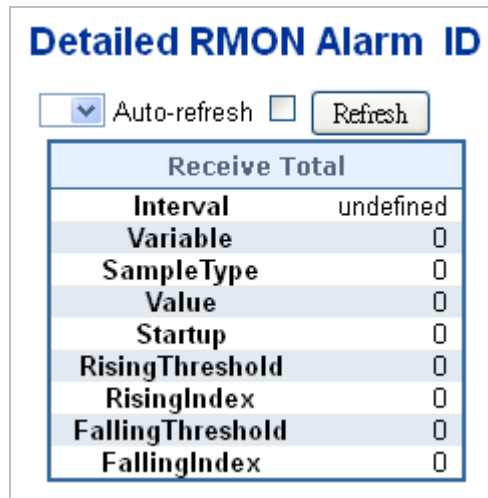

Figure 4-17-2: Detailed RMON Alarm ID page screenshot

The page includes the following fields:

Object	Description
• Interval	Indicates the interval in seconds for sampling and comparing the rising and falling threshold.
• Variable	Indicates the particular variable to be sampled
• Sample Type	The method of sampling the selected variable and calculating the value to be compared against the thresholds.
• Value	The value of the statistic during the last sampling period.
• Startup	The alarm that may be sent when this entry is first set to valid.
• Rising Threshold	Rising threshold value.
• Rising Index	Rising event index.
• Falling Threshold	Falling threshold value.
• Falling Index	Falling event index.

Buttons

Auto-refresh : Check this box to refresh the page automatically. Automatic refresh occurs every 3 seconds.

: Click to refresh the page immediately.

4.17.3 RMON Alarm Status

This page provides an overview of RMON Alarm entries. Each page shows up to 99 entries from the Alarm table, default being 20, selected through the "entries per page" input field. When first visited, the web page will show the first 20 entries from the beginning of the Alarm table. The first displayed will be the one with the lowest ID found in the Alarm table; screen in [Figure 4-17-3](#) appears.

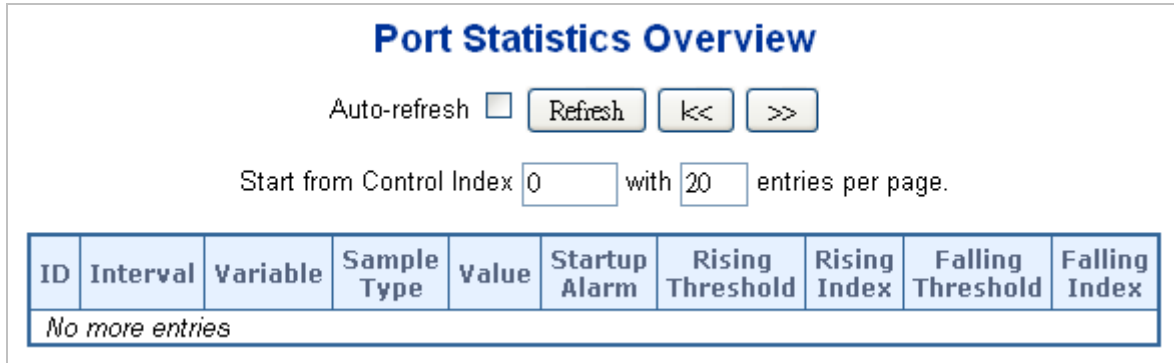

Figure 4-17-3: Port Statistics Overview page screenshot

The page includes the following fields:

Object	Description
• ID	Indicates the index of Alarm control entry.
• Interval	Indicates the interval in seconds for sampling and comparing the rising and falling threshold.
• Variable	Indicates the particular variable to be sampled
• Sample Type	The method of sampling the selected variable and calculating the value to be compared against the thresholds.
• Value	The value of the statistic during the last sampling period.
• Startup Alarm	The alarm that may be sent when this entry is first set to valid.
• Rising Threshold	Rising threshold value.
• Rising Index	Rising event index.
• Falling Threshold	Falling threshold value.
• Falling Index	Falling event index.

Buttons

Auto-refresh : Check this box to refresh the page automatically. Automatic refresh occurs every 3 seconds.

: Click to refresh the page immediately.

: Updates the table starting from the first entry in the Alarm Table, i.e. the entry with the lowest ID.

: Updates the table, starting with the entry after the last entry currently displayed.

4.17.4 RMON Event Configuration

Configure RMON Event table on this page. The entry index key is **ID**; screen in [Figure 4-17-4](#) appears.

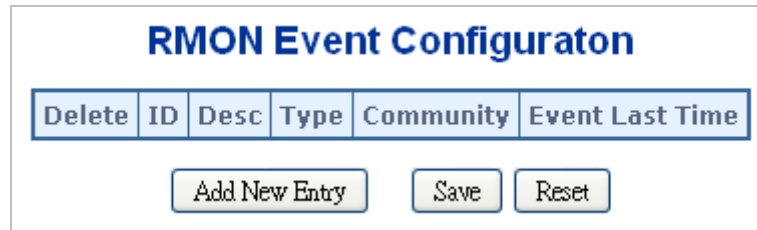

Figure 4-17-4: RMON event configuration page screenshot

The page includes the following fields:

Object	Description
• Delete	Check to delete the entry. It will be deleted during the next save.
• ID	Indicates the index of the entry. The range is from 1 to 65535.
• Desc	Indicates this event, the string length is from 0 to 127, default is a null string.
• Type	Indicates the notification of the event, the possible types are: <ul style="list-style-type: none"> ■ none: The total number of octets received on the interface, including framing characters. ■ log: The number of uni-cast packets delivered to a higher-layer protocol. ■ snmptrap: The number of broad-cast and multi-cast packets delivered to a higher-layer protocol. ■ logandtrap: The number of inbound packets that are discarded even the packets are normal.
• Community	Specify the community when trap is sent, the string length is from 0 to 127, default is "public".
• Event Last Time	Indicates the value of sysUpTime at the time this event entry last generated an event.

Buttons

Add New Entry: Click to add a new community entry.

Save: Click to save changes.

Reset: Click to undo any changes made locally and revert to previously saved values.

4.17.5 RMON Event Details

This page provides an overview of RMON event entries; screen in [Figure 4-17-5](#) appears.

Detailed RMON Event ID

Auto-refresh Refresh

Receive Total	
LogTime	0
LogDescription	0

Figure 4-17-5: Detailed RMON Event ID page screenshot

The page includes the following fields:

Object	Description
• Event Index	Indicates the index of the event entry.
• Log Index	Indicates the index of the log entry.
• LogTime	Indicates Event log time
• LogDescription	Indicates the Event description.

Buttons

Auto-refresh : Check this box to refresh the page automatically. Automatic refresh occurs every 3 seconds.

: Click to refresh the page immediately.

4.17.6 RMON Event Status

This page provides an overview of RMON Event table entries. Each page shows up to 99 entries from the Event table, default being 20, selected through the "entries per page" input field. When first visited, the web page will show the first 20 entries from the beginning of the Event table. The first displayed will be the one with the lowest Event Index and Log Index found in the Event table table; screen in [Figure 4-17-6](#) appears.

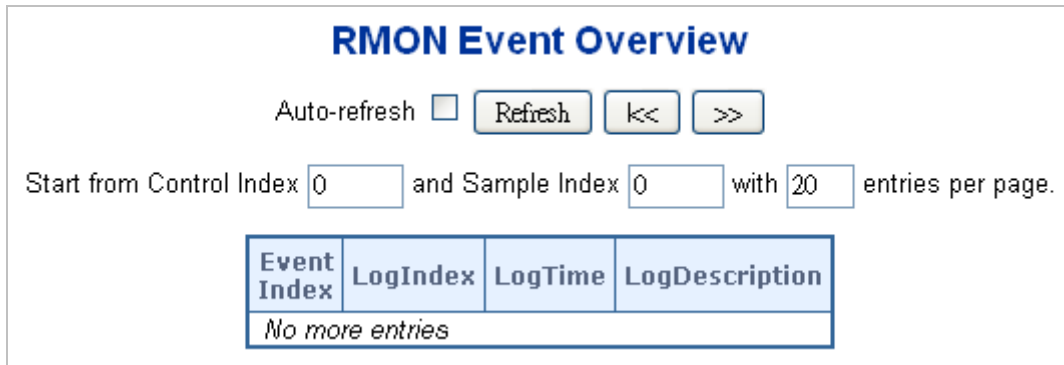

Figure 4-17-6: RMON Event Overview page screenshot

The page includes the following fields:

Object	Description
• Event Index	Indicates the index of the event entry.
• Log Index	Indicates the index of the log entry.
• LogTime	Indicates Event log time
• LogDescription	Indicates the Event description.

Buttons

Auto-refresh : Check this box to refresh the page automatically. Automatic refresh occurs every 3 seconds.

: Click to refresh the page immediately.

: Updates the table starting from the first entry in the Alarm Table, i.e. the entry with the lowest ID.

: Updates the table, starting with the entry after the last entry currently displayed.

4.17.7 RMON History Configuration

Configure RMON History table on this page. The entry index key is **ID**; screen in [Figure 4-17-7](#) appears.

Delete	ID	Data Source	Interval	Buckets	Buckets Granted
--------	----	-------------	----------	---------	-----------------

Figure 4-17-7: RMON history configuration page screenshot

The page includes the following fields:

Object	Description
• Delete	Check to delete the entry. It will be deleted during the next save.
• ID	Indicates the index of the entry. The range is from 1 to 65535.
• Data Source	Indicates the port ID which wants to be monitored. If in stacking switch, the value must add 1000*(switch ID-1), for example, if the port is switch 3 port 5, the value is 2005.
• Interval	Indicates the interval in seconds for sampling the history statistics data. The range is from 1 to 3600, default value is 1800 seconds.
• Buckets	Indicates the maximum data entries associated this History control entry stored in RMON. The range is from 1 to 3600, default value is 50.
• Buckets Granted	The number of data will be saved in the RMON.

Buttons

: Click to add a new community entry.

: Click to save changes.

: Click to undo any changes made locally and revert to previously saved values.

4.17.8 RMON History Details

This page provides details of RMON history entries; screen in [Figure 4-17-8](#) appears.

Receive Total	
SampleStart	0
Drops	0
Octets	0
Pkts	0
Broadcast	0
Multicast	0
CRC/Alignment	0
Undersize	0
Oversize	0
Fragments	0
Jabber	0
Collisions	0
Utilization	0

Figure 4-17-8: RMON history detailed page screenshot

The page includes the following fields:

Object	Description
• History Index	Indicates the index of History control entry.
• Sample Index	Indicates the index of the data entry associated with the control entry
• Sample Start	The total number of events in which packets were dropped by the probe due to lack of resources.
• Drops	The total number of events in which packets were dropped by the probe due to lack of resources.
• Octets	The total number of octets of data (including those in bad packets) received on the network.
• Pkts	The total number of packets (including bad packets, broadcast packets, and multicast packets) received.
• Broadcast	The total number of good packets received that were directed to the broadcast address.
• Multicast	The total number of good packets received that were directed to a multicast address.
• CRC / Alignment	The total number of packets received that had a length (excluding framing bits, but including FCS octets) of between 64 and 1518 octets.
• Undersize	The total number of packets received that were less than 64 octets.

• Oversize	The total number of packets received that were longer than 1518 octets.
• Fragments	The number of frames which size is less than 64 octets received with invalid CRC.
• Jabber	The number of frames which size is larger than 64 octets received with invalid CRC.
• Collisions	The best estimate of the total number of collisions on this Ethernet segment.
• Utilization	The best estimate of the mean physical layer network utilization on this interface during this sampling interval, in hundredths of a percent.

Buttons

Auto-refresh : Check this box to refresh the page automatically. Automatic refresh occurs every 3 seconds.

: Click to refresh the page immediately.

4.17.9 RMON History Status

This page provides an overview of RMON History entries. Each page shows up to 99 entries from the History table, default being 20, selected through the "entries per page" input field. When first visited, the web page will show the first 20 entries from the beginning of the History table. The first displayed will be the one with the lowest History Index and Sample Index found in the History table; screen in [Figure 4-17-9](#) appears.

RMON History Overview

Auto-refresh

Start from Control Index and Sample Index with entries per page.

History Index	Sample Index	Sample Start	Drop	Octets	Pkts	Broad-cast	Multi-cast	CRC Errors	Under-size	Over-size	Frag.	Jabb.	Coll.	Utilization
<i>No more entries</i>														

Figure 4-17-9: RMON history overview page screenshot

The page includes the following fields:

Object	Description
• History Index	Indicates the index of History control entry.
• Sample Index	Indicates the index of the data entry associated with the control entry
• Sample Start	The total number of events in which packets were dropped by the probe due to lack of resources.
• Drops	The total number of events in which packets were dropped by the probe due to lack of resources.

• Octets	The total number of octets of data (including those in bad packets) received on the network.
• Pkts	The total number of packets (including bad packets, broadcast packets, and multicast packets) received.
• Broadcast	The total number of good packets received that were directed to the broadcast address.
• Multicast	The total number of good packets received that were directed to a multicast address.
• CRCErrors	The total number of packets received that had a length (excluding framing bits, but including FCS octets) of between 64 and 1518 octets.
• Undersize	The total number of packets received that were less than 64 octets.
• Oversize	The total number of packets received that were longer than 1518 octets.
• Frag.	The number of frames which size is less than 64 octets received with invalid CRC.
• Jabb.	The number of frames which size is larger than 64 octets received with invalid CRC.
• Coll.	The best estimate of the total number of collisions on this Ethernet segment.
• Utilization	The best estimate of the mean physical layer network utilization on this interface during this sampling interval, in hundredths of a percent.

Buttons

Auto-refresh : Check this box to refresh the page automatically. Automatic refresh occurs every 3 seconds.

: Click to refresh the page immediately.

: Updates the table starting from the first entry in the Alarm Table, i.e. the entry with the lowest ID.

: Updates the table, starting with the entry after the last entry currently displayed.

4.17.10 RMON Statistics Configuration

Configure RMON Statistics table on this page. The entry index key is **ID**; screen in [Figure 4-17-10](#) appears.



Figure 4-17-10: RMON Statistics Configuration Page screenshot

The page includes the following fields:

Object	Description
<ul style="list-style-type: none"> • Delete 	Check to delete the entry. It will be deleted during the next save.
<ul style="list-style-type: none"> • ID 	Indicates the index of the entry. The range is from 1 to 65535.
<ul style="list-style-type: none"> • Data Source 	Indicates the port ID which wants to be monitored. If in stacking switch, the value must add 1000*(switch ID-1), for example, if the port is switch 3 port 5, the value is 2005

Buttons

Add New Entry: Click to add a new community entry.

Save: Click to save changes.

Reset: Click to undo any changes made locally and revert to previously saved values.

4.17.11 RMON Statistics Details

This page provides details of a specific RMON statistics entry; screen in [Figure 4-17-11](#) appears.

Receive Total	
Port	undefined
Drops	0
Octets	0
Pkts	0
Broadcast	0
Multicast	0
CRC/Alignment	0
Undersize	0
Oversize	0
Fragments	0
Jabber	0
Collisions	0
64 Bytes	0
65-127 Bytes	0
128-255 Bytes	0
256-511 Bytes	0
512-1023 Bytes	0
1024-1518 Bytes	0

Figure 4-17-11: Loop protection configuration page screenshot

The page includes the following fields:

Object	Description
• Data Source	The port ID which wants to be monitored.
• Drop	The total number of events in which packets were dropped by the probe due to lack of resources.
• Octets	The total number of octets of data (including those in bad packets) received on the network.
• Pkts	The total number of packets (including bad packets, broadcast packets, and multicast packets) received.
• Broad-cast	The total number of good packets received that were directed to the broadcast address.
• Multi-cast	The total number of good packets received that were directed to a multicast address.
• CRC / Alignment	The total number of packets received that had a length (excluding framing bits, but including FCS octets) of between 64 and 1518 octets.
• Under-size	The total number of packets received that were less than 64 octets.

• Over-size	The total number of packets received that were longer than 1518 octets.
• Frag.	The number of frames which size is less than 64 octets received with invalid CRC.
• Jabb.	The number of frames which size is larger than 64 octets received with invalid CRC.
• Coll.	The best estimate of the total number of collisions on this Ethernet segment.
• 64	The total number of packets (including bad packets) received that were 64 octets in length.
• 65~127	The total number of packets (including bad packets) received that were between 65 to 127 octets in length.
• 128~255	The total number of packets (including bad packets) received that were between 128 to 255 octets in length.
• 256~511	The total number of packets (including bad packets) received that were between 256 to 511 octets in length.
• 512~1023	The total number of packets (including bad packets) received that were between 512 to 1023 octets in length.
• 1024~1588	The total number of packets (including bad packets) received that were between 1024 to 1588 octets in length.

Buttons

Auto-refresh : Check this box to refresh the page automatically. Automatic refresh occurs every 3 seconds.

: Click to refresh the page immediately.

4.18 Precision Time Protocol

4.18.1 PTP Configuration

This section allows the user to configure and inspect the current Precision Time Protocol (PTP) clock settings.

PTP External Clock Mode

One_PPS_Mode	Disable
External Enable	False
VCXO Enable	False
Clock Frequency	1

Figure 4-18-1: PTP Clock configuration page screenshot

The page includes the following fields:

Object	Description
<ul style="list-style-type: none"> • One_PPS_Mode 	<p>This Selection box will allow you to select the One_pps_mode configuration.</p> <p>The following values are possible:</p> <ol style="list-style-type: none"> 1. Output : Enable the 1 pps clock output 2. Input : Enable the 1 pps clock input 3. Disable : Disable the 1 pps clock in/out-put
<ul style="list-style-type: none"> • External Enable 	<p>This Selection box will allow you to configure the External Clock output.</p> <p>The following values are possible:</p> <ol style="list-style-type: none"> 1. True : Enable the external clock output 2. False : Disable the external clock output
<ul style="list-style-type: none"> • VCXO_Enable 	<p>This Selection box will allow you to configure the External VCXO rate adjustment.</p> <p>The following values are possible:</p> <ol style="list-style-type: none"> 1. True : Enable the external VCXO rate adjustment 2. False : Disable the external VCXO rate adjustment
<ul style="list-style-type: none"> • Clock Frequency 	<p>This will allow setting the Clock Frequency.</p> <p>The possible range of values are 1 - 25000000 (1 - 25MHz)</p>

PTP Clock Configuration

			Port List									
Delete	Clock Instance	Device Type	1	2	3	4	5	6	7	8	9	10
No Clock Instances Present												

Add New PTP Clock
Save
Reset

Figure 4-18-2: PTP Clock configuration page screenshot

The page includes the following fields:

Object	Description
<ul style="list-style-type: none"> • Delete 	Check this box and click on 'Save' to delete the clock instance.
<ul style="list-style-type: none"> • Clock Instance 	Indicates the Instance of a particular Clock Instance [0..3]. Click on the Clock Instance number to edit the Clock details.
<ul style="list-style-type: none"> • Device Type 	Indicates the Type of the Clock Instance. There are five Device Types. <ol style="list-style-type: none"> 1. Ord-Bound - clock's Device Type is Ordinary-Boundary Clock. 2. P2p Transp - clock's Device Type is Peer to Peer Transparent Clock. 3. E2e Transp - clock's Device Type is End to End Transparent Clock. 4. Master Only - clock's Device Type is Master Only. 5. Slave Only - clock's Device Type is Slave Only.
<ul style="list-style-type: none"> • Port List 	Set check mark for each port configured for this Clock Instance.

Buttons

Add New PTP Clock : Click to create a new clock instance.

Save : Click to save the page immediately.

Reset : Click to reset the the page immediately.

4.18.2 PTP Status

This section allows the user to inspect the current Precision Time Protocol (PTP) clock settings.

PTP External Clock Mode

One PPS Mode	Disable
External Enable	False
VCXO Enable	False
Clock Frequency	1

PTP Clock Configuration

Auto-refresh

		Port List									
Clock Instance	Device Type	1	2	3	4	5	6	7	8	9	10
No Clock Instances Present											

Figure 4-18-3: PTP Clock Status page screenshot

The page includes the following fields:

Object	Description
<ul style="list-style-type: none"> • One_pps_mode 	Shows the current One_pps_mode configured. <ol style="list-style-type: none"> 1. Output : Enable the 1 pps clock output 2. Input : Enable the 1 pps clock input 3. Disable : Disable the 1 pps clock in/out-put
<ul style="list-style-type: none"> • External Enable 	Shows the current External clock output configuration. <ol style="list-style-type: none"> 1. True : Enable the external clock output 2. False : Disable the external clock output
<ul style="list-style-type: none"> • VCXO_Enable 	Shows the current VCXO rate adjustment configuration. <ol style="list-style-type: none"> 1. True : Enable the external VCXO rate adjustment 2. False : Disable the external VCXO rate adjustment
<ul style="list-style-type: none"> • Clock Frequency 	Shows the current clock frequency used by the External Clock. The possible range of values are 1 - 25000000 (1 - 25MHz)
<ul style="list-style-type: none"> • Clock Instance 	Indicates the Instance of a particular Clock Instance [0..3]. Click on the Clock Instance number to monitor the Clock details
<ul style="list-style-type: none"> • Device Type 	Indicates the Type of the Clock Instance. There are five Device Types. <ol style="list-style-type: none"> 1. Ord-Bound - Clock's Device Type is Ordinary-Boundary Clock. 2. P2p Transp - Clock's Device Type is Peer to Peer Transparent Clock.

	<ul style="list-style-type: none">3. E2e Transp - Clock's Device Type is End to End Transparent Clock.4. Master Only - Clock's Device Type is Master Only.5. Slave Only - Clock's Device Type is Slave Only.
<ul style="list-style-type: none">• Port List	Shows the ports configured for that Clock Instance.

Buttons

Auto-refresh : Check this box to refresh the page automatically. Automatic refresh occurs every 6 seconds.

: Click to refresh the page immediately.

4.19 Ring

ITU-T G.8032 **Ethernet Ring protection switching (ERPS)** is a link layer protocol applied on Ethernet loop protection to provide sub-50ms protection and recovery switching for Ethernet traffic in a ring topology.

ERPS provides a faster redundant recovery than Spanning Tree topology. The action is similar to STP or RSTP, but the algorithms between them are not the same. In the Ring topology, every switch should be enabled with Ring function and two ports should be assigned as the member ports in the ERPS. Only one switch in the Ring group would be set as the RPL owner switch that one port would be blocked, called **owner port**, and PRL neighbour switch has one port that one port would be blocked, called **neighbour port** that connect to owner port directly and this link is called the **Ring Protection Link** or **RPL**. Each switch will send ETH-CCM message to check the link status in the ring group. When the failure of network connection occurs, the nodes block the failed link and report the signal failure message, the RPL owner switch will automatically unblocks the PRL to recover from the failure.

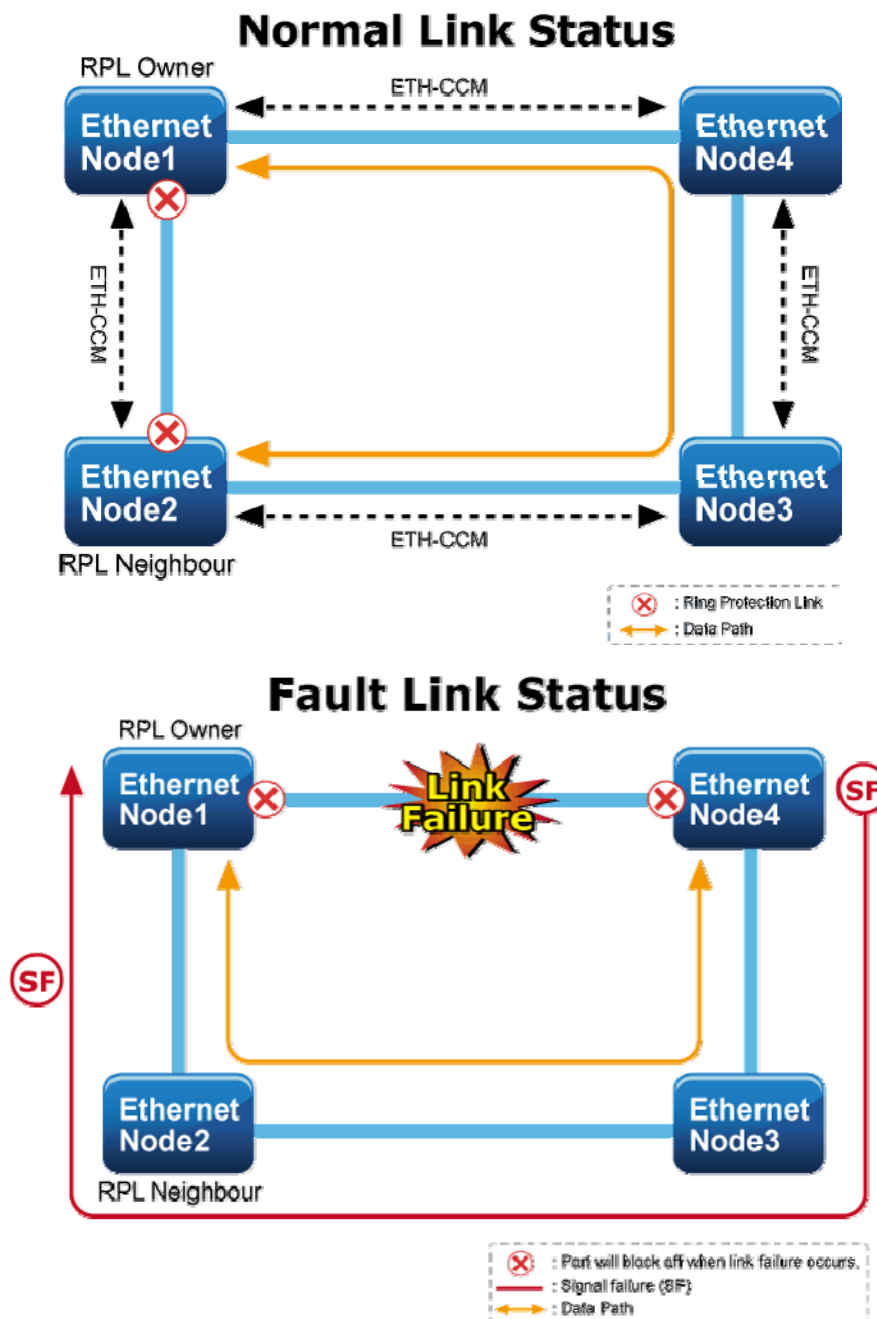

4.19.1 MEP Configuration

The Maintenance Entity Point instances are configured here; screen in [Figure 4-19-1](#) appears.

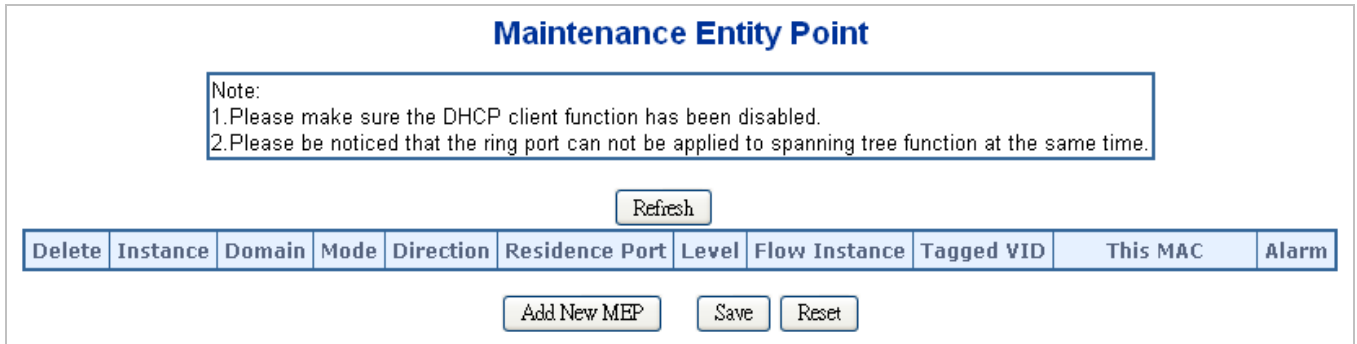

Figure 4-19-1: MEP configuration page screenshot

The page includes the following fields:

Object	Description
• Delete	This box is used to mark a MEP for deletion in next Save operation.
• Instance	The ID of the MEP. Click on the ID of a MEP to enter the configuration page.
• Domain	<ul style="list-style-type: none"> ■ Port: This is a MEP in the Port Domain. 'Flow Instance' is a Port. ■ Esp: Future use ■ Evc: This is a MEP in the EVC Domain. 'Flow Instance' is a EVC ■ Mpls: Future use
• Mode	<ul style="list-style-type: none"> ■ MEP: This is a Maintenance Entity End Point. ■ MIP: This is a Maintenance Entity Intermediate Point.
• Direction	<ul style="list-style-type: none"> ■ Ingress: This is a Ingress (down) MEP - monitoring ingress traffic on 'Residence Port'. ■ Egress: This is a Egress (up) MEP - monitoring egress traffic on 'Residence Port'.
• Residence Port	The port where MEP is monitoring - see 'Direction'.
• Level	The MEG level of this MEP.
• Flow Instance	The MEP is related to this flow - See 'Domain'.
• Tagged VID	<p>Port MEP: An outer C/S-tag (depending on VLAN Port Type) is added with this VID.</p> <p>Entering '0' means no TAG added.</p>
• This MAC	The MAC of this MEP - can be used by other MEP when unicast is selected (Info only).
• Alarm	There is an active alarm on the MEP.

Buttons

Add New MEP: Click to add a new MEP entry

Refresh: Click to refresh the page immediately.

Save: Click to save changes.

Reset: Click to undo any changes made locally and revert to previously saved values.

4.19.2 Detailed MEP Configuration

This page allows the user to inspect and configure the current MEP Instance.; screen in [Figure 4-19-2](#) appears.

MEP Configuration

Instance Data

MEP Instance	Domain	Mode	Direction	Residence Port	Flow Instance	Tagged VID	EPS Instance	This MAC
1	Port	Mep	Ingress	1	1	10	0	00-30-4F-A8-E9-AE

Instance Configuration

Level	Format	ICC/Domain Name	MEG ID	MEP ID	Tagged VID		cLevel	cMEG	cMEP	cAIS	cLCK	cSSF	aBLK	aTSF
0	ITU ICC	planet	meg000	0	10		●	●	●	●	●	●	●	●

Peer MEP Configuration

Delete	Peer MEP ID	Unicast Peer MAC		cLOC	cRDI	cPeriod	cPriority
No Peer MEP Added							

Functional Configuration

Continuity Check			APS Protocol				
Enable	Priority	Frame rate	Enable	Priority	Cast	Type	Last Octet
<input type="checkbox"/>	0	1 fsec	<input type="checkbox"/>	0	Multi	R-APS	1

Figure 4-19-2: Detail MEP configuration page screenshot

The page includes the following fields:

Instance Data:

Object	Description
• MEP Instance	The ID of the MEP.
• Domain	See help on MEP create WEB.
• Mode	See help on MEP create WEB.
• Direction	See help on MEP create WEB.

• Residence Port	See help on MEP create WEB.
• Flow Instance	See help on MEP create WEB.
• Tagged VID	See help on MEP create WEB.
• This MAC	See help on MEP create WEB.

Instance Configuration:

Object	Description
• Level	See help on MEP create WEB.
• Format	This is the configuration of the two possible Maintenance Association Identifier formats. ITU ICC: This is defined by ITU. 'ICC' can be max. 6 char. 'MEG id' can be max. 7 char. IEEE String: This is defined by IEEE. 'Domain Name' can be max. 8 char. 'MEG id' can be max. 8 char.
• ICC/Domain Name	This is either ITU ICC (MEG ID value[1-6]) or IEEE Maintenance Domain Name - depending on 'Format'. See 'Format'.
• MEG Id	This is either ITU UMC (MEG ID value[7-13]) or IEEE Short MA Name - depending on 'Format'. See 'Format'. In case of ITU ICC format this can be max. 7 char. If only 6 char. is entered the MEG ID value[13] will become NULL.
• MEP Id	This value will become the transmitted two byte CCM MEP ID.
• cLevel	Fault Cause indicating that a CCM is received with a lower level than the configured for this MEP.
• cMEG	Fault Cause indicating that a CCM is received with a MEG ID different from configured for this MEP.
• cMEP	Fault Cause indicating that a CCM is received with a MEP ID different from all 'Peer MEP ID' configured for this MEP.
• cAIS	Fault Cause indicating that AIS PDU is received.
• cLCK	Fault Cause indicating that LCK PDU is received.
• cSSF	Fault Cause indicating that server layer is indicating Signal Fail.
• aBLK	The consequent action of blocking service frames in this flow is active.
• aTSF	The consequent action of indicating Trail Signal Fail to-wards protection is active.
• Delete	This box is used to mark a Peer MEP for deletion in next Save operation.
• Peer MEP ID	This value will become an expected MEP ID in a received CCM - see 'cMEP'.

• Unicast Peer MAC	This MAC will be used when unicast is selected with this peer MEP. Also this MAC is used to create HW checking of receiving CCM PDU (LOC detection) from this MEP.
• cLOC	Fault Cause indicating that no CCM has been received (in 3,5 periods) - from this peer MEP.
• cRDI	Fault Cause indicating that a CCM is received with Remote Defect Indication - from this peer MEP.
• cPeriod	Fault Cause indicating that a CCM is received with a period different what is configured for this MEP - from this peer MEP.
• cPriority	Fault Cause indicating that a CCM is received with a priority different what is configured for this MEP - from this peer MEP.

Buttons

: Click to add a new peer MEP.

Functional Configuration

Instance Data:

Object	Description
• Enable	Continuity Check based on transmitting/receiving CCM PDU can be enabled/disabled. The CCM PDU is always transmitted as Multi-cast Class 1.
• Priority	The priority to be inserted as PCP bits in TAG (if any). In case of enable of Continuity Check and Loss Measurement both implemented on SW based CCM, 'Priority' has to be the same.
• Frame rate	<p>Selecting the frame rate of CCM PDU. This is the inverse of transmission period as described in Y.1731. This value has the following uses:</p> <ul style="list-style-type: none"> * The transmission rate of the CCM PDU. * Fault Cause cLOC is declared if no CCM PDU has been received within 3.5 periods - see 'cLOC'. * Fault Cause cPeriod is declared if a CCM PDU has been received with different period - see 'cPeriod'. <p>Selecting 300f/sec or 100f/sec will configure HW based CCM (if possible). Selecting other frame rates will configure SW based CCM. In case of enable of Continuity Check and Loss Measurement both implemented on SW based CCM, 'Frame Rate' has to be the same.</p>

APS Protocol:

Object	Description
<ul style="list-style-type: none"> • Enable 	Automatic Protection Switching protocol information transportation based on transmitting/receiving R-APS/L-APS PDU can be enabled/disabled. Must be enabled to support ERPS/ELPS implementing APS. This is only valid with one Peer MEP configured.
<ul style="list-style-type: none"> • Priority 	The priority to be inserted as PCP bits in TAG (if any).
<ul style="list-style-type: none"> • Cast 	Selection of APS PDU transmitted unicast or multi-cast. The unicast MAC will be taken from the 'Unicast Peer MAC' configuration. Unicast is only valid for L-APS - see 'Type'. The R-APS PDU is always transmitted with multi-cast MAC described in G.8032.
<ul style="list-style-type: none"> • Type 	<p>R-APS: APS PDU is transmitted as R-APS - this is for ERPS.</p> <p>L-APS: APS PDU is transmitted as L-APS - this is for ELPS.</p>
<ul style="list-style-type: none"> • Last Octet 	This is the last octet of the transmitted and expected RAPS multi-cast MAC. In G.8031 (03/2010) a RAPS multi-cast MAC is defined as 01-19-A7-00-00-XX. In current standard the value for this last octet is '01' and the usage of other values is for further study.

Buttons

- : Click to go to Fault Management page.
- : Click to go to Performance Monitor page.
- : Click to refresh the page immediately.
- : Click to save changes.
- : Click to undo any changes made locally and revert to previously saved values.

4.19.3 Ethernet Ring Protocol Switch

The Ethernet Ring Protection Switch instances are configured here; screen in [Figure 4-19-3](#) appears.

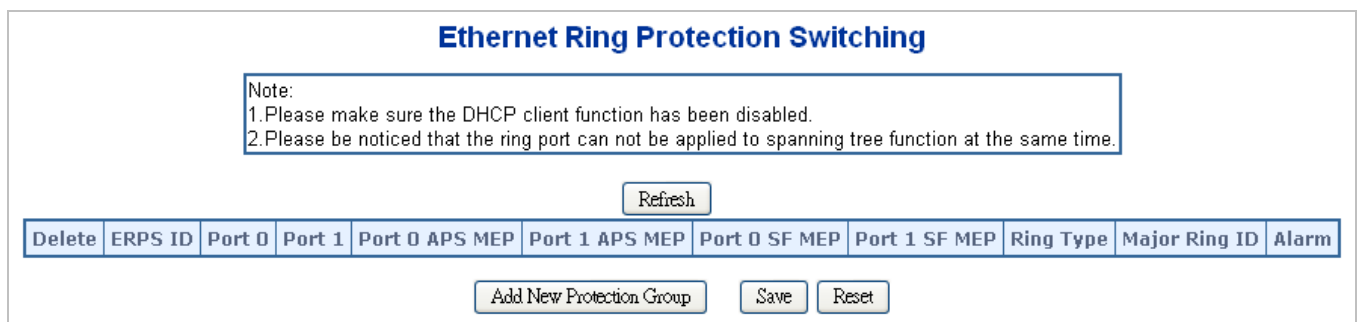

Figure 4-19-3: Ethernet Ring Protocol Switch page screenshot

The page includes the following fields:

Object	Description
• Delete	This box is used to mark an ERPS for deletion in next Save operation.
• Port 0	This will create a Port 0 of the switch in the ring.
• Port 1	This will create "Port 1" of the switch in the Ring. As interconnected sub-ring will have only one ring port, "Port 1" is configured as "0" for interconnected sub-ring. "0" in this field indicates that no "Port 1" is associated with this instance
• Port 0 SF MEP	The Port 0 Signal Fail reporting MEP.
• Port 1 SF MEP	The Port 1 Signal Fail reporting MEP. As only one SF MEP is associated with interconnected sub-ring without virtual channel, it is configured as "0" for such ring instances. "0" in this field indicates that no Port 1 SF MEP is associated with this instance.
• Port 0 APS MEP	The Port 0 APS PDU handling MEP.
• Port 1 APS MEP	The Port 1 APS PDU handling MEP. As only one APS MEP is associated with interconnected sub-ring without virtual channel, it is configured as "0" for such ring instances. "0" in this field indicates that no Port 1 APS MEP is associated with this instance.
• Ring Type	Type of Protecting ring. It can be either major ring or sub-ring.
• Major Ring ID	Major ring group ID for the interconnected sub-ring. It is used to send topology change updates on major ring. If ring is major, this value is same as the protection group ID of this ring.
• Alarm	There is an active alarm on the ERPS.

Buttons

: Click to add a new Protection group entry.

: Click to refresh the page immediately.

: Click to save changes.

: Click to undo any changes made locally and revert to previously saved values.

4.19.4 Ethernet Ring Protocol Switch Configuration

This page allows the user to inspect and configure the current ERPS Instance; screen in [Figure 4-19-4](#) appears.

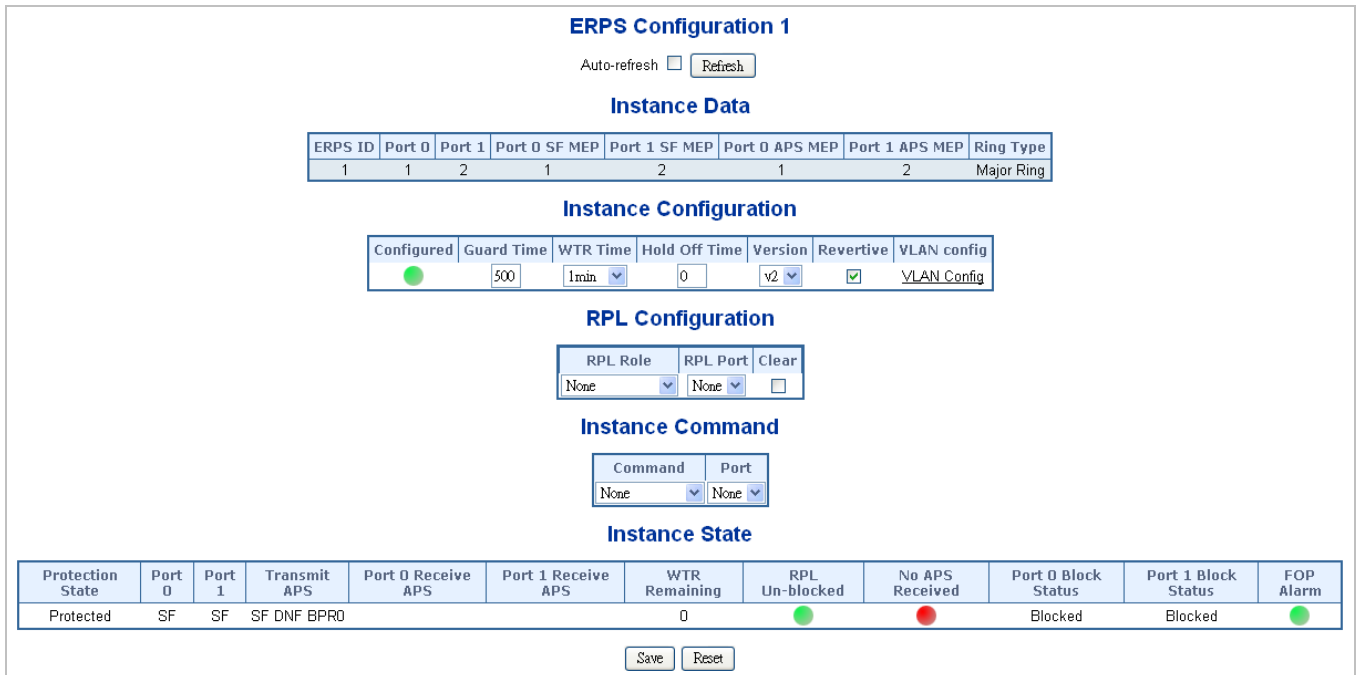

Figure 4-19-4: Ethernet Ring Protocol Switch Configuration page screenshot

The page includes the following fields:

Instance Data:

Object	Description
• ERPS ID	The ID of the Protection group.
• Port 0	See help on ERPS create WEB.
• Port 1	See help on ERPS create WEB.
• Port 0 SF MEP	See help on ERPS create WEB.
• Port 1 SF MEP	See help on ERPS create WEB.
• Port 0 APS MEP	See help on ERPS create WEB.
• Port 1 APS MEP	See help on ERPS create WEB.
• Ring Type	Type of Protecting ring. It can be either major ring or sub-ring.

Instance Configuration:

Object	Description
• Configuration	Red: This ERPS is only created and has not yet been configured - is not active.

	Green: This ERPS is configured - is active.
<ul style="list-style-type: none"> • Guard Time 	<p>Guard timeout value to be used to prevent ring nodes from receiving outdated R-APS messages.</p> <p>The period of the guard timer can be configured in 10 ms steps between 10 ms and 2 seconds, with a default value of 500 ms</p>
<ul style="list-style-type: none"> • WTR Time 	<p>The Wait To Restore timing value to be used in revertive switching.</p> <p>The period of the WTR time can be configured by the operator in 1 minute steps between 5 and 12 minutes with a default value of 5 minutes.</p>
<ul style="list-style-type: none"> • Hold Off Time 	<p>The timing value to be used to make persistent check on Signal Fail before switching.</p> <p>The range of the hold off timer is 0 to 10 seconds in steps of 100 ms</p>
<ul style="list-style-type: none"> • Version 	ERPS Protocol Version - v1 or v2
<ul style="list-style-type: none"> • Revertive 	<p>In Revertive mode, after the conditions causing a protection switch has cleared, the traffic channel is restored to the working transport entity, i.e., blocked on the RPL.</p> <p>In Non-Revertive mode, the traffic channel continues to use the RPL, if it is not failed, after a protection switch condition has cleared.</p>
<ul style="list-style-type: none"> • VLAN Config 	VLAN configuration of the Protection Group. Click on the "VLAN Config" link to confure VLANs for this protection group.

PRL Configuration:

Object	Description
<ul style="list-style-type: none"> • PRL Role 	It can be either RPL owner or RPL Neighbour.
<ul style="list-style-type: none"> • PRL Port 	This allows to select the east port or west port as the RPL block.
<ul style="list-style-type: none"> • Clear 	If the owner has to be changed, then the clear check box allows to clear the RPL owner for that ERPS ring.

Instance Command:

Object	Description
<ul style="list-style-type: none"> • Command 	Administrative command. A port can be administratively configured to be in either manual switch or forced switch state.
<ul style="list-style-type: none"> • Port 	Port selection - Port0 or Port1 of the protection Group on which the command is applied.

Instance State:

Object	Description
• Protection State	ERPS state according to State Transition Tables in G.8032.
• Port 0	OK: State of East port is ok SF: State of East port is Signal Fail
• Port 1	OK: State of West port is ok SF: State of West port is Signal Fail
• Transmit APS	The transmitted APS according to State Transition Tables in G.8032.
• Port 0 Receive APS	The received APS on Port 0 according to State Transition Tables in G.8032.
• Port 1 Receive APS	The received APS on Port 1 according to State Transition Tables in G.8032.
• WTR Remaining	Remaining WTR timeout in milliseconds.
• RPL Un-blocked	APS is received on the working flow.
• No APS Received	RAPS PDU is not received from the other end.
• Port 0 Block Status	Block status for Port 0 (Both traffic and R-APS block status). R-APS channel is never blocked on sub-rings without virtual channel.
• Port 1 Block Status	Block status for Port 1 (Both traffic and R-APS block status). R-APS channel is never blocked on sub-rings without virtual channel.
• FOP Alarm	Failure of Protocol Defect(FOP) status. If FOP is detected, red LED glows; else green LED glows.

Buttons

: Click to save changes.

Auto-refresh : Check this box to refresh the page automatically. Automatic refresh occurs every 6 seconds.

: Click to refresh the page immediately.

: Click to undo any changes made locally and revert to previously saved values.

4.19.5 Ring Wizard

This page allows the user to configure the ERPS by wizard; screen in [Figure 4-19-4](#) appears.

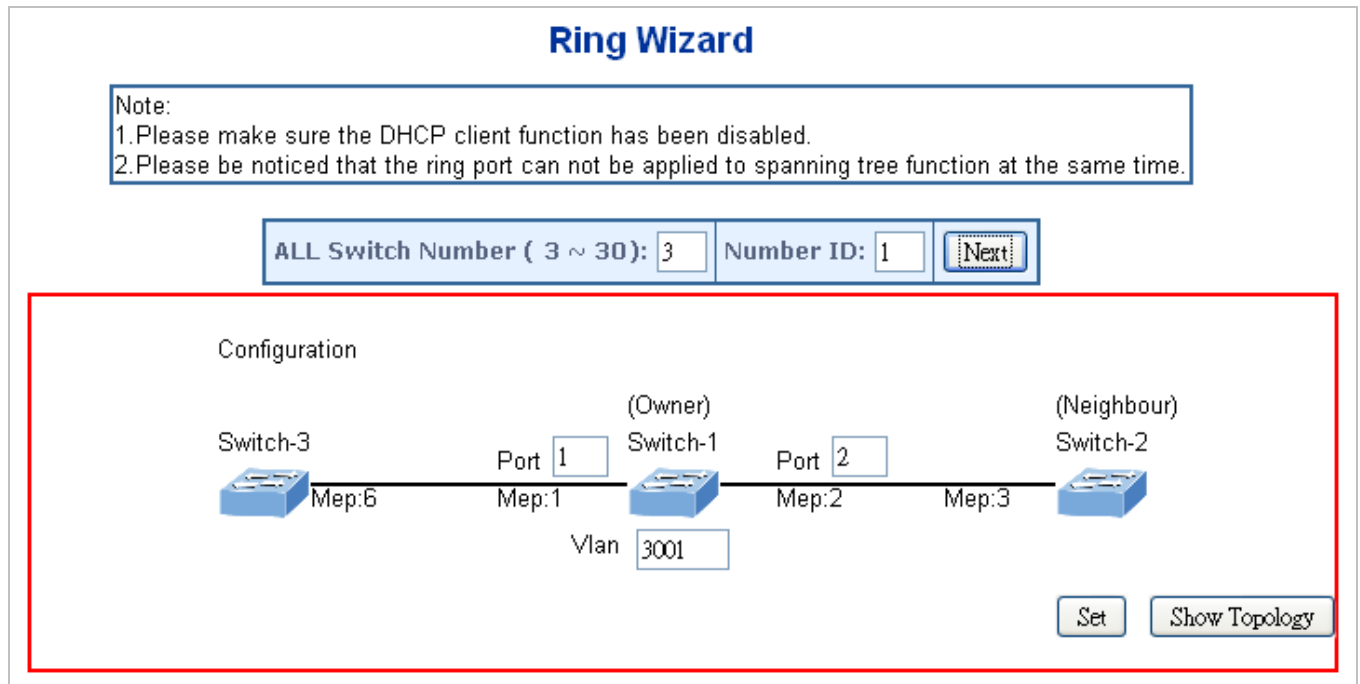

Figure 4-19-5: Ring Wizard page screenshot

The page includes the following fields:

Object	Description
<ul style="list-style-type: none"> • All Switch Numbers 	Set all the switch numbers for the ring group. The default number is 3 and maximum number is 30.
<ul style="list-style-type: none"> • Number ID 	The switch where you are requesting ERPS.
<ul style="list-style-type: none"> • Port 	Configures the port number for the MEP.
<ul style="list-style-type: none"> • VLAN 	Set the ERPS VLAN.

Buttons

: Click to configure ERPS.

: Click to save changes.

: Click to show the ring topology.

4.19.6 Ring Wizard Example:

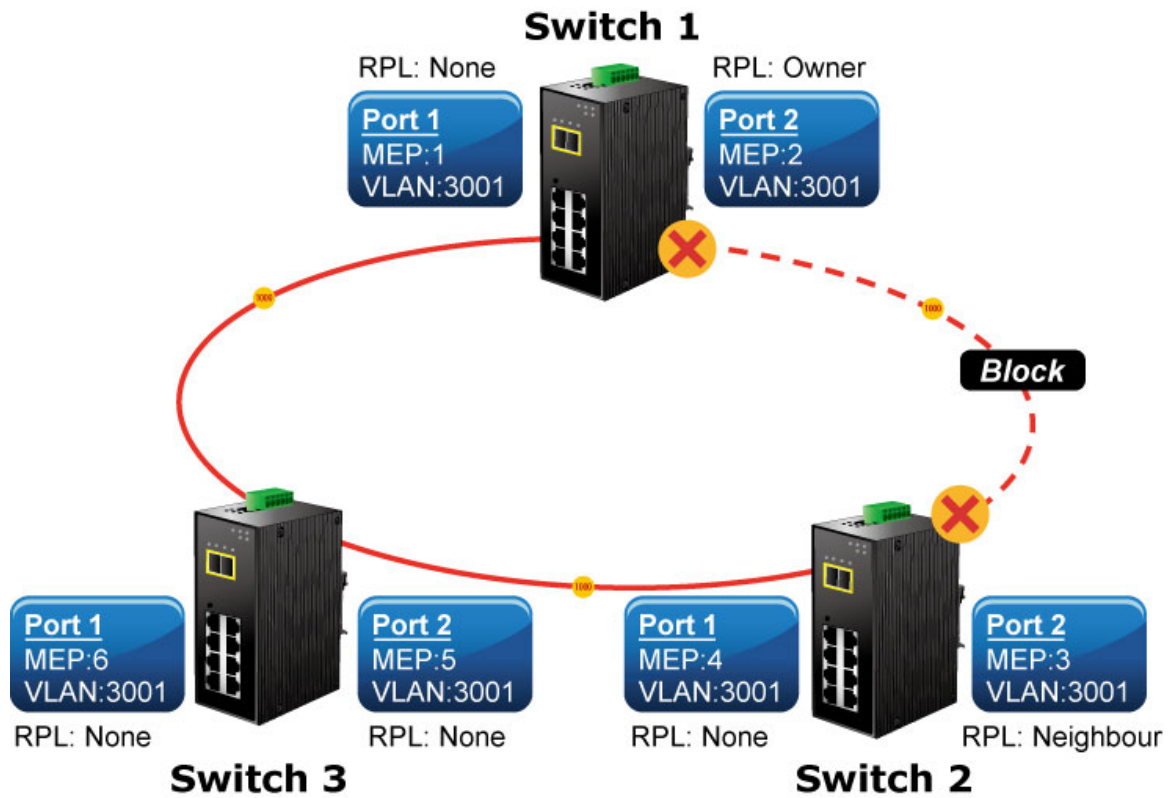

Figure 4-19-6: Ring Example Diagram

The above topology often occurs on using ERPS protocol. The multi switch constitutes a single ERPS ring; all of the switches only are configured as an ERPS in VLAN 3001, thereby constituting a single MRPP ring.

Switch ID	Port	MEP ID	RPL Type	VLAN Group
Switch 1	Port 1	1	None	3001
	Port 2	2	Owner	3001
Switch 2	Port 1	4	None	3001
	Port 2	3	Neighbour	3001
Switch 3	Port 1	6	None	3001
	Port 2	5	None	3001

Table 4-2: ERPS Configuration Table

The scenario described as follows:

1. Disable DHCP client and set proper static IP for Switch 1, 2 & 3. In this example, switch 1 is 192.168.0.101; switch 2 is 192.168.0.102 and switch 3 is 192.168.0.103.
2. On switch 1, 2 & 3, disable spanning tree protocol to avoid confliction with ERPS.

Setup steps

Set ERPS Configuration on Switch 1

Connect PC to switch 1 directly; don't connect to port 1 & 2

Logging on the Switch 1 and click "Ring > Ring Wizard"

Set "All Switch Number" = 3 and "Number ID" = 1; click "Next" button to set the ERPS configuration for Switch 1.

Set "MEP1" = Port1, "MEP2" = Port2 and VLAN ID = 3001; click "Set" button to save the ERPS configuration for Switch 1.

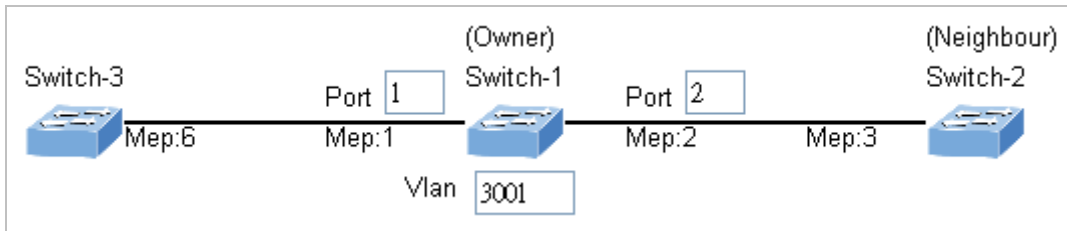

Set ERPS Configuration on Switch 2

Connect PC to switch 2 directly; don't connect to port 1 & 2

Logging on the Switch 2 and click "Ring > Ring Wizard"

Set "All Switch Number" = 3 and "Number ID" = 2; click "Next" button to set the ERPS configuration for Switch 2.

Set "MEP3" = Port2, "MEP4" = Port1 and VLAN ID = 3001; click "Set" button to save the ERPS configuration for Switch 2.

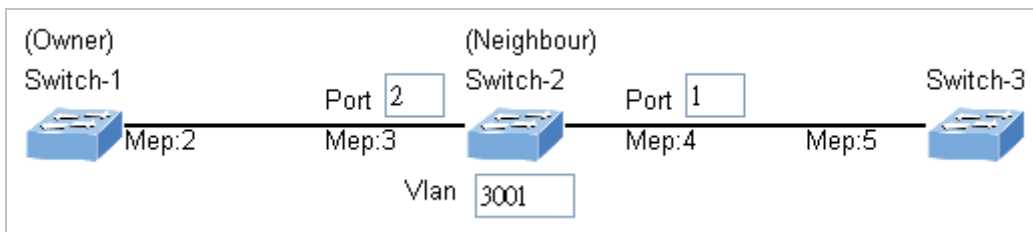

Set ERPS Configuration on Switch 3

Connect PC to switch 3 directly; don't connect to port 1 & 2

Logging on the Switch 3 and click "Ring > Ring Wizard"

Set "All Switch Number" = 3 and "Number ID" = 3; click "Next" button to set the ERPS configuration for Switch 3.

Set "MEP5" = Port2, "MEP6" = Port1 and VLAN ID = 3001; click "Set" button to save the ERPS configuration for Switch 3.

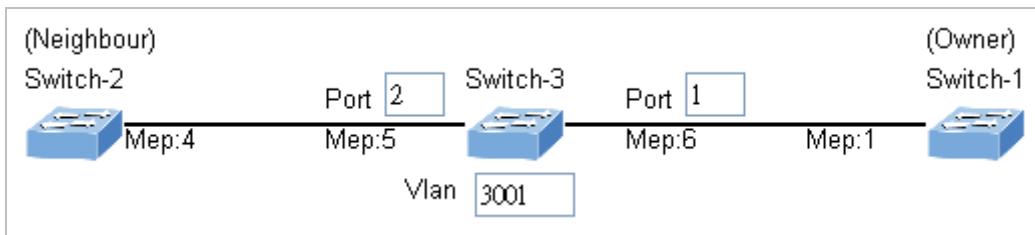

To avoid loop, please don't connect switch 1, 2 & 3 together in the ring topology before configuring the end of ERPS .

Follow the configuration or ERPS wizard to connect the Switch 1, 2 & 3 together to establish ERPS application:

MEP2 ↔ MEP3 = Switch1 / Port2 ↔ Switch2 / Port2

MEP4 ↔ MEP5 = Switch2 / Port1 ↔ Switch3 / Port2

MEP1 ↔ MEP6 = Switch1 / Port1 ↔ Switch3 / Port1

5. COMMAND LINE INTERFACE

5.1 Accessing the CLI

When accessing the management interface for the **Industrial Managed Switch** via a Telnet connection, the **Industrial Managed Switch** can be managed by entering command keywords and parameters at the prompt. Using the **Industrial Managed Switch's** command-line interface (CLI) is very similar to entering commands on a UNIX system.

This chapter describes how to use the Command Line Interface (CLI).

5.2 Telnet Login

The **Industrial Managed Switch** supports telnet for remote management. The **Industrial Managed Switch** asks for user name and password for login when using telnet, please use "admin" for username & password.

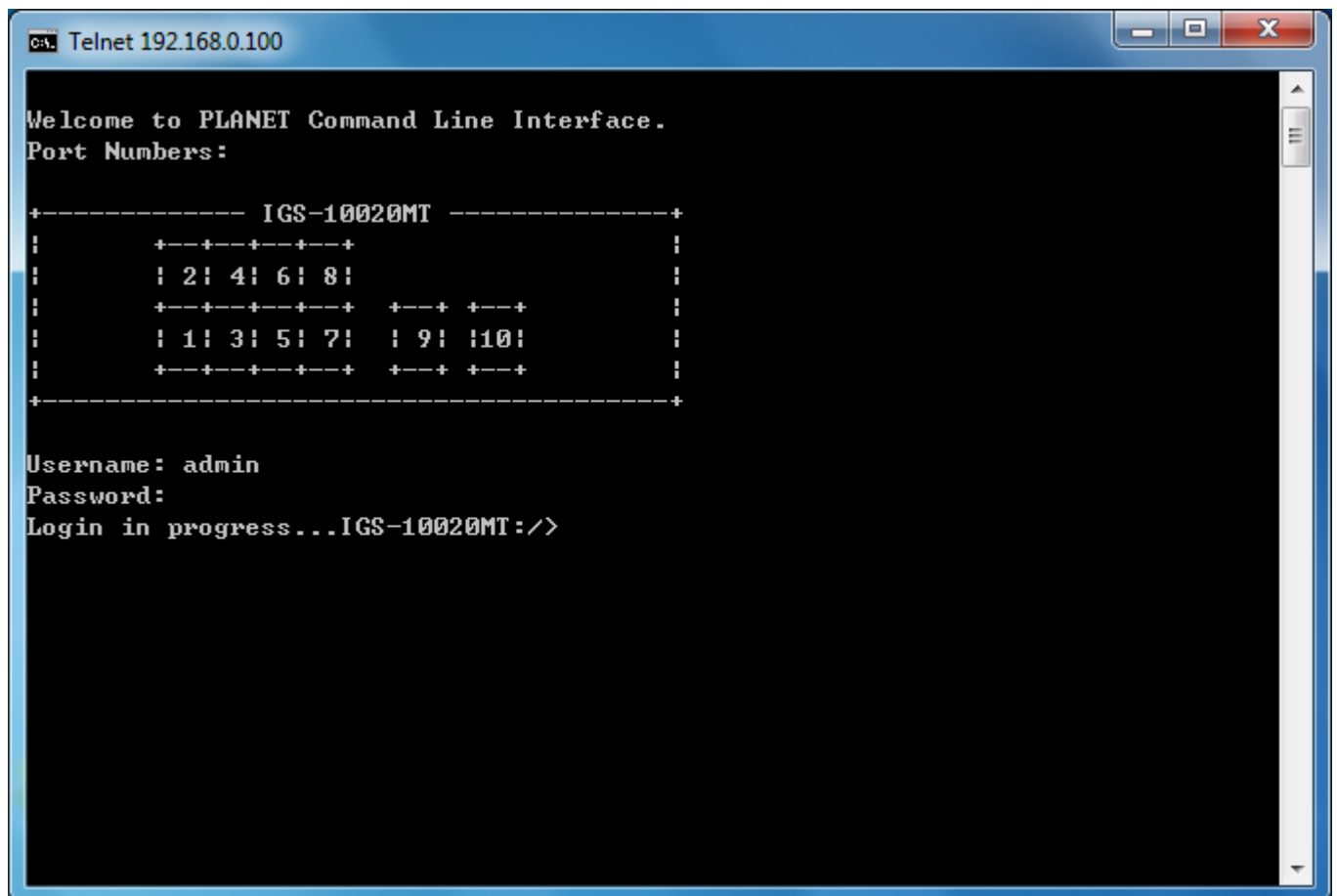

```
C:\> Telnet 192.168.0.100

Welcome to PLANET Command Line Interface.
Port Numbers:

+----- IGS-10020MT -----+
|  +---+---+---+---+         |
|  | 2| 4| 6| 8|         |
|  +---+---+---+---+   +---+ +---+ |
|  | 1| 3| 5| 7|   | 9| 10| |
|  +---+---+---+---+   +---+ +---+ |
+-----+

Username: admin
Password:
Login in progress...IGS-10020MT:/>
```

6. COMMAND LINE MODE

The CLI groups all the commands in appropriate modes according to the nature of the command. A sample of the CLI command modes are described below. Each of the command modes supports specific software commands.

Command Groups:

System	System settings and reset options
IP	IP configuration and Ping
Port	Port management
MAC	MAC address table
VLAN	Virtual LAN
PVLAN	Private VLAN
Security	Security management
STP	Spanning Tree Protocol
Aggr	Link Aggregation
LACP	Link Aggregation Control Protocol
LLDP	Link Layer Discovery Protocol
LLDPMED	Link Layer Discovery Protocol Media
EEE	Energy Efficient Ethernet
Thermal	Thermal Protection
QoS	Quality of Service
Mirror	Port mirroring
Config	Load/Save of configuration via TFTP
Firmware	Download of firmware via TFTP
UPnP	Universal Plug and Play
MVR	Multicast VLAN Registration
Voice VLAN	Specific VLAN for voice traffic
Loop Protect	Loop Protection
IPMC	MLD/IGMP Snooping
VCL	VLAN Control List
SMTP	SMTP Control Configure

6.1 System Command

System Configuration

Description:

Show system configuration.

Syntax:

System Configuration [all] [<port_list>]

Parameters:

all : Show all switch configuration, default: Show system configuration
port : Show switch port configuration
<port_list>: Port list or 'all', default: All ports

Example:

To display system information:

```
IGS-10020MT:/>System configuration
System Contact :
System Name : IGS-10020MT
System Location :
Timezone Offset : 0
MAC Address : 00-30-4F-00-a0-01
System Time : 1970-01-01 Thu 02:50:01+00:00
System Uptime : 00:10:55
Software Version: 1.0b120618
Software Date : 2012-06-18T10:43:11+0800
Previous Restart: Cold
IGS-10020MT:/>
```

System Log Configuration

Description:

Show system log configuration.

Syntax:

System Log Configuration

Example:

To display system log information:

```
IGS-10020MT:/>System log configuration
System Log Configuration:
=====
System Log Server Mode      : Disabled
System Log Server Address  :
System Log Level           : Info
IGS-10020MT:/>
```

System Version**Description:**

Show system version information.

Syntax:

System Version

Example:

To display system version:

```
IGS-10020MT:/>System version
Version      : 1.0b120618
Build Date   : 2012-06-18T10:43:11+0800
IGS-10020MT:/>
```

System Log Server Mode**Description:**

Show or set the system log server mode.

Syntax:

System Log Server Mode [enable|disable]

Parameters:

enable : Enable system log server mode

disable: Disable system log server mode

(default: Show system Log server mode)

Default Setting:

disable

Example:

To show the log server mode:

```
IGS-10020MT:/>System log server mode
System Log Server Mode      : Disabled
```

System Name**Description:**

Set or show the system name.

Syntax:

System Name [<name>] [clear]

Parameters:**<name>**: System name string. (1-255)

Use 'clear' or "" to clear the string

System name is a text string drawn from the alphabet (A-Za-z), digits (0-9), minus sign (-).

In CLI, no blank or space characters are permitted as part of a name.

The first character must be an alpha character, and the first or last character must not be a minus sign.

clear : Clear system name**Example:**

To set device title:

```
IGS-10020MT:/>System name      :IGS-10020MT
```

System Contact**Description:**

Set or show the system contact.

Syntax:

System Contact [<contact>] [clear]

Parameters:

<contact>: System contact string. (1-255)

Use 'clear' or "" to clear the string

In CLI, No blank or space characters are permitted as part of a contact.

clear : Clear system contact

Default Setting:

empty

Example:

To set device contact:

```
IGS-10020MT:/>System contact :
```

System Log Server Address**Description:**

Show or set the system log server address.

Syntax:

System Log Server Address [**<ip_addr_string>**]

Parameters:

<ip_addr_string>: IP host address (a.b.c.d) or a host name string

Default Setting:

empty

Example:

To set log server address:

```
IGS-10020MT:/> log server address 192.168.0.21
```

System Location**Description:**

Set or show the system location.

Syntax:

System Location [**<location>**] [clear]

Parameters:

<location>: System location string. (1-255)

Use 'clear' or "" to clear the string

In CLI, no blank or space characters are permitted as part of a location.

clear : Clear system location

Default Setting:

empty

Example:

To set device location:

```
IGS-10020MT:/>System location 9F-LAB
```

System Log Level

Description:

Show or set the system log level.

It uses to determine what kind of message will send to syslog server.

Syntax:

System Log Level [info|warning|error]

Parameters:

info : Send informations, warnings and errors

warning : Send warnings and errors

error : Send errors

Default Setting:

info

Example:

To set log level:

```
IGS-10020MT:/> log level warning
```

System Timezone

Description:

Set or show the system timezone offset.

Syntax:

System Timezone [<offset>]

Parameters:

<offset>: Time zone offset in minutes (-720 to 720) relative to UTC

Default Setting:

0

Example:

To set timezone:

```
IGS-10020MT:/>system timezone 0
```

System Log Lookup

Description:

Show or clear the system log.

Syntax:

System Log Lookup [<log_id>] [all|info|warning|error] [clear]

Parameters:

<log_id>: System log ID or range (default: All entries)

all : Show all levels (default)

info : Show informations

warning : Show warnings

error : Show errors

clear : Clear log

Example:

To show system log:

```
IGS-10020MT:/>system log lookup
Number of entries:
Info   : 2
Warning: 0
Error  : 0
All    : 2

ID      Level  Time                               Message
-----
  1  Info   -   Switch just made a cold boot.
  2  Info   1970-01-01T00:00:05+00:00  Link up on port 8
IGS-10020MT:/>
```

System Reboot**Description:**

Reboot the system.

Syntax:

System Reboot

Example:

To reboot device without changing any of the settings:

```
IGS-10020MT:/>system reboot
```

System Restore Default**Description:**

Restore factory default configuration.

Syntax:

System Restore Default [keep_ip]

Parameters:

keep_ip: Keep IP configuration, default: Restore full configuration

Example:

To restore default value but not reset IP address:

```
IGS-10020MT:/>system restore default keep_ip
```

System Load**Description:**

Show current CPU load: 100ms, 1s and 10s running average (in percent, zero is idle).

Syntax:

System Load

Example:

To show current CPU load:

```
IGS-10020MT:/>system load
Load average(100ms, 1s, 10s):  1%,  1%,  1%
```

6.2 IP Command**IP Configuration****Description:**

Show IP configuration.

Syntax:

IP Configuration

Example:

Show IP configuration:

```
IGS-10020MT:/>ip configuration

IP Configuration:
=====

DHCP Client      : Disabled
IP Address       : 192.168.0.101
IP Mask          : 255.255.255.0
IP Router        : 192.168.0.253
DNS Server       : 0.0.0.0
```

```

VLAN ID          : 1
DNS Proxy        : Disabled

IPv6 AUTOCONFIG mode : Disabled
IPv6 Link-Local Address: fe80::6082:cdb9:19ab:c0e2
IPv6 Address     : ::192.168.0.100
IPv6 Prefix     : 96
IPv6 Router     : ::

```

IP DHCP

Description:

Set or show the DHCP client mode.

Syntax:

IP DHCP [enable|disable]

Parameters:

enable : Enable or renew DHCP client

disable: Disable DHCP client

Default Setting:

Disable

Example:

Disable DHCP sever:

```
IGS-10020MT:/>ip dhcp disable
```

IP Setup

Description:

Set or show the IP setup.

Syntax:

IP Setup [<ip_addr>] [<ip_mask>] [<ip_router>] [<vid>]

Parameters:

<ip_addr> : IP address (a.b.c.d), default: Show IP address
<ip_mask> : IP subnet mask (a.b.c.d), default: Show IP mask
<ip_router>: IP router (a.b.c.d), default: Show IP router
<vid> : VLAN ID (1-4095), default: Show VLAN ID

Default Setting:

IP Address : 192.168.0.100
 IP Mask : 255.255.255.0
 IP Router : 192.168.0.1
 DNS Server : 0.0.0.0
 VLAN ID : 1

Example:

Set IP address:

```
IGS-10020MT:/>ip setup 192.168.0.100 255.255.255.0
```

IP Ping**Description:**

Ping IP address (ICMP echo).

Syntax:

IP Ping <ip_addr_string> [<ping_length>]

Parameters:

<ip_addr_string>: IP host address (a.b.c.d) or a host name string
<ping_length> : Ping data length (8-1400), excluding MAC, IP and ICMP headers

Example:

```
IGS-10020MT:/>ip ping 192.168.0.21
PING server 192.168.0.21
60 bytes from 192.168.0.21: icmp_seq=0, time=0ms
60 bytes from 192.168.0.21: icmp_seq=1, time=0ms
60 bytes from 192.168.0.21: icmp_seq=2, time=0ms
60 bytes from 192.168.0.21: icmp_seq=3, time=10ms
60 bytes from 192.168.0.21: icmp_seq=4, time=0ms
Sent 5 packets, received 5 OK, 0 bad
```

IP DNS

Description:

Set or show the DNS server address.

Syntax:

IP DNS [<ip_addr>]

Parameters:

<ip_addr>: IP address (a.b.c.d), default: Showdne IP address

Default Setting:

0.0.0.0

Example:

Set DNS IP address:

```
IGS-10020MT:/>ip dns 168.95.1.1
```

IP DNS Proxy

Description:

Set or show the IP DNS Proxy mode.

Syntax:

IP DNS_Proxy [enable|disable]

Parameters:

enable : Enable DNS Proxy

disable: Disable DNS Proxy

Default Setting:

disable

Example:

Enable DNS proxy function:

```
IGS-10020MT:/>ip dns_proxy enable
```

IPv6 AUTOCINFIG

Description:

Set or show the IPv6 AUTOCONFIG mode.

Syntax:

IP IPv6 AUTOCONFIG [enable|disable]

Parameters:

enable : Enable IPv6 AUTOCONFIG mode

disable: Disable IPv6 AUTOCONFIG mode

Default Setting:

disable

Example:

Enable IPv6 autoconfig function:

```
IGS-10020MT:/>ip ipv6 autoconfig enable
```

IPv6 Setup

Description:

Set or show the IPv6 setup.

Syntax:

IP IPv6 Setup [<ipv6_addr>] [<ipv6_prefix>] [<ipv6_router>]

Parameters:

<ipv6_addr> : IPv6 address is in 128-bit records represented as eight fields of up to four hexadecimal digits with a colon separates each field (:). For example, four hexadecimal digits with a colon separates each field (:). For example, 'fe80::215:c5ff:fe03:4dc7'. The symbol '::' is a special syntax that can be used as a shorthand way of representing multiple 16-bit groups of contiguous zeros; but it can only appear once. It also used a following legally IPv4 address. For example, '::192.1.2.34'.

<ipv6_prefix>: IPv6 subnet mask , default: Show IPv6 prefix

<ipv6_router>: IPv6 router , default: Show IPv6 router. IPv6 address is in 128-bit records represented as eight fields of up to four hexadecimal digits with a colon separates each field (:). For example, 'fe80::215:c5ff:fe03:4dc7'. The symbol '::' is a special syntax that can be used as a shorthand way of representing multiple 16-bit groups of contiguous zeros; but it can only appear once. It also used a following legally IPv4 address. For example, '::192.1.2.34'.

Default Setting:

IPv6 AUTOCONFIG mode : Disabled
 IPv6 Link-Local Address: fe80::6082:cdb9:19ab:c0e2
 IPv6 Address : ::192.168.0.100
 IPv6 Prefix : 96
 IPv6 Router : ::

Example:

Set IPv6 address:

```
IGS-10020MT:/>ip ipv6 setup 2001::0002 64 2100::0001
```

IPv6 Ping**Description:**

Ping IPv6 address (ICMPv6 echo).

Syntax:

IP IPv6 Ping6 <ipv6_addr> [<ping_length>]

Parameters:

<ipv6_addr> : IPv6 host address.

IPv6 address is in 128-bit records represented as eight fields of up to four hexadecimal digits with a colon separates each field (:). For example, four hexadecimal digits with a colon separates each field (:). For example, 'fe80::215:c5ff:fe03:4dc7'. The symbol '::' is a special syntax that can be used as a shorthand way of representing multiple 16-bit groups of contiguous zeros; but it can only appear once. It also used a following legally IPv4 address. For example, '::192.1.2.34'.

<ping_length>: Ping data length (8-1400), excluding MAC, IP and ICMP headers

Example:

```
IGS-10020MT:/>ip ipv6 ping 2001::0002
PING6 server 2001::2
68 bytes from 2001::2: icmp_seq=0, time=0ms
68 bytes from 2001::2: icmp_seq=1, time=0ms
68 bytes from 2001::2: icmp_seq=2, time=0ms
68 bytes from 2001::2: icmp_seq=3, time=0ms
68 bytes from 2001::2: icmp_seq=4, time=0ms
Sent 5 packets, received 5 OK, 0 bad
```

IP NTP Configuration

Description:

Show NTP configuration.

Syntax:

IP NTP Configuration

Default Setting:

IP NTP Configuration:

=====

NTP Mode : Disabled

Idx Server IP host address (a.b.c.d) or a host name string

--- -----

1	pool.ntp.org
2	europe.pool.ntp.org
3	north-america.pool.ntp.org
4	asia.pool.ntp.org
5	oceania.pool.ntp.org

IP NTP Mode

Description:

Set or show the NTP mode.

Syntax:

IP NTP Mode [enable|disable]

Parameters:

enable : Enable NTP mode

disable : Disable NTP mode

(default: Show NTP mode)

Default Setting:

disable

Example:

Enable NTP mode:

```
IGS-10020MT:/>ip ntp mode enable
```

IP NTP Server Add**Description:**

Add NTP server entry.

Syntax:

IP NTP Server Add <server_index> <ip_addr_string>

Parameters:

<server_index> : The server index (1-5)

<ip_addr_string>: IP host address (a.b.c.d) or a host name string

Example:

To add NTP server:

```
IGS-10020MT:/>ip ntp server add 1 60.249.136.151
```

IP NTP Server IPv6 Add**Description:**

Add NTP server IPv6 entry.

Syntax:

IP NTP Server Ipv6 Add <server_index> <server_ipv6>

Parameters:

<server_index>: The server index (1-5)

<server_ipv6> : IPv6 server address. IPv6 address is in 128-bit records represented as eight fields of up to four hexadecimal digits with a colon separates each field (:). For example, 'fe80::215:c5ff:fe03:4dc7'. The symbol '::' is a special syntax that can be used as a shorthand way of representing multiple 16-bit groups of contiguous zeros; but it can only appear once. It also used a following legally IPv4 address. For example, ':::192.1.2.34'.

Example:

To add IPv6 NTP server:

```
IGS-10020MT:/>ip ntp server ipv6 add 1 2001:7b8:3:2c::123
```

IP NTP Server Delete

Description:

Delete NTP server entry.

Syntax:

IP NTP Server Delete <server_index>

Parameters:

<server_index>: The server index (1-5)

Example:

To delete NTP server:

```
IGS-10020MT:/>ip ntp server delete 1
```

6.3 Port Management Command

Port Configuration

Description:

Show port configuration.

Syntax:

Port Configuration [<port_list>] [up|down]

Parameters:

<port_list>: Port list or 'all', default: All ports

up : Show ports, which are up

down : Show ports, which are down

(default: Show all ports)

Example:

Display port1~4 status

```
IGS-10020MT:/>port configuration 1-4

Port Configuration:
=====

Port  State      Mode   Flow Control  MaxFrame  Power   Excessive  Link
-----  -
1     Enabled   Auto   Disabled      9600      Disabled Discard    Down
2     Enabled   Auto   Disabled      9600      Disabled Discard    Down
3     Enabled   Auto   Disabled      9600      Disabled Discard    Down
4     Enabled   Auto   Disabled      9600      Disabled Discard    Down
```

Port Mode

Description:

Set or show the port speed and duplex mode.

Syntax:

Port Mode [<port_list>] [auto|10hdx|10fdx|100hdx|100fdx|1000fdx]

Parameters:

<port_list>: Port list or 'all', default: All ports
auto : Auto negotiation of speed and duplex
10hdx : 10 Mbps, half duplex
10fdx : 10 Mbps, full duplex
100hdx : 100 Mbps, half duplex
100fdx : 100 Mbps, full duplex
1000fdx : 1 Gbps, full duplex
 (default: Show configured and current mode)

Default Setting:

Auto

Example:

Set 10Mbps (half duplex) speed for port1

```
IGS-10020MT:/>port mode 1 10hdx
```

Port Flow Control**Description:**

Set or show the port flow control mode.

Syntax:

Port Flow Control [<port_list>] [enable|disable]

Parameters:

<port_list>: Port list or 'all', default: All ports
enable : Enable flow control
disable : Disable flow control
 (default: Show flow control mode)

Default Setting:

Disable

Example:

Enable flow control function for port1

```
IGS-10020MT:/>port flow control 1 enable
```

Port State

Description:

Set or show the port administrative state.

Syntax:

Port State [<port_list>] [enable|disable]

Parameters:

<port_list>: Port list or 'all', default: All ports

enable : Enable port

disable : Disable port

(default: Show administrative mode)

Default Setting:

Enable

Example:

Disable port1

```
IGS-10020MT:/>port state 1 disable
```

Port Maximum Frame

Description:

Set or show the port maximum frame size.

Syntax:

Port MaxFrame [<port_list>] [<max_frame>]

Parameters:

<port_list>: Port list or 'all', default: All ports

<max_frame>: Port maximum frame size (1518-9600), default: Show maximum frame size

Default Setting:

9600

Example:

Set 2048 frame size for port1

```
IGS-10020MT:/>port maxframe 1 2048
```

Port Power

Description:

Set or show the port PHY power mode.

Syntax:

Port Power [<port_list>] [enable|disable|actiphy|dynamic]

Parameters:

<port_list>: Port list or 'all', default: All ports

enable : Enable all power control

disable: Disable all power control

actiphy: Enable ActiPHY power control

dynamic: Enable Dynamic power control

Default Setting:

disable

Example:

Disable port power function for port1-4

```
IGS-10020MT:/>port power 1-4 enable
```

Port Excessive

Description:

Set or show the port excessive collision mode.

Syntax:

Port Excessive [<port_list>] [discard|restart]

Parameters:

<port_list>: Port list or 'all', default: All ports

discard : Discard frame after 16 collisions

restart : Restart backoff algorithm after 16 collisions

(default: Show mode)

Default Setting:

Discard

Example:

```
IGS-10020MT:/>port excessive 1 restart
```

Port Statistics**Description:**

Show port statistics.

Syntax:

Port Statistics [<port_list>] [<command>] [up|down]

Parameters:

<port_list>: Port list or 'all', default: All ports

<command> : The command parameter takes the following values:

clear : Clear port statistics

packets : Show packet statistics

bytes : Show byte statistics

errors : Show error statistics

discards : Show discard statistics

filtered : Show filtered statistics

0..7 : Show priority statistics

(default: Show all port statistics)

up : Show ports, which are up

down : Show ports, which are down

(default: Show all ports)

Port VeriPHY**Description:**

Run cable diagnostics.

Syntax:

Port VeriPHY [<port_list>]

Parameters:

<port_list>: Port list or 'all', default: All ports

Port SFP**Description:**

Show SFP port information.

Syntax:

Port SFP [<port_list>]

Parameters:

<port_list>: Port list or 'all', default: All ports

Example:

Show SFP information for port21-24

```
IGS-10020MT:/>port sfp
```

Port	Type	Speed	Wave Length(nm)	Distance(m)
9	1000Base-LX	1000-Base	1310	10000
10	1000Base-LX	1000-Base	1310	10000

6.4 MAC Address Table Command

MAC Configuration

Description:

Show MAC address table configuration.

Syntax:

MAC Configuration [<port_list>]

Parameters:

<port_list>: Port list or 'all', default: All ports

Example:

Show Mac address state

```
IGS-10020MT:/>mac configuration
```

```
MAC Configuration:
```

```
=====
```

```
MAC Address      : 00-30-4f-24-04-d1
```

```
MAC Age Time: 300
```

```
Port  Learning
```

```
----  -
```

```
1    Auto
2    Auto
3    Auto
4    Auto
5    Auto
6    Auto
7    Auto
8    Auto
9    Auto
10   Auto
```

MAC Add

Description:

Add MAC address table entry.

Syntax:

MAC Add <mac_addr> <port_list> [<vid>]

Parameters:

<mac_addr> : MAC address (xx-xx-xx-xx-xx-xx)

<port_list>: Port list or 'all' or 'none'

<vid> : VLAN ID (1-4095), default: 1

Example:

Add Mac address 00-30-4F-01-01-02 in port1 and vid1

```
IGS-10020MT:/>mac add 00-30-4f-01-01-02 1 1
```

MAC Delete

Description:

Delete MAC address entry.

Syntax:

MAC Delete <mac_addr> [<vid>]

Parameters:

<mac_addr>: MAC address (xx-xx-xx-xx-xx-xx)

<vid> : VLAN ID (1-4095), default: 1

Example:

Delete Mac address 00-30-4F-01-01-02 in vid1

```
IGS-10020MT:/>mac delete 00-30-4f-01-01-02 1
```

MAC Lookup

Description:

Lookup MAC address entry.

Syntax:

MAC Lookup <mac_addr> [<vid>]

Parameters:

<mac_addr>: MAC address (xx-xx-xx-xx-xx-xx)

<vid> : VLAN ID (1-4095), default: 1

Example:

Lookup state of Mac address 00-30-4F-01-01-02

```
IGS-10020MT:/>mac lookup 00-30-4f-01-01-02
```

MAC Age Time**Description:**

Set or show the MAC address age timer.

Syntax:

MAC Agetime [<age_time>]

Parameters:

<age_time>: MAC address age time (0,10-1000000) 0=disable,
(default: Show age time)

Default Setting:

300

Example:

Set agetime value in 30

```
IGS-10020MT:/>mac agetime 30
```

MAC Learning**Description:**

Set or show the port learn mode.

Syntax:

MAC Learning [<port_list>] [auto|disable|secure]

Parameters:

<port_list>: Port list or 'all', default: All ports

auto : Automatic learning

disable: Disable learning

secure : Secure learning

(default: Show learn mode)

Default Setting:

Auto

Example:

Set secure learning mode in port1

```
IGS-10020MT:/>mac learning 1 secure
```

MAC Dump

Description:

Show sorted list of MAC address entries.

Syntax:

MAC Dump [<mac_max>] [<mac_addr>] [<vid>]

Parameters:

<mac_max> : Maximum number of MAC addresses 1-8192, default: Show all addresses

<mac_addr>: First MAC address (xx-xx-xx-xx-xx-xx), default: MAC address zero

<vid> : First VLAN ID (1-4095), default: 1

Example:

Show all of MAC table

```
IGS-10020MT:/>mac dump
```

Type	VID	MAC Address	Ports
-----	---	-----	----
Static	1	00-30-00-33-22-55	1
Static	1	00-30-4f-24-04-d1	None,CPU
Static	1	33-33-ff-24-04-d1	None,CPU
Static	1	33-33-ff-a8-00-64	None,CPU
Dynamic	1	40-61-86-04-18-69	10
Static	1	ff-ff-ff-ff-ff-ff	1-24,CPU

MAC Statistics

Description:

Show MAC address table statistics.

Syntax:

MAC Statistics [<port_list>]

Parameters:

<port_list>: Port list or 'all',
(default: All ports)

Example:

Set all of MAC statistics

```
IGS-10020MT:/>mac statistics
Port  Dynamic Addresses
-----
1     0
2     0
3     0
4     0
5     0
6     0
7     0
8     0
9     0
10    0

Total Dynamic Addresses: 0
Total Static Addresses : 4
```

MAC Flush**Description:**

Flush all learned entries.

Syntax:

MAC Flush

6.5 VLAN Configuration Command

VLAN Configuration

Description:

Show VLAN configuration.

Syntax:

VLAN Configuration [<port_list>]

Parameters:

<port_list>: Port list or 'all',
(default: All ports)

Example:

Show VLAN status of port1

```
IGS-10020MT:/>vlan configuration 1

VLAN Configuration:
=====

Mode : IEEE 802.1Q
Port  PVID  IngrFilter  FrameType  LinkType  Q-in-Q Mode  Eth type
-----
1     1     Disabled    All         UnTag     Disable      N/A

VID   VLAN Name                Ports
-----
1     default                  1-10

VID   VLAN Name                Ports
-----

VLAN forbidden table is empty
```

VLAN PVID

Description:

Set or show the port VLAN ID.

Syntax:

VLAN PVID [<port_list>] [<vid>|none]

Parameters:

<port_list>: Port list or 'all', default: All ports

<vid>|none : Port VLAN ID (1-4095) or 'none',
(default: Show port VLAN ID)

Default Setting:

1

Example:

Set PVID2 for port10

```
IGS-10020MT:/>vlan pvid 10 2
```

VLAN Frame Type**Description:**

Set or show the port VLAN frame type.

Syntax:

VLAN FrameType [<port_list>] [all|tagged]

Parameters:

<port_list>: Port list or 'all', default: All ports

all : Allow tagged and untagged frames

tagged : Allow tagged frames only

(default: Show accepted frame types)

Default Setting:

All

Example:

Set port10 that allow tagged frames only

```
IGS-10020MT:/>vlan frametype 10 tagged
```

VLAN Ingress Filter

Description:

Set or show the port VLAN ingress filter.

Syntax:

VLAN IngressFilter [<port_list>] [enable|disable]

Parameters:

<port_list>: Port list or 'all', default: All ports

enable : Enable VLAN ingress filtering

disable : Disable VLAN ingress filtering

(default: Show VLAN ingress filtering)

Default Setting:

Disable

Example:

Enable VLAN ingress filtering for port10

```
IGS-10020MT:/>vlan ingressfilter 10 enable
```

VLAN Mode

Description:

Set or show the VLAN Mode.

Syntax:

VLAN Mode [portbased|dot1q]

Parameters:

portbased : Port-Based VLAN Mode

dot1q : 802.1Q VLAN Mode

(default: Show VLAN Mode)

Default Setting:

IEEE 802.1Q

Example:

Set VLAN mode in port base

```
IGS-10020MT:/>vlan mode portbased
```

VLAN Link Type**Description:**

Set or show the port VLAN link type.

Syntax:

VLAN LinkType [<port_list>] [untagged|tagged]

Parameters:

<port_list>: Port list or 'all', default: All ports

untagged : VLAN Link Type Tagged

tagged : VLAN Link Type Untagged

(default: Show VLAN link type)

Default Setting:

Un-tagged

Example:

Enable tagged frame for port2

```
IGS-10020MT:/>vlan linktype 2 tagged
```

VLAN Q-in-Q Mode**Description:**

Set or show the port Q-in-Q mode.

Syntax:

VLAN QinQ [<port_list>] [disable|man|customer]

Parameters:

<port_list>: Port list or 'all', default: All ports

disable : Disable Q-in-Q VLAN Mode

man : Q-in-Q MAN Port Mode

customer : Q-in-Q Customer Port Mode

(default: Show VLAN QinQ Mode)

Example:

Set port2 in man port

```
IGS-10020MT:/>vlan qinq 2 man
```

VLAN Ethernet Type**Description:**

Set or show out layer VLAN tag ether type in Q-in-Q VLAN mode.

Syntax:

VLAN Ethtype [<port_list>] [man|dot1q]

Parameters:

<port_list>: Port list or 'all', default: All ports

man : Set out layer VLAN tag ether type : MAN

dot1q : Set out layer VLAN tag ether type : 802.1Q

(default: Show VLAN out layer VLAN tag ether type)

Default Setting:

N/A

Example:

Set out layer VLAN tag Ethernet type for port 10 in man Ethernet type

```
IGS-10020MT:/>vlan ethtype 10 man
```

VLAN Add**Description:**

Add or modify VLAN entry.

Syntax:

VLAN Add <vid>|<name> [<port_list>]

Parameters:

<vid>|<name>: VLAN ID (1-4095) or VLAN Name

<port_list> : Port list or 'all', default: All ports

Default Setting:

1

Example:

Add port1 to port4 in VLAN10

```
IGS-10020MT:/>vlan add 10 1-4
```

VLAN Forbidden Add

Description:

Add or modify VLAN entry in forbidden table.

Syntax:

VLAN Forbidden Add <vid>|<name> [<port_list>]

Parameters:

<vid>|<name>: VLAN ID (1-4095) or VLAN Name

<port_list> : Port list or 'all', default: All ports

Example:

Forbidden add port1 to port4 in VLAN10

```
IGS-10020MT:/>vlan forbidden add 10 1-4
```

VLAN Delete

Description:

Delete VLAN entry.

Syntax:

VLAN Delete <vid>|<name>

Parameters:

<vid>|<name>: VLAN ID (1-4095) or VLAN Name

Example:

Delete VLAN10

```
IGS-10020MT:/>vlan delete 10
```

VLAN Forbidden Delete

Description:

Delete VLAN entry.

Syntax:

LAN Forbidden Delete <vid>|<name>

Parameters:

<vid>|<name>: VLAN ID (1-4095) or VLAN Name

Example:

Forbidden delete VLAN10

```
IGS-10020MT:/>vlan forbidden delete 10
```

VLAN Forbidden Lookup

Description:

Lookup VLAN Forbidden port entry.

Syntax:

VLAN Forbidden Lookup [<vid>] [(name <name>)]

Parameters:

<vid> : VLAN ID (1-4095), default: Show all VLANs

name : VLAN name string

<name>: VLAN name - Maximum of 32 characters. VLAN Name can only contain alphabets or numbers.

VLAN name should contain atleast one alphabet.

VLAN Lookup

Description:

Lookup VLAN entry.

Syntax:

VLAN Lookup [<vid>] [(name <name>)] [combined|static|nas|mvr|voice_vlan|all]

Parameters:

<vid> : VLAN ID (1-4095), default: Show all VLANs

name : VLAN name string

<name>: VLAN name - Maximum of 32 characters. VLAN Name can only contain alphabets or numbers.

VLAN name should contain atleast one alphabet.

combined : Shows All the Combined VLAN database

static : Shows the VLAN entries configured by the administrator

nas : Shows the VLANs configured by NAS

mvr : Shows the VLANs configured by MVR

voice_vlan : Shows the VLANs configured by Voice VLAN

all : Shows all VLANs configuration

(default: combined VLAN Users configuration)

Example:

Show VLAN status

```
IGS-10020MT:/>vlan lookup
```

VID	VLAN Name	Ports
1	default	1-10

VLAN Name Add

Description:

Add VLAN Name to a VLAN ID Mapping.

Syntax:

VLAN Name Add <name> <vid>

Parameters:

<name>: VLAN name - Maximum of 32 characters. VLAN Name can only contain alphabets or numbers.

VLAN name should contain atleast one alphabet.

<vid> : VLAN ID (1-4095)

Example:

Add VLAN name for VLAN 1

```
IGS-10020MT:/>vlan name add test 1
```

VLAN Name Delete

Description:

Delete VLAN Name to VLAN ID Mapping.

Syntax:

VLAN Name Delete <name>

Parameters:

<name>: VLAN name - Maximum of 32 characters. VLAN Name can only contain alphabets or numbers.

VLAN name should contain atleast one alphabet.

Example:

Delete VLAN name

```
IGS-10020MT:/>vlan name delete test
```

VLAN Name Lookup

Description:

Show VLAN Name table.

Syntax:

VLAN Name Lookup [<name>]

Parameters:

<name>: VLAN name - Maximum of 32 characters. VLAN Name can only contain alphabets or numbers.

VLAN name should contain atleast one alphabet.

Example:

To show VLAN Name table

```
IGS-10020MT:/>vlan name lookup
VLAN NAME          vid
-----
test                1
```

VLAN Status

Description:

VLAN Port Configuration Status.

Syntax:

VLAN Status [<port_list>] [combined|static|nas|mvr|voice_vlan|mstp|all|conflicts]

Parameters:

- <port_list>**: Port list or 'all', default: All ports
 - combined** : combined VLAN Users configuration
 - static** : static port configuration
 - nas** : NAS port configuration
 - mvr** : MVR port configuration
 - voice_vlan** : Voice VLAN port configuration
 - mstp** : MSTP port configuration
 - all** : All VLAN Users configuration
- (default: combined VLAN Users configuration)

Default Setting:

Promiscuous

Example:

Show VLAN configuration of port10

```
IGS-10020MT:/>status 1

Port  VLAN User  PortType  PVID  Frame Type  Ing Filter  Tx Tag  UVID
Conflicts
-----
```

1	Static	Unaware	1	All	Disabled	Untag This	1
	NAS						
No							
	MVR						
No							
	Voice VLAN						
No							
	MSTP						
No							
	Combined	Unaware	1	All	Disabled	Untag This	1
No							

6.6 Private VLAN Configuration Command

PVLAN Configuration

Description:

Show Private VLAN configuration.

Syntax:

PVLAN Configuration [<port_list>]

Parameters:

<port_list>: Port list or 'all', default: All ports

Example:

Show private VLAN configuration

```
IGS-10020MT:/> pvlan configuration

Private VLAN Configuration:
=====

Port  Isolation
----  -
1     Disabled
2     Disabled
3     Disabled
4     Disabled
5     Disabled
```

6	Disabled
7	Disabled
8	Disabled
9	Disabled
10	Disabled
PVLAN ID	Ports
-----	-----
1	1-10

PVLAN Add

Description:

Add or modify Private VLAN entry.

Syntax:

PVLAN Add <pvlan_id> [<port_list>]

Parameters:

<pvlan_id> : Private VLAN ID. The allowed range for a Private VLAN ID is the same as the switch port number range.

<port_list>: Port list or 'all', default: All ports

Example:

Add port1 to port4 in PVLAN10

```
IGS-10020MT:/>pvlan add 10 1-4
```

PVLAN Delete

Description:

Delete Private VLAN entry.

Syntax:

PVLAN Delete <pvlan_id>

Parameters:

<pvlan_id>: Private VLAN ID. The allowed range for a Private VLAN ID is the same as the switch port number range.

Example:

Delete PVLAN10

```
IGS-10020MT:/>pvlan delete 10
```

PVLAN Lookup**Description:**

Lookup Private VLAN entry.

Syntax:

PVLAN Lookup [<pvlan_id>]

Parameters:

<pvlan_id>: Private VLAN ID, default: Show all PVLANs. The allowed range for a Private VLAN ID is the same as the switch port number range.

Example:

Lookup PVLAN

```
IGS-10020MT:/>pvlan lookup
```

PVLAN ID	Ports
1	1-10

PVLAN Isolate**Description:**

Set or show the port isolation mode.

Syntax:

PVLAN Isolate [<port_list>] [enable|disable]

Parameters:

<port_list>: Port list or 'all', default: All ports

enable : Enable port isolation

disable : Disable port isolation

(default: Show port isolation port list)

Default Setting:

disable

Example:

Enable isolate for port10

```
IGS-10020MT:/>pvlan isolate 10 enable
```

6.7 Security Command

Security Switch User Configuration

Description:

Show users configuration.

Syntax:

Security Switch Users Configuration

Default Setting:

User Name	Privilege
admin	15

Example:

Show users configuration

```
IGS-10020MT:/>security switch user configuration
```

Users Configuration:

```
=====
```

```
User Name                Privilege Level
-----                -
admin                    15
```

Security Switch User Add

Description:

Add or modify users entry.

Syntax:

Security Switch Users Add <user_name> <password> <privilege_level>

Parameters:

- <user_name>** : A string identifying the user name that this entry should belong to. The allowed string length is (1-32). The valid user name is a combination of letters, numbers and underscores
- <password>** : The password for this user name. The allowed string length is (0-32). Use 'clear' or "" as null string
- <privilege_level>**: User privilege level (1-15)

Example:

Add new user: username: test, password: test & privilege: 10

```
IGS-10020MT:/>security switch users add test test 10
```

Security Switch User Delete

Description:

Delete users entry.

Syntax:

Security Switch Users Delete <user_name>

Parameters:

- <user_name>**: A string identifying the user name that this entry should belong to. The allowed string length is (1-32). The valid user name is a combination of letters, numbers and underscores

Example:

Delete test account.

```
IGS-10020MT:/>security switch users delete user
```

Security Switch Privilege Level Configuration

Description:

Show privilege configuration.

Syntax:

Security Switch Privilege Level Configuration

Example:

Show privilege level

```
IGS-10020MT:/>security switch privilege level configuration

Privilege Level Configuration:
=====

Privilege Current Level: 15

Group Name                Privilege Level
                          CRO CRW SRO SRW
-----
Aggregation                5  10  5  10
Debug                      15 15 15 15
Diagnostics                5  10  5  10
DualCPU                    5  10  5  10
EEE                        5  10  5  10
IP                          5  10  5  10
LACP                       5  10  5  10
LLDP                       5  10  5  10
LLDP_MED                   5  10  5  10
MAC_Table                  5  10  5  10
MVR                        5  10  5  10
Maintenance                15 15 15 15
Mirroring                  5  10  5  10
Multicast                  5  10  5  10
Port_Security              5  10  5  10
Ports                      5  10  1  10
Private_VLANs              5  10  5  10
Protocol_based_VLAN        5  10  5  10
QoS                        5  10  5  10
SNMP                       5  10  5  10
Security                   5  10  5  10
Spanning_Tree              5  10  5  10
System                     5  10  1  10
UPnP                       5  10  5  10
VLANs                      5  10  5  10
Voice_VLAN                 5  10  5  10
```

Security Switch Privilege Level Group

Description:

Configure a privilege level group.

Syntax:

Security Switch Privilege Level Group <group_name> [<cro>] [<crw>] [<sro>] [<srw>]

Parameters:

<group_name>: Privilege group name

<cro> : Configuration read-only privilege level (1-15)

<crw> : Configuration/Execute read-write privilege level (1-15)

<sro> : Status/Statistics read-only privilege level (1-15)

<srw> : Status/Statistics read-write privilege level (1-15)

Example:

Change privilege level of MVR group.

```
IGS-10020MT:/>security switch privilege level group mvr 15 15 15 15
```

Security Switch Privilege Level Current

Description:

Show the current privilege level.

Syntax:

Security Switch Privilege Level Current

Default Setting:

15

Security Switch Auth Configuration

Description:

Show Auth configuration.

Syntax:

Security Switch Auth Configuration

Example:

Show authentication configuration.

```
IGS-10020MT:/>security switch auth configuration

Auth Configuration:
=====

Client      Authentication Method  Local Authentication Fallback
-----
console    local                  Disabled
telnet     local                  Disabled
ssh        local                  Disabled
web        local                  Disabled
```

Security Switch Auth Method**Description:**

Set or show Auth method. (default: Show Auth method).

Syntax:

Security Switch Auth Method [console|telnet|ssh|web] [none|local|radius|tacacs+] [enable|disable]

Parameters:

console : Settings for console

telnet : Settings for telnet

ssh : Settings for ssh

web : Settings for web

(default: Set or show the specific client authentication method)

none : Authentication disabled

local : Use local authentication

radius : Use remote RADIUS authentication

tacacs+ : Use remote TACACS+ authentication

(default: Show client authentication method)

enable : Enable local authentication if remote authentication fails

disable : Disable local authentication if remote authentication fails

(The parameter is effective when it is typed)

Default Setting:

disable

Example:

Use RADIUS authentication method for telnet.

```
IGS-10020MT:/>security switch auth method telnet radius enable
```

Security Switch SSH Configuration

Description:

Show SSH configuration.

Syntax:

Security Switch SSH Configuration

Example:

Show SSH configuration.

```
IGS-10020MT:/>security switch ssh configuration
```

```
SSH Configuration:
```

```
=====
```

```
SSH Mode : Enable
```

Security Switch SSH Mode

Description:

Set or show the SSH mode.

Syntax:

Security Switch SSH Mode [enable|disable]

Parameters:

enable : Enable SSH

disable: Disable SSH

(default: Show SSH mode)

Default Setting:

enable

Example:

Enable SSH function.

```
IGS-10020MT:/>security switch ssh mode enable
```

Security Switch HTTPS Configuration**Description:**

Show HTTPS configuration.

Syntax:

Security Switch HTTPS Configuration

Example:

Show HTTPS configuration.

```
IGS-10020MT:/>security switch https configuration
```

```
HTTPS Configuration:
```

```
=====
```

```
HTTPS Mode           : Enable
```

```
HTTPS Redirect Mode : Disabled
```

Security Switch HTTPS Mode**Description:**

Set or show the HTTPS mode.

Syntax:

Security Switch HTTPS Mode [enable|disable]

Parameters:

enable : Enable HTTPS

disable: Disable HTTPS

(default: Show HTTPS mode)

Default Setting:

enable

Example:

Enable HTTPs function.

```
IGS-10020MT:/>security switch https mode enable
```

Security Switch HTTPs Redirect

Description:

Set or show the HTTPs redirect mode.

Automatic redirect web browser to HTTPs during HTTPs mode enabled.

Syntax:

Security Switch HTTPs Redirect [enable|disable]

Parameters:

enable : Enable HTTPs redirect

disable: Disable HTTPs redirect

(default: Show HTTPs redirect mode)

Default Setting:

disable

Example:

Enable HTTPs redirect function.

```
IGS-10020MT:/>security switch https redirect enable
```

Security Switch Access Configuration

Description:

Show access management configuration.

Syntax:

Security Switch Access Configuration

Example:

Show access management configuration.

```
IGS-10020MT:/>security switch access configuration
```

```

Access Mgmt Configuration:
=====

System Access Mode : Disabled
System Access number of entries: 0
    
```

Security Switch Access Mode

Description:

Set or show the access management mode.

Syntax:

Security Switch Access Mode [enable|disable]

Parameters:

enable : Enable access management

disable: Disable access management

(default: Show access management mode)

Default Setting:

disable

Example:

Enable access management function.

```
IGS-10020MT:/>security switch access mode enable
```

Security Switch Access Configuration

Description:

Show access management configuration.

Syntax:

Security Switch Access Configuration

Example:

Show access management configuration.

```
IGS-10020MT:/>security switch access configuration
```

Access Mgmt Configuration:		
=====		
System Access Mode : Disabled		
W: WEB/HTTPS		
S: SNMP		
T: TELNET/SSH		
Idx	Start IP Address	End IP Address

		W S T

Security Switch Access Mode

Description:

Set or show the access management mode.

Syntax:

Security Switch Access Mode [enable|disable]

Parameters:

enable : Enable access management

disable: Disable access management

(default: Show access management mode)

Default Setting:

disable

Example:

Enable switch access mode

```
IGS-10020MT:/>security switch access mode enable
```

Security Switch Access Add

Description:

Add access management entry, default: Add all supported protocols.

Syntax:

Security Switch Access Add <access_id> <start_ip_addr> <end_ip_addr> [web] [snmp] [telnet]

Parameters:

- <access_id>** : entry index (1-16)
- <start_ip_addr>**: Start IP address (a.b.c.d)
- <end_ip_addr>** : End IP address (a.b.c.d)
- web** : Indicates that the host can access the switch from HTTP/HTTPS
- snmp** : Indicates that the host can access the switch from SNMP
- telnet** : Indicates that the host can access the switch from TELNET/SSH

Example:

Add access management list from 192.168.0.1 to 192.168.0.200 via web interface.

```
IGS-10020MT:/>security switch access add 1 192.168.0.1 192.168.0.200 web
```

Security Switch Access IPv6 Add**Description:**

Add access management IPv6 entry, default: Add all supported protocols.

Syntax:

Security Switch Access Ipv6 Add <access_id> <start_ipv6_addr> <end_ipv6_addr> [web] [snmp] [telnet]

Parameters:

- <access_id>** : entry index (1-16)
- <start_ipv6_addr>**: Start IPv6 address.
 IPv6 address is in 128-bit records represented as eight fields of up to four hexadecimal digits with a colon separates each field (:). For example, 'fe80::215:c5ff:fe03:4dc7'. The symbol '::' is a special syntax that can be used as a shorthand way of representing multiple 16-bit groups of contiguous zeros; but it can only appear once. It also used a following `legally IPv4 address`. For example, '::192.1.2.34'.
- <end_ipv6_addr>** : End IPv6 address.
 IPv6 address is in 128-bit records represented as eight fields of up to four hexadecimal digits with a colon separates each field (:). For example, 'fe80::215:c5ff:fe03:4dc7'. The symbol '::' is a special syntax that can be used as a shorthand way of representing multiple 16-bit groups of contiguous zeros; but it can only appear once. It also used a following `legally IPv4 address`. For example, '::192.1.2.34'.
- web** : Indicates that the host can access the switch from HTTP/HTTPS
- snmp** : Indicates that the host can access the switch from SNMP

telnet : Indicates that the host can access the switch from TELNET/SSH

Example:

Add access management list from 2001::0001 to 2001::0100 via web interface.

```
IGS-10020MT:/> security switch access add 2001::0001 2001::0100 web
```

Security Switch Access Delete

Description:

Delete access management entry.

Syntax:

Security Switch Access Delete <access_id>

Parameters:

<access_id>: entry index (1-16)

Example:

Delete access management ID 1

```
IGS-10020MT:/>security switch access delete 1
```

Security Switch Access Lookup

Description:

Lookup access management entry.

Syntax:

Security Switch Access Lookup [<access_id>]

Parameters:

<access_id> : entry index (1-16)

Example:

Lookup access management entry.

```
IGS-10020MT:/>security switch access lookup 1
```

Security Switch Access Clear

Description:

Clear access management entry.

Syntax:

Security Switch Access Clear

Example:

Clear access management entry.

```
IGS-10020MT:/>security switch access clear
```

Security Switch Access Statistics

Description:

Show or clear access management statistics.

Syntax:

Security Switch Access Statistics [clear]

Parameters:

clear: Clear access management statistics

Example:

Show access management statistics.

```
IGS-10020MT:/>security switch access statistics
```

Access Management Statistics:

HTTP	Receive:	0	Allow:	0	Discard:	0
HTTPS	Receive:	0	Allow:	0	Discard:	0
SNMP	Receive:	0	Allow:	0	Discard:	0
TELNET	Receive:	0	Allow:	0	Discard:	0
SSH	Receive:	0	Allow:	0	Discard:	0

Security Switch SNMP Configuration

Description:

Show SNMP configuration.

Syntax:

Security Switch SNMP Configuration

Security Switch SNMP Mode

Description:

Set or show the SNMP mode.

Syntax:

Security Switch SNMP Mode [enable|disable]

Parameters:

enable : Enable SNMP

disable: Disable SNMP

(default: Show SNMP mode)

Default Setting:

enable

Example:

Disable SNMP mode.

```
IGS-10020MT:/>security switch snmp mode disable
```

Security Switch SNMP Version

Description:

Set or show the SNMP protocol version.

Syntax:

Security Switch SNMP Version [1|2c|3]

Parameters:

- 1 : SNMP version 1
 - 2c: SNMP version 2c
 - 3 : SNMP version 3
- (default: Show SNMP version)

Default Setting:

2c

Example:

Set SNMP in version 3.

```
IGS-10020MT:/>security switch snmp version 3
```

Security Switch SNMP Read Community

Description:

Set or show the community string for SNMP read access.

Syntax:

Security Switch SNMP Read Community [<community>]

Parameters:

<community>: Community string. Use 'clear' or "" to clear the string
(default: Show SNMP read community)

Default Setting:

public

Example:

Set SNMP read community private.

```
IGS-10020MT:/>security switch snmp read community private
```

Security Switch SNMP Write Community

Description:

Set or show the community string for SNMP write access.

Syntax:

Security Switch SNMP Write Community [<community>]

Parameters:

<community>: Community string. Use 'clear' or "" to clear the string
(default: Show SNMP write community)

Default Setting:

private

Example:

Set public value in SNMP write community.

```
IGS-10020MT:/>security switch snmp write community public
```

Security Switch SNMP Trap Mode

Description:

Set or show the SNMP trap mode.

Syntax:

Security Switch SNMP Trap Mode [enable|disable]

Parameters:

enable : Enable SNMP traps

disable: Disable SNMP traps

(default: Show SNMP trap mode)

Default Setting:

disable

Example:

Enable SNMP trap mode.

```
IGS-10020MT:/>security switch snmp trap mode enable
```

Security Switch SNMP Trap Version**Description:**

Set or show the SNMP trap protocol version.

Syntax:

Security Switch SNMP Trap Version [1|2c|3]

Parameters:

1 : SNMP version 1

2c: SNMP version 2c

3 : SNMP version 3

(default: Show SNMP trap version)

Default Setting:

1

Example:

Set SNMP trap version in version 2c.

```
IGS-10020MT:/>security switch snmp trap version 2c
```

Security Switch SNMP Trap Community**Description:**

Set or show the community string for SNMP traps.

Syntax:

Security Switch SNMP Trap Community [<community>]

Parameters:

<community>: Community string. Use 'clear' or "" to clear the string

(default: Show SNMP trap community)

Default Setting:

public

Example:

Set private value for SNMP trap community.

```
IGS-10020MT:/>security switch snmp trap community private
```

Security Switch SNMP Trap Destination**Description:**

Set or Show the SNMP trap destination address.

Syntax:

Security Switch SNMP Trap Destination [<ip_addr_string>]

Parameters:

<ip_addr_string>: IP host address (a.b.c.d) or a host name string

Example:

Set SNMP trap destination address for 192.168.0.20

```
IGS-10020MT:/>security switch snmp trap destination 192.168.0.20
```

Security Switch SNMP Trap IPv6 Destination**Description:**

Set or Show the SNMP trap destination IPv6 address.

Syntax:

Security Switch SNMP Trap IPv6 Destination [<ipv6_addr>]

Parameters:

<ipv6_addr>: IPv6 address is in 128-bit records represented as eight fields of up to four hexadecimal digits with a colon separates each field (:). For example, four hexadecimal digits with a colon separates each field (:). For example, fe80::215:c5ff:fe03:4dc7'. The symbol '::' is a special syntax that can be used as a shorthand way of representing multiple 16-bit groups of contiguous zeros; but it can only appear once. It also used a following legally IPv4 address. For example, ':::192.1.2.34'.

Example:

Set SNMP trap IPv6 destination address for 2001::0001

```
IGS-10020MT:/>security switch snmp trap ipv6 destination 2001::0001
```

Security Switch SNMP Trap Authentication Failure

Description:

Set or show the SNMP authentication failure trap mode.

Syntax:

Security Switch SNMP Trap Authentication Failure [enable|disable]

Parameters:

enable : Enable SNMP trap authentication failure

disable: Disable SNMP trap authentication failure

(default: Show SNMP trap authentication failure mode)

Default Setting:

enable

Example:

Disable SNMP trap authentication failure

```
IGS-10020MT:/>security switch snmp trap authentication failure disable
```

Security Switch SNMP Trap Link-up

Description:

Set or show the port link-up and link-down trap mode.

Syntax:

Security Switch SNMP Trap Link-up [enable|disable]

Parameters:

enable : Enable SNMP trap link-up and link-down

disable: Disable SNMP trap link-up and link-down

(default: Show SNMP trap link-up and link-down mode)

Default Setting:

enable

Example:

Disable SNMP trap link-up

```
IGS-10020MT:/>security switch snmp trap link-up disable
```

Security Switch SNMP Trap Inform Mode

Description:

Set or show the SNMP trap inform mode.

Syntax:

Security Switch SNMP Trap Inform Mode [enable|disable]

Parameters:

- enable** : Enable SNMP trap inform
- disable**: Disable SNMP trap inform
- (default: Show SNMP inform mode)

Default Setting:

enable

Example:

Disable SNMP trap inform mode.

```
IGS-10020MT:/>security switch snmp trap inform mode disable
```

Security Switch SNMP Trap Inform Timeout

Description:

Set or show the SNMP trap inform timeout (usecs).

Syntax:

Security Switch SNMP Trap Inform Timeout [<timeout>]

Parameters:

- <timeout>**: SNMP trap inform timeout (0-2147 seconds)
- (default: Show SNMP trap inform timeout)

Default Setting:

1

Example:

Set SNMP trap inform timeout in 20sec.

```
IGS-10020MT:/>security switch snmp trap inform timeout 20
```

Security Switch SNMP Trap Inform Retry Times**Description:**

Set or show the SNMP trap inform retry times.

Syntax:

Security Switch SNMP Trap Inform Retry Times [<retries>]

Parameters:

<retries>: SNMP trap inform retransmitted times (0-255)

(default: Show SNMP trap inform retry times)

Default Setting:

5

Example:

Set SNMP trap inform retry times in 10.

```
IGS-10020MT:/>security switch snmp trap inform retry times 10
```

Security Switch SNMP Trap Probe Security Engine ID**Description:**

Show SNMP trap security engine ID probe mode.

Syntax:

Security Switch SNMP Trap Probe Security Engine ID [enable|disable]

Parameters:**enable** : Enable SNMP trap security engine ID probe**disable**: Disable SNMP trap security engine ID probe

(default: Show SNMP trap security engine ID probe mode)

Default Setting:

enable

Example:

Disable SNMP trap probe security engine ID

```
IGS-10020MT:/>security switch snmp trap probe security engine id disable
```

Security Switch SNMP Trap Security Engine ID

Description:

Set or show SNMP trap security engine ID.

Syntax:

Security Switch SNMP Trap Security Engine ID [<engineid>]

Parameters:

<engineid>: Engine ID, the format may not be all zeros or all 'ff'H and is restricted to 5 - 32 octet string

Example:

Set the SNMP trap security engine ID

```
IGS-10020MT:/>security switch snmp trap security engine id 800007e5017f000011
```

Security Switch SNMP Trap Security Name

Description:

Set or show SNMP trap security name.

Syntax:

Security Switch SNMP Trap Security Name [<security_name>]

Parameters:

<security_name>: A string representing the security name for a principal (default: Show SNMP trap security name). The allowed string length is (1-32), and the allowed content is ASCII characters from 33 to 126

Example:

Set the SNMP trap security name

```
IGS-10020MT:/>security switch snmp trap security name 12345678
```

Security Switch SNMP Engine ID**Description:**

Set or show SNMPv3 local engine ID.

Syntax:

Security Switch SNMP Engine ID [<engineid>]

Parameters:

<engineid>: Engine ID, the format may not be all zeros or all 'ff'H and is restricted to 5 - 32 octet string

Default Setting:

800007e5017f000001

Example:

Set 800007e5017f000002 for SNMPv3 local engine ID

```
IGS-10020MT:/>security switch snmp engine id 800007e5017f000002
```

Security Switch SNMP Community Add**Description:**

Add or modify SNMPv3 community entry.

The entry index key is <community>.

Syntax:

Security Switch SNMP Community Add <community> [<ip_addr>] [<ip_mask>]

Parameters:

<community>: Community string

<ip_addr> : IP address (a.b.c.d), default: Show IP address

<ip_mask> : IP subnet mask (a.b.c.d), default: Show IP mask

Example:

Add SNMPv3 community entry.

```
IGS-10020MT:/>security switch snmp community add public 192.168.0.20 255.255.255.0
```

Security Switch SNMP Community Delete

Description:

Delete SNMPv3 community entry.

Syntax:

Security Switch SNMP Community Delete <index>

Parameters:

<index>: entry index (1-64)

Example:

Delete SNMPv3 community entry

```
IGS-10020MT:/>security switch snmp community delete 3
```

Security Switch SNMP Community Lookup

Description:

Lookup SNMPv3 community entry.

Syntax:

Security Switch SNMP Community Lookup [<index>]

Parameters:

<index>: entry index (1-64)

Example:

Lookup SNMPv3 community entry

```
IGS-10020MT:/>security switch snmp community lookup
```

Idx	Community	Source IP	Source Mask
1	public	192.168.0.20	255.255.255.0

2	private	0.0.0.0	0.0.0.0
Number of entries: 2			

Security Switch SNMP User Add

Description:

Add SNMPv3 user entry.

The entry index key are <engineid> and <user_name> and it doesn't allow modify.

Syntax:

Security Switch SNMP User Add <engineid> <user_name> [MD5|SHA] [<auth_password>] [DES] [<priv_password>]

Parameters:

- <engineid>** : Engine ID, the format may not be all zeros or all 'ff'H and is restricted to 5 - 32 octet string
- <user_name>** : A string identifying the user name that this entry should belong to. The name of "None" is reserved.
The allowed string length is (1-32), and the allowed content is ASCII characters from 33 to 126
- md5** : An optional flag to indicate that this user using MD5 authentication protocol. The allowed length is (8-32), and the allowed content is ASCII characters from 33 to 126
- sha** : An optional flag to indicate that this user using SHA authentication protocol. The allowed length is (8-40), and the allowed content is ASCII characters from 33 to 126
- <auth_password>**: A string identifying the authentication pass phrase
- des** : An optional flag to indicate that this user using DES privacy protocol privacy protocol should belong to.
The allowed string length is (8-32), and the allowed content is ASCII characters from 33 to 126
- <priv_password>**: A string identifying the privacy pass phrase.
The allowed string length is (8-40), and the allowed content is ASCII characters from 33 to 126

Example:

Add SNMPv3 user entry

```
IGS-10020MT:/>security switch snmp user add 800007e5017f000003 admin_snmpv3 md5
12345678 des abcdefgh
```

Security Switch SNMP User Delete

Description:

Delete SNMPv3 user entry.

Syntax:

Security Switch SNMP User Delete <index>

Parameters:

<index>: entry index (1-64)

Example:

Delete SNMPv3 user entry

```
IGS-10020MT:/>security switch snmp user delete 1
```

Security Switch SNMP User Changekey**Description:**

Change SNMPv3 user password.

Syntax:

Security Switch SNMP User Changekey <engineid> <user_name> <auth_password> [<priv_password>]

Parameters:

<engineid> : Engine ID, the format may not be all zeros or all 'ff' and is restricted to 5 - 32 octet string

<user_name> : A string identifying the user name that this entry should belong to. The name of "None" is reserved.

The allowed string length is (1-32), and the allowed content is ASCII characters from 33 to 126

<auth_password>: A string identifying the authentication pass phrase

<priv_password>: A string identifying the privacy pass phrase.

The allowed string length is (8-40), and the allowed content is ASCII characters from 33 to 126

Example:

Delete SNMPv3 user entry

```
IGS-10020MT:/>security switch snmp user changekey 800007e5017f000003 admin_snmpv3
87654321 12345678
```

Security Switch SNMP User Lookup**Description:**

Lookup SNMPv3 user entry.

Syntax:

Security Switch SNMP User Lookup [<index>]

Parameters:

<index>: entry index (1-64)

Example:

Lookup SNMPv3 user entry

```
IGS-10020MT:/>security switch snmp user lookup
Idx Engine ID   User Name                Level      Auth  Priv
-----
1   Remote      admin_snmpv3            Auth, Priv MD5   DES
Number of entries: 1
```

Security Switch SNMP Group Add

Description:

Add or modify SNMPv3 group entry.

The entry index key are <security_model> and <security_name>.

Syntax:

Security Switch SNMP Group Add <security_model> <security_name> <group_name>

Parameters:

<security_model>: v1 - Reserved for SNMPv1

v2c - Reserved for SNMPv2c

usm - User-based Security Model (USM)

<security_name> : A string identifying the security name that this entry should belong to. The allowed string length is (1-32), and the allowed content is ASCII characters from 33 to 126

<group_name> : A string identifying the group name that this entry should belong to. The allowed string length is (1-32), and the allowed content is ASCII characters from 33 to 126

Example:

Add SNMPv3 group entry

```
IGS-10020MT:/>security switch snmp group add usm admin_snmpv3 group_snmpv3
```

Security Switch SNMP Group Delete

Description:

Delete SNMPv3 group entry.

Syntax:

Security Switch SNMP Group Delete <index>

Parameters:

<index>: entry index (1-64)

Example:

Delete SNMPv3 group entry

```
IGS-10020MT:/>security switch snmp group delete 1
```

Security Switch SNMP Group Lookup

Description:

Lookup SNMPv3 group entry.

Syntax:

Security Switch SNMP Group Lookup [<index>]

Parameters:

<index>: entry index (1-64)

Example:

Lookup SNMPv3 group entry

```
IGS-10020MT:/>security switch snmp group lookup
```

Idx	Model	Security Name	Group Name
1	v1	public	default_ro_group
2	v1	private	default_rw_group
3	v2c	public	default_ro_group
4	v2c	private	default_rw_group
5	usm	default_user	default_rw_group

Number of entries: 5

Security Switch SNMP View Add

Description:

Add or modify SNMPv3 view entry.

The entry index key are <view_name> and <oid_subtree>.

Syntax:

Security Switch SNMP View Add <view_name> [included|excluded] <oid_subtree>

Parameters:

- <view_name>** : A string identifying the view name that this entry should belong to. The allowed string length is (1-32), and the allowed content is ASCII characters from 33 to 126
- included** : An optional flag to indicate that this view subtree should included
- excluded** : An optional flag to indicate that this view subtree should excluded
- <oid_subtree>**: The OID defining the root of the subtree to add to the named view

Example:

Add SNMPv3 view entry

```
IGS-10020MT:/>security switch snmp view add snmpv3_view include .1
```

Security Switch SNMP View Delete

Description:

Delete SNMPv3 view entry.

Syntax:

Security Switch SNMP View Delete <index>

Parameters:

- <index>**: entry index (1-64)

Example:

Delete SNMPv3 view entry

```
IGS-10020MT:/>security switch snmp view delete 3
```

Security Switch SNMP View Lookup

Description:

Lookup SNMPv3 view entry.

Syntax:

Security Switch SNMP View Lookup [<index>]

Parameters:

<index>: entry index (1-64)

Example:

Lookup SNMPv3 view entry

```
IGS-10020MT:/>security switch snmp view lookup
Idx  View Name                View Type  OID Subtree
-----
1    default_view             included   .1
2    snmpv3_viwe             included   .1

Number of entries: 2
```

Security Switch SNMP Access Add

Description:

Add or modify SNMPv3 access entry.

The entry index key are <group_name>, <security_model> and <security_level>.

Syntax:

Security Switch SNMP Access Add <group_name> <security_model> <security_level> [<read_view_name>]
[<write_view_name>]

Parameters:

<group_name> : A string identifying the group name that this entry should belong to. The allowed string length is (1-32), and the allowed content is ASCII characters from 33 to 126

<security_model> : any - Accepted any security model (v1|v2c|usm)

v1 - Reserved for SNMPv1

v2c - Reserved for SNMPv2c

usm - User-based Security Model (USM)

<security_level> : noAuthNoPriv - None authentication and none privacy

AuthNoPriv - Authentication and none privacy

AuthPriv - Authentication and privacy

<read_view_name> : The name of the MIB view defining the MIB objects for which this request may request the current values.

The name of "None" is reserved.

The allowed string length is (1-32), and the allowed content is ASCII characters from 33 to 126

<write_view_name>: The name of the MIB view defining the MIB objects for which this request may potentially SET new values.

The name of "None" is reserved.

The allowed string length is (1-32), and the allowed content is ASCII characters from 33 to 126

Example:

Add SNMPv3 access entry

```
IGS-10020MT:/>security switch snmp access add group_snmpv3 usm authpriv  
snmpv3_view snmpv3_view
```

Security Switch SNMP Access Delete

Description:

Delete SNMPv3 access entry.

Syntax:

Security Switch SNMP Access Delete <index>

Parameters:

<index>: entry index (1-64)

Example:

Delete SNMPv3 access entry

```
IGS-10020MT:/>security switch snmp access delete 3
```

Security Switch SNMP Access Lookup

Description:

Lookup SNMPv3 access entry.

Syntax:

Security Switch SNMP Access Lookup [<index>]

Parameters:

<index>: entry index (1-64)

Example:

Lookup SNMPv3 access entry

```
IGS-10020MT:/>security switch snmp access lookup
Idx Group Name                Model Level
-----
1  default_ro_group           any  NoAuth, NoPriv
2  default_rw_group           any  NoAuth, NoPriv

Number of entries: 2
```

Security Network Psec Switch

Description:

Show Port Security status.

Syntax:

Security Network Psec Switch [<port_list>]

Parameters:

<port_list>: Port list or 'all', default: All ports

Example:

Show port security status.

```
IGS-10020MT:/>security network psec switch
Users:
L = Limit Control
8 = 802.1X
D = DHCP Snooping
V = Voice VLAN

Port  Users  State          MAC Cnt
----  ----  -
1     ----  No users      0
2     ----  No users      0
3     ----  No users      0
```

4	----	No users	0
5	----	No users	0
6	----	No users	0
7	----	No users	0
8	----	No users	0
9	----	No users	0
10	----	No users	0

Security Network Psec Port

Description:

Show MAC Addresses learned by Port Security.

Syntax:

Security Network Psec Port [<port_list>]

Parameters:

<port_list>: Port list or 'all', default: All ports

Example:

Show MAC address learned on port 1

```
IGS-10020MT:/>security network psec port 1

Port 1:
-----

MAC Address      VID   State   Added           Age/Hold Time
-----
<none>
```

Security Network Limit Configuration

Description:

Show Limit Control configuration.

Syntax:

Security Network Limit Configuration [<port_list>]

Parameters:

<port_list>: Port list or 'all', default: All ports

Example:

Show Limit Control configuration.

```
IGS-10020MT:/>security network limit configuration

Port Security Limit Control Configuration:
=====

Mode      : Disabled
Aging     : Disabled
Age Period: 3600

Port  Mode      Limit  Action
----  -
1     Disabled    4     None
2     Disabled    4     None
3     Disabled    4     None
4     Disabled    4     None
5     Disabled    4     None
6     Disabled    4     None
7     Disabled    4     None
8     Disabled    4     None
9     Disabled    4     None
10    Disabled    4     None
```

Security Network Limit Mode

Description:

Set or show global enabledness.

Syntax:

Security Network Limit Mode [enable|disable]

Parameters:

enable : Globally enable port security

disable : Globally disable port security

(default: Show current global enabledness of port security limit control)

Default Setting:

disable

Example:

Enable the limit mode

```
IGS-10020MT:/>security network limit mode enable
```

Security Network Limit Aging**Description:**

Set or show aging enabledness.

Syntax:

Security Network Limit Aging [enable|disable]

Parameters:**enable** : Enable aging**disable** : Disable aging

(default: Show current enabledness of aging)

Default Setting:

disable

Example:

Enable limit aging

```
IGS-10020MT:/>security network limit aging enable
```

Security Network Limit Agetime**Description:**

Time in seconds between check for activity on learned MAC addresses.

Syntax:

Security Network Limit Agetime [<age_time>]

Parameters:**<age_time>**: Time in seconds between checks for activity on a MAC address (10-10000000 seconds)

(default: Show current age time)

Default Setting:

3600

Example:

Set age time in 100sec.

```
IGS-10020MT:/>security network limit agetime 100
```

Security Network Limit Port**Description:**

Set or show per-port enabledness.

Syntax:

Security Network Limit Port [<port_list>] [enable|disable]

Parameters:

<port_list>: Port list or 'all', default: All ports

enable : Enable port security on this port**disable** : Disable port security on this port

(default: Show current port enabledness of port security limit control)

Default Setting:

disable

Example:

Enable port limit for port 1

```
IGS-10020MT:/>security network limit port 1 enable
```

Security Network Limit Limit**Description:**

Set or show the max. number of MAC addresses that can be learned on this set of ports.

Syntax:

Security Network Limit Limit [<port_list>] [<limit>]

Parameters:

<port_list>: Port list or 'all', default: All ports

<limit> : Max. number of MAC addresses on this port

(default: Show current limit)

Default Setting:

4

Example:

Set limit in 5

```
IGS-10020MT:/>security network limit limit 1-10 5
```

Security Network Limit Action**Description:**

Set or show the action involved with exceeding the limit.

Syntax:

Security Network Limit Action [<port_list>] [none|trap|shut|trap_shut]

Parameters:

<port_list> : Port list or 'all', default: All ports

none|trap|shut|trap_shut: Action to be taken in case the number of MAC addresses exceeds the limit

none : Don't do anything

trap : Send an SNMP trap

shut : Shutdown the port

trap_shut: Send an SNMP trap and shutdown the port

(default: Show current action)

Default Setting:

none

Example:

Set trap mode for limit action for port 1

```
IGS-10020MT:/>security network limit action 1 trap
```

Security Network Limit Reopen**Description:**

Reopen one or more ports whose limit is exceeded and shut down.

Syntax:

Security Network Limit Reopen [<port_list>]

Parameters:

<port_list>: Port list or 'all', default: All ports

Example:

Reopen port 1

```
IGS-10020MT:/>security network limit reopen 1
```

Security Network NAS Configuration**Description:**

Show 802.1X configuration.

Syntax:

Security Network NAS Configuration [<port_list>]

Parameters:

<port_list>: Port list or 'all', default: All ports

Example:

Show 802.1X configuration of port 1

```
IGS-10020MT:/>security network nas configuration 1
```

802.1X Configuration:

```
=====
```

```
Mode           : Disabled
Reauth.        : Disabled
Reauth. Period : 3600
EAPOL Timeout  : 30
Age Period     : 300
Hold Time      : 10
RADIUS QoS     : Disabled
RADIUS VLAN    : Disabled
Guest VLAN     : Disabled
```

Guest VLAN ID : 1				
Max. Reauth Count: 2				
Allow Guest VLAN if EAPOL Frame Seen: Disabled				
Port	Admin State	Port State	Last Source	Last ID
1	Force Authorized	Globally Disabled	-	-

Security Network NAS Mode

Description:

Set or show the global NAS enabledness.

Syntax:

Security Network NAS Mode [enable|disable]

Parameters:

enable : Globally enable 802.1X

disable: Globally disable 802.1X

(default: Show current 802.1X global enabledness)

Default Setting:

disable

Example:

Enable IEEE802.1X function

```
IGS-10020MT:/>security network nas mode enable
```

Security Network NAS State

Description:

Set or show the port security state.

Syntax:

Security Network NAS State [<port_list>] [auto|authorized|unauthorized|single|multi|macbased]

Parameters:

<port_list>: Port list or 'all', default: All ports

- auto** : Port-based 802.1X Authentication
- authorized** : Port access is allowed
- unauthorized**: Port access is not allowed
- single** : Single Host 802.1X Authentication
- multi** : Multiple Host 802.1X Authentication
- macbased** : Switch authenticates on behalf of the client
(default: Show 802.1X state)

Default Setting:

none

Example:

Show the port 1 security state.

```
IGS-10020MT:/>security network nas state 1
```

Port	Admin State	Port State	Last Source	Last ID
1	Force Authorized	Globally Disabled	-	-

Security Network NAS Reauthentication

Description:

Set or show Reauthentication enabledness.

Syntax:

Security Network NAS Reauthentication [enable|disable]

Parameters:

- enable** : Enable reauthentication
- disable**: Disable reauthentication
(default: Show current reauthentication mode)

Default Setting:

disable

Example:

Enable reauthentication function.

```
IGS-10020MT:/>security network nas reauthentication enable
```

Security Network NAS ReauthPeriod

Description:

Set or show either global enabledness (use the global keyword) or per-port enabledness of RADIUS-assigned VLAN.

Syntax:

Security Network NAS RADIUS_VLAN [global|<port_list>] [enable|disable]

Parameters:

global : Select the global RADIUS-assigned VLAN setting

<port_list>: Select the per-port RADIUS-assigned VLAN setting

(default: Show current per-port RADIUS-assigned VLAN enabledness)

enable : Enable RADIUS-assigned VLAN either globally or on one or more ports

disable: Disable RADIUS-assigned VLAN either globally or on one or more ports

(default: Show current RADIUS-assigned VLAN enabledness)

Default Setting:

disable

Example:

Enable RADIUS-assigned VLAN.

```
IGS-10020MT:/>security network nas radius_vlan enable
```

Security Network NAS EapolTimeout

Description:

Set or show the time between EAPOL retransmissions.

Syntax:

Security Network NAS EapolTimeout [<eapol_timeout>]

Parameters:

<eapol_timeout>: Time between EAPOL retransmissions (1-65535 seconds)

(default: Show current EAPOL retransmission timeout)

Default Setting:

30

Example:

Set the time between EAPOL retransmissions for 100sec.

```
IGS-10020MT:/>security network nas eapoltimeout 100
```

Security Network NAS Agetime**Description:**

Time in seconds between check for activity on successfully authenticated MAC addresses.

Syntax:

Security Network NAS Agetime [<age_time>]

Parameters:

<age_time>: Time between checks for activity on a MAC address that succeeded authentication
(default: Show current age time)

Default Setting:

300

Example:

Set NAS age time in 1000sec

```
IGS-10020MT:/>security network nas agetime 1000
```

Security Network NAS Holdtime**Description:**

Time in seconds before a MAC-address that failed authentication gets a new authentication chance.

Syntax:

Security Network NAS Holdtime [<hold_time>]

Parameters:

<hold_time>: Hold time before MAC addresses that failed authentication expire
(default: Show current hold time)

Default Setting:

10

Example:

Set NAS hold time in 100sec

```
IGS-10020MT:/>security network nas holdtime 100
```

Security Network NAS RADIUS_QoS**Description:**

Set or show either global enabledness (use the global keyword) or per-port enabledness of RADIUS-assigned QoS.

Syntax:

Security Network NAS RADIUS_QoS [global|<port_list>] [enable|disable]

Parameters:

global : Select the global RADIUS-assigned QoS setting

<port_list>: Select the per-port RADIUS-assigned QoS setting

(default: Show current per-port RADIUS-assigned QoS enabledness)

enable : Enable RADIUS-assigned QoS either globally or on one or more ports

disable: Disable RADIUS-assigned QoS either globally or on one or more ports

(default: Show current RADIUS-assigned QoS enabledness)

Default Setting:

disable

Example:

Enable NAS RADIUS QoS

```
IGS-10020MT:/>security network nas radius_qos enable
```

Security Network NAS RADIUS_VLAN**Description:**

Set or show either global enabledness (use the global keyword) or per-port enabledness of RADIUS-assigned VLAN.

Syntax:

Security Network NAS RADIUS_VLAN [global|<port_list>] [enable|disable]

Parameters:

global : Select the global RADIUS-assigned VLAN setting

<port_list>: Select the per-port RADIUS-assigned VLAN setting

(default: Show current per-port RADIUS-assigned VLAN enabledness)

enable : Enable RADIUS-assigned VLAN either globally or on one or more ports

disable: Disable RADIUS-assigned VLAN either globally or on one or more ports

(default: Show current RADIUS-assigned VLAN enabledness)

Default Setting:

disable

Example:

Enable NAS RADIUS VLAN

```
IGS-10020MT:/>security network nas radius_vlan enable
```

Security Network NAS Guest_VLAN

Description:

Set or show either global enabledness and parameters (use the global keyword) or per-port enabledness of Guest VLAN

Unless the 'global' keyword is used, the <reauth_max> and <allow_if_eapol_seen> parameters will not be unused..

Syntax:

Security Network NAS Guest_VLAN [global|<port_list>] [enable|disable] [<vid>] [<reauth_max>] [<allow_if_eapol_seen>]

Parameters:

global: Select the global Guest VLAN setting

<port_list>: Select the per-port Guest VLAN setting

(default: Show current per-port Guest VLAN enabledness)

enable|disable: enable : Enable Guest VLAN either globally or on one or more ports

disable: Disable Guest VLAN either globally or on one or more ports

(default: Show current Guest VLAN enabledness)

<vid>: Guest VLAN ID used when entering the Guest VLAN. Use the 'global' keyword to change it

(default: Show current Guest VLAN ID)

<reauth_max>: The value can only be set if you use the 'global' keyword in the beginning of the command. The number of times a Request Identity EAPOL frame is sent without response before considering entering the Guest VLAN

(default: Show current Maximum Reauth Count value)

<allow_if_eapol_seen>: The value can only be set if you use the 'global' keyword in the beginning of the command.

disable:The Guest VLAN can only be entered if no EAPOL frames have been received on a port for the lifetime of the port

enable :The Guest VLAN can be entered even if an EAPOL frame has been received during the lifetime of the port

(default: Show current setting)

Default Setting:

disable

Example:

Enable NAS guest VLAN

```
IGS-10020MT:/>security network nas guest_vlan enable
```

Security Network NAS Authenticate**Description:**

Refresh (restart) 802.1X authentication process.

Syntax:

Security Network NAS Authenticate [<port_list>] [now]

Parameters:

<port_list>: Port list or 'all', default: All ports

now: Force reauthentication immediately

Example:

Start NAS authentication now for port 1.

```
IGS-10020MT:/>security network nas authenticate 1 now
```

Security Network NAS Statistics**Description:**

Show or clear 802.1X statistics.

Syntax:

Security Network NAS Statistics [<port_list>] [clear|eapol|radius]

Parameters:

<port_list>: Port list or 'all', default: All ports

clear : Clear statistics

eapol : Show EAPOL statistics

radius : Show Backend Server statistics

(default: Show all statistics)

Example:

Show 802.1X statistics in port 1

```
IGS-10020MT:/>security network nas statistics 1
```

Port 1 EAPOL Statistics:			
Rx Total:	0	Tx Total:	0
Rx Response/Id:	0	Tx Request/Id:	0
Rx Response:	0	Tx Request:	0
Rx Start:	0		
Rx Logoff:	0		
Rx Invalid Type:	0		
Rx Invalid Length:	0		
Port 1 Backend Server Statistics:			
Rx Access Challenges:	0	Tx Responses:	0
Rx Other Requests:	0		
Rx Auth. Successes:	0		
Rx Auth. Failures:	0		

Security Network ACL Configuration

Description:

Show ACL Configuration.

Syntax:

Security Network ACL Configuration [<port_list>]

Parameters:

<port_list>: Port list or 'all', default: All ports

Security Network ACL Action

Description:

Set or show the ACL port default action.

Syntax:

Security Network ACL Action [<port_list>] [permit|deny] [<rate_limiter>] [<port_copy>] [<logging>] [<shutdown>]

Parameters:

- <port_list>** : Port list or 'all', default: All ports
- permit** : Permit forwarding (default)
- deny** : Deny forwarding
- <rate_limiter>**: Rate limiter number (1-15) or 'disable'
- <port_copy>** : Port number for copy of frames or 'disable'
- <logging>** : System logging of frames: log|log_disable
- <shutdown>** : Shut down ingress port: shut|shut_disable

Example:

Show ACL action in port 1

```
IGS-10020MT:/>security network acl action 1
```

Port	Action	Rate Limiter	Port Copy	Mirror	Logging	Shutdown	Counter
1	Permit	Disabled	Disabled	Disabled	Disabled	Disabled	0

Security Network ACL Policy

Description:

Set or show the ACL port policy.

Syntax:

Security Network ACL Policy [<port_list>] [<policy>]

Parameters:

- <port_list>**: Port list or 'all', default: All ports
- <policy>** : Policy number (1-8)

Default Setting:

1

Example:

Set ACL policy 2 for port 1

```
IGS-10020MT:/>security network acl policy 1 2
```

Security Network ACL Rate

Description:

Set or show the ACL rate limiter.

Syntax:

Security Network ACL Rate [<rate_limiter_list>] [<rate_unit>] [<rate>]

Parameters:

<rate_limiter_list>: Rate limiter list (1-16), default: All rate limiters

<rate_unit> : IP flags: pps|kpbs, default: pss

<rate> : Rate in pps (0-100) or kbps (0, 100, 2*100, 3*100, ..., 1000000)

Default Setting:

1

Example:

Set rate limit value in 100 for port 1

```
IGS-10020MT:/>security network acl rate 1 100
```

Security Network ACL Add

Description:

Add or modify Access Control Entry (ACE).

If the ACE ID parameter <ace_id> is specified and an entry with this ACE ID already exists, the ACE will be modified.

Otherwise, a new ACE will be added. If the ACE ID is not specified, the next available ACE ID will be used.

If the next ACE ID parameter <ace_id_next> is specified, the ACE will be placed before this ACE in the list. If the next ACE ID is not specified, the ACE will be placed last in the list.

If the Switch keyword is used, the rule applies to all ports.

If the Port keyword is used, the rule applies to the specified port only. If the Policy keyword is used, the rule applies to all ports configured with the specified policy. The default is that the rule applies to all ports.

Syntax:

```
Security Network ACL Add [<ace_id>] [<ace_id_next>] [switch | (port <port_list>) | (policy <policy>)] [<tagged>] [<vid>]
[<tag_prio>] [<dmac_type>] [(etype [<etype>] [<smac>] [<dmac>]) | (arp [<sip>] [<dip>] [<smac>] [<arp_opcode>]
[<arp_flags>]) | (ip [<sip>] [<dip>] [<protocol>] [<ip_flags>]) | (icmp [<sip>] [<dip>] [<icmp_type>] [<icmp_code>])
```

[<ip_flags>] | (udp [<sip>] [<dip>] [<sport>] [<dport>] [<ip_flags>]) | (tcp [<sip>] [<dip>] [<sport>] [<dport>] [<ip_flags>] [<tcp_flags>]) [permit|deny] [<rate_limiter>] [<port_copy>] [<mirror>] [<logging>] [<shutdown>]

Parameters:

<ace_id> : ACE ID (1-256), default: Next available ID

<ace_id_next> : Next ACE ID (1-256), default: Add ACE last

switch : Switch ACE keyword

port : Port ACE keyword

<port_list> : Port list or 'all', default: All ports

policy : Policy ACE keyword

<policy> : Policy number (1-8)

<tagged> : Tagged of frames: any|enable|disable

<vid> : VLAN ID (1-4095) or 'any'

<tag_prio> : VLAN tag priority (0-7) or 'any'

<dmac_type> : DMAC type: any|unicast|multicast|broadcast

etype : Ethernet Type keyword

<etype> : Ethernet Type: 0x600 - 0xFFFF or 'any' but excluding, 0x800(IPv4) 0x806(ARP) and 0x86DD(IPv6)

<smac> : Source MAC address (xx-xx-xx-xx-xx-xx) or 'any'

<dmac> : Destination MAC address (xx-xx-xx-xx-xx-xx) or 'any'

arp : ARP keyword

<sip> : Source IP address (a.b.c.d/n) or 'any'

<dip> : Destination IP address (a.b.c.d/n) or 'any'

<arp_opcode> : ARP operation code: any|arp|rarp|other

<arp_flags> : ARP flags: request|smac|tmac|len|ip|ether [0|1|any]

ip : IP keyword

<protocol> : IP protocol number (0-255) or 'any'

<ip_flags> : IP flags: ttl|options|fragment [0|1|any]

icmp : ICMP keyword

<icmp_type> : ICMP type number (0-255) or 'any'

<icmp_code> : ICMP code number (0-255) or 'any'

udp : UDP keyword

<sport> : Source UDP/TCP port range (0-65535) or 'any'

<dport> : Destination UDP/TCP port range (0-65535) or 'any'

tcp : TCP keyword

<tcp_flags> : TCP flags: fin|syn|rst|psh|ack|urg [0|1|any]

permit : Permit forwarding (default)

deny : Deny forwarding

<rate_limiter>: Rate limiter number (1-15) or 'disable'

<port_copy> : Port list for copy of frames or 'disable'

- <mirror>** : Mirror of frames: enable|disable
- <logging>** : System logging of frames: log|log_disable
- <shutdown>** : Shut down ingress port: shut|shut_disable

Security Network ACL Delete

Description:

Delete ACE.

Syntax:

Security Network ACL Delete <ace_id>

Parameters:

<ace_id>: ACE ID (1-256)

Example:

Delete ACE 1

```
IGS-10020MT:/>security network acl delete 1
```

Security Network ACL Lookup

Description:

Show ACE, default: All ACEs.

Syntax:

Security Network ACL Lookup [<ace_id>]

Parameters:

<ace_id>: ACE ID (1-256)

Example:

Lookup ACE 1

```
IGS-10020MT:/>security network acl lookup 1
```

Security Network ACL Clear

Description:

Clear all ACL counters.

Syntax:

Security Network ACL Clear

Example:

Clear all ACL counters.

```
IGS-10020MT:/>security network acl clear
```

Security Network ACL Status

Description:

Show ACL status.

Syntax:

Security Network ACL Status [combined|static|dhcp|upnp|arp_inspection|ipmc|ip_source_guard|conflicts]

Parameters:

combined : Shows the combined status
static : Shows the static user configured status
dhcp : Shows the status by DHCP
upnp : Shows the status by UPnP
arp_inspection : Shows the status by ARP Inspection
ip_source_guard : Shows the status by IP Source Guard
conflicts : Shows all conflict status
(default : Shows the combined status)

Example:

Show ACL status.

```
IGS-10020MT:/>security network acl status
```

Security Network DHCP Relay Configuration

Description:

Show DHCP relay configuration.

Syntax:

Security Network DHCP Relay Configuration

Example:

Show DHCP relay configuration.

```
IGS-10020MT:/>security network dhcp relay configuration

DHCP Relay Configuration:
=====

DHCP Relay Mode           : Disabled
DHCP Relay Server        : NULL
DHCP Relay Information Mode : Disabled
DHCP Relay Information Policy : replace
```

Security Network DHCP Relay Mode

Description:

Set or show the DHCP relay mode.

Syntax:

Security Network DHCP Relay Mode [enable|disable]

Parameters:

enable : Enable DHCP relay mode.

When enable DHCP relay mode operation, the agent forward and to transfer DHCP messages between the clients and the server when they are not on the same subnet domain. And the DHCP broadcast message won't flood for security considered.

disable: Disable DHCP relaly mode

(default: Show flow DHCP relaly mode)

Default Setting:

disable

Example:

Enable DHCP relay mode

```
IGS-10020MT:/>security network dhcp relay mode enable
```

Security Network DHCP Relay Server

Description:

Show or set DHCP relay server.

Syntax:

Security Network DHCP Relay Server [<ip_addr>]

Parameters:

<ip_addr>: IP address (a.b.c.d), default: Show IP address

Default Setting:

null

Example:

Set DHCP relay server in 192.168.0.20

```
IGS-10020MT:/>security network dhcp relay server 192.168.0.20
```

Security Network DHCP Relay Information Mode

Description:

Set or show DHCP relay agent information option mode.

When enable DHCP relay information mode operation, the agent insert specific information (option 82) into a DHCP message when forwarding to DHCP server and remote it from a DHCP message when transferring to DHCP client. It only works under DHCP relay operation mode enabled.

Syntax:

Security Network DHCP Relay Information Mode [enable|disable]

Parameters:

enable : Enable DHCP relay agent information option mode

disable: Disable DHCP relay agent information option mode

(default: Show DHCP relay agent information option mode)

Default Setting:

disable

Example:

Enable DHCP relay agent information option mode.

```
IGS-10020MT:/>security network dhcp relay information mode enable
```

Security Network DHCP Relay Information Policy**Description:**

Set or show the DHCP relay mode.

When enable DHCP relay information mode operation, if agent receive a DHCP message that already contains relay agent information. It will enforce the policy.

Syntax:

Security Network DHCP Relay Information Policy [replace|keep|drop]

Parameters:

replace : Replace the original relay information when receive a DHCP message that already contains it

keep : Keep the original relay information when receive a DHCP message that already contains it

drop : Drop the package when receive a DHCP message that already contains relay information

(default: Show DHCP relay information policy)

Default Setting:

replace

Example:

Keep the original relay information when receive a DHCP message that already contains it

```
IGS-10020MT:/>security network dhcp relay information policy keep
```

Security Network DHCP Relay Statistics**Description:**

Show or clear DHCP relay statistics.

Syntax:

Security Network DHCP Relay Statistics [clear]

Parameters:

clear: Clear DHCP relay statistics

Example:

Show DHCP relay statistics.

```
IGS-10020MT:/>security network dhcp relay statistics
```

Security Network DHCP Snooping Configuration

Description:

Show DHCP snooping configuration.

Syntax:

Security Network DHCP Snooping Configuration

Security Network DHCP Snooping Mode

Description:

Set or show the DHCP snooping mode.

Syntax:

Security Network DHCP Snooping Mode [enable|disable]

Parameters:

enable : Enable DHCP snooping mode.

When enable DHCP snooping mode operation, the request DHCP messages will be forwarded to trusted ports and only allowed reply packets from trusted ports.

disable: Disable DHCP snooping mode

(default: Show flow DHCP snooping mode)

Default Setting:

disable

Example:

Enable DHCP snooping mode

```
IGS-10020MT:/>security network dhcp snooping mode enable
```

Security Network DHCP Snooping Port Mode

Description:

Set or show the DHCP snooping port mode.

Syntax:

Security Network DHCP Snooping Port Mode [<port_list>] [trusted|untrusted]

Parameters:

<port_list>: Port list or 'all', default: All ports

trusted : Configures the port as trusted sources of the DHCP message

untrusted: Configures the port as untrusted sources of the DHCP message
(default: Show flow DHCP snooping port mode)

Default Setting:

trusted

Example:

Set untrusted DHCP snooping port mode in port 1

```
IGS-10020MT:/>security network dhcp snooping port mode 1 untrusted
```

Security Network DHCP Snooping Statistics

Description:

Show or clear DHCP snooping statistics.

Syntax:

Security Network DHCP Snooping Statistics [<port_list>] [clear]

Parameters:

<port_list>: Port list or 'all', default: All ports

clear : Clear DHCP snooping statistics

Example:

Show DHCP snooping statistics of port 1.

```
IGS-10020MT:/>security network dhcp snooping statistics 1
```

```
Port 1 Statistics:
```

```
-----
```

Rx Discover:	0	Tx Discover:	0
Rx Offer:	0	Tx Offer:	0
Rx Request:	0	Tx Request:	0
Rx Decline:	0	Tx Decline:	0
Rx ACK:	0	Tx ACK:	0
Rx NAK:	0	Tx NAK:	0
Rx Release:	0	Tx Release:	0
Rx Inform:	0	Tx Inform:	0
Rx Lease Query:	0	Tx Lease Query:	0
Rx Lease Unassigned:	0	Tx Lease Unassigned:	0
Rx Lease Unknown:	0	Tx Lease Unknown:	0
Rx Lease Active:	0	Tx Lease Active:	0

Security Network IP Source Guard Configuration

Description:

Show IP source guard configuration.

Syntax:

Security Network IP Source Guard Configuration

Security Network IP Source Guard Mode

Description:

Set or show IP source guard mode.

Syntax:

Security Network IP Source Guard Mode [enable|disable]

Parameters:

enable : Enable IP Source Guard

disable: Disable IP Source Guard

Default Setting:

disable

Example:

Enable IP source guard mode

```
IGS-10020MT:/>security network ip source guard mode enable
```

Security Network IP Source Guard Port Mode**Description:**

Set or show the IP Source Guard port mode.

Syntax:

Security Network IP Source Guard Port Mode [<port_list>] [enable|disable]

Parameters:

<port_list>: Port list or 'all', default: All ports

enable : Enable IP Source Guard port

disable : Disable IP Source Guard port

(default: Show IP Source Guard port mode)

Default Setting:

disable

Example:

Enable IP source guard port mode for port1~4

```
IGS-10020MT:/>security network ip source guard port mode 1-4 enable
```

Security Network IP Source Guard Limit**Description:**

Set or show the IP Source Guard port limitation for dynamic entries.

Syntax:

Security Network IP Source Guard limit [<port_list>] [<dynamic_entry_limit>|unlimited]

Parameters:

<port_list> : Port list or 'all', default: All ports

<dynamic_entry_limit>|unlimited: dynamic entry limit (0-2) or unlimited

Default Setting:

unlimited

Example:

Set IP source guard limit

```
IGS-10020MT:/>security network ip source guard 1 1
```

Security Network IP Source Guard Entry**Description:**

Add or delete IP source guard static entry.

Syntax:

Security Network IP Source Guard Entry [<port_list>] add|delete <vid> <allowed_ip> <allowed_mac>

Parameters:**<port_list>** : Port list or 'all', default: All ports**add** : Add new port IP source guard static entry**delete** : Delete existing port IP source guard static entry**<vid>** : VLAN ID (1-4095)**<allowed_ip>** : IP address (a.b.c.d), IP address allowed for doing IP source guard**<allowed_mac>**: MAC address (xx-xx-xx-xx-xx-xx), MAC address allowed for doing IP source guard**Example:**

Add IP source guard static entry.

```
IGS-10020MT:/>security network ip source guard entry 1 add 1 192.168.0.20
```

Security Network IP Source Guard Status**Description:**

Show IP source guard static and dynamic entries.

Syntax:

Security Network IP Source Guard Status [<port_list>]

Parameters:**<port_list>**: Port list or 'all', default: All ports

Example:

Show IP source guard static and dynamic entries.

```
IGS-10020MT:/>security network ip source guard status
```

Security Network ARP Inspection Configuration

Description:

Show ARP inspection configuration.

Syntax:

Security Network ARP Inspection Configuration

Example:

Show ARP inspection configuration.

```
IGS-10020MT:/>security network arp inspection configuration
```

Security Network ARP Inspection Mode

Description:

Set or show ARP inspection mode.

Syntax:

Security Network ARP Inspection Mode [enable|disable]

Parameters:

enable : Enable ARP Inspection

disable: Disable ARP Inspection

Default Setting:

disable

Example:

Enable ARP inspection mode

```
IGS-10020MT:/>security network arp inspection mode enable
```

Security Network ARP Inspection Port Mode

Description:

Set or show the ARP Inspection port mode.

Syntax:

Security Network ARP Inspection Port Mode [<port_list>] [enable|disable]

Parameters:

<port_list>: Port list or 'all', default: All ports

enable : Enable ARP Inspection port

disable : Disable ARP Inspection port

(default: Show ARP Inspection port mode)

Default Setting:

Disable

Example:

Enable the ARP inspection mode of port 1

```
IGS-10020MT:/>security network arp inspection port mode 1
```

Security Network ARP Inspection Entry

Description:

Add or delete ARP inspection static entry.

Syntax:

Security Network ARP Inspection Entry [<port_list>] add|delete <vid> <allowed_mac> <allowed_ip>

Parameters:

<port_list> : Port list or 'all', default: All ports

add : Add new port ARP inspection static entry

delete : Delete existing port ARP inspection static entry

<vid> : VLAN ID (1-4095)

<allowed_mac>: MAC address (xx-xx-xx-xx-xx-xx), MAC address allowed for doing ARP request

<allowed_ip> : IP address (a.b.c.d), IP address allowed for doing ARP request

Example:

Add ARP inspection static entry.

```
IGS-10020MT:/>security network arp inspection entry 1 add 1 00-30-4f-00-00-11 192.168.0.11
```

Security Network ARP Inspection Status

Description:

Show ARP inspection static and dynamic entries.

Syntax:

Security Network ARP Inspection Status [<port_list>]

Parameters:

<port_list>: Port list or 'all', default: All ports

Example:

Show ARP inspection static and dynamic entries.

```
IGS-10020MT:/>security network arp inspection status
```

Security AAA Configuration

Description:

Show Auth configuration.

Syntax:

Security AAA Configuration

Example:

Show Auth configuration.

```
IGS-10020MT:/>security aaa configuration
```

```
AAA Configuration:
```

```
=====
```

```
Server Timeout   : 15 seconds
```

```
Server Dead Time : 300 seconds
```

```
RADIUS Authentication Server Configuration:
```

```

=====
Server  Mode      IP Address      Secret          Port
-----  -
1      Disabled
2      Disabled
3      Disabled
4      Disabled
5      Disabled
1812
1812
1812
1812
1812

RADIUS Accounting Server Configuration:
=====
Server  Mode      IP Address      Secret          Port
-----  -
1      Disabled
2      Disabled
3      Disabled
4      Disabled
5      Disabled
1813
1813
1813
1813
1813

TACACS+ Authentication Server Configuration:
=====
Server  Mode      IP Address      Secret          Port
-----  -
1      Disabled
2      Disabled
3      Disabled
4      Disabled
5      Disabled
49
49
49
49
49

```

Security AAA Timeout

Description:

Set or show server timeout.

Syntax:

Security AAA Timeout [<timeout>]

Parameters:

<timeout>: Server response timeout (3-3600 seconds)
(default: Show server timeout configuration)

Default Setting:

15

Example:

Set 30sec for server timeout

```
IGS-10020MT:/>security aaa timeout 30
```

Security AAA Deadtime

Description:

Set or show server dead time.

Syntax:

Security AAA Deadtime [<dead_time>]

Parameters:

<dead_time>: Time that a server is considered dead if it doesn't answer a request (0-3600 seconds)
(default: Show server dead time configuration)

Default Setting:

300

Example:

Set 1000sec for server dead time

```
IGS-10020MT:/>security aaa deadtime 1000
```

Security AAA RADIUS

Description:

Set or show RADIUS authentication server setup.

Syntax:

Security AAA RADIUS [<server_index>] [enable|disable] [<ip_addr_string>] [<secret>] [<server_port>]

Parameters:

The server index (1-5)

(default: Show RADIUS authentication server configuration)

enable : Enable RADIUS authentication server

disable : Disable RADIUS authentication server

(default: Show RADIUS server mode)

<ip_addr_string>: IP host address (a.b.c.d) or a host name string

<secret> : Secret shared with external authentication server.

To set an empty secret, use two quotes ("").

To use spaces in secret, enquote the secret.

Quotes in the secret are not allowed.

<server_port> : Server UDP port. Use 0 to use the default RADIUS port (1812)

Example:

Set RADIUS authentication server configuration.

```
IGS-10020MT:/>security aaa radius 1 enable 192.168.0.20 12345678 1812
```

Security AAA ACCT_RADIUS**Description:**

Set or show RADIUS accounting server setup.

Syntax:

```
Security AAA ACCT_RADIUS [<server_index>] [enable|disable] [<ip_addr_string>] [<secret>] [<server_port>]
```

Parameters:

The server index (1-5)

(default: Show RADIUS accounting server configuration)

enable : Enable RADIUS accounting server

disable : Disable RADIUS accounting server

(default: Show RADIUS server mode)

<ip_addr_string>: IP host address (a.b.c.d) or a host name string

<secret> : Secret shared with external accounting server.

To set an empty secret, use two quotes ("").

To use spaces in secret, enquote the secret.

Quotes in the secret are not allowed.

<server_port> : Server UDP port. Use 0 to use the default RADIUS port (1813)

Example:

Set RADIUS accounting server configuration.

```
IGS-10020MT:/>security acct_radius 1 enable 192.168.0.20 12345678 1813
```

Security AAA TACACS+**Description:**

Set or show TACACS+ authentication server setup.

Syntax:

Security AAA TACACS+ [<server_index>] [enable|disable] [<ip_addr_string>] [<secret>] [<server_port>]

Parameters:

The server index (1-5)

(default: Show TACACS+ authentication server configuration)

enable : Enable TACACS+ authentication server

disable : Disable TACACS+ authentication server

(default: Show TACACS+ server mode)

<ip_addr_string>: IP host address (a.b.c.d) or a host name string

<secret> : Secret shared with external authentication server.

To set an empty secret, use two quotes ("").

To use spaces in secret, enquote the secret.

Quotes in the secret are not allowed.

<server_port> : Server TCP port. Use 0 to use the default TACACS+ port (49)

Example:

Set TACACS+ authentication server configuration.

```
IGS-10020MT:/>security aaa tacacs+ 1 enable 192.168.0.20 12345678 49
```

Security AAA Statistics**Description:**

Show RADIUS statistics.

Syntax:

Security AAA Statistics [<server_index>]

Parameters:

The server index (1-5)
 (default: Show statistics for all servers)

Example:

Show RADIUS statistics.

```
IGS-10020MT:/>security aaa statistics
```

6.8 Spanning Tree Protocol Command

STP Configuration

Description:

Show STP configuration.

Syntax:

STP Configuration

Example:

Show STP configuration.

```
IGS-10020MT:/>stp configuration
```

```
STP Configuration:
```

```
=====
```

```
Protocol Version: MSTP
```

```
Max Age          : 20
```

```
Forward Delay    : 15
```

```
Tx Hold Count    : 6
```

```
Max Hop Count    : 20
```

```
BPDU Filtering   : Disabled
```

```
BPDU Guard       : Disabled
```

```
Error Recovery   : Disabled
```

STP Version

Description:

Set or show the STP Bridge protocol version.

Syntax:

STP Version [<stp_version>]

Parameters:

<stp_version>: mstp|rstp|stp

Default Setting:

MSTP

Example:

Set the STP Bridge protocol version.

```
IGS-10020MT:/> stp version rstp
```

STP Tx Hold

Description:

Set or show the STP Bridge Transmit Hold Count parameter.

Syntax:

STP Txhold [<holdcount>]

Parameters:

<holdcount>: STP Transmit Hold Count (1-10)

Default Setting:

6

Example:

Set STP Tx hold in 10

```
IGS-10020MT:/>stp txhold 10
```

STP MaxHops

Description:

Set or show the MSTP Bridge Max Hop Count parameter.

Syntax:

STP MaxHops [<maxhops>]

Parameters:

<maxhops>: STP BPDU MaxHops (6-40))

Default Setting:

20

Example:

Set STP maximum hops in 25

```
IGS-10020MT:/>stp maxhops 25
```

STP MaxAge

Description:

Set or show the bridge instance maximum age.

Syntax:

STP MaxAge [<max_age>]

Parameters:

<max_age>: STP maximum age time (6-40, and max_age <= (forward_delay-1)*2)

Default Setting:

20

Example:

Set STP maximum age time in 10

```
IGS-10020MT:/>stp maxage 10
```

STP FwdDelay

Description:

Set or show the CIST/MSTI bridge forward delay.

Syntax:

STP FwdDelay [<delay>]

Parameters:

<delay>: MSTP forward delay (4-30, and max_age <= (forward_delay-1)*2))

Default Setting:

15

Example:

Set STP forward delay value in 25

```
IGS-10020MT:/>stp fwddelay 25
```

STP CName**Description:**

Set or Show MSTP configuration name and revision.

Syntax:

STP CName [<config-name>] [<integer>]

Parameters:

<config-name>: MSTP Configuration name. A text string up to 32 characters long.

Use quotes (") to embed spaces in name.

<integer> : Integer value

Default Setting:

Configuration name: MAC address

Configuration rev.: 0

Example:

Set MSTP configuration name and revision.

```
IGS-10020MT:/>stp cname 9f_IGS-10020MT 1
```

STP BPDU Filter**Description:**

Set or show edge port BPDU Filtering.

Syntax:

STP bpduFilter [enable|disable]

Parameters:

enable|disable: enable or disable BPDU Filtering for Edge ports

Default Setting:

Disable

Example:

Set edge port BPDU filtering

```
IGS-10020MT:/>stp bpdufilter enable
```

STP BPDU Guard

Description:

Set or show edge port BPDU Guard.

Syntax:

STP bpduGuard [enable|disable]

Parameters:

enable|disable: enable or disable BPDU Guard for Edge ports

Default Setting:

Disable

Example:

Set edge port BPDU guard

```
IGS-10020MT:/>stp bpduguard enable
```

STP Recovery

Description:

Set or show edge port error recovery timeout.

Syntax:

STP recovery [<timeout>]

Parameters:

<timeout>: Time before error-disabled ports are reenabled (30-86400 seconds, 0 disables)

(default: Show recovery timeout)

Default Setting:

Disable

Example:

Set STP recovery value in 30 sec.

```
IGS-10020MT:/>stp recovery 30
```

STP Status

Description:

Show STP Bridge status.

Syntax:

STP Status [<msti>] [<port_list>]

Parameters:

<msti> : STP bridge instance no (0-7, CIST=0, MSTI1=1, ...)

<port_list>: Port list or 'all', default: All ports

Default Setting:

Disable

Example:

Show STP Bridge status.

```
IGS-10020MT:/>stp status
CIST Bridge STP Status
Bridge ID   : 80:00-00:30:4F:24:04:D1
Root ID     : 80:00-00:30:4F:24:04:D1
Root Port   : -
Root PathCost: 0
Regional Root: 80:00-00:30:4F:24:04:D1
Int. PathCost: 0
Max Hops    : 20
TC Flag     : Steady
TC Count    : 0
TC Last     : -
Port        Port Role      State      Pri PathCost Edge P2P Uptime
-----
10          DesignatedPort Forwarding 128 20000 Yes Yes 0d 00:10:32
```

STP MSTI Priority

Description:

Set or show the bridge instance priority.

Syntax:

STP Msti Priority [<msti>] [<priority>]

Parameters:

<msti> : STP bridge instance no (0-7, CIST=0, MSTI1=1, ...)

<priority> : STP bridge priority (0/16/32/48/.../224/240)

Default:

128

Example:

Set MST1 priority value in 48.

```
IGS-10020MT:/>stp msti priority 1 48
```

STP MSTI Map

Description:

Show or clear MSTP MSTI VLAN mapping configuration.

Syntax:

STP Msti Map [<msti>] [clear]

Parameters:

<msti>: STP bridge instance no (0-7, CIST=0, MSTI1=1, ...)

Clear : Clear VID to MSTI mapping

Example:

Add MST1 priority value in 48.

```
IGS-10020MT:/>stp msti priority 1 48
```

STP MSTI Add

Description:

Add a VLAN to a MSTI.

Syntax:

STP Msti Add <msti> <vid>

Parameters:

<msti>: STP bridge instance no (0-7, CIST=0, MSTI1=1, ...)

<vid> : VLAN ID (1-4095)

Example:

Add MST1 in vlan1.

```
IGS-10020MT:/>stp msti add 1 1
```

STP Port Configuration

Description:

Show STP Port configuration.

Syntax:

STP Port Configuration [<port_list>]

Parameters:

<port_list>: Port list or 'all'. Port zero means aggregations.

Example:

Show STP status of Port1

```
IGS-10020MT:/>stp port configuration 1
```

Port	Mode	AdminEdge	AutoEdge	restrRole	restrTcn	Point2point
1	Disabled	Disabled	Enabled	Disabled	Disabled	Auto

STP Port Mode

Description:

Set or show the STP enabling for a port.

Syntax:

STP Port Mode [<port_list>] [enable|disable]

Parameters:

<port_list>: Port list or 'all'. Port zero means aggregations.

Enable : Enable MSTP protocol

Disable : Disable MSTP protocol

Default:

disable

Example:

Enable STP function on port1

```
IGS-10020MT:/>stp port mode 1 enable
```

STP Port Edge

Description:

Set or show the STP adminEdge port parameter.

Syntax:

STP Port Edge [<port_list>] [enable|disable]

Parameters:

<port_list>: Port list or 'all', default: All ports

Enable : Configure MSTP adminEdge to Edge

Disable : Configure MSTP adminEdge to Non-edge

Default:

disable

Example:

Enable STP edge function on port1

```
IGS-10020MT:/>stp port edge 1 enable
```

STP Port AutoEdge

Description:

Set or show the STP autoEdge port parameter.

Syntax:

STP Port AutoEdge [<port_list>] [enable|disable]

Parameters:

<port_list>: Port list or 'all', default: All ports

Enable : Enable MSTP autoEdge

Disable : Disable MSTP autoEdge

Default:

enable

Example:

Disable STP edge function on port1

```
IGS-10020MT:/>stp port autoedge 1 disable
```

STP Port P2P

Description:

Set or show the STP point2point port parameter.

Syntax:

STP Port P2P [<port_list>] [enable|disable|auto]

Parameters:

<port_list>: Port list or 'all', default: All ports

enable : Enable MSTP point2point

disable : Disable MSTP point2point

auto : Automatic MSTP point2point detection

Default:

auto

Example:

Disable STP P2P function on port1

```
IGS-10020MT:/>stp port p2p 1 disable
```

STP Port RestrictedRole

Description:

Set or show the MSTP restrictedRole port parameter.

Syntax:

STP Port RestrictedRole [<port_list>] [enable|disable]

Parameters:

<port_list>: Port list or 'all', default: All ports

enable : Enable MSTP restricted role

disable : Disable MSTP restricted role

Default:

disable

Example:

Enable STP restricted role on port1

```
IGS-10020MT:/>stp port restrictedrole 1 enable
```

STP Port RestrictedTcn

Description:

Set or show the MSTP restrictedTcn port parameter.

Syntax:

STP Port RestrictedTcn [<port_list>] [enable|disable]

Parameters:

<port_list>: Port list or 'all', default: All ports

enable : Enable MSTP restricted TCN

disable : Disable MSTP restricted TCN

Default:

disable

Example:

Enable STP restricted TCN on port1

```
IGS-10020MT:/>stp port restrictedtcn 1 enable
```

STP Port bpduGuard**Description:**

Set or show the bpduGuard port parameter.

Syntax:

STP Port bpduGuard [<port_list>] [enable|disable]

Parameters:

<port_list>: Port list or 'all', default: All ports

enable : Enable port BPDU Guard

disable : Disable port BPDU Guard

Default:

disable

Example:

Enable BPDU guard on port1

```
IGS-10020MT:/>stp port bpduguard 1 enable
```

STP Port Statistic**Description:**

Show STP port statistics.

Syntax:

STP Port Statistics [<port_list>] [clear]

Parameters:

<port_list>: Port list or 'all', default: All ports

clear : Clear the selected port statistics

Example:

Show STP port statistics.

```
IGS-10020MT:/>stp port statistics
Port      Rx MSTP  Tx MSTP  Rx RSTP  Tx RSTP  Rx STP  Tx STP  Rx TCN
Tx TCN   Rx III.  Rx Unk.
-----  -
```

STP Port Mcheck

Description:

Set the STP mCheck (Migration Check) variable for ports.

Syntax:

STP Port Mcheck [<port_list>]

Parameters:

<port_list>: Port list or 'all', default: All ports

Example:

Set the STP mCheck (Migration Check) variable for port 1.

```
IGS-10020MT:/>stp port mcheck 1
```

STP MSTI Port Configuration

Description:

Show the STP port instance configuration.

Syntax:

STP Msti Port Configuration [<msti>] [<port_list>]

Parameters:

<msti> : STP bridge instance no (0-7, CIST=0, MSTI1=1, ...)

<port_list>: Port list or 'all', default: All ports

Default:

auto

STP MSTI Port Cost**Description:**

Set or show the STP port instance path cost.

Syntax:

STP Msti Port Cost [<msti>] [<port_list>] [<path_cost>]

Parameters:

<msti> : STP bridge instance no (0-7, CIST=0, MSTI1=1, ...)

<port_list>: Port list or 'all'. Port zero means aggregations.

<path_cost>: STP port path cost (1-200000000) or 'auto'

Default:

auto

Example:

Set MSTI7 in port1

```
IGS-10020MT:/>stp msti port cost 7 1
```

MSTI	Port	Path Cost
MST7	1	Auto

STP MSTI Port Priority**Description:**

Set or show the STP port instance priority.

Syntax:

STP Msti Port Priority [<msti>] [<port_list>] [<priority>]

Parameters:

<msti> : STP bridge instance no (0-7, CIST=0, MST1=1, ...)

<port_list>: Port list or 'all'. Port zero means aggregations.

<priority> : STP port priority (0/16/32/48/.../224/240)

Default:

128

6.9 Link Aggregation Command

Aggregation Configuration

Description:

Show link aggregation configuration.

Syntax:

Aggr Configuration

Aggregation Add

Description:

Add or modify link aggregation.

Syntax:

Aggr Add <port_list> [<aggr_id>]

Parameters:

<port_list>: Port list or 'all', default: All ports

<aggr_id> : Aggregation ID

Example:

Add port 1~4 in Group1

```
IGS-10020MT:/>aggr add 1-4 1
```

Aggregation Delete

Description:

Delete link aggregation.

Syntax:

Aggr Delete <aggr_id>

Parameters:

<aggr_id>: Aggregation ID

Example:

Delete Group2

```
IGS-10020MT:/>aggr delete 2
```

Aggregation Lookup

Description:

Lookup link aggregation.

Syntax:

Aggr Lookup [<aggr_id>]

Parameters:

<aggr_id>: Aggregation ID

Aggregation Mode

Description:

Set or show the link aggregation traffic distribution mode.

Syntax:

Aggr Mode [smac|dmac|ip|port] [enable|disable]

Parameters:

smac : Source MAC address

dmac : Destination MAC address

ip : Source and destination IP address

port : Source and destination UDP/TCP port

enable : Enable field in traffic distribution

disable : Disable field in traffic distribution

Default Setting:

SMAC : Enabled

DMAC : Disabled

IP : Enabled

Port : Enabled

Example:

Disable SMAC mode

```
IGS-10020MT:/>Aggr mode smac disable
```

6.10 Link Aggregation Control Protocol Command

LACP Configuration

Description:

Show LACP configuration.

Syntax:

LACP Configuration [<port_list>]

Parameters:

<port_list>: Port list or 'all', default: All ports

Example:

Show LACP configuration

```
IGS-10020MT:/>lacp configuration
```

Port	Mode	Key	Role
1	Disabled	Auto	Active
2	Disabled	Auto	Active
3	Disabled	Auto	Active
4	Disabled	Auto	Active
5	Disabled	Auto	Active
6	Disabled	Auto	Active
7	Disabled	Auto	Active
8	Disabled	Auto	Active
9	Disabled	Auto	Active
10	Disabled	Auto	Active

LACP Mode

Description:

Set or show LACP mode.

Syntax:

LACP Mode [<port_list>] [enable|disable]

Parameters:

<port_list>: Port list or 'all', default: All ports

enable : Enable LACP protocol

disable: Disable LACP protocol

(default: Show LACP mode)

Default Setting:

disable

Example:

Enable LACP for port1~4

```
IGS-10020MT:/>lacp mode 1-4 enable
```

LACP Key

Description:

Set or show the LACP key.

Syntax:

LACP Key [<port_list>] [<key>]

Parameters:

<port_list>: Port list or 'all', default: All ports

<key> : LACP key (1-65535) or 'auto'

Default Setting:

auto

Example:

Set key1 for port1~4

```
IGS-10020MT:/>lacp key 1-4 1
```

LACP Role

Description:

Set or show the LACP role.

Syntax:

LACP Role [<port_list>] [active|passive]

Parameters:

<port_list>: Port list or 'all', default: All ports

active : Initiate LACP negotiation

passive: Listen for LACP packets

(default: Show LACP role)

Default Setting:

active

Example:

Set passive for port1~4

```
IGS-10020MT:/>lacp role 1-4 passive
```

LACP Status

Description:

Show LACP Status.

Syntax:

LACP Status [<port_list>]

Parameters:

<port_list>: Port list or 'all', default: All ports

Example:

Show LACP status of port1~4

```
IGS-10020MT:/>lacp status 1-4
```

Port	Mode	Key	Aggr ID	Partner System ID	Partner Port
----	-----	----	-----	-----	-----

1	Disabled	1	-	-	-
2	Disabled	1	-	-	-
3	Disabled	1	-	-	-
4	Disabled	1	-	-	-

LACP Statistics

Description:

Show LACP Statistics.

Syntax:

LACP Statistics [<port_list>] [clear]

Parameters:

<port_list>: Port list or 'all', default: All ports

clear : Clear LACP statistics

Example:

Show LACP statistics of port1~4

```
IGS-10020MT:/>lacp statistics 1-4
```

Port	Rx Frames	Tx Frames	Rx Unknown	Rx Illegal
-----	-----	-----	-----	-----
1	0	0	0	0
2	0	0	0	0
3	0	0	0	0
4	0	0	0	0

6.11 LLDP Command

LLDP Configuration

Description:

Show LLDP configuration.

Syntax:

LLDP Configuration [<port_list>]

Parameters:

<port_list>: Port list or 'all', default: All ports

Example:

Show LLDP configuration of port1~4

```
IGS-10020MT:/>lldp configuration 1-4

LLDP Configuration:
=====

Interval      : 30
Hold          : 3
Tx Delay      : 2
Reinit Delay: 2

Port Mode      Port Descr System Name System Descr System Capa Mgmt Addr CDP awareness
-----
1  Enabled  Enabled  Enabled  Enabled  Enabled  Enabled  Disabled
2  Enabled  Enabled  Enabled  Enabled  Enabled  Enabled  Disabled
3  Enabled  Enabled  Enabled  Enabled  Enabled  Enabled  Disabled
4  Enabled  Enabled  Enabled  Enabled  Enabled  Enabled  Disabled
```

LLDP Mode

Description:

Set or show LLDP mode.

Syntax:

LLDP Mode [<port_list>] [enable|disable|rx|tx]

Parameters:

<port_list>: Port list or 'all', default: All ports
enable : Enable LLDP reception and transmission
disable: Disable LLDP
rx : Enable LLDP reception only
tx : Enable LLDP transmission only
(default: Show LLDP mode)

Default Setting:

disable

Example:

Enable port1 LLDP function.

```
IGS-10020MT:/>lldp mode 1 enable
```

LLDP Optional TLV**Description:**

Show or Set LLDP Optional TLVs.

Syntax:

```
LLDP Optional_TLV [<port_list>] [port_descr|sys_name|sys_descr|sys_capa|mgmt_addr] [enable|disable]
```

Parameters:

<port_list>: Port list or 'all', default: All ports
port_descr : Description of the port
sysm_name : System name
sys_descr : Description of the system
sys_capa : System capabilities
mgmt_addr : Master's IP address
(default: Show optional TLV's configuration)
enable : Enables TLV
disable : Disable TLV
(default: Show optional TLV's configuration)

Default Setting:

Description of the port: Enable
System name: Enable
Description of the system: Enable

System capabilities: Enable
Master's IP address: Enable

Example:

Disable description of the port for port1

```
IGS-10020MT:/>lldp optional_tlv 1 port_descr disable
```

LLDP Interval

Description:

Set or show LLDP Tx interval.

Syntax:

LLDP Interval [<interval>]

Parameters:

<interval>: LLDP transmission interval (5-32768)

Default Setting:

30

Example:

Set transmission interval in 10

```
IGS-10020MT:/>lldp interval 10
```

LLDP Hold

Description:

Set or show LLDP Tx hold value.

Syntax:

LLDP Hold [<hold>]

Parameters:

<hold>: LLDP hold value (2-10)

Default Setting:

3

Example:

Set LLDP hold value in 10

```
IGS-10020MT:/>lldp hold 10
```

LLDP Delay

Description:

Set or show LLDP Tx delay.

Syntax:

LLDP Delay [<delay>]

Parameters:

<delay>: LLDP transmission delay (1-8192)

Default Setting:

2

Example:

Set LLDP delay value in 1

```
IGS-10020MT:/>lldp delay 1
```

LLDP Reinit

Description:

Set or show LLDP reinit delay.

Syntax:

LLDP Reinit [<reinit>]

Parameters:

<reinit>: LLDP reinit delay (1-10)

Default Setting:

2

Example:

Set LLDP reinit delay value in 3

```
IGS-10020MT:/>lldp reinit 3
```

LLDP Statistics

Description:

Show LLDP Statistics.

Syntax:

LLDP Statistics [<port_list>] [clear]

Parameters:

<port_list>: Port list or 'all', default: All ports

clear : Clear LLDP statistics

Example:

Show LLDP Statistics of port 1

```
IGS-10020MT:/>lldp statistics 1

LLDP global counters
Neighbor entries was last changed at - (18819 sec. ago).
Total Neighbors Entries Added 0.
Total Neighbors Entries Deleted 0.
Total Neighbors Entries Dropped 0.
Total Neighbors Entries Aged Out 0.

LLDP local counters
```

Port	Rx Frames	Tx Frames	Rx Errors	Rx Discards	Rx TLV Errors	Rx TLV Unknown	Rx TLV Organiz.	Rx TLV Aged
1	0	0	0	0	0	0	0	0

LLDP Info

Description:

Show LLDP neighbor device information.

Syntax:

LLDP Info [<port_list>]

Parameters:

<port_list>: Port list or 'all', default: All ports

6.12 LLDPMED Command

LLDPMED Configuration

Description:

Show LLDP-MED configuration.

Syntax:

LLDPMED Configuration [<port_list>]

Parameters:

<port_list>: Port list or 'all', default: All ports

Example:

Show LLDP-MED configuration of port1~4

```
IGS-10020MT:/>lldpmed configuration 1-4

LLDP-MED Configuration:
=====

Fast Start Repeat Count : 4
Location Coordinates   : Latitude           - 0.0000 North
                       : Longitude         - 0.0000 East
                       : Altitude           - 0.0000 meter(s)
                       : Map datum          - WGS84
Civic Address Location :

Port    Policies
1       none
2       none
3       none
4       none
```

LLDPMED Civic**Description:**

Set or show LLDP-MED Civic Address Location.

Syntax:

LLDPMED Civic

[country|state|county|city|district|block|street|leading_street_direction|trailing_street_suffix|str_suf|house_no|house_no_s
 uffix|landmark|additional_info|name|zip_code|building|apartment|floor|room_number|place_type|postal_com_name|p_o_
 box|additional_code] [<civic_value>]

Parameters:

country	: Country
state	: National subdivisions (state, caton, region, province, prefecture)
county	: County, parish,gun (JP), district(IN)
city	: City, townchip, shi (JP)
district	: City division,borough, city, district, ward,chou (JP)
block	: Neighborhood, block
street	: Street
leading_street_direction	: Leading street direction
trailing_street_suffix	: Trailing street suffix
str_suf	: Street Suffix
house_no	: House Number
house_no_suffix	: House number suffix
landmark	: Landmark or vanity address
additional_info	: Additional location information
name	: Bame(residence and office occupant)
zip_code	: Postal/zip code
building	: Building (structure)
apartment	: Unit (apartment, suite)
floor	: Floor
room_number	: Room number
place_type	: Placetype
postal_com_name	: Postal community name
p_o_box	: Post office box (P.O. Box)
additional_code	: Additional code

(default: Show Civic Address Location configuration)

<civic_value>: lldpmed The value for the Civic Address Location entry.

LLDPMED ECS

Description:

Set or show LLDP-MED Emergency Call Service.

Syntax:

LLDPMED ecs [<ecs_value>]

Parameters:

<ecs_value>: lldpmed The value for the Emergency Call Service

LLDPMED Policy Delete

Description:

Delete the selected policy.

Syntax:

LLDPMED policy delete [<policy_list>]

Parameters:

<policy_list>: List of policies to delete

Example:

Delete the policy 1

```
IGS-10020MT:/>lldpmed policy delete 1
```

LLDPMED Policy Add

Description:

Adds a policy to the list of policies.

Syntax:

```
LLDPMED policy add
[voice|voice_signaling|guest_voice|guest_voice_signaling|softphone_voice|video_conferencing|streaming_video|video_si
gnaling] [tagged|untagged] [<vlan_id>] [<l2_priority>] [<dscp>]
```

Parameters:

voice : Voice for use by dedicated IP Telephony handsets and other similar appliances supporting

interactive voice services. These devices are typically deployed on a separate VLAN for ease of deployment and enhanced security by isolation from data applications

- voice_signaling** : Voice Signaling (conditional) for use in network topologies that require a different policy for the voice signaling than for the voice media.
- guest_voice** : Guest Voice to support a separate limited feature-set voice service for guest users and visitors with their own IP Telephony handsets and other similar appliances supporting interactive voice services.
- guest_voice_signaling** : Guest Voice Signaling (conditional) for use in network topologies that require a different policy for the guest voice signaling than for the guest voice media.
- softphone_voice** : Softphone Voice for use by softphone applications on typical data centric devices, such as PCs or laptops. This class of endpoints frequently does not support multiple VLANs, if at all, and are typically configured to use an untagged VLAN or a single tagged data specific VLAN.
- video_conferencing** : Video Conferencing for use by dedicated Video Conferencing equipment and other similar appliances supporting real-time interactive video/audio services.
- streaming_video** : Streaming Video for use by broadcast or multicast based video content distribution and other similar applications supporting streaming video services that require specific network policy treatment. Video applications relying on TCP with buffering would not be an intended use of this application type.
- video_signaling** : Video Signaling (conditional) for use in network topologies that require a separate policy for the video signaling than for the video media.
- tagged** : The device is using tagged frames
- untagged** : The device is using untagged frames
- <vlan_id>** : VLAN id
- <l2_priority>**: This field may specify one of eight priority levels (0 through 7), as defined by IEEE 802.1D-2004 [3].
- <dscp>** : This field shall contain the DSCP value to be used to provide Diffserv node behavior for the specified application type as defined in IETF RFC 2474 [5]. This 6 bit field may contain one of 64 code point values (0 through 63). A value of 0 represents use of the default DSCP value as defined in RFC 2475.

LLDPMED Port Policy

Description:

Set or show LLDP-MED port policies.

Syntax:

LLDPMED port policies [<port_list>] [<policy_list>]

Parameters:

<port_list> : Port list or 'all', default: All ports

<policy_list>: List of policies to delete

LLDPMED Coordinates

Description:

Set or show LLDP-MED Location.

Syntax:

LLDPMED Coordinates [latitude|longitude|altitude] [north|south|west|east|meters|floor] [coordinate_value]

Parameters:

latitude : Latitude, 0 to 90 degree with max. 4 digits (Positive numbers are north of the equator and negative numbers are south of the equator).

longitude : Longitude, 0 to 180 degree with max. 4 digits (Positive values are East of the prime meridian and negative numbers are West of the prime meridian).

altitude : Altitude, Meters or floors with max. 4 digits.

(default: Show coordinate location configuration)

north|south|west|east|meters|floor:

North : North (Valid for latitude)

South : South (Valid for latitude)

West : West (Valid for longitude)

East : East (Valid for longitude)

Meters : Meters (Valid for altitude)

Floor : Floor (Valid for altitude)

lldpmed Coordinate value

coordinate_value : lldpmed Coordinate value

LLDPMED Datum

Description:

Set or show LLDP-MED Coordinates map datum.

Syntax:

LLDPMED Datum [wgs84|nad83_navd88|nad83_mllw]

Parameters:

wgs84|nad83_navd88|nad83_mllw:

wgs84 : WGS84

nad83_navd88 : NAD83_NAVD88

nad83_mllw : NAD83_MLLW

lldpmed Coordinate datum

LLDPMED Fast

Description:

Set or show LLDP-MED Fast Start Repeat Count.

Syntax:

LLDPMED Fast [<count>]

Parameters:

<count>: The number of times the fast start LLDPDU are being sent during the activation of the fast start mechanism defined by LLDP-MED (1-10).

LLDPMED Info

Description:

Show LLDP-MED neighbor device information.

Syntax:

LLDPMED Info [<port_list>]

Parameters:

<port_list>: Port list or 'all', default: All ports

6.13 EEE Command

EEE Configuration

Description:

Show eee configuration.

Syntax:

EEE Configuration [<port_list>]

Parameters:

<port_list>: Port list or 'all', default: All ports

Example:

Show EEE configuration of port1~4

```
IGS-10020MT:/>eee configuration 1-4

EEE Configuration:
=====

Port  Mode      Urgent queues
----  -
1     Disabled none
2     Disabled none
3     Disabled none
4     Disabled none
```

EEE Mode

Description:

Set or show the eee mode.

Syntax:

EEE Mode [<port_list>] [enable|disable]

Parameters:

<port_list>: Port list or 'all', default: All ports

enable : Enable EEE

disable: Disable EEE

(default: Show eee mode)

Default Setting:

Disabled

Example:

Enable EEE mode for port1~4

```
IGS-10020MT:/>eee mode enable 1-4
```

EEE Urgent Queues

Description:

Set or show EEE Urgent queues.

Syntax:

EEE Urgent_queues [<port_list>] [<queue_list>]

Parameters:

<port_list> : Port list or 'all', default: All ports

<queue_list>: List of queues to configure as urgent queues (1-8 or none)

Default Setting:

none

6.14 Thermal Command

Thermal Priority Temperature

Description:

Set or show the temperature at which the ports shall be shut down.

Syntax:

Thermal prio_temp [<prio_list>] [<shut_down_temp>]

Parameters:

<prio_list> : List of priorities (0-3)

<shut_down_temp>: Temperature at which ports shall be shut down (0-255 degree C)

Example:

Show thermal priority temperature.

```
IGS-10020MT:/> Thermal prio_temp

Priority  Temp.
-----  -
0         255 C
1         255 C
2         255 C
3         255 C
```

Thermal Port Priority

Description:

Set or show the ports priority.

Syntax:

Thermal port_prio [<port_list>] [<prio>]

Parameters:

<port_list>: Port list or 'all', default: All ports

<prio> : Priority (0-3)

Default Setting:

0

Example:

Set thermal port priority in 2

```
IGS-10020MT:/> Thermal port_prio 2
```

Thermal Status

Description:

Shows the chip temperature.

Syntax:

Thermal status

Example:

Shows the chip temperature.

```
IGS-10020MT:/> Thermal status
Port  Chip Temp.
-----
1     47 C
2     47 C
3     47 C
4     47 C
5     47 C
6     47 C
7     47 C
8     47 C
9     47 C
10    47 C
```

Thermal Configuration

Description:

Show thermal_protect configuration.

Syntax:

Thermal configuration

6.15 Quality of Service Command

QoS Configuration

Description:

Show QoS Configuration.

Syntax:

QoS Configuration [<port_list>]

Parameters:

<port_list>: Port list or 'all', default: All ports

QoS Port Classification Class

Description:

Set or show the default QoS class.

Syntax:

QoS Port Classification Class [<port_list>] [<class>]

Parameters:

<port_list>: Port list or 'all', default: All ports

<class> : QoS class (0-7)

Default Setting:

0

Example:

Set default QoS class in 1 for port 1

```
IGS-10020MT:/>qos Port Classification Class 1 1
```

QoS Port Classification DPL

Description:

Set or show the default Drop Precedence Level.

Syntax:

QoS Port Classification DPL [<port_list>] [<dpl>]

Parameters:

<port_list>: Port list or 'all', default: All ports

<dpl> : Drop Precedence Level (0-1)

Default Setting:

0

Example:

Set the default Drop Precedence Level in 1 for port1

```
IGS-10020MT:/>qos Port Classification dpl 1 1
```

QoS Port Classification PCP

Description:

Set or show the default PCP for an untagged frame.

Syntax:

QoS Port Classification PCP [<port_list>] [<pcp>]

Parameters:

<port_list>: Port list or 'all', default: All ports

<pcp> : Priority Code Point (0-7)

Default Setting:

0

Example:

Set the default PCP for an untagged frame in 1 for port1

```
IGS-10020MT:/>qos Port Classification pcp 1 1
```

QoS Port Classification DEI

Description:

Set or show the default DEI for an untagged frame.

Syntax:

QoS Port Classification DEI [<port_list>] [<dei>]

Parameters:

<port_list>: Port list or 'all', default: All ports

<dei> : Drop Eligible Indicator (0-1)

Default Setting:

0

Example:

Set the default DEI for an untagged frame in 1 for port1.

```
IGS-10020MT:/>qos Port Classification dei 1 1
```

QoS Port Classification Tag

Description:

Set or show if the classification is based on the PCP and DEI values in tagged frames.

Syntax:

QoS Port Classification Tag [<port_list>] [enable|disable]

Parameters:

<port_list>: Port list or 'all', default: All ports

enable : Enable tag classification

disable : Disable tag classification

(default: Show tag classification mode)

Default Setting:

disable

Example:

Enable QoS port classification Tag.

```
IGS-10020MT:/>qos Port Classification tag 1-10 enable
```

QoS Port Classification Map

Description:

Set or show the port classification map.

This map is used when port classification tag is enabled, and the purpose is to translate the Priority Code Point (PCP) and Drop Eligible Indicator (DEI) from a tagged frame to QoS class and DP level.

Syntax:

QoS Port Classification Map [<port_list>] [<pcp_list>] [<dei_list>] [<class>] [<dpl>]

Parameters:

<port_list>: Port list or 'all', default: All ports

<pcp_list>: PCP list or 'all', default: All PCPs (0-7)

<dei_list>: DEI list or 'all', default: All DEIs (0-1)

<class>: QoS class (0-7)

<dpl>: Drop Precedence Level (0-1)

QoS Port Classification DSCP

Description:

Set or show if the classification is based on DSCP value in IP frames.

Syntax:

QoS Port Classification DSCP [<port_list>] [enable|disable]

Parameters:

<port_list>: Port list or 'all', default: All ports

enable: Enable DSCP based classification

disable: Disable DSCP based classification

(default: Show DSCP based classification mode)

Default Setting:

disable

Example:

Enable QoS port classification DSCP.

```
IGS-10020MT:/>qos Port Classification dscp 1-10 enable
```

QoS Port Policer Mode

Description:

Set or show the port policer mode

Syntax:

QoS Port Policer Mode [<port_list>] [enable|disable]

Parameters:

<port_list>: Port list or 'all', default: All ports

enable : Enable port policer

disable : Disable port policer

(default: Show port policer mode)

Default Setting:

disable

Example:

Enable QoS port policer

```
IGS-10020MT:/>qos Port Policer Mode 1-10 enable
```

QoS Port Policer Rate

Description:

Set or show the port policer rate.

Syntax:

QoS Port Policer Rate [<port_list>] [<rate>]

Parameters:

<port_list>: Port list or 'all', default: All ports

<rate> : Rate in kbps or fps (100-15000000)

Default Setting:

500

Example:

Set the port policer rate in 1000

```
IGS-10020MT:/>qos Port Policer Rate 1-10 1000
```

QoS Port Policer Unit

Description:

Set or show the port policer unit.

Syntax:

QoS Port Policer Unit [<port_list>] [kbps|fps]

Parameters:

<port_list>: Port list or 'all', default: All ports

kbps : Unit is kilo bits per second

fps : Unit is frames per second

(default: Show port policer unit)

Default Setting:

kbps

Example:

Set the port policer unit in fps

```
IGS-10020MT:/>qos Port Policer unit 1-10 fps
```

QoS Port Scheduler Mode

Description:

Set or show the port scheduler mode.

Syntax:

QoS Port Scheduler Mode [<port_list>] [strict|weighted]

Parameters:

<port_list>: Port list or 'all', default: All ports

strict : Strict mode

weighted: Weighted mode

(default: Show port scheduler mode)

Default Setting:

strict

Example:

Set the port schedule mode in weighted mode

```
IGS-10020MT:/>qos Port Scheduler Mode 1-10 weighted
```

QoS Port Scheduler Weight**Description:**

Set or show the port scheduler weight.

Syntax:

QoS Port Scheduler Weight [<port_list>] [<queue_list>] [<weight>]

Parameters:

<port_list> : Port list or 'all', default: All ports

<queue_list>: Weighted queue list or 'all', default: All weighted queues (0-5)

<weight> : Scheduler weight (1-100)

QoS Port QueueShaper Mode**Description:**

Set or show the port queue shaper mode.

Syntax:

QoS Port QueueShaper Mode [<port_list>] [<queue_list>] [enable|disable]

Parameters:

<port_list> : Port list or 'all', default: All ports

<queue_list>: Queue list or 'all', default: All queues (0-7)

enable : Enable port queue shaper

disable : Disable port queue shaper

(default: Show port queue shaper mode)

Default Setting:

disable

Example:

Enable port queue shaper for all port & queue

```
IGS-10020MT:/>qos Port QueueShaper Mode 1-10 0-7 enable
```

QoS Port QueueShaper Rate

Description:

Set or show the port queue shaper rate.

Syntax:

QoS Port QueueShaper Rate [<port_list>] [<queue_list>] [<bit_rate>]

Parameters:

<port_list> : Port list or 'all', default: All ports

<queue_list>: Queue list or 'all', default: All queues (0-7)

<bit_rate> : Rate in kilo bits per second (100-3300000)

Default Setting:

500kbps

Example:

Set the port queue shaper rate in 1000

```
IGS-10020MT:/>qos Port QueueShaper rate 1-10 0-7 1000
```

QoS Port QueueShaper Excess

Description:

Set or show the port queue excess bandwidth mode.

Syntax:

QoS Port QueueShaper Excess [<port_list>] [<queue_list>] [enable|disable]

Parameters:

<port_list> : Port list or 'all', default: All ports

<queue_list>: Queue list or 'all', default: All queues (0-7)

enable : Enable use of excess bandwidth

disable : Disable use of excess bandwidth

(default: Show port queue excess bandwidth mode)

Default Setting:

disable

Example:

Enable the port queue excess bandwidth mode.

```
IGS-10020MT:/>qos Port QueueShaper Excess 1-10 0-7 enable
```

QoS Port Shaper Mode**Description:**

Set or show the port shaper mode.

Syntax:

QoS Port Shaper Mode [<port_list>] [enable|disable]

Parameters:

<port_list>: Port list or 'all', default: All ports

enable : Enable port shaper

disable : Disable port shaper

(default: Show port shaper mode)

Default Setting:

Enable

Example:

Enable port shaper mode.

```
IGS-10020MT:/>qos Port Shaper Mode 1-10 enable
```

QoS Port Shaper Rate**Description:**

Set or show the port shaper rate.

Syntax:

QoS Port Shaper Rate [<port_list>] [<bit_rate>]

Parameters:

<port_list>: Port list or 'all', default: All ports

<bit_rate> : Rate in kilo bits per second (100-3300000)

Default Setting:

500kbps

Example:

Set the port shaper rate in 1000.

```
IGS-10020MT:/>qos Port Shaper Rate 1-10 1000
```

QoS Port TagRemarking Mode**Description:**

Set or show the port tag remarking mode.

Syntax:

QoS Port TagRemarking Mode [<port_list>] [classified|default|mapped]

Parameters:**<port_list>**: Port list or 'all', default: All ports**classified**: Use classified PCP/DEI values**default** : Use default PCP/DEI values**mapped** : Use mapped versions of QoS class and DP level

(default: Show port tag remarking mode)

Default Setting:

classified

Example:

Set the port tag remarking mode in mapped.

```
IGS-10020MT:/>qos Port TagRemarking Mode 1-10 mapped
```

QoS Port TagRemarking PCP**Description:**

Set or show the default PCP. This value is used when port tag remarking mode is set to 'default'.

Syntax:

QoS Port TagRemarking PCP [<port_list>] [<pcp>]

Parameters:

<port_list>: Port list or 'all', default: All ports

<pcp> : Priority Code Point (0-7)

Default Setting:

0

Example:

Set the default PCP in 1.

```
IGS-10020MT:/>qos Port TagRemarking PCP 1-10 1
```

QoS Port TagRemarking DEI**Description:**

Set or show the default DEI. This value is used when port tag remarking mode is set to 'default'.

Syntax:

QoS Port TagRemarking DEI [<port_list>] [<dei>]

Parameters:

<port_list>: Port list or 'all', default: All ports

<dei> : Drop Eligible Indicator (0-1)

Default Setting:

0

Example:

Set the default EDI in 1.

```
IGS-10020MT:/>qos Port TagRemarking EDI 1-10 1
```

QoS Port TagRemarking Map**Description:**

Set or show the port tag remarking map. This map is used when port tag remarking mode is set to 'mapped', and the purpose is to translate the classified QoS class (0-7) and DP level (0-1) to PCP and DEI.

Syntax:

QoS Port TagRemarking Map [<port_list>] [<class_list>] [<dpl_list>] [<pcp>] [<dei>]

Parameters:

<port_list> : Port list or 'all', default: All ports
<class_list>: QoS class list or 'all', default: All QoS classes (0-7)
<dpl_list> : DP level list or 'all', default: All DP levels (0-1)
<pcp> : Priority Code Point (0-7)
<dei> : Drop Eligible Indicator (0-1)

QoS Port DSCP Translation**Description:**

Set or show DSCP ingress translation mode.

If translation is enabled for a port, incoming frame DSCP value is translated and translated value is used for QoS classification.

Syntax:

QoS Port DSCP Translation [<port_list>] [enable|disable]

Parameters:

<port_list>: Port list or 'all', default: All ports
enable : Enable DSCP ingress translation
disable : Disable DSCP ingress translation
 (default: Show DSCP ingress translation mode)

Default Setting:

disable

Example:

Enable DSCP ingress translation on all port.

```
IGS-10020MT:/>qos Port DSCP Translation 1-10 enable
```

QoS Port DSCP Classification

Description:

Set or show DSCP classification based on QoS class and DP level.

This enables per port to map new DSCP value based on QoS class and DP level.

Syntax:

QoS Port DSCP Classification [<port_list>] [none|zero|selected|all]

Parameters:

<port_list>: Port list or 'all', default: All ports

none : No DSCP ingress classification

zero : Classify DSCP if DSCP = 0

selected : Classify DSCP for which class. mode is 'enable'

all : Classify all DSCP

(default: Show port DSCP ingress classification mode)

Default Setting:

none

Example:

Set DSCP classification based on QoS class and DP level in zero

```
IGS-10020MT:/> QoS Port DSCP Classification 1-10 zero
```

QoS Port DSCP EgressRemark

Description:

Set or show the port DSCP remarking mode.

Syntax:

QoS Port DSCP EgressRemark [<port_list>] [disable|enable|remap_dp_unaware|remap_dp_aware]

Parameters:

<port_list>: Port list or 'all', default: All ports

disable : Disable DSCP egress rewrite

enable : Enable DSCP egress rewrite with the value received from analyzer

remap_dp_unaware : Rewrite DSCP in egress frame with remapped DSCP where remap is DP unaware or DP = 0

remap_dp_aware : Rewrite DSCP in egress frame with remapped DSCP where remap is DP aware and DP = 1

(default: Show port DSCP egress remarking mode)

Default Setting:

disable

Example:

Enable DSCP egress rewrite

```
IGS-10020MT:/> QoS Port DSCP EgressRemark 1-10 enable
```

QoS DSCP Map**Description:**

Set or show DSCP mapping table.

This table is used to map QoS class and DP level based on DSCP value.

DSCP value used to map QoS class and DPL is either translated DSCP value or incoming frame DSCP value.

Syntax:

QoS DSCP Map [<dscp_list>] [<class>] [<dpl>]

Parameters:**<dscp_list>**: DSCP (0-63, BE, CS1-CS7, EF or AF11-AF43) list or 'all'

(default: Show DSCP ingress map table i.e. DSCP->(class, DPL))

<class> : QoS class (0-7)**<dpl>** : Drop Precedence Level (0-1)**QoS DSCP Translation****Description:**

Set or show global ingress DSCP translation table.

If port DSCP translation is enabled, translation table is used to translate incoming frames DSCP value and translated value is used to map QoS class and DP level.

Syntax:

QoS DSCP Translation [<dscp_list>] [<trans_dscp>]

Parameters:**<dscp_list>** : DSCP (0-63, BE, CS1-CS7, EF or AF11-AF43) list or 'all'

(default: Show DSCP translation table)

<trans_dscp>: Translated DSCP: 0-63, BE, CS1-CS7, EF or AF11-AF43

QoS DSCP Trust

Description:

Set or show trusted DSCP value which is used for QoS classification.

The DSCP value to be checked for trust is either translated value if DSCP translation is enabled for the ingress port or incoming frame DSCP value if translation is disabled for the port. Trusted DSCP value is only used for QoS classification.

Syntax:

QoS DSCP Trust [<dscp_list>] [enable|disable]

Parameters:

<dscp_list>: DSCP (0-63, BE, CS1-CS7, EF or AF11-AF43) list or 'all'

enable : Set DSCP as trusted DSCP

disable : Set DSCP as un-trusted DSCP

(default: Show DSCP Trust status)

Default Setting:

disable

QoS DSCP Classification Mode

Description:

Set or show DSCP ingress classification mode.

If port DSCP classification is 'selected', DSCP will be classified based on QoS class and DP level only for DSCP value with classification mode 'enabled'. DSCP may be translated DSCP if translation is enabled for the port.

Syntax:

QoS DSCP Classification Mode [<dscp_list>] [enable|disable]

Parameters:

<dscp_list>: DSCP (0-63, BE, CS1-CS7, EF or AF11-AF43) list or 'all'

enable : Enable DSCP ingress classification

disable : Disable DSCP ingress classification

(default: Show DSCP classification mode)

Default Setting:

disable

QoS DSCP EgressRemap

Description:

Set or show DSCP egress remap table. This table is used if the port egress remarking mode is 'remap' and the purpose is to map the DSCP and DP level to a new DSCP value.

Syntax:

```
QoS DSCP EgressRemap [<dscp_list>] [<dpl_list>] [<dscp>]
```

Parameters:

<dscp_list>: DSCP (0-63, BE, CS1-CS7, EF or AF11-AF43) list or 'all'

<dpl_list>: DP level list or 'all', default: All DP levels (0-1)

<dscp>: Egress remapped DSCP: 0-63, BE, CS1-CS7, EF or AF11-AF43

QoS Storm Unicast

Description:

Set or show the unicast storm rate limiter.

Syntax:

```
QoS Storm Unicast [enable|disable] [<packet_rate>]
```

Parameters:

enable: Enable unicast storm control

disable: Disable unicast storm control

<packet_rate>: Rate in fps (1, 2, 4, ..., 512, 1k, 2k, 4k, ..., 32768k)

Default Setting:

disable

Example:

Enable unicast storm control in 2fps

```
IGS-10020MT:/> QoS Storm Unicast enable 2
```

QoS Storm Multicast

Description:

Set or show the multicast storm rate limiter.

Syntax:

QoS Storm Multicast [enable|disable] [<packet_rate>]

Parameters:

enable : Enable multicast storm control

disable : Disable multicast storm control

<packet_rate>: Rate in fps (1, 2, 4, ..., 512, 1k, 2k, 4k, ..., 32768k)

Default Setting:

disable

Example:

Enable multicast storm control in 2fps

```
IGS-10020MT:/> QoS Storm multicast enable 2
```

QoS QCL Add

Description:

Add or modify QoS Control Entry (QCE).

If the QCE ID parameter <qce_id> is specified and an entry with this QCE ID already exists, the QCE will be modified.

Otherwise, a new QCE will be added. If the QCE ID is not specified, the next available QCE ID will be used. If the next QCE ID parameter <qce_id_next> is specified, the QCE will be placed before this QCE in the list. If the next QCE ID is not specified and if it is a new entry added, the QCE will be placed last in the list. Otherwise if the next QCE ID is not specified and if existing QCE is modified, QCE will be in the same location in the list. To modify and move the entry to last in the list, use the word 'last' for <qce_id_next>.

Syntax:

QoS QCL Add [<qce_id>] [<qce_id_next>] [<port_list>] [<tag>] [<vid>] [<pcp>] [<dei>] [<smac>] [<dmac_type>] [(etype [<etype>]) | (LLC [<DSAP>] [<SSAP>] [<control>]) | (SNAP [<PID>]) | (ipv4 [<protocol>] [<sip>] [<dscp>] [<fragment>] [<sport>] [<dport>]) | (ipv6 [<protocol>] [<sip_v6>] [<dscp>] [<sport>] [<dport>])] [<class>] [<dp>] [<classified_dscp>]

Parameters:

<qce_id>	: QCE ID (1-256), default: Next available ID
<qce_id_next>	: Next QCE ID: "next_id (1-256) or 'last'"
<port_list>	: Port List: "port <port_list> or 'all'", default: All ports
<tag>	: Frame tag: untag tag any
<vid>	: VID: 1-4095 or 'any', either a specific VID or range of VIDs
<pcp>	: Priority Code Point: specific(0, 1, 2, 3, 4, 5, 6, 7) or range(0-1, 2-3, 4-5, 6-7, 0-3, 4-7) or 'any'
<dei>	: Drop Eligible Indicator: 0-1 or 'any'
<smac>	: Source MAC address: (xx-xx-xx) or 'any', 24 MS bits (OUI)
<dmac_type>	: Destination MAC type: unicast multicast broadcast any
etype	: Ethernet Type keyword
<etype>	: Ethernet Type: 0x600-0xFFFF or 'any' but excluding 0x800(IPv4) and 0x86DD(IPv6)
llc	: LLC keyword
<dsap>	: Destination Service Access Point: 0x00-0xFF or 'any'
<ssap>	: Source Service Access Point: 0x00-0xFF or 'any'
<control>	: LLC control: 0x00-0xFF or 'any'
snap	: SNAP keyword
<pid>	: Protocol ID (EtherType) or 'any'
ipv4	: IPv4 keyword
<protocol>	: IP protocol number: (0-255, TCP or UDP) or 'any'
<sip>	: Source IP address: (a.b.c.d/n) or 'any'
<dscp>	: DSCP:(0-63,BE,CS1-CS7,EF or AF11-AF43)or'any',specific/range
<fragment>	: IPv4 frame fragmented: yes no any
<sport>	: Source TCP/UDP port:(0-65535) or 'any',specific or port range
<dport>	: Dest. TCP/UDP port:(0-65535) or 'any', specific or port range
ipv6	: IPv6 keyword
<sip_v6>	: IPv6 source address: (a.b.c.d/n) or 'any', 32 LS bits
<class>	: QoS Class: "class (0-7)", default: basic classification
<dp>	: DP Level: "dp (0-1)", default: basic classification
<classified_dscp>	: DSCP: "dscp (0-63, BE, CS1-CS7, EF or AF11-AF43)"

QoS QCL Delete**Description:**

Delete QCE entry from QoS Control list.

Syntax:

QoS QCL Delete <qce_id>

Parameters:

<qce_id>: QCE ID (1-256), default: Next available ID

Default Setting:

disable

Example:

Enable multicast storm control in 2fps

```
IGS-10020MT:/> QoS Storm multicast enable 2
```

QoS QCL Lookup

Description:

Lookup QoS Control List.

Syntax:

QoS QCL Lookup [<qce_id>]

Parameters:

<qce_id>: QCE ID (1-256), default: Next available ID

Default Setting:

disable

Example:

Enable multicast storm control in 2fps

```
IGS-10020MT:/> QoS Storm multicast enable 2
```

QoS QCL Status

Description:

Show QCL status. This can be used to display if there is any conflict in QCE for different user types.

Syntax:

QoS QCL status [combined|static|voice_vlan|conflicts]

Parameters:

combined|static|voice_vlan|conflicts: combined : Shows the combined status
static : Shows the static user configured status
voice_vlan : Shows the status by Voice VLAN
conflicts : Shows all conflict status
(default : Shows the combined status)

QoS QCL Refresh**Description:**

Resolve QCE conflict status. Same H/W resource is shared by multiple applications and it may not be available even before MAX QCE entry. So user can release the resource in use by other applications and use this command to acquire the resource.

Syntax:

QoS QCL refresh

Parameters:

combined|static|voice_vlan|conflicts: combined : Shows the combined status
static : Shows the static user configured status
voice_vlan : Shows the status by Voice VLAN
conflicts : Shows all conflict status
(default : Shows the combined status)

Default Setting:

disable

Example:

Enable multicast storm control in 2fps

```
IGS-10020MT:/> QoS Storm multicast enable 2
```

6.16 Mirror Command

Mirror Configuration

Description:

Show mirror configuration.

Syntax:

Mirror Configuration [<port_list>]

Parameters:

<port_list>: Port list or 'all', default: All ports

Example:

Show mirror configuration.

```
IGS-10020MT:/>mirror configuration
```

Mirror Port

Description:

Set or show the mirror port.

Syntax:

Mirror Port [<port>|disable]

Parameters:

<port>|disable: Mirror port or 'disable', default: Show port

Default Setting:

disable

Example:

Set port 2 for the mirror port.

```
IGS-10020MT:/>mirror port 2
```

Mirror Mode

Description:

Set or show the mirror mode.

Syntax:

Mirror Mode [<port_list>] [enable|disable|rx|tx]

Parameters:

<port_list>: Port list or 'all', default: All ports

enable : Enable Rx and Tx mirroring

disable: Disable Mirroring

rx : Enable Rx mirroring

tx : Enable Tx mirroring

(default: Show mirror mode)

Default Setting:

disable

Example:

Enable the mirror mode for port 1-4.

```
IGS-10020MT:/>mirror mode 1-4 enable
```

6.17 Configuration Command

Configuration Save

Description:

Save configuration to TFTP server.

Syntax:

Config Save <ip_server> <file_name>

Parameters:

<ip_server>: TFTP server IP address (a.b.c.d)

<file_name>: Configuration file name

Configuration Load

Description:

Load configuration from TFTP server.

Syntax:

Config Load <ip_server> <file_name> [check]

Parameters:

<ip_server>: TFTP server IP address (a.b.c.d)

<file_name>: Configuration file name

check : Check configuration file only, default: Check and apply file

6.18 Firmware Command

Firmware Load

Description:

Load new firmware from TFTP server.

Syntax:

Firmware Load <ip_addr_string> <file_name>

Parameters:

<ip_addr_string>: IP host address (a.b.c.d) or a host name string

<file_name> : Firmware file name

Firmware IPv6 Load

Description:

Load new firmware from IPv6 TFTP server.

Syntax:

Firmware IPv6 Load <ipv6_server> <file_name>

Parameters:

<ipv6_server>: TFTP server IPv6 address

<file_name> : Firmware file name

Firmware Information

Description:

Display information about active and alternate firmware images.

Syntax:

Firmware Information

Firmware Swap

Description:

Activate the alternate firmware image..

Syntax:

Firmware Swap

6.19 UPnP Command

UPnP Configuration

Description:

Show UPnP configuration.

Syntax:

UPnP Configuration

Example:

Show UPnP configuration.

```
IGS-10020MT:/>upnp configuration

UPnP Configuration:
=====

UPnP Mode           : Disabled
UPnP TTL            : 4
UPnP Advertising Duration : 100
```

UPnP Mode

Description:

Set or show the UPnP mode.

Syntax:

UPnP Mode [enable|disable]

Parameters:

enable : Enable UPnP

disable: Disable UPnP

(default: Show UPnP mode)

Default Setting:

disable

Example:

Enable the UPnP mode.

```
IGS-10020MT:/>upnp mode enable
```

UPnP TTL

Description:

Set or show the TTL value of the IP header in SSDP messages.

Syntax:

UPnP TTL [<tll>]

Parameters:

<tll>: ttl range (1..255), default: Show UPnP TTL

Default Setting:

4

Example:

Set the value 10 for TTL value of the IP header in SSDP messages.

```
IGS-10020MT:/>upnp ttl 10
```

UPnP Advertising Duration

Description:

Set or show UPnP Advertising Duration.

Syntax:

UPnP Advertising Duration [<duration>]

Parameters:

<duration>: duration range (100..86400), default: Show UPnP duration range

Default Setting:

100

Example:

Set value 1000 for UPnP Advertising Duration.

```
IGS-10020MT:/>upnp advertising duration 1000
```

6.20 MVR Command

MVR Configuration

Description:

Show the MVR configuration.

Syntax:

MVR Configuration

Example:

Show the MVR configuration.

```
IGS-10020MT:/>mvr configuration

MVR Configuration:
=====

MVR Mode: Disabled
Muticast VLAN ID: 100

Port  Port Mode  Port Type  Immediate Leave
-----
1     Disabled    Receive    Disabled
2     Disabled    Receive    Disabled
3     Disabled    Receive    Disabled
4     Disabled    Receive    Disabled
5     Disabled    Receive    Disabled
6     Disabled    Receive    Disabled
7     Disabled    Receive    Disabled
8     Disabled    Receive    Disabled
9     Disabled    Receive    Disabled
10    Disabled    Receive    Disabled
```

MVR Group

Description:

Show the MVR group.

Syntax:

MVR Group

MVR Status

Description:

Show the MVR status.

Syntax:

MVR Status

MVR Mode

Description:

Set or show the MVR mode.

Syntax:

MVR Mode [enable|disable]

Parameters:

enable : Enable MVR mode

disable : Disable MVR mode

(default: Show MVR mode)

Default Setting:

disable

Example:

Enable MVR mode.

```
IGS-10020MT:/>mvr mode enable
```

MVR Port Mode

Description:

Set or show the MVR port mode.

Syntax:

MVR Port Mode [<port_list>] [enable|disable]

Parameters:

<port_list>: Port list or 'all', default: All ports

enable : Enable MVR mode

disable : Disable MVR mode

(default: Show MVR mode)

Default Setting:

disable

Example:

Enable the MVR port mode for port 1-4.

```
IGS-10020MT:/>mvr port mode 1-4 enable
```

MVR Multicast VLAN

Description:

Set or show MVR multicast VLAN ID.

Syntax:

MVR Multicast VLAN [<vid>]

Parameters:

<vid>: VLAN ID (1-4095), default: Show current MVR multicast VLAN ID

Default Setting:

100

Example:

Set VLAN 1000 for MVR multicast VLAN ID.

```
IGS-10020MT:/>mvr multicast vlan 1000
```

MVR Port Type

Description:

Set or show MVR port type.

Syntax:

MVR Port Type [<port_list>] [source|receiver]

Parameters:

<port_list>: Port list or 'all', default: All ports

source : Enable source mode

receiver : Disable receiver mode

(default: Show MVR port type)

Default Setting:

receive

Example:

Set source type for MVR port type of port 1.

```
IGS-10020MT:/>mvr port type 1 source
```

MVR Immediate Leave

Description:

Set or show MVR port state about immediate leave.

Syntax:

MVR Immediate Leave [<port_list>] [enable|disable]

Parameters:

<port_list>: Port list or 'all', default: All ports

enable : Enable Immediate-leave mode

disable : Disable Immediate-leave mode

(default: Show MVR Immediate-leave mode)

Default Setting:

disable

Example:

Enable MVR port state about immediate leave for port 1.

```
IGS-10020MT:/>mvr immediate leave 1 enable
```

6.21 Voice VLAN Command

Voice VLAN Configuration

Description:

Show Voice VLAN configuration.

Syntax:

Voice VLAN Configuration

Example:

Show Voice VLAN configuration.

```
IGS-10020MT:/>voice vlan configuration

V oice VLAN Configuration:
=====

Voice VLAN Mode           : Disabled
Voice VLAN VLAN ID       : 1000
Voice VLAN Age Time(seconds) : 86400
Voice VLAN Traffic Class  : 7

Voice VLAN OUI Table:
=====

Telephony OUI Description
-----
00-30-4F    PLANET phones
00-03-6B    Cisco phones
00-0F-E2    H3C phones
00-60-B9    Philips and NEC AG phones
00-D0-1E    Pingtel phones
00-E0-75    Polycom phones
00-E0-BB    3Com phones
```

```
00-01-E3      Siemens AG phones

Voice VLAN Port Configuration:
=====

Port  Mode      Security  Discovery Protocol
-----
1     Disabled  Disabled  OUI
2     Disabled  Disabled  OUI
3     Disabled  Disabled  OUI
4     Disabled  Disabled  OUI
5     Disabled  Disabled  OUI
6     Disabled  Disabled  OUI
7     Disabled  Disabled  OUI
8     Disabled  Disabled  OUI
9     Disabled  Disabled  OUI
10    Disabled  Disabled  OUI
```

Voice VLAN Mode

Description:

Set or show the Voice VLAN mode.
 We must disable MSTP feature before we enable Voice VLAN.
 It can avoid the conflict of ingress filter.

Syntax:

Voice VLAN Mode [enable|disable]

Parameters:

enable : Enable Voice VLAN mode.
disable: Disable Voice VLAN mode
 (default: Show flow Voice VLAN mode)

Default Setting:

disable

Example:

Enable the Voice VLAN mode.

```
IGS-10020MT:/>voice vlan mode enable
```

Voice VLAN ID

Description:

Set or show Voice VLAN ID.

Syntax:

Voice VLAN ID [<vid>]

Parameters:

<vid>: VLAN ID (1-4095)

Default Setting:

1000

Example:

Set ID 2 for Voice VLAN ID.

```
IGS-10020MT:/>voice vlan id 2
```

Voice VLAN Agetime

Description:

Set or show Voice VLAN age time.

Syntax:

Voice VLAN Agetime [<age_time>]

Parameters:

<age_time>: MAC address age time (10-10000000) default: Show age time

Default Setting:

86400sec

Example:

Set Voice VLAN age time in 100sec.

```
IGS-10020MT:/>voice valn agetime 100
```

Voice VLAN Traffic Class**Description:**

Set or show Voice VLAN ID.

Syntax:

Voice VLAN Traffic Class [<class>]

Parameters:

<class>: Traffic class (0-7)

Default Setting:

7

Example:

Set 4 traffic class for voice VLAN

```
IGS-10020MT:/>voice vlan traffic class4
```

Voice VLAN OUI Add**Description:**

Add Voice VLAN OUI entry.

Modify OUI table will restart auto detect OUI process. The maximum entry number is (16).

Syntax:

Voice VLAN OUI Add <oui_addr> [<description>]

Parameters:

<oui_addr> : OUI address (xx-xx-xx). The null OUI address isn't allowed

<description>: Entry description. Use 'clear' or "" to clear the string

No blank or space characters are permitted as part of a contact. (only in CLI)

Example:

Add Voice VLAN OUI entry.

```
IGS-10020MT:/>voice vlan oui add 00-11-22 test
```

Voice VLAN OUI Delete**Description:**

Delete Voice VLAN OUI entry.

Modify OUI table will restart auto detect OUI process.

Syntax:

Voice VLAN OUI Delete <oui_addr>

Parameters:

<oui_addr>: OUI address (xx-xx-xx). The null OUI address isn't allowed

Example:

Delete Voice VLAN OUI entry.

```
IGS-10020MT:/>voice vlan oui delete 00-11-22
```

Voice VLAN OUI Clear**Description:**

Clear Voice VLAN OUI entry.

Modify OUI table will restart auto detect OUI process.

Syntax:

Voice VLAN OUI Clear

Example:

Clear Voice VLAN OUI entry.

```
IGS-10020MT:/>voice vlan oui clear
```

Voice VLAN OUI Lookup

Description:

Clear Voice VLAN OUI entry. Modify OUI table will restart auto detect OUI process.

Syntax:

Voice VLAN OUI Clear

Example:

Lookup Voice VLAN OUI entry.

```
IGS-10020MT:/>voice vlan oui lookup
```

Voice VLAN Port Mode

Description:

Set or show the Voice VLAN port mode.

When the port mode isn't disabled, we must disable MSTP feature before we enable Voice VLAN. It can avoid the conflict of ingress filter.

Syntax:

Voice VLAN Port Mode [<port_list>] [disable|auto|force]

Parameters:

<port_list>: Port list or 'all', default: All ports

disable : Disjoin from Voice VLAN.

auto : Enable auto detect mode. It detects whether there is VoIP phone attached on the specific port and configure the Voice VLAN members automatically.

force : Forced join to Voice VLAN.

(default: Show Voice VLAN port mode)

Default Setting:

disable

Example:

Set auto mode for port 1-4 of Voice VLAN port mode.

```
IGS-10020MT:/>voice vlan port mode 1-4 auto
```

Voice VLAN Security

Description:

Set or show the Voice VLAN port security mode. When the function is enabled, all non-telephone MAC address in Voice VLAN will be blocked 10 seconds.

Syntax:

Voice VLAN Security [<port_list>] [enable|disable]

Parameters:

<port_list>: Port list or 'all', default: All ports

enable : Enable Voice VLAN security mode.

disable: Disable Voice VLAN security mode

(default: Show flow Voice VLAN security mode)

Default Setting:

disable

Example:

Enable the Voice VLAN port security mode for port 1-4.

```
IGS-10020MT:/>voice vlan security 1-4 enable
```

6.22 Loop Protect Command

Loop Protect Configuration

Description:

Show Loop Protection configuration.

Syntax:

Loop Protect Configuration

Loop Protect Mode

Description:

Set or show the Loop Protection mode.

Syntax:

Loop Protect Mode [enable|disable]

Parameters:

enable : Enable Loop Protection

disable: Disable Loop Protection

Default Setting:

enable

Loop Protect Transmit

Description:

Set or show the Loop Protection transmit interval.

Syntax:

Loop Protect Transmit [<transmit-time>]

Parameters:

Transmit time interval (1-10 seconds)

Default Setting:

5

Loop Protect Shutdown

Description:

Set or show the Loop Protection shutdown time.

Syntax:

Loop Protect Shutdown [<shutdown-time>]

Parameters:

Shutdown time interval (0-604800 seconds)

A value of zero disables re-enabling the port

Default Setting:

10

Loop Protect Port Configuration

Description:

Show Loop Protection port configuration.

Syntax:

Loop Protect Port Configuration [<port_list>]

Parameters:

<port_list>: Port list or 'all', default: All ports

Loop Protect Port Mode

Description:

Set or show the Loop Protection port mode.

Syntax:

Loop Protect Port Mode [<port_list>] [enable|disable]

Parameters:

<port_list>: Port list or 'all', default: All ports

enable : Enable Loop Protection

disable: Disable Loop Protection

Loop Protect Port Action

Description:

Set or show the Loop Protection port action.

Syntax:

Loop Protect Port Action [<port_list>] [shutdown|shut_log|log]

Parameters:

<port_list>: Port list or 'all', default: All ports

shutdown : Shutdown the port

shut_log : Shutdown the port and Log event

log : (Only) Log the event

6.23 IPMC Command

IPMC Configuration

Description:

Show IPMC snooping configuration.

Syntax:

IPMC Configuration [mld|igmp]

Parameters:

mld|igmp:

mld : IPMC for IPv6 MLD

igmp: IPMC for IPv4 IGMP

IPMC Mode

Description:

Set or show the IPMC snooping mode.

Syntax:

IPMC Mode [mld|igmp] [enable|disable]

Parameters:

mld|igmp:

mld : IPMC for IPv6 MLD

igmp: IPMC for IPv4 IGMP

enable : Enable IPMC snooping

disable: Disable IPMC snooping

(default: Show global IPMC snooping mode)

Default Setting:

disable

Example:

Enable IGMP snooping

```
IGS-10020MT:/>ipmc mode igmp enable
```

IPMC Flooding

Description:

Set or show the IPMC unregistered addresses flooding operation.

Syntax:

IPMC Flooding [mld|igmp] [enable|disable]

Parameters:**mld|igmp:**

mld : IPMC for IPv6 MLD

igmp: IPMC for IPv4 IGMP

enable : Enable IPMC flooding

disable: Disable IPMC flooding

(default: Show global IPMC flooding mode)

Default Setting:

enable

Example:

Enable IGMP flooding

```
IGS-10020MT:/>ipmc flooding igmp enable
```

IPMC Leave Proxy**Description:**

Set or show the mode of IPMC Leave Proxy.

Syntax:

IPMC Leave Proxy [mld|igmp] [enable|disable]

Parameters:**mld|igmp:**

mld : IPMC for IPv6 MLD

igmp: IPMC for IPv4 IGMP

enable : Enable IPMC Leave Proxy

disable: Disable IPMC Leave Proxy

(default: Show global IPMC Leave Proxy mode)

Default Setting:

disable

Example:

Enable IGMP Leave Proxy

```
IGS-10020MT:/>ipmc leave proxy igmp enable
```

IPMC Proxy

Description:

Set or show the mode of IPMC Proxy.

Syntax:

IPMC Proxy [mld|igmp] [enable|disable]

Parameters:

mld|igmp:

mld : IPMC for IPv6 MLD

igmp: IPMC for IPv4 IGMP

enable : Enable IPMC Proxy

disable: Disable IPMC Proxy

(default: Show global IPMC Proxy mode)

Default Setting:

disable

Example:

Enable IGMP Proxy

```
IGS-10020MT:/>ipmc proxy igmp enable
```

IPMC State

Description:

Set or show the IPMC snooping state for VLAN.

Syntax:

IPMC State [mld|igmp] [<vid>] [enable|disable]

Parameters:

mld|igmp:

mld : IPMC for IPv6 MLD

igmp: IPMC for IPv4 IGMP

<vid> : VLAN ID (1-4095) or 'any', default: Show all VLANs

enable : Enable MLD snooping

disable: Disable MLD snooping

Default Setting:

disable

Example:

Enable IGMP snooping state for VLAN 1

```
IGS-10020MT:/>ipmc state igmp 1 enable
```

IPMC Querier**Description:**

Set or show the IPMC snooping querier mode for VLAN.

Syntax:

IPMC Querier [mld|igmp] [<vid>] [enable|disable]

Parameters:**mld|igmp:****mld** : IPMC for IPv6 MLD**igmp**: IPMC for IPv4 IGMP**<vid>** : VLAN ID (1-4095) or 'any', default: Show all VLANs**enable** : Enable MLD querier**disable**: Disable MLD querier**Default Setting:**

disable

Example:

Enable IGMP querier for VLAN 1

```
IGS-10020MT:/>ipmc querier igmp 1 enable
```

IPMC Fastleave**Description:**

Set or show the IPMC snooping fast leave port mode.

Syntax:

IPMC Fastleave [mld|igmp] [<port_list>] [enable|disable]

Parameters:**mld|igmp:****mld** : IPMC for IPv6 MLD

igmp: IPMC for IPv4 IGMP

<port_list>: Port list or 'all', default: All ports

enable : Enable MLD fast leave

disable: Disable MLD fast leave

(default: Show IPMC fast leave mode)

Default Setting:

disable

Example:

Enable IGMP fast leave for all port

```
IGS-10020MT:/>ipmc fastleave igmp 1-10 enable
```

IPMC Throttling

Description:

Set or show the IPMC port throttling status.

Syntax:

IPMC Throttling [mld|igmp] [<port_list>] [limit_group_number]

Parameters:

mld|igmp :

mld : IPMC for IPv6 MLD

igmp: IPMC for IPv4 IGMP

<port_list>: Port list or 'all', default: All ports

0 : No limit

1~10 : Group learn limit

(default: Show IPMC Port Throttling)

Default Setting:

Unlimited

Example:

Set the max. learn 10 groups for ICMP port throttling

```
IGS-10020MT:/>ipmc throttling igmp 1-10 10
```

IPMC Filtering

Description:

Set or show the IPMC port group filtering list.

Syntax:

IPMC Filtering [mld|igmp] [<port_list>] [add|del] [group_addr]

Parameters:

mld|igmp :

mld : IPMC for IPv6 MLD

igmp: IPMC for IPv4 IGMP

<port_list>: Port list or 'all', default: All ports

add : Add new port group filtering entry

del : Del existing port group filtering entry

(default: Show IPMC port group filtering list)

group_addr : IPv4/IPv6 multicast group address, accordingly

IPMC Router

Description:

Set or show the IPMC snooping router port mode.

Syntax:

IPMC Router [mld|igmp] [<port_list>] [enable|disable]

Parameters:

mld|igmp :

mld : IPMC for IPv6 MLD

igmp: IPMC for IPv4 IGMP

<port_list>: Port list or 'all', default: All ports

enable : Enable IPMC router port

disable : Disable IPMC router port

(default: Show IPMC router port mode)

Example:

Enable port 1 in IPMC router port

```
IGS-10020MT:/>ipmc riuter igmp 1 enable
```

IPMC Status

Description:

Show IPMC operational status, accordingly.

Syntax:

```
IPMC Status [mld|igmp] [<vid>]
```

Parameters:

mld|igmp:

mld : IPMC for IPv6 MLD

igmp: IPMC for IPv4 IGMP

<vid> : VLAN ID (1-4095) or 'any', default: Show all VLANs

Example:

Show VLAN 1 IPMC operational status

```
IGS-10020MT:/>ipmc status igmp 1
```

IPMC Group

Description:

Show IPMC group addresses, accordingly.

Syntax:

```
IPMC Groups [mld|igmp] [<vid>]
```

Parameters:

mld|igmp:

mld : IPMC for IPv6 MLD

igmp: IPMC for IPv4 IGMP

<vid> : VLAN ID (1-4095) or 'any', default: Show all VLANs

Example:

Show VLAN 1 IPMC group addresses, accordingly.

```
IGS-10020MT:/>ipmc groups igmp 1
```

IPMC Version

Description:

Show IPMC Versions.

Syntax:

IPMC Version [mld|igmp] [<vid>]

Parameters:

mld|igmp:

mld : IPMC for IPv6 MLD

igmp: IPMC for IPv4 IGMP

<vid> : VLAN ID (1-4095) or 'any', default: Show all VLANs

Example:

Show VLAN 1 IPMC Versions.

```
IGS-10020MT:/>ipmc version igmp 1
```

IPMC SSM

Description:

Show SSM related information for IPMC.

Syntax:

IPMC SSM [mld|igmp] [<vid>] [<port_list>]

Parameters:

mld|igmp :

mld : IPMC for IPv6 MLD

igmp: IPMC for IPv4 IGMP

<vid> : VLAN ID (1-4095) or 'any', default: Show all VLANs

<port_list>: Port list or 'all', default: All ports

Example:

Show VLAN 1 & port 1-10 SSM related information for IPMC.

```
IGS-10020MT:/>ipmc ssm igmp 1 1-10
```

IPMC Parameter RV

Description:

Set or show the IPMC Robustness Variable.

Syntax:

IPMC Parameter RV [mld|igmp] [<vid>] [ipmc_param_rv]

Parameters:

mld|igmp :

mld : IPMC for IPv6 MLD

igmp: IPMC for IPv4 IGMP

<vid> : VLAN ID (1-4095) or 'any', default: Show all VLANs

ipmc_param_rv:

-1 : Default Value (2)

1~255 : Robustness Variable

(default: Show IPMC Interface Robustness Variable)

IPMC Parameter QI

Description:

Set or show the IPMC Query Interval.

Syntax:

IPMC Parameter QI [mld|igmp] [<vid>] [ipmc_param_qi]

Parameters:

mld|igmp :

mld : IPMC for IPv6 MLD

igmp: IPMC for IPv4 IGMP

<vid> : VLAN ID (1-4095) or 'any', default: Show all VLANs

ipmc_param_qi:

-1 : Default Value (125)

1~31744 : Query Interval in seconds

(default: Show IPMC Interface Query Interval)

IPMC Parameter QRI

Description:

Set or show the IPMC Query Response Interval.

Syntax:

IPMC Parameter QRI [mld|igmp] [<vid>] [ipmc_param_qri]

Parameters:

mld|igmp :

mld : IPMC for IPv6 MLD

igmp: IPMC for IPv4 IGMP

<vid> : VLAN ID (1-4095) or 'any', default: Show all VLANs

ipmc_param_qri:

-1 : Default Value (100)

0~31744 : Query Response Interval in tenths of seconds

(default: Show IPMC Interface Query Response Interval)

IPMC Parameter LLQI

Description:

Set or show the IPMC Last Listener Query Interval.

Syntax:

IPMC Parameter LLQI [mld|igmp] [<vid>] [ipmc_param_llqi]

Parameters:

mld|igmp :

mld : IPMC for IPv6 MLD

igmp: IPMC for IPv4 IGMP

<vid> : VLAN ID (1-4095) or 'any', default: Show all VLANs

ipmc_param_llqi:

-1 : Default Value (10)

0~31744 : Last Listener Query Interval in tenths of seconds

(default: Show IPMC Interface Last Listener Query Interval)

IPMC Parameter URI

Description:

Set or show the IPMC Unsolicited Report Interval.

Syntax:

IPMC Parameter URI [mld|igmp] [<vid>] [ipmc_param_uri]

Parameters:

mld|igmp :
mld : IPMC for IPv6 MLD
igmp: IPMC for IPv4 IGMP
<vid> : VLAN ID (1-4095) or 'any', default: Show all VLANs
ipmc_param_uri:
-1 : Default Value (1)
0~31744 : Unsolicited Report Interval in seconds
 (default: Show IPMC Interface Unsolicited Report Interval)

6.24 VLAN Control List Command

VCL MAC-based VLAN Configuration

Description:

Show VCL MAC-based VLAN configuration.

Syntax:

VCL Macvlan Configuration

VCL MAC-based VLAN Add

Description:

Add or modify VCL MAC-based VLAN entry.

Syntax:

VCL Macvlan Add <mac_addr> <vid> [<port_list>]

Parameters:

<mac_addr> : MAC address (xx-xx-xx-xx-xx-xx)
<vid> : VLAN ID (1-4095)
<port_list>: Port list or 'all', default: All ports

Example:

Add 00-11-22-33-44-55-66 in VLAN 20 for all port

```
IGS-10020MT:/>vcl macvlan add 00-11-22-33-44-55-66 20 1-10
```

VCL MAC-based VLAN Delete**Description:**

Delete VCL MAC-based VLAN entry.

Syntax:

VCL Macvlan Del <mac_addr>

Parameters:

<mac_addr> : MAC address (xx-xx-xx-xx-xx-xx)

Example:

Delete 00-11-22-33-44-55-66 in MAC-based VLAN list

```
IGS-10020MT:/> vcl macvlan del 00-11-22-33-44-55-66
```

VCL Status**Description:**

Show VCL MAC-based VLAN users configuration.

Syntax:

VCL Status [combined|static|nas|all]

Parameters:

combined|static|nas|all: VCL User

VCL Protocol-based VLAN Add Ethernet II**Description:**

Add VCL protocol-based VLAN Ethernet-II protocol to group mapping.

Syntax:

VCL ProtoVlan Protocol Add Eth2 <ether_type>|arp|ip|ipx|at <group_id>

Parameters:

<ether_type>|arp|ip|ipx|at: Ether Type (0x0600 - 0xFFFF)
 <group_id> : Protocol group ID

VCL Protocol-based VLAN Add SNAP**Description:**

Add VCL protocol-based VLAN SNAP protocol to group mapping.

Syntax:

VCL ProtoVlan Protocol Add Snap <oui>|rfc_1042|snap_8021h <pid> <group_id>

Parameters:

<oui>|rfc_1042|snap_8021h: OUI value (Hexadecimal 00-00-00 to FF-FF-FF).
 <pid> : PID value (0x0-0xFFFF). If OUI is 00-00-00, valid range of PID is from 0x0600-0xFFFF.
 <group_id> : Protocol group ID

VCL Protocol-based VLAN Add LLC**Description:**

Add VCL protocol-based VLAN LLC protocol to group mapping.

Syntax:

VCL ProtoVlan Protocol Add Llc <dsap> <ssap> <group_id>

Parameters:

<dsap> : DSAP value (0x00-0xFF)
 <ssap> : SSAP value (0x00-0xFF)
 <group_id>: Protocol group ID

VCL Protocol-based VLAN Delete Ethernet II**Description:**

Delete VCL protocol-based VLAN Ethernet-II protocol to group mapping.

Syntax:

VCL ProtoVlan Protocol Delete Eth2 <ether_type>|arp|ip|ipx|at

Parameters:

<ether_type>|arp|ip|ipx|at: Ether Type (0x0600 - 0xFFFF)

VCL Protocol-based VLAN Delete SNAP**Description:**

Delete VCL protocol-based VLAN SNAP protocol to group mapping.

Syntax:

VCL ProtoVlan Protocol Delete Snap <oui>|rfc_1042|snap_8021h <pid>

Parameters:

<oui>|rfc_1042|snap_8021h: OUI value (Hexadecimal 00-00-00 to FF-FF-FF).

<pid> : PID value (0x0-0xFFFF). If OUI is 00-00-00, valid range of PID is from 0x0600-0xFFFF.

VCL Protocol-based VLAN Delete LLC**Description:**

Delete VCL protocol-based VLAN LLC protocol to group mapping.

Syntax:

VCL ProtoVlan Protocol Delete Llc <dsap> <ssap>

Parameters:

<dsap>: DSAP value (0x00-0xFF)

<ssap>: SSAP value (0x00-0xFF)

VCL Protocol-based VLAN Add**Description:**

Add VCL protocol-based VLAN group to VLAN mapping.

Syntax:

VCL ProtoVlan Vlan Add [<port_list>] <group_id> <vid>

Parameters:

<port_list>: Port list or 'all', default: All ports

<group_id> : Protocol group ID

<vid> : VLAN ID (1-4095)

VCL Protocol-based VLAN Delete

Description:

Delete VCL protocol-based VLAN group to VLAN mapping.

Syntax:

VCL ProtoVlan Vlan Delete [<port_list>] <group_id>

Parameters:

<port_list>: Port list or 'all', default: All ports

<group_id> : Protocol group ID

VCL Protocol-based VLAN Configuration

Description:

Show VCL protocol-based VLAN entries.

Syntax:

VCL ProtoVlan Conf

6.25 SMTP Command

SMTP Configuration

Description:

Show SMTP configure.

Syntax:

SMTP Configuration

Default Setting:

disable

SMTP Mode

Description:

Enable or disable SMTP configure.

Syntax:

SMTP Mode [enable|disable]

Parameters:

enable : Enable SMTP mode

disable : Disable SMTP mode

(default: Show SMTP mode)

Default Setting:

disable

SMTP Server

Description:

Set or show SMTP server configure.

Syntax:

SMTP Server [<server>] [<port>]

Parameters:

<server>: SMTP server address

<port> : SMTP server port

Default Setting:

disable

SMTP Auth

Description:

Enable or disable SMTP authentication configure.

Syntax:

SMTP Auth [enable|disable]

Parameters:

enable : Enable SMTP Authentication

disable : Disable SMTP Authentication

(default: Show SMTP Authentication)

Default Setting:

disable

SMTP Auth_user

Description:

Set or show SMTP authentication user name configure.

Syntax:

SMTP Auth_user [<auth_user_text>]

Parameters:

<auth_user_text>: SMTP Authentication User Name

Default Setting:

disable

SMTP Auth_pass

Description:

Set or show SMTP authentication password configure.

Syntax:

SMTP Auth_pass [<auth_pass_text>]

Parameters:

<auth_pass_text>: SMTP Authentication Password

Default Setting:

disable

SMTP Mailfrom

Description:

Set or show SMTP e-mail from configure.

Syntax:

SMTP Mailfrom [<mailfrom_text>]

Parameters:

<mailfrom_text>: SMTP E-mail From address

Default Setting:

disable

SMTP Mailsubject

Description:

Set or show SMTP e-mail subject configure.

Syntax:

SMTP Mailsubject [<mailsubject_text>]

Parameters:

<mailsubject_text>: SMTP E-mail Subject

Default Setting:

disable

SMTP Mailto1

Description:

Set or show SMTP e-mail 1 to configure.

Syntax:

SMTP Mailto1 [<mailto1_text>]

Parameters:

<mailto1_text>: SMTP e-mail 1 to address

Default Setting:

disable

SMTP Mailto2

Description:

Set or show SMTP e-mail 2 to configure.

Syntax:

SMTP Mailto2 [<mailto2_text>]

Parameters:

<mailto1_text>: SMTP e-mail 2 to address

Default Setting:

disable

SMTP Test

Description:

Test the status for linking to SMTP server

Syntax:

SMTP Test

6.26 Ethernet Virtual Connections Command

EVC Configuration

Description:

Show EVC configuration.

Syntax:

EVC Configuration [<port_list>] [<policer_id>]

Parameters:

<port_list> : Port list or 'all', default: All ports

<policer_id>: Policer ID (1-128)

EVC Port DEI

Description:

Set or show port DEI mode.

Syntax:

EVC Port DEI [<port_list>] [<dei_mode>]

Parameters:

<port_list>: Port list or 'all', default: All ports

<dei_mode> : DEI mode: coloured|fixed

EVC Port Tag

Description:

Set or show port tag match mode.

Syntax:

EVC Port Tag [<port_list>] [<tag_mode>]

Parameters:

<port_list>: Port list or 'all', default: All ports

<tag_mode> : Tag mode: inner|outer

EVC Port Addr

Description:

Set or show port address match mode.

Syntax:

EVC Port Addr [<port_list>] [<addr_mode>]

Parameters:

<port_list>: Port list or 'all', default: All ports

<addr_mode>: IP/MAC address mode: source|destination

EVC Port L2CP

Description:

Set or show port L2CP mode

Syntax:

EVC Port L2CP [<port_list>] [<l2cp_list>] [<mode>]

Parameters:

<port_list>: Port list or 'all', default: All ports

<l2cp_list>: L2CP ID list (0-31). BPDU range: 0-15, GARP range: 16-31

<mode> : The mode takes the following values:

normal : Default forwarding

forward : Forward

redirect : Redirect to CPU

EVC Policer

Description:

Set or show EVC bandwidth profile.

Syntax:

EVC Policer [<policer_id>] [enable|disable] [<policer_mode>] [<cir>] [<cbs>] [<eir>] [<ebs>]

Parameters:

<policer_id> : Policer ID (1-128)

enable : Enable policer
disable : Disable policer
<policer_mode>: Policer_mode: coupled|aware
<cir> : Committed Information Rate [kbps]
<cbs> : Committed Burst Size [bytes]
<eir> : Excess Information Rate [kbps]
<ebs> : Excess Burst Size [bytes]

EVC Add

Description:

Add or modify EVC.

Syntax:

EVC Add <evc_id> [<vid>] [<ivid>] [<nni_list>] [<learning>] [inner] [<it_type>] [<it_vid_mode>] [<it_vid>] [<it_preserve>]
 [<it_pcp>] [<it_dei>] [outer] [<ot_vid>]

Parameters:

<evc_id> : EVC ID (1-128)
<vid> : EVC VLAN ID
<ivid> : Internal VLAN ID
<nni_list> : NNI port list (1-10) or 'none'
<learning> : Learning mode: enable|disable
inner : Inner tag action keyword
<it_type> : Inner tag type: none|c-tag|s-tag|s-custom-tag
<it_vid_mode>: Inner VID mode: normal|tunnel
<it_vid> : Inner tag VLAN ID (1-4095)
<it_preserve>: Inner tag preserved or fixed PCP/DEI: preserved|fixed
<it_pcp> : Inner tag PCP value (0-7)
<it_dei> : Inner tag DEI value (0-1)
outer : Outer tag action keyword
<ot_vid> : EVC outer tag VID for UNI ports

EVC Delete

Description:

Delete EVC.

Syntax:

EVC Delete <evc_id>

Parameters:

<evc_id>: EVC ID (1-128)

EVC Lookup

Description:

Lookup EVC.

Syntax:

EVC Lookup [<evc_id>]

Parameters:

<evc_id>: EVC ID (1-128)

EVC Status

Description:

Show EVC Status.

Syntax:

EVC Status [<evc_id>]

Parameters:

<evc_id>: EVC ID (1-128)

EVC Statistics

Description:

Show or clear EVC statistics.

Syntax:

EVC Statistics [<port_list>] [<class_list>] [<command>]

Parameters:

<port_list> : Port list or 'all', default: All ports

<class_list>: QoS class list, 0-7

<command> : Statistics command: clear|green|yellow|red|discard

EVC ECE Add

Description:

Add or modify EVC Control Entry (ECE):

- If <ece_id> is specified and the ECE exists, the ECE will be modified.
- If <ece_id> is omitted or the ECE does not exist, a new ECE will be added.
- If <ece_id_next> is specified, the ECE will be placed before this entry.
- If <ece_id_next> is 'last', the ECE will be placed at the end of the list.
- If <ece_id_next> is omitted and it is a new ECE, the ECE will be placed last.
- If <ece_id_next> is omitted and the ECE exists, the ECE will not be moved.

Syntax:

```
EVC ECE Add [<ece_id>] [<ece_id_next>] [uni] [<uni_list>] [<dmac_type>] [<smac>][tag] [<tag_type>] [<vid>] [<pcp>]
[<dei>] [all | (ipv4 [<proto>] [<sip>] [<dscp>] [<fragment>] [<sport>] [<dport>]) | (ipv6 [<proto>] [<sip_v6>] [<dscp>]
[<sport>] [<dport>])] [direction] [<direction>] [evc] [<evc_id>] [pop] [<pop>] [policy] [<policy>] [class] [<class>] [outer]
[<ot_mode>] [<ot_preserve>] [<ot_pcp>] [<ot_dei>]
```

Parameters:

<ece_id> : ECE ID (1-128)

<ece_id_next>: Next ECE ID (1-128) or 'last'

uni : UNI keyword

<uni_list> : UNI port list (1-10)

<dmac_type> : DMAC type: any|unicast|multicast|broadcast

<smac> : SMAC or 'any'

tag : Tag matching keyword

<tag_type> : Tag type: tagged|untagged|any

<vid> : VLAN ID value/range (0-4095) or 'any'

<pcp> : PCP value/range (0-7) or 'any'

<dei> : DEI value, 0, 1 or 'any'

all : Keyword for matching any frame type

ipv4 : Keyword for matching IPv4 frames

<proto> : IP protocol value (0-255) or 'any'

<sip> : IPv4 source address (a.b.c.d/n) or 'any'

<dscp> : DSCP value/range (0-63) or 'any'

<fragment> : IPv4 fragment: any|fragment|non-fragment

<sport>	: UDP/TCP source port value/range (0-65535) or 'any'
<dport>	: UDP/TCP destination port value/range (0-65535) or 'any'
ipv6	: Keyword for matching IPv6 frames
<sip_v6>	: IPv6 source address (a.b.c.d/n) or 'any'
direction	: Direction keyword
<direction>	: ECE direction: both uni-to-nni nni-to-uni
evc	: EVC keyword
<evc_id>	: EVC ID (1-128) or 'none'
pop	: Pop keyword
<pop>	: Tag pop count: 0 1 2
policy	: Policy keyword
<policy>	: ACL policy number (0-255)
class	: Class keyword
<class>	: QoS class, 'disable' or 0-7
outer	: Outer tag action keyword
<ot_mode>	: Outer tag for nni-to-uni direction: enable disable
<ot_preserve>	: Outer tag preserved or fixed PCP/DEI: preserved fixed
<ot_pcp>	: Outer tag PCP value (0-7)
<ot_dei>	: Outer tag DEI value (0-1)

EVC ECE Delete

Description:

Delete ECE.

Syntax:

EVC ECE Delete <ece_id>

Parameters:

<ece_id>: ECE ID (1-128)

EVC ECE Lookup

Description:

Lookup ECE.

Syntax:

EVC ECE Lookup [<ece_id>]

Parameters:

<ece_id>: ECE ID (1-128)

EVC ECE Status

Description:

Show ECE Status.

Syntax:

EVC ECE Status [<ece_id>]

Parameters:

<ece_id>: ECE ID (1-128)

6.27 Ethernet Protection Switching Command

EPS Create

Description:

EPS create.

Syntax:

```
EPS create [<inst>] [domport|dompath|domservice|dommpls] [1p1|1f1] [<flow_w>] [<flow_p>] [<mep_w>]
[<mep_p>][<mep_aps>] [enable|disable]
```

Parameters:

<inst>	: Instance number
domport dompath domservice dommpls	: Flow domain
1p1 1f1	: EPS architecture
<flow_w>	: Working flow instance number
<flow_p>	: Protecting flow instance number
<mep_w>	: Working MEP instance number
<mep_p>	: Protecting MEP instance number
<mep_aps>	: APS MEP instance number
enable disable	: enable/disable protection

EPS Config

Description:

EPS config operation.

Syntax:

```
EPS config [<inst>] [aps|noaps] [revert|norevert] [unidir|bidir]
[w0s|w10s|w30s|w1m|w5m|w12m][h0s|h100ms|h500ms|h1s|h2s|h5s|h10s]
```

Parameters:

<inst>	: Instance number
aps noaps	: APS enable/disable
revert norevert	: Revertive enable/disable

unidir|bidir : Unidirectional or bidirectional switching

w0s|w10s|w30s|w1m|w5m|w12m : Wait to restore timer value

h0s|h100ms|h500ms|h1s|h2s|h5s|h10s: Hold off timer value

EPS Command

Description:

EPS command set operation.

Syntax:

EPS command [<inst>] [clear|lockout|forced|manualp|manualw|exercise|freeze|lockoutlocal]

Parameters:

<inst> : Instance number

clear|lockout|forced|manualp|manualw|exercise|freeze|lockoutlocal: EPS protection command type - clear is 'no command active'

EPS State

Description:

Get protection state.

Syntax:

EPS state [<inst>]

Parameters:

<inst>: Instance number

6.28 Maintenance entity End Point Command

MEP Config

Description:

MEP instance configuration

'mep|mip' this entity is either a MEP or a MIP - end point or intermediate point

'ingress|egress' this entity is either a Ingress (down) or Egress (up) type of MEP/MIP

'domport|domevc' the domain is either Port or EVC

'level' is the MEG level

'port' is the residence port

'flow' is the related flow instance number - Port number in Port domain - EVC number in EVC domain

'vid' is used for TAGGED OAM in port domain

'itu|ieee' is the MEG ID format

'meg' is the MEG ID - max. 8 char in case of 'ieee' - 6 or 7 char in case of 'itu'

'mep' is the MEP ID.

Syntax:

```
MEP config [<inst>] [mep|mip] [ingress|egress] [<port>] [domport|domevc] [<level>] [itu|ieee] [<meg>] [<mep>] [<vid>]
[<flow>] [enable|disable]
```

Parameters:

<inst> : Instance number

mep|mip : Mode of the MEP instance

ingress|egress: Direction of the MEP instance

<port> : Port number.

domport|domevc: Flow domain

<level> : MEP level (0-7)

itu|ieee : MEG format

ITU: ICC format as defined in Y.1731 ANNEX A

IEEE: String format Domain Name and Short Name as defined in 802.1ag

<meg> : MEG ID (max. 8 chars)

<mep> : This MEP id (0-0x1FFF)

<vid> : C-TAG only applicable for Port MEP

<flow> : Flow instance number (Port/EVC)

enable|disable: enable/disable

MEP Peer MEP

Description:

MEP Peer MEP id configuration.

Syntax:

MEP peer MEP [<inst>] [<mep>] [<mac_addr>] [enable|disable]

Parameters:

<inst> : Instance number

<mep> : This MEP id (0-0x1FFF)

<mac_addr> : MAC address ('xx-xx-xx-xx-xx-xx' or 'xx.xx.xx.xx.xx.xx' or 'xxxxxxxxxxx', x is a hexadecimal digit)

enable|disable: enable/disable

MEP Continuity Check Configuration

Description:

MEP Continuity Check configuration

'prio' is the priority (PCP) of transmitted CCM frame

'300s|100s|10s|1s|6m|1m|6h' is the number of CCM frame pr. second.

Syntax:

MEP cc config [<inst>] [<prio>] [300s|100s|10s|1s|6m|1m|6h] [enable|disable]

Parameters:

<inst> : Instance number

<prio> : OAM PDU priority

300s|100s|10s|1s|6m|1m|6h: OAM period (100s -> 100 PDU pr. second)

enable|disable : enable/disable

MEP Loss Measurement Configuration

Description:

MEP Loss Measurement configuration

'prio' is the priority (PCP) of transmitted LM frame

'uni|multi' is selecting uni-cast or multi-cast transmission of LM frame

'single|dual' is selecting single-ended (LMM) or dual-ended (CCM) LM

'10s|1s|6m|1m|6h' is the number of LM frame pr. second

'flr' is the Frame Loss Ratio time interval.

Syntax:

```
MEP lm config [<inst>] [<prio>] [uni|multi] [single|dual] [10s|1s|6m|1m|6h] [<flr>] [enable|disable]
```

Parameters:

<inst> : Instance number
<prio> : OAM PDU priority
uni|multi : Destination address is unicast or multicast
single|dual : LM is single or dual ended
10s|1s|6m|1m|6h: LM period (10s -> 10 PDU pr. second)
<flr> : Frame loss ratio (in sec.)
enable|disable : enable/disable

MEP APS Configuration

Description:

MEP APS configuration

'prio' is the priority (PCP) of transmitted APS frame

'uni|multi' is selecting uni-cast or multi-cast transmission of APS frame

'laps|raps' is selecting ELPS or ERPS protocol

'octet' is the last octet in RAPS multicast MAC.

Syntax:

```
MEP aps config [<inst>] [<prio>] [uni|multi] [laps|raps] [<octet>] [enable|disable]
```

Parameters:

<inst> : Instance number
<prio> : OAM PDU priority
uni|multi : Destination address is unicast or multicast
laps|raps : Selection of Linear or Ring APS type
<octet> : The last octet in RAPS multicast MAC
enable|disable: enable/disable

MEP Client Configuration

Description:

MEP Client configuration

'domport|domevc' is the client domain - must be EVC

'level' is the client MEG level - the contained level in the AIS and LCK frames

'cflow' is the client flow instance - up to 10 possible client flows (EVC).

Syntax:

MEP client config [<inst>] [domport|domevc] [<level>] [<cflow>] [<cflow>] [<cflow>] [<cflow>] [<cflow>] [<cflow>] [<cflow>] [<cflow>] [<cflow>]

Parameters:

- <inst> : Instance number
- domport|domevc: Flow domain
- <level> : MEP level (0-7)
- <cflow> : Client flow instance number (EVC)

MEP AIS Configuration

Description:

MEP AIS configuration

'prio' is the priority (PCP) of transmitted AIS frame

'1s|1m' is the number of AIS frame pr. second

'set|clear' is set or clear of protection usability. If set, the first 3 AIS frames are transmitted as fast as possible - this gives protection reliability in the path end-point.

Syntax:

MEP ais config [<inst>] [<prio>] [1s|1m] [set|clear] [enable|disable]

Parameters:

- <inst> : Instance number
- <prio> : OAM PDU priority
- 1s|1m : Transmit period for AIS
 - 1s - to send OAM Frames in the rate of 1 per second
 - 1m - to send OAM frames in the rate of 1 per minute
- set|clear : Protection usability set/clear
- enable|disable: enable/disable

MEP LCK Configuration

Description:

MEP LCK configuration

'prio' is the priority (PCP) of transmitted AIS frame

'1s|1m' is the number of AIS frame pr. second.

Syntax:

MEP lck config [<inst>] [<prio>] [1s|1m] [enable|disable]

Parameters:

<inst> : Instance number

<prio> : OAM PDU priority

1s|1m : Transmit period for LCK

1s - to send OAM Frames in the rate of 1 per second

1m - to send OAM frames in the rate of 1 per minute

enable|disable: enable/disable

MEP Link Trace Configuration

Description:

MEP Link Trace configuration

'prio' is the priority (PCP) of transmitted LTM frame

'mac_addr' is the unicast MAC of target MEP/MIP

'mep' is the peer MEP-ID of target MEP - only used if 'mac_addr' is 'all zero'

'ttl' is the TLL in the transmitted LTM.

Syntax:

MEP lt config [<inst>] [<prio>] [<mac_addr>] [<mep>] [<ttl>] [enable|disable]

Parameters:

<inst> : Instance number

<prio> : OAM PDU priority

<mac_addr> : MAC address ('xx-xx-xx-xx-xx-xx' or 'xx.xx.xx.xx.xx.xx' or 'xxxxxxxxxx', x is a hexadecimal digit)

<mep> : This MEP id (0-0x1FFF)

<ttl> : LT - Time To Live

enable|disable: enable/disable

MEP Loop Back Configuration

Description:

MEP Loop Back configuration

'set|clear' is set or clear of DEI of transmitted LBM frame

'prio' is the priority (PCP) of transmitted LBM frame

'uni|multi' is selecting uni-cast or multi-cast transmission of LBM frame

'mac_addr' is the unicast MAC of target MEP/MIP

'mep' is the peer MEP-ID of target MEP - only used if 'mac_addr' is 'all zero'

'tosend' is the number of LBM to send

'size' is the size of the LBM data field

'gap' is the gap between LBM.

Syntax:

MEP lb config [<inst>] [set|clear] [<prio>] [uni|multi] [<mac_addr>] [<mep>] [<tosend>] [<size>] [<gap>] [enable|disable]

Parameters:

<inst> : Instance number

set|clear : OAM DEI set/clear

<prio> : OAM PDU priority

uni|multi : Destination address is unicast or multicast

<mac_addr> : MAC address ('xx-xx-xx-xx-xx-xx' or 'xx.xx.xx.xx.xx.xx' or 'xxxxxxxxxx', x is a hexadecimal digit)

<mep> : This MEP id (0-0x1FFF)

<tosend> : Number of LBM to send

<size> : Size of LBM data field in bytes (max 1400)

<gap> : Gap between LBM to send in 10ms. (max 100 - '0' is as fast as possible)

enable|disable: enable/disable

MEP Delay Measurement Configuration

Description:

MEP Delay Measurement configuration

'prio' is the priority (PCP) of transmitted DM frame

'uni|multi' is selecting uni-cast or multi-cast transmission of DM frame

'mep' is the peer MEP-ID of target MEP - only used if 'uni'

'oneway|twoway' is selecting one-way (1DM) or two-way (DMM) DM

'std|prop' is selecting standardized or proprietary DM. the latest is using off-standard follow-up message carrying the exact HW transmit timestamp

'rdtrp|flow' is selecting round-trip or flow delay calculation. Round-trip is not using the far-end timestamps to calculate the far-end residence time

'gap' Gap between transmitting 1DM/DMM PDU - in 10 ms.

'count' number of frames used for average calculation on the latest 'count' frames received

'us|ns' calculation results are shown in micro or nano seconds

'keep|reset' the action in case of total delay counter overflow - either 'keep' all results or 'reset' all results

'd2ford1' this is selecting to used two-way DMM for calculate one-way delay.

Syntax:

```
MEP dm config [<inst>] [<prio>] [uni|multi] [<mep>] [oneway|twoway] [std|prop] [rdtrp|flow] [<gap>] [<count>] [us|ns]
[keep|reset] [d2ford1] [enable|disable]
```

Parameters:

<inst> : Instance number

<prio> : OAM PDU priority

uni|multi : Destination address is unicast or multicast

<mep> : This MEP id (0-0x1FFF)

oneway|twoway : DM is one-way or two-way

std|prop : Standard or Vitesse proprietary way(w/ follow-up packets) to send DM

rdtrp|flow : 2/4 timestamps selection

<gap> : Gap between 1DM/DMM to send in 10ms(10-65535).

<count> : The number of last records to calculate(10 - 2000)

us|ns : Time resolution

keep|reset : The action to counter when overflow happens

d2ford1 : Enable to use DMM/DMR packets to calculate one-way DM

enable|disable: enable/disable

MEP Test Signal Configuration

Description:

MEP Test Signal configuration

'set|clear' is set or clear of DEI of transmitted LBM frame

'prio' is the priority (PCP) of transmitted TST frame

'mep' is the peer MEP-ID of target MEP - only used if 'mac_addr' is 'all zero'

'no_seq|seq' is without and with transmitted sequence numbers

'rate' is the TST frame transmission bit rate in Mbps'

'size' is the size of the un-tagged TST frame - four bytes will be added for each tag

'allzero|allone|onezero' is pattern contained in the TST frame data TLV.

Syntax:

```
MEP tst config [<inst>] [set|clear] [<prio>] [<mep>] [no_seq|seq] [<rate>] [<size>] [allzero|allone|onezero] [enable|disable]
```

Parameters:

<inst> : Instance number
set|clear : OAM DEI set/clear
<prio> : OAM PDU priority
<mep> : This MEP id (0-0x1FFF)
no_seq|seq : TST sequence number transmission
<rate> : Transmission bit rate of TST frames - in Mbps
<size> : Size of TST data field in bytes (max 1518)
allzero|allone|onezero: Data pattern to be filled in TST PDU
enable|disable : enable/disable

MEP State

Description:

MEP state get.

Syntax:

MEP state [<inst>]

Parameters:

<inst> : Instance number

MEP Loss Measurement State

Description:

MEP Loss Measurement state get.

Syntax:

MEP lm state [<inst>]

Parameters:

<inst> : Instance number

MEP Loss Measurement State Clear

Description:

MEP Loss Measurement state clear

Syntax:

MEP lm clear <inst>

Parameters:

<inst> : Instance number

MEP Link Trace State

Description:

MEP Link Trace state get.

Syntax:

MEP lt state [<inst>]

Parameters:

<inst> : Instance number

MEP Loop Back State

Description:

MEP Loop Back state get.

Syntax:

MEP lb state [<inst>]

Parameters:

<inst> : Instance number

MEP Delay Measurement State

Description:

MEP Delay Measurement state get.

Syntax:

MEP dm state [<inst>]

Parameters:

<inst> : Instance number

MEP Delay Measurement State Clear

Description:

MEP Delay Measurement state clear

Syntax:

MEP dm clear <inst>

Parameters:

<inst> : Instance number

MEP Test Signal State

Description:

MEP Test Signal state get

RX rate is shown in 100 Kbps.

Syntax:

MEP tst state [<inst>]

Parameters:

<inst> : Instance number

MEP Test Signal State Clear

Description:

MEP Test Signal state clear

Syntax:

MEP tst clear <inst>

Parameters:

<inst> : Instance number

6.29 Ethernet Ring Protection Switching Command

ERPS Command

Description:

Invoking an administrative command for a given protection group

[fs|ms|clear] : setting or clearing an administrative command for a given group

<port> : forced a block on the ring port where this command is issued

<group_id> : protection group id

Syntax:

Erps command [fs|ms|clear] <port> <group-id>

Parameters:

fs|ms|clear: administrative commands

<port> : Port number

<group-id> : protection group id 1 - 64

ERPS Version

Description:

Specifying protocol version for a given protection group

[v1|v2] : specifying protocol version for a given protection group

<group_id> : protection group id

Syntax:

Erps version [v1|v2] <group-id>

Parameters:

v1|v2 : ERPS protocol version to be supported

<group-id>: protection group id 1 - 64

ERPS Add

Description:

create a new ethernet ring protection group

<group-id> : protection group id

<east_port> : protection group Port 0
 <west_port> : protection group Port 1, Port 1 can be 0 for sub-rings
 [major|sub] : ring type i.e major-ring or sub-ring
 [interconnected] : interconnection node or not
 [[virtual_channel] : Virtual channel present or not
 [<major-ring-id>] : major ring group Id for interconnected sub-ring

Syntax:

Erps add <group-id> <east_port> <west_port> [major|sub] [interconnected] [virtual_channel] [<major-ring-id>]

Parameters:

<group-id> : protection group id 1 - 64
<east_port> : Port 0 of a protection group
<west_port> : Port 1 of a protection group
major|sub : ring type
interconnected : Set for interconnected node
virtual_channel: Set for virtual channel
<major-ring-id>: major ring of a sub-ring, when configuring as an interconnected node

ERPS Reversion

Description:

Configuring reversion characteristics for a given node
 [revertive|nonrevertive] : enabling or disabling reversion for a given group
 <group_id> : protection group id

Syntax:

Erps reversion [revertive|nonrevertive] <group-id>

Parameters:

revertive|nonrevertive: specifying reversion parameters
<group-id> : protection group id 1 - 64

ERPS VLAN Add

Description:

Associating a given vlan to a protection group
 <vid> : vlan to be protected

<group-id> : protection group-id for which vid belongs to.

Syntax:

Erps vlan add <vid> <group-id>

Parameters:

<vid> : VLAN ID (1-4095)

<group-id>: protection group id 1 - 64

ERPS VLAN Delete**Description:**

Disassociating a given vlan to a protection group

<vid> : protected vlan to be deleted

<group-id> : protection group-id for which vid belongs to.

Syntax:

Erps vlan delete <vid> <group-id>

Parameters:

<vid> : VLAN ID (1-4095)

<group-id>: protection group id 1 - 64

ERPS MEP**Description:**

Associating Port 0/1 MEP to a protection group

<east_sf_mep> : Mep_ID for finding out Continuity Check errors on Port 0

<west_sf_mep> : Mep_ID for finding out Continuity Check errors on Port 1

<east_raps_mep> : Mep_ID for transmitting R-APS frames on Port 0

<west_raps_mep> : Mep_ID for transmitting R-APS frames on Port 1

<group_id> : protection group id for which mep is associating.

Syntax:

Erps mep <east_sf_mep> <west_sf_mep> <east_raps_mep> <west_raps_mep> <group-id>

Parameters:

<east_sf_mep> : SF mep id for Port 0

<west_sf_mep> : SF mep id for Port 1
<east_raps_mep>: CC/RAPS mep id for Port 0
<west_raps_mep>: CC/RAPS mep id for Port 1
<group-id> : protection group id 1 - 64

ERPS RPL Neighbour

Description:

Selection of RPL neighbour for a protection group
(east|west) : selected east(Port 0) or west(Port 1) as RPL neighbour
<group-id> : protection group id for selecting RPL Block.

Syntax:

Erps rpl neighbour <rpl_port> <group-id>

Parameters:

<rpl_port>: RPL Block
<group-id>: protection group id 1 - 64

ERPS RPL Owner

Description:

Selection of RPL Block for a protection group
by default this node is considered as RPL Owner
(east|west) : select east(Port 0) or west(Port 1) as RPL Block
<group-id> : protection group id for selecting RPL Block.

Syntax:

Erps rpl owner <rpl_port> <group-id>

Parameters:

<rpl_port>: RPL Block
<group-id>: protection group id 1 - 64

ERPS RPL Neighbour Clear

Description:

make this node as non-neighbour for a protection group
<group-id> : protection group id for selecting RPL Block.

Syntax:

```
Erps rpl neighbour clear <group-id>
```

Parameters:

<group-id>: protection group id 1 - 64

ERPS RPL Owner Clear

Description:

making a node as Non-RPL Block for a protection group
After clear, this node is nore an rpl owner for the given group
(east|west) : selected east(Port 0) or west(Port 1) as RPL Block
<group-id> : protection group id for selecting RPL Block.

Syntax:

```
Erps rpl owner clear <group-id>
```

Parameters:

<group-id>: protection group id 1 - 64

ERPS Hold Off Timeout

Description:

configuring hold off timeout for a protection group
in milliseconds 0-10000 in the increments of 100ms
<hold_timeout> : hold-off timeout
<group-id> : protection group id for configuring hold-off time.

Syntax:

```
Erps hold off timeout <hold_timeout> <group-id>
```

Parameters:

<hold_timeout>: timer timeout values

<group-id> : protection group id 1 - 64

ERPS Guard-timeout

Description:

configuring guard timeout for a protection group

guard timeout should be configured in the increments of 10 milliseconds

minimum guard timeout 10ms and maximum 2 seconds

<guard_timeout> : guard timeout

<group-id> : protection group id for configuring guard time.

Syntax:

Erps guard-timeout <guard_timeout> <group-id>

Parameters:

<guard_timeout>: timer timeout values

<group-id> : protection group id 1 - 64

ERPS WRT-timeout

Description:

configuring wait to restore timeout for a protection group

in minutes in the range of 1 to 12 minutes

<wtr_timeout> : configuring wtr timeout

<group-id> : protection group id for configuring wtr time.

Syntax:

Erps wtr-timeout <wtr_timeout> <group-id>

Parameters:

<wtr_timeout>: timer timeout values

<group-id> : protection group id 1 - 64

ERPS Delete

Description:

deletion of a protection group

<group-id> : protection group id for deletion .

Syntax:

Erps delete <group-id>

Parameters:

<group-id>: protection group id 1 - 64

ERPS Topologychange

Description:

specifying topology change propagation parameters for a given protection group

[propagate|nopropagate] : enabling or disabling topology change propagation for a given group

<group_id> : protection group id

Syntax:

Erps topologychange [propagate|nopropagate] <group-id>

Parameters:

propagate|nopropagate: topology change propagation configuration

<group-id> : protection group id 1 - 64

ERPS Configuration

Description:

deletion of a protection group

<group-id> : protection group id

[statistics] : for displaying R-APS statistics

[clear] : for clearing R-APS statistics.

Syntax:

Erps configuration [<group-id>] [statistics|clear]

Parameters:

<group-id> : protection group id 1 - 64

statistics|clear: ERPS statistics

6.30 PTP Command

PTP Configuration

Description:

Set or show PTP configuration.

Syntax:

PTP Configuration [<clock inst>]

Parameters:

<clock inst>: Clock instance number [0...3]

Default Setting:

disable

PTP PortState

Description:

Set or show PTP port state.

Syntax:

PTP PortState <clockinst> [<port_list>] [enable|disable|internal]

Parameters:

<clockinst>: Clock instance number [0...3]

<port_list>: Port list or "all", default: All ports

Enable: Enable PTP port.

Disable: Disable PTP port.

Internal: Enable PTP port as internal (in a distributed environment)

Default Setting:

Show actual port state

PTP ClockCreate

Description:

Create or show a PTP clock instance data..

Syntax:

PTP ClockCreate <clockinst> [<devtype>] [<twostep>] [<protocol>] [<oneway>] [<clockid>] [<tag_enable>] [<vid>] [<prio>]

Parameters:

<clockinst> : clock instance number [0..3]

<devtype> : The devtype parameter takes the following values:

ord : Ordinary/Boundary clock

p2p: Peer-to-peer transparent clock

e2e: End-to-end transparent clock

mst: Master only clock

slv: Slave only clock

(default: Show actual init parameters)

<twostep>: The twostep parameter takes the following values:

true: Follow-up messages are used

false: No follow-up messages are used

<protocol>: The protocol parameter takes the following values:

ethernet : The clock uses multicast Ethernet protocol

ip4multi : The clock uses IPv4 multicast protocol

ip4uni: The clock uses IPv4 unicast protocol

Note: IPv4 unicast protocol only works in Master only and Slave only clocks

See parameter <devtype>

In a unicast Slave only clock you also need configure which master clocks to request Announce and Sync messages from. See command UniConfig

<oneway>: The oneway parameter takes the following values:

true: The clock slave uses one-way measurements, i.e. no delay requests

false: The clock slave uses two-way measurements

<clockid>: 8 byte clock identity(xx:xx:xx:xx:xx:xx:xx:xx)

<tag_enable>: The tag_enable parameter takes the following values:

true: The ptp frames are tagged with the VLAN tag specified in the VID field.

Note : Packets are only tagged if the port is configured for vlan tagging. i.e:

Port Type != Unaware and PortVLAN mode == None.

false: The ptp frames are sent untagged.

<vid>: The VID parameter takes the following values:

0 - 4095 : The range of VID's ptp can use to send tagged frames

<prio>: The Prio parameter takes the following values:

0 - 7: The range of Priorities ptp can use in the tagged frames

PTP ClockDelete

Description:

Delete a PTP clock instance.

Syntax:

PTP ClockDelete <clockinst> [<devtype>]

Parameters:

<clockinst>: clock instance number [0..3]

<devtype> : The devtype parameter takes the following values:

ord: Ordinary/Boundary clock

p2p: Peer-to-peer transparent clock

e2e: End-to-end transparent clock

mst: Master only clock

slv: Slave only clock

(default: Show actual init parameters)

PTP DefaultDS

Description:

Set or show PTP clock Default Data set priority1 and priority2 are used in the best master clock algorithm. Lower values take precedence.

Syntax:

PTP DefaultDS <clockinst> [<priority1>] [<priority2>] [<domain>]

Parameters:

<clockinst>: clock instance number [0..3]

<priority1>: [0..255] Clock priority 1 for PTP BMC algorithm

<priority2>: [0..255] Clock Priority 2 for PTP BMC algorithm

<domain>: [0..127] PTP clock domain id (0 = default) for PTP

PTP CurrentDS

Description:

Show PTP clock Current Data set.

Syntax:

PTP CurrentDS <clockinst>

Parameters:

<clockinst>: clock instance number [0..3]

PTP ParentDS

Description:

Show PTP clock Parent Data set.

Syntax:

PTP ParentDS <clockinst>

Parameters:

<clockinst>: clock instance number [0..3]

PTP Timingproperties

Description:

Set or show PTP clock Timing properties Data set.

Syntax:

PTP Timingproperties <clockinst> [<utcoffset>] [<valid>] [<leap59>] [<leap61>] [<timetrac>] [<freqtrac>] [<ptptimescale>]
[<timesource>]

Parameters:

<clockinst>: clock instance number [0..3]

<utcoffset>: PTP clock offset between UTC and TAI in seconds

<valid>: The offsetvalid parameter takes the following values:

false: The UTC offset is not valid

true: The UTC offset is valid

<leap59>: The leap59 parameter takes the following values:

false: no leap59 in current day

true: last minute of current day contains 59 sec.

<leap61>: The leap61 parameter takes the following values:

false: no leap61 in current day

true: last minute of current day contains 61 sec.

<timetrac>: The timetraceable parameter takes the following values:

false: timing is not traceable

true: timing is traceable.

<freqtrac>: The freqtraceable parameter takes the following values:

False: frequency is not traceable

true: frequency is traceable.

<ptptimescale>: The timescale parameter takes the following values:

false: timing is not a PTP time scale

true: timing is a PTP time scale.

<timesource>: [0..255] Time source.

16 (0x10) ATOMIC_CLOCK

32 (0x20) GPS

48 (0x30) TERRESTRIAL_RADIO

64 (0x40) PTP

80 (0x50) NTP

96 (0x60) HAND_SET

144 (0x90) OTHER

160 (0xA0) INTERNAL_OSCILLATOR

PTP PortDataSet

Description:

Set or show PTP port data set.

Syntax:

PTP PortDataSet <clockinst> [<port_list>] [<announceintv>] [<announceto>] [<syncintv>] [<delaymech>] [<minpdelayreqintv>] [<delayasymmetry>] [<ingressLatency>] [<egressLatency>]

Parameters:

<clockinst>: clock instance number [0..3]

<port_list>: Port list or 'all', default: All ports

<announceintv>: [-3..4] Log2 of mean announce interval in sec.

<announceto>: [-1..10] Log2 of announce receipt timeout in sec.

<syncintv>: [-7..4] Log2 of sync interval in sec.

<delaymech>: The delaymech parameter takes the following values:

e2e: The port is configured to use the delay request-response mechanism

p2p: The port is configured to use the peer delay mechanism

<minpdelayreqintv>: [-7..5] Log2 of min delay req interval in sec.

<delayasymmetry>: path delay asymmetry measured in ns

<ingresslatency>: ingress latency measured in ns

<egresslatency>: egress latency measured in ns

PTP LocalClock

Description:

Update or show PTP current time, or set master clock ratio.

Syntax:

PTP LocalClock <clockinst> [update|show|ratio] [<clockratio>]

Parameters:

<clockinst>: clock instance number [0..3]

update|show|ratio: PTP local clock

update: The local clock is synchronized to the eCos system clock

show: The local clock current time is shown

ratio: Set the local master clock frequency ratio in units of 0,1 PPB

(ratio > 0 => faster clock, ratio < 0 => slower clock)

<clockratio>: [-10.000.000..+10.000.000] Clock frequency ratio in 0,1 PPB.

PTP Filter

Description:

Set or show PTP clock filter data.

Syntax:

PTP Filter <clockinst> [<def_delay_filt>] [<period>] [<dist>]

Parameters:

<clockinst>: clock instance number [0..3]

<def_delay_filt>: [1..6] Log2 of timeconstant in delay filter.

<period>: [1..1000] Measurement period in number of sync events.

Note: In configurations with Timestamp enabled PHYs, the period is automatically increased, if (period*dist

< SyncPackets pr sec/4), i.e. max 4 adjustments are made pr sec.

<dist>: [1..10] Distance between servo update n number of measurement periods, if Distance is 1 the offset is averaged over the 'period', if Distance is >1 the offset is calculated using 'min' offset.

PTP Servo

Description:

Set or show PTP clock servo data.

Syntax:

PTP Servo <clockinst> [<displaystates>] [<ap_enable>] [<ai_enable>] [<ad_enable>] [<ap>] [<ai>] [<ad>]

Parameters:

<clockinst>: clock instance number [0..3]

<displaystates>: The displaystates parameter takes the following values:

true: Display clock state and measurements

false: don't display

<ap_enable>:

true: Enable the 'P' component in regulator

false: Disable the 'P' component in regulator

<ai_enable>:

true: Enable the 'I' component in regulator

false: Disable the 'I' component in regulator

<ad_enable>:

true: Enable the 'D' component in regulator

false: Disable the 'D' component in regulator

<ap>: [1..1000] 'P' component in regulator

<ai>: [1..10000] 'I' component in regulator.

<ad>: [1..10000] 'D' component in regulator.

PTP SlaveTableUnicast

Description:

Show the Unicast slave table of the requested unicast masters.

Syntax:

PTP SlaveTableUnicast <clockinst>

Parameters:

<clockinst>: clock instance number [0..3]

PTP SlaveTableUnicast

Description:

Set or show the Unicast Slave configuration.

Syntax:

PTP UniConfig <clockinst> [<index>] [<duration>] [<ip_addr>]

Parameters:

<clockinst>: clock instance number [0..3]

<index>: [0..4] Index in the slave table.

<duration>: [10..1000] Number of seconds for which the Announce/Sync messages are requested.

<ip_addr>: IPv4 address of requested master clock.

PTP ForeignMasters

Description:

Show PTP port foreign masters data set.

Syntax:

PTP ForeignMasters <clockinst> [<port_list>]

Parameters:

<clockinst>: clock instance number [0..3]

<port_list>: Port list or 'all', default: All ports

PTP EgressLatency

Description:

Show or clear the One-step egress latency observed in systems where the timestamp ping is done in SW.

Syntax:

PTP EgressLatency [show|clear]

Parameters:

show: Show the observed Egress latency

clear: Clear the observed Egress latency

PTP MasterTableUnicast**Description:**

Show the Unicast master table of the slaves that have requested unicast communication.

Syntax:

PTP MasterTableUnicast <clockinst>

Parameters:

<clockinst>: clock instance number [0..3]

PTP ExtClockMode**Description:**

Update or show the 1PPS and External clock output configuration and vcxo frequency rate adjustment option.

Luton26 has only one physical port, i.e. the one pps mode overrules the external clock output, therefore if one_pps_mode != disable, the ext_enable is ignored. (If vcxo mode is changed, the node must be restarted).

Syntax:

PTP ExtClockMode [<one_pps_mode>] [<ext_enable>] [<clockfreq>] [<vcxo_enable>]

Parameters:**<one_pps_mode>:**

output: Enable the 1 pps clock output

input: Enable the 1 pps clock input

disable: Disable the 1 pps clock in/out-put

<ext_enable>:

true: Enable the external clock output

false: Disable the external clock output

<clockfreq>: [1..25.000.000] External Clock output frequency in Hz.

<vcxo_enable> :

true: Enable the external VCXO rate adjustment

false: Disable the external VCXO rate adjustment

PTP OnePpsAction

Description:

Show [and clear] One PPS statistics.

Syntax:

PTP OnePpsAction [<one_pps_clear>]

Parameters:

<one_pps_clear>: default Dump statistics [1] Clear statistics.

7. SWITCH OPERATION

7.1 Address Table

The **Industrial Managed Switch** is implemented with an address table. This address table composed of many entries. Each entry is used to store the address information of some node in network, including MAC address, port no, etc. This information comes from the learning process of **Industrial Managed Switch**.

7.2 Learning

When one packet comes in from any port, the **Industrial Managed Switch** will record the source address, port no. And the other related information in address table. This information will be used to decide either forwarding or filtering for future packets.

7.3 Forwarding & Filtering

When one packet comes from some port of the **Industrial Managed Switch**, it will also check the destination address besides the source address learning. The **Industrial Managed Switch** will lookup the address-table for the destination address. If not found, this packet will be forwarded to all the other ports except the port, which this packet comes in. And these ports will transmit this packet to the network it connected. If found, and the destination address is located at different port from this packet comes in, the **Industrial Managed Switch** will forward this packet to the port where this destination address is located according to the information from address table. But, if the destination address is located at the same port with this packet comes in, then this packet will be filtered. Thereby increasing the network throughput and availability

7.4 Store-and-Forward

Store-and-Forward is one type of packet-forwarding techniques. A Store-and-Forward **Industrial Managed Switch** stores the incoming frame in an internal buffer, do the complete error checking before transmission. Therefore, no error packets occurrence, it is the best choice when a network needs efficiency and stability.

The **Industrial Managed Switch** scans the destination address from the packet-header, searches the routing table provided for the incoming port and forwards the packet, only if required. The fast forwarding makes the switch attractive for connecting servers directly to the network, thereby increasing throughput and availability. However, the switch is most commonly used to segment existence hubs, which nearly always improves overall performance. An Ethernet Switching can be easily configured in any Ethernet network environment to significantly boost bandwidth using conventional cabling and adapters.

Due to the learning function of the **Industrial Managed Switch**, the source address and corresponding port number of each incoming and outgoing packet are stored in a routing table. This information is subsequently used to filter packets whose destination address is on the same segment as the source address. This confines network traffic to its respective domain and reduce the overall load on the network.

The **Industrial Managed Switch** performs "**Store and Forward**" therefore, no error packets occur. More reliably, it reduces the re-transmission rate. No packet loss will occur.

7.5 Auto-Negotiation

The STP ports on the **Industrial Managed Switch** have built-in “**Auto-negotiation**”. This technology automatically sets the best possible bandwidth when a connection is established with another network device (usually at Power On or Reset). This is done by detect the modes and speeds at the second of both device is connected and capable of, both 10Base-T and 100Base-TX devices can connect with the port in either Half- or Full-Duplex mode. 1000Base-T can be only connected in Full-duplex mode.

8. TROUBLE SHOOTING

This chapter contains information to help you solve problems. If the **Industrial Managed Switch** is not functioning properly, make sure the Ethernet Switch was set up according to instructions in this manual.

The per port LED is not lit

Solution:

Check the cable connection of the **Industrial Managed Switch**.

Performance is bad

Solution:

Check the speed duplex mode of the partner device. The **Industrial Managed Switch** is run at Auto-negotiation mode and if the partner is set to half duplex, then the performance will be poor.

Per port LED is lit, but the traffic is irregular

Solution:

Check that the attached device is not set to dedicate full duplex. Some devices use a physical or software switch to change duplex modes. Auto-negotiation may not recognize this type of full-duplex setting.

Why the Industrial Managed Switch doesn't connect to the network

Solution:

Check per port LED on the **Industrial Managed Switch**. Try another port on the **Industrial Managed Switch**. Make sure the cable is installed properly. Make sure the cable is the right type. Turn off the power. After a while, turn on power again.

Can I install MGB-SX or other non wide temperature SFP module into SFP slot of Industrial Managed Switch?

Solution:

Yes, it does. However, since the MGB-SX and other non wide temperature SFP module cannot operate under -40 to 75 Degree C. Please pay attention to this point and consider use PLANET wide temperature SFP module for **Industrial Managed Switch**.

■ While IP Address be changed or forgotten admin password –

To reset the IP address to the default IP Address “192.168.0.100” or reset the password to default value. Press the hardware **reset button** at the front panel about **5 seconds**. After the device is rebooted, you can login the management WEB interface within the same subnet of 192.168.0.xx.

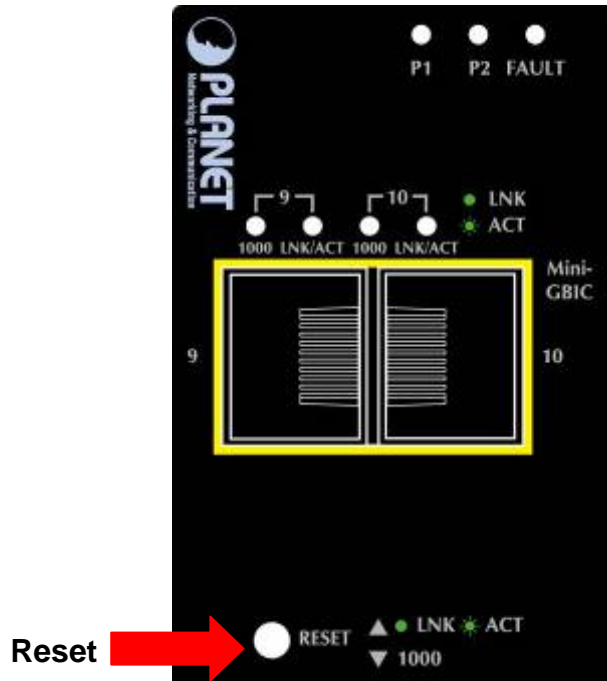

APPENDIX A

A.1 Switch's Data RJ-45 Pin Assignments - 1000Mbps, 1000Base-T

PIN NO	MDI	MDI-X
1	BI_DA+	BI_DB+
2	BI_DA-	BI_DB-
3	BI_DB+	BI_DA+
4	BI_DC+	BI_DD+
5	BI_DC-	BI_DD-
6	BI_DB-	BI_DA-
7	BI_DD+	BI_DC+
8	BI_DD-	BI_DC-

Implicit implementation of the crossover function within a twisted-pair cable, or at a wiring panel, while not expressly forbidden, is beyond the scope of this standard.

A.2 10/100Mbps, 10/100Base-TX

When connecting your 10/100Mbps Ethernet Switch to another switch, a bridge or a hub, a straight or crossover cable is necessary. Each port of the Switch supports auto-MDI/MDI-X detection. That means you can directly connect the Switch to any Ethernet devices without making a crossover cable. The following table and diagram show the standard RJ-45 receptacle/connector and their pin assignments:

RJ-45 Connector pin assignment		
Contact	MDI	MDI-X
	Media Dependant Interface	Media Dependant Interface-Cross
1	Tx + (transmit)	Rx + (receive)
2	Tx - (transmit)	Rx - (receive)
3	Rx + (receive)	Tx + (transmit)
4, 5	Not used	
6	Rx - (receive)	Tx - (transmit)
7, 8	Not used	

The standard cable, RJ-45 pin assignment

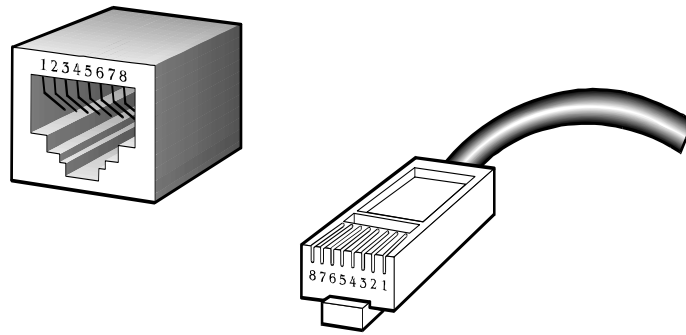

The standard RJ-45 receptacle/connector

There are 8 wires on a standard UTP/STP cable and each wire is color-coded. The following shows the pin allocation and color of straight cable and crossover cable connection:

Straight Cable		SIDE 1	SIDE2						
1	2	3	4	5	6	7	8	SIDE 1 1 = White / Orange 2 = Orange 3 = White / Green 4 = Blue 5 = White / Blue 6 = Green 7 = White / Brown 8 = Brown SIDE 2 1 = White / Orange 2 = Orange 3 = White / Green 4 = Blue 5 = White / Blue 6 = Green 7 = White / Brown 8 = Brown	SIDE 1 1 = White / Orange 2 = Orange 3 = White / Green 4 = Blue 5 = White / Blue 6 = Green 7 = White / Brown 8 = Brown SIDE 2 1 = White / Green 2 = Green 3 = White / Orange 4 = Blue 5 = White / Blue 6 = Orange 7 = White / Brown 8 = Brown
1	2	3	4	5	6	7	8		
1	2	3	4	5	6	7	8		
1	2	3	4	5	6	7	8		
1	2	3	4	5	6	7	8		
1	2	3	4	5	6	7	8		
1	2	3	4	5	6	7	8		
1	2	3	4	5	6	7	8		
Crossover Cable		SIDE 1	SIDE2						
1	2	3	4	5	6	7	8	SIDE 1 1 = White / Orange 2 = Orange 3 = White / Green 4 = Blue 5 = White / Blue 6 = Green 7 = White / Brown 8 = Brown SIDE 2 1 = White / Green 2 = Green 3 = White / Orange 4 = Blue 5 = White / Blue 6 = Orange 7 = White / Brown 8 = Brown	SIDE 1 1 = White / Orange 2 = Orange 3 = White / Green 4 = Blue 5 = White / Blue 6 = Green 7 = White / Brown 8 = Brown SIDE 2 1 = White / Green 2 = Green 3 = White / Orange 4 = Blue 5 = White / Blue 6 = Orange 7 = White / Brown 8 = Brown
1	2	3	4	5	6	7	8		
1	2	3	4	5	6	7	8		
1	2	3	4	5	6	7	8		
1	2	3	4	5	6	7	8		
1	2	3	4	5	6	7	8		
1	2	3	4	5	6	7	8		
1	2	3	4	5	6	7	8		

Figure A-1: Straight-Through and Crossover Cable

Please make sure your connected cables are with same pin assignment and color as above picture before deploying the cables into your network.

APPENDIX B : GLOSSARY

A

ACE

ACE is an acronym for **A**ccess **C**ontrol **E**ntry. It describes access permission associated with a particular ACE ID.

There are three ACE frame types (Ethernet Type, ARP, and IPv4) and two ACE actions (permit and deny). The ACE also contains many detailed, different parameter options that are available for individual application.

ACL

ACL is an acronym for **A**ccess **C**ontrol **L**ist. It is the list table of ACEs, containing access control entries that specify individual users or groups permitted or denied to specific traffic objects, such as a process or a program.

Each accessible traffic object contains an identifier to its ACL. The privileges determine whether there are specific traffic object access rights.

ACL implementations can be quite complex, for example, when the ACEs are prioritized for the various situation. In networking, the ACL refers to a list of service ports or network services that are available on a host or server, each with a list of hosts or servers permitted or denied to use the service. ACL can generally be configured to control inbound traffic, and in this context, they are similar to firewalls.

There are 3 web-pages associated with the manual ACL configuration:

ACL|Access Control List: The web page shows the ACEs in a prioritized way, highest (top) to lowest (bottom). Default the table is empty. An ingress frame will only get a hit on one ACE even though there are more matching ACEs. The first matching ACE will take action (permit/deny) on that frame and a counter associated with that ACE is incremented. An ACE can be associated with a Policy, 1 ingress port, or any ingress port (the whole switch). If an ACE Policy is created then that Policy can be associated with a group of ports under the "Ports" web-page. There are number of parameters that can be configured with an ACE. Read the Web page help text to get further information for each of them. The maximum number of ACEs is 64.

ACL|Ports: The ACL Ports configuration is used to assign a Policy ID to an ingress port. This is useful to group ports to obey the same traffic rules. Traffic Policy is created under the "Access Control List" - page. You can you also set up specific traffic properties (Action / Rate Limiter / Port copy, etc) for each ingress port. They will though only apply if the frame gets past the ACE matching without getting matched. In that case a counter associated with that port is incremented. See the Web page help text for each specific port property.

ACL|Rate Limiters: Under this page you can configure the rate limiters. There can be 15 different rate limiters, each

ranging from 1-1024K packets per seconds. Under "Ports" and "Access Control List" web-pages you can assign a Rate Limiter ID to the ACE(s) or ingress port(s).

AES

AES is an acronym for Advanced Encryption Standard. The encryption key protocol is applied in 802.1i standard to improve WLAN security. It is an encryption standard by the U.S. government, which will replace DES and 3DES. AES has a fixed block size of 128 bits and a key size of 128, 192, or 256 bits.

APS

APS is an acronym for Automatic Protection Switching. This protocol is used to secure that switching is done bidirectional in the two ends of a protection group, as defined in G.8031.

Aggregation

Using multiple ports in parallel to increase the link speed beyond the limits of a port and to increase the redundancy for higher availability.

(Also *Port Aggregation, Link Aggregation*).

ARP

ARP is an acronym for Address Resolution Protocol. It is a protocol that used to convert an IP address into a physical address, such as an Ethernet address. ARP allows a host to communicate with other hosts when only the Internet address of its neighbors is known. Before using IP, the host sends a broadcast ARP request containing the Internet address of the desired destination system.

ARP Inspection

ARP Inspection is a secure feature. Several types of attacks can be launched against a host or devices connected to Layer 2 networks by "poisoning" the ARP caches. This feature is used to block such attacks. Only valid ARP requests and responses can go through the switch device.

Auto-Negotiation

Auto-negotiation is the process where two different devices establish the mode of operation and the speed settings that can be shared by those devices for a link.

C

CC

CC is an acronym for Continuity Check. It is a MEP functionality that is able to detect loss of continuity in a network by transmitting CCM frames to a peer MEP.

CCM

CCM is an acronym for Continuity Check Message. It is a OAM frame transmitted from a MEP to it's peer MEP and used to implement CC functionality.

CDP

CDP is an acronym for Cisco Discovery Protocol.

D

DEI

DEI is an acronym for Drop Eligible Indicator. It is a 1-bit field in the VLAN tag.

DES

DES is an acronym for Data Encryption Standard. It provides a complete description of a mathematical algorithm for encrypting (enciphering) and decrypting (deciphering) binary coded information.

Encrypting data converts it to an unintelligible form called cipher. Decrypting cipher converts the data back to its original form called plaintext. The algorithm described in this standard specifies both enciphering and deciphering operations which are based on a binary number called a key.

DHCP

DHCP is an acronym for Dynamic Host Configuration Protocol. It is a protocol used for assigning dynamic IP addresses to devices on a network.

DHCP used by networked computers (clients) to obtain IP addresses and other parameters such as the default gateway, subnet mask, and IP addresses of DNS servers from a DHCP server.

The DHCP server ensures that all IP addresses are unique, for example, no IP address is assigned to a second client while the first client's assignment is valid (its lease has not expired). Therefore, IP address pool management is done by the server and not by a human network administrator.

Dynamic addressing simplifies network administration because the software keeps track of IP addresses rather than requiring an administrator to manage the task. This means that a new computer can be added to a network without the hassle of manually assigning it a unique IP address.

DHCP Relay

DHCP Relay is used to forward and to transfer DHCP messages between the clients and the server when they are not on the same subnet domain.

The DHCP option 82 enables a DHCP relay agent to insert specific information into a DHCP request packets when forwarding client DHCP packets to a DHCP server and remove the specific information from a DHCP reply packets when forwarding server DHCP packets to a DHCP client. The DHCP server can use this information to implement IP address or other assignment policies. Specifically the option works by setting two sub-options: Circuit ID (option 1) and Remote ID (option2). The Circuit ID sub-option is supposed to include information specific to which circuit the request came in on. The Remote ID sub-option was designed to carry information relating to the remote host end of the circuit.

The definition of Circuit ID in the switch is 4 bytes in length and the format is "vlan_id" "module_id" "port_no". The parameter of "vlan_id" is the first two bytes represent the VLAN ID. The parameter of "module_id" is the third byte for the module ID (in standalone switch it always equal 0, in stackable switch it means switch ID). The parameter of "port_no" is the fourth byte and it means the port number.

The Remote ID is 6 bytes in length, and the value is equal the DHCP relay agents MAC address.

DHCP Snooping

DHCP Snooping is used to block intruder on the untrusted ports of the switch device when it tries to intervene by injecting a bogus DHCP reply packet to a legitimate conversation between the DHCP client and server.

DNS

DNS is an acronym for **D**omain **N**ame **S**ystem. It stores and associates many types of information with domain names. Most importantly, DNS translates human-friendly domain names and computer hostnames into computer-friendly IP addresses. For example, the domain name www.example.com might translate to 192.168.0.1.

DoS

DoS is an acronym for **D**enial of **S**ervice. In a denial-of-service (DoS) attack, an attacker attempts to prevent legitimate users from accessing information or services. By targeting at network sites or network connection, an attacker may be able to prevent network users from accessing email, web sites, online accounts (banking, etc.), or other services that rely on the affected computer.

Dotted Decimal Notation

Dotted Decimal Notation refers to a method of writing IP addresses using decimal numbers and dots as separators between octets.

An IPv4 dotted decimal address has the form x.y.z.w, where x, y, z, and w are decimal numbers between 0 and 255.

DSCP

DSCP is an acronym for **D**ifferentiated **S**ervices **C**ode **P**oint. It is a field in the header of IP packets for packet classification purposes.

E

EEE

EEE is an abbreviation for Energy Efficient Ethernet defined in IEEE 802.3az.

EPS

EPS is an abbreviation for Ethernet Protection Switching defined in ITU/T G.8031.

Ethernet Type

Ethernet Type, or EtherType, is a field in the Ethernet MAC header, defined by the Ethernet networking standard. It is used to indicate which protocol is being transported in an Ethernet frame.

F

FTP

FTP is an acronym for **F**ile **T**ransfer **P**rotocol. It is a transfer protocol that uses the Transmission Control Protocol (TCP) and provides file writing and reading. It also provides directory service and security features.

Fast Leave

IGMP snooping Fast Leave processing allows the switch to remove an interface from the forwarding-table entry without first sending out group specific queries to the interface. The VLAN interface is pruned from the multicast tree for the multicast group specified in the original leave message. Fast-leave processing ensures optimal bandwidth management for all hosts on a switched network, even when multiple multicast groups are in use simultaneously.

H

HTTP

HTTP is an acronym for **H**ypertext **T**ransfer **P**rotocol. It is a protocol that used to transfer or convey information on the World Wide Web (WWW).

HTTP defines how messages are formatted and transmitted, and what actions Web servers and browsers should take in response to various commands. For example, when you enter a URL in your browser, this actually sends an HTTP command to the Web server directing it to fetch and transmit the requested Web page. The other main standard that controls how the World Wide Web works is HTML, which covers how Web pages are formatted and displayed.

Any Web server machine contains, in addition to the Web page files it can serve, an HTTP daemon, a program that is designed to wait for HTTP requests and handle them when they arrive. The Web browser is an HTTP client, sending requests to server machines. An HTTP client initiates a request by establishing a Transmission Control Protocol (TCP) connection to a particular port on a remote host (port 80 by default). An HTTP server listening on that port waits for the client to send a request message.

HTTPS

HTTPS is an acronym for **H**ypertext **T**ransfer **P**rotocol over **S**ecure Socket Layer. It is used to indicate a secure HTTP connection.

HTTPS provide authentication and encrypted communication and is widely used on the World Wide Web for security-sensitive communication such as payment transactions and corporate logons.

HTTPS is really just the use of Netscape's Secure Socket Layer (SSL) as a sublayer under its regular HTTP application layering. (HTTPS uses port 443 instead of HTTP port 80 in its interactions with the lower layer, TCP/IP.) SSL uses a 40-bit key size for the RC4 stream encryption algorithm, which is considered an adequate degree of encryption for commercial exchange.

ICMP

ICMP is an acronym for **I**nternet **C**ontrol **M**essage **P**rotocol. It is a protocol that generated the error response, diagnostic or routing purposes. ICMP messages generally contain information about routing difficulties or simple exchanges such as time-stamp or echo transactions. For example, the PING command uses ICMP to test an Internet connection.

IEEE 802.1X

IEEE 802.1X is an IEEE standard for port-based Network Access Control. It provides authentication to devices attached to a LAN port, establishing a point-to-point connection or preventing access from that port if authentication fails. With 802.1X, access to all switch ports can be centrally controlled from a server, which means that authorized users can use the same credentials for authentication from any point within the network.

IGMP

IGMP is an acronym for **I**nternet **G**roup **M**anagement **P**rotocol. It is a communications protocol used to manage the membership of Internet Protocol multicast groups. IGMP is used by IP hosts and adjacent multicast routers to establish multicast group memberships. It is an integral part of the IP multicast specification, like ICMP for unicast connections. IGMP can be used for online video and gaming, and allows more efficient use of resources when supporting these uses.

IGMP Querier

A router sends IGMP Query messages onto a particular link. This router is called the Querier.

IMAP

IMAP is an acronym for **I**nternet **M**essage **A**ccess **P**rotocol. It is a protocol for email clients to retrieve email messages from a mail server.

IMAP is the protocol that IMAP clients use to communicate with the servers, and SMTP is the protocol used to transport mail to an IMAP server.

The current version of the Internet Message Access Protocol is IMAP4. It is similar to Post Office Protocol version 3 (POP3), but offers additional and more complex features. For example, the IMAP4 protocol leaves your email messages on the server rather than downloading them to your computer. If you wish to remove your messages from the server, you must use your mail client to generate local folders, copy messages to your local hard drive, and then delete and expunge the messages from the server.

IP

IP is an acronym for **I**nternet **P**rotocol. It is a protocol used for communicating data across a internet network.

IP is a "best effort" system, which means that no packet of information sent over it is assured to reach its destination in the same condition it was sent. Each device connected to a Local Area Network (LAN) or Wide Area Network (WAN) is given an Internet Protocol address, and this IP address is used to identify the device uniquely among all other devices connected to the extended network.

The current version of the Internet protocol is IPv4, which has 32-bits Internet Protocol addresses allowing for in excess of four billion unique addresses. This number is reduced drastically by the practice of webmasters taking addresses in large blocks, the bulk of which remain unused. There is a rather substantial movement to adopt a new version of the Internet Protocol, IPv6, which would have 128-bits Internet Protocol addresses. This number can be represented roughly by a three with thirty-nine zeroes after it. However, IPv4 is still the protocol of choice for most of the Internet.

IPMC

IPMC is an acronym for **I**P **M**ulti**C**ast.

IP Source Guard

IP Source Guard is a secure feature used to restrict IP traffic on DHCP snooping untrusted ports by filtering traffic based on the DHCP Snooping Table or manually configured IP Source Bindings. It helps prevent IP spoofing attacks when a host tries to spoof and use the IP address of another host.

L**LACP**

LACP is an IEEE 802.3ad standard protocol. The **L**ink **A**ggregation **C**ontrol **P**rotocol, allows bundling several physical ports together to form a single logical port.

LLDP

LLDP is an IEEE 802.1ab standard protocol.

The **L**ink **L**ayer **D**iscovery **P**rotocol(LLDP) specified in this standard allows stations attached to an IEEE 802 LAN to advertise, to other stations attached to the same IEEE 802 LAN, the major capabilities provided by the system incorporating that station, the management address or addresses of the entity or entities that provide management of those capabilities, and the identification of the stations point of attachment to the IEEE 802 LAN required by those management entity or entities. The information distributed via this protocol is stored by its recipients in a standard Management Information Base (MIB), making it possible for the information to be accessed by a Network Management System (NMS) using a management protocol such as the Simple Network Management Protocol (SNMP).

LLDP-MED

LLDP-MED is an extension of IEEE 802.1ab and is defined by the telecommunication industry association (TIA-1057).

LOC

LOC is an acronym for Loss Of Connectivity and is detected by a MEP and is indicating lost connectivity in the network. Can be used as a switch criteria by EPS

M**MAC Table**

Switching of frames is based upon the DMAC address contained in the frame. The switch builds up a table that maps MAC addresses to switch ports for knowing which ports the frames should go to (based upon the DMAC address in the frame). This table contains both static and dynamic entries. The static entries are configured by the network administrator if the administrator wants to do a fixed mapping between the DMAC address and switch ports.

The frames also contain a MAC address (SMAC address), which shows the MAC address of the equipment sending the frame. The SMAC address is used by the switch to automatically update the MAC table with these dynamic MAC addresses. Dynamic entries are removed from the MAC table if no frame with the corresponding SMAC address have been seen after a configurable age time.

MEP

MEP is an acronym for Maintenance Entity Endpoint and is an endpoint in a Maintenance Entity Group (ITU-T Y.1731).

MD5

MD5 is an acronym for Message-Digest algorithm 5. MD5 is a message digest algorithm, used cryptographic hash function with a 128-bit hash value. It was designed by Ron Rivest in 1991. MD5 is officially defined in RFC 1321 - The MD5 Message-Digest Algorithm.

Mirroring

For debugging network problems or monitoring network traffic, the switch system can be configured to mirror frames from multiple ports to a mirror port. (In this context, mirroring a frame is the same as copying the frame.)

Both incoming (source) and outgoing (destination) frames can be mirrored to the mirror port.

MLD

MLD is an acronym for Multicast Listener Discovery for IPv6. MLD is used by IPv6 routers to discover multicast listeners on a directly attached link, much as IGMP is used in IPv4. The protocol is embedded in ICMPv6 instead of using a separate protocol.

MVR

Multicast VLAN Registration (MVR) is a protocol for Layer 2 (IP)-networks that enables multicast-traffic from a source VLAN to be shared with subscriber-VLANs.

The main reason for using MVR is to save bandwidth by preventing duplicate multicast streams being sent in the core network, instead the stream(s) are received on the MVR-VLAN and forwarded to the VLANs where hosts have requested it/them(Wikipedia).

N

NAS

NAS is an acronym for Network Access Server. The NAS is meant to act as a gateway to guard access to a protected source. A client connects to the NAS, and the NAS connects to another resource asking whether the client's supplied credentials are valid. Based on the answer, the NAS then allows or disallows access to the protected resource. An example of a NAS implementation is IEEE 802.1X.

NetBIOS

NetBIOS is an acronym for **N**etwork **B**asic **I**nput/**O**utput **S**ystem. It is a program that allows applications on separate computers to communicate within a Local Area Network (LAN), and it is not supported on a Wide Area Network (WAN).

The NetBIOS giving each computer in the network both a NetBIOS name and an IP address corresponding to a different host name, provides the session and transport services described in the Open Systems Interconnection (OSI) model.

NFS

NFS is an acronym for **N**etwork **F**ile **S**ystem. It allows hosts to mount partitions on a remote system and use them as though they are local file systems.

NFS allows the system administrator to store resources in a central location on the network, providing authorized users continuous access to them, which means NFS supports sharing of files, printers, and other resources as persistent storage over a computer network.

NTP

NTP is an acronym for **N**etwork **T**ime **P**rotocol, a network protocol for synchronizing the clocks of computer systems. NTP uses UDP (datagrams) as transport layer.

O

OAM

OAM is an acronym for **O**peration **A**dministration and **M**aintenance.

It is a protocol described in ITU-T Y.1731 used to implement carrier ethernet functionality. MEP functionality like CC and RDI is based on this.

Optional TLVs.

A LLDP frame contains multiple TLVs

For some TLVs it is configurable if the switch shall include the TLV in the LLDP frame. These TLVs are known as optional TLVs. If an optional TLV is disabled the corresponding information is not included in the LLDP frame.

OUI

OUI is the organizationally unique identifier. An OUI address is a globally unique identifier assigned to a vendor by IEEE. You can determine which vendor a device belongs to according to the OUI address which forms the first 24 bits of a MAC address.

P

PCP

PCP is an acronym for Priority Code Point. It is a 3-bit field storing the priority level for the 802.1Q frame. It is also known as User Priority.

PD

PD is an acronym for **P**owered **D**evice. In a PoE system the power is delivered from a PSE (power sourcing equipment) to a remote device. The remote device is called a PD.

PHY

PHY is an abbreviation for Physical Interface Transceiver and is the device that implements the Ethernet physical layer (IEEE-802.3).

PING

ping is a program that sends a series of packets over a network or the Internet to a specific computer in order to generate a response from that computer. The other computer responds with an acknowledgment that it received the packets. Ping was created to verify whether a specific computer on a network or the Internet exists and is connected.

ping uses Internet Control Message Protocol (ICMP) packets. The PING Request is the packet from the origin computer, and the PING Reply is the packet response from the target.

PoE

PoE is an acronym for **P**ower **O**ver **E**thernet.

Power Over Ethernet is used to transmit electrical power, to remote devices over standard Ethernet cable. It could for example be used for powering IP telephones, wireless LAN access points and other equipment, where it would be difficult or expensive to connect the equipment to main power supply.

Policer

A policer can limit the bandwidth of received frames. It is located in front of the ingress queue.

POP3

POP3 is an acronym for **P**ost **O**ffice **P**rotocol version 3. It is a protocol for email clients to retrieve email messages from a mail server.

POP3 is designed to delete mail on the server as soon as the user has downloaded it. However, some implementations allow users or an administrator to specify that mail be saved for some period of time. POP can be thought of as a "store-and-forward" service.

An alternative protocol is Internet Message Access Protocol (IMAP). IMAP provides the user with more capabilities for retaining e-mail on the server and for organizing it in folders on the server. IMAP can be thought of as a remote file server.

POP and IMAP deal with the receiving of e-mail and are not to be confused with the Simple Mail Transfer Protocol (SMTP). You send e-mail with SMTP, and a mail handler receives it on your recipient's behalf. Then the mail is read using POP or IMAP. IMAP4 and POP3 are the two most prevalent Internet standard protocols for e-mail retrieval. Virtually all modern e-mail clients and servers support both.

PPPoE

PPPoE is an acronym for Point-to-Point Protocol over Ethernet.

It is a network protocol for encapsulating Point-to-Point Protocol (PPP) frames inside Ethernet frames. It is used mainly with ADSL services where individual users connect to the ADSL transceiver (modem) over Ethernet and in plain Metro Ethernet networks (Wikipedia).

Private VLAN

In a private VLAN, communication between ports in that private VLAN is not permitted. A VLAN can be configured as a private VLAN.

PTP

PTP is an acronym for Precision Time Protocol, a network protocol for synchronizing the clocks of computer systems.

Q

QCE

QCE is an acronym for **Q**oS **C**ontrol **E**ntry. It describes QoS class associated with a particular QCE ID.

There are six QCE frame types: Ethernet Type, VLAN, UDP/TCP Port, DSCP, TOS, and Tag Priority. Frames can be classified by one of 4 different QoS classes: "Low", "Normal", "Medium", and "High" for individual application.

QCL

QCL is an acronym for **Q**oS **C**ontrol **L**ist. It is the list table of QCEs, containing QoS control entries that classify to a specific QoS class on specific traffic objects.

Each accessible traffic object contains an identifier to its QCL. The privileges determine specific traffic object to specific QoS class.

QL

QL In SyncE this is the Quality Level of a given clock source. This is received on a port in a SSM indicating the quality of the clock received in the port.

QoS

QoS is an acronym for **Q**uality **o**f **S**ervice. It is a method to guarantee a bandwidth relationship between individual applications or protocols.

A communications network transports a multitude of applications and data, including high-quality video and delay-sensitive data such as real-time voice. Networks must provide secure, predictable, measurable, and sometimes guaranteed services.

Achieving the required QoS becomes the secret to a successful end-to-end business solution. Therefore, QoS is the set of techniques to manage network resources.

R

RARP

RARP is an acronym for **R**everse **A**ddress **R**esolution **P**rotocol. It is a protocol that is used to obtain an IP address for a given hardware address, such as an Ethernet address. RARP is the complement of ARP.

RADIUS

RADIUS is an acronym for **R**emote **A**uthentication **D**ial In **U**ser **S**ervice. It is a networking protocol that provides centralized access, authorization and accounting management for people or computers to connect and use a network service.

RDI

RDI is an acronym for **R**emote **D**efect **I**ndication. It is a OAM functionality that is used by a MEP to indicate defect detected to the remote peer MEP

Router Port

A router port is a port on the Ethernet switch that leads switch towards the Layer 3 multicast device.

RSTP

In 1998, the IEEE with document 802.1w introduced an evolution of STP: the **R**apid **S**panning **T**ree **P**rotocol, which provides for faster spanning tree convergence after a topology change. Standard IEEE 802.1D-2004 now incorporates RSTP and obsoletes STP, while at the same time being backwards-compatible with STP.

S

SAMBA

Samba is a program running under UNIX-like operating systems that provides seamless integration between UNIX and Microsoft Windows machines. Samba acts as file and print servers for Microsoft Windows, IBM OS/2, and other SMB client machines. Samba uses the Server Message Block (SMB) protocol and Common Internet File System (CIFS), which is the underlying protocol used in Microsoft Windows networking.

Samba can be installed on a variety of operating system platforms, including Linux, most common Unix platforms, OpenVMS, and IBM OS/2.

Samba can also register itself with the master browser on the network so that it would appear in the listing of hosts in Microsoft Windows "Neighborhood Network".

SHA

SHA is an acronym for **S**ecure **H**ash **A**lgorithm. It designed by the National Security Agency (NSA) and published by the NIST as a U.S. Federal Information Processing Standard. Hash algorithms compute a fixed-length digital representation (known as a message digest) of an input data sequence (the message) of any length.

Shaper

A shaper can limit the bandwidth of transmitted frames. It is located after the ingress queues.

SMTP

SMTP is an acronym for **S**imple **M**ail **T**ransfer **P**rotocol. It is a text-based protocol that uses the Transmission Control Protocol (TCP) and provides a mail service modeled on the FTP file transfer service. SMTP transfers mail messages between systems and notifications regarding incoming mail.

SNAP

The SubNetwork Access Protocol (SNAP) is a mechanism for multiplexing, on networks using IEEE 802.2 LLC, more protocols than can be distinguished by the 8-bit 802.2 Service Access Point (SAP) fields. SNAP supports identifying protocols by Ethernet type field values; it also supports vendor-private protocol identifier.

SNMP

SNMP is an acronym for **S**imple **N**etwork **M**anagement **P**rotocol. It is part of the Transmission Control Protocol/Internet Protocol (TCP/IP) protocol for network management. SNMP allow diverse network objects to participate in a network management architecture. It enables network management systems to learn network problems by receiving traps or change notices from network devices implementing SNMP.

SNTP

SNTP is an acronym for **S**imple **N**etwork **T**ime **P**rotocol, a network protocol for synchronizing the clocks of computer systems. SNTP uses UDP (datagrams) as transport layer.

SPROUT

Stack **P**rotocol using **R**outing **T**echnology. An advanced protocol for almost instantaneous discovery of topology changes within a stack as well as election of a master switch. SPROUT also calculates parameters for setting up each switch to perform shortest path forwarding within the stack.

SSID

Service **S**et **I**dentifier is a name used to identify the particular 802.11 wireless LANs to which a user wants to attach. A client device will receive broadcast messages from all access points within range advertising their SSIDs, and can choose one to connect to based on pre-configuration, or by displaying a list of SSIDs in range and asking the user to select one (wikipedia).

SSH

SSH is an acronym for **S**ecure **S**hell. It is a network protocol that allows data to be exchanged using a secure channel between two networked devices. The encryption used by SSH provides confidentiality and integrity of data over an insecure network. The goal of SSH was to replace the earlier rlogin, TELNET and rsh protocols, which did not provide strong authentication or guarantee confidentiality (Wikipedia).

SSM

SSM In SyncE this is an abbreviation for Synchronization Status Message and is containing a QL indication.

STP

Spanning **T**ree **P**rotocol is an OSI layer-2 protocol which ensures a loop free topology for any bridged LAN. The original STP protocol is now obsolete by RSTP.

Switch ID

Switch IDs (1-16) are used to uniquely identify the switches within a stack. The Switch ID of each switch is shown on the display on the front of the switch and is used widely in the web pages as well as in the CLI commands.

SyncE

SyncE Is an abbreviation for Synchronous Ethernet. This functionality is used to make a network 'clock frequency' synchronized. Not to be confused with real time clock synchronized (IEEE 1588).

T**TACACS+**

TACACS+ is an acronym for **T**erminal **A**ccess **C**ontroller **A**ccess **C**ontrol **S**ystem **P**lus. It is a networking protocol which provides access control for routers, network access servers and other networked computing devices via one or more centralized servers. TACACS+ provides separate authentication, authorization and accounting services.

Tag Priority

Tag Priority is a 3-bit field storing the priority level for the 802.1Q frame.

TCP

TCP is an acronym for **T**ransmission **C**ontrol **P**rotocol. It is a communications protocol that uses the Internet Protocol (IP) to exchange the messages between computers.

The TCP protocol guarantees reliable and in-order delivery of data from sender to receiver and distinguishes data for multiple connections by concurrent applications (for example, Web server and e-mail server) running on the same host.

The applications on networked hosts can use TCP to create connections to one another. It is known as a connection-oriented protocol, which means that a connection is established and maintained until such time as the message or messages to be exchanged by the application programs at each end have been exchanged. TCP is responsible for ensuring that a message is divided into the packets that IP manages and for reassembling the packets back into the complete message at the other end.

Common network applications that use TCP include the World Wide Web (WWW), e-mail, and File Transfer Protocol (FTP).

TELNET

TELNET is an acronym for **T**ELetype **N**ETwork. It is a terminal emulation protocol that uses the Transmission Control Protocol (TCP) and provides a virtual connection between TELNET server and TELNET client.

TELNET enables the client to control the server and communicate with other servers on the network. To start a Telnet session, the client user must log in to a server by entering a valid username and password. Then, the client user can enter commands through the Telnet program just as if they were entering commands directly on the server console.

TFTP

TFTP is an acronym for **T**rivial **F**ile **T**ransfer **P**rotocol. It is transfer protocol that uses the User Datagram Protocol (UDP) and provides file writing and reading, but it does not provides directory service and security features.

ToS

ToS is an acronym for **T**ype **o**f **S**ervice. It is implemented as the IPv4 ToS priority control. It is fully decoded to determine the priority from the 6-bit ToS field in the IP header. The most significant 6 bits of the ToS field are fully decoded into 64 possibilities, and the singular code that results is compared against the corresponding bit in the IPv4 ToS priority control bit (0~63).

TLV

TLV is an acronym for **T**ype **L**ength **V**alue. A LLDP frame can contain multiple pieces of information. Each of these pieces of information is known as TLV.

TKIP

TKIP is an acronym for **T**emporal **K**ey **I**ntegrity **P**rotocol. It used in WPA to replace WEP with a new encryption algorithm. TKIP comprises the same encryption engine and RC4 algorithm defined for WEP. The key used for encryption in TKIP is 128 bits and changes the key used for each packet.

U

UDP

UDP is an acronym for **U**ser **D**atagram **P**rotocol. It is a communications protocol that uses the Internet Protocol (IP) to exchange the messages between computers.

UDP is an alternative to the Transmission Control Protocol (TCP) that uses the Internet Protocol (IP). Unlike TCP, UDP does not provide the service of dividing a message into packet datagrams, and UDP doesn't provide reassembling and sequencing of the packets. This means that the application program that uses UDP must be able to make sure that the entire message has arrived and is in the right order. Network applications that want to save processing time because they have very small data units to exchange may prefer UDP to TCP.

UDP provides two services not provided by the IP layer. It provides port numbers to help distinguish different user requests and, optionally, a checksum capability to verify that the data arrived intact.

Common network applications that use UDP include the Domain Name System (DNS), streaming media applications such as IPTV, Voice over IP (VoIP), and Trivial File Transfer Protocol (TFTP).

UPnP

UPnP is an acronym for **U**niversal **P**lug and **P**lay. The goals of UPnP are to allow devices to connect seamlessly and to simplify the implementation of networks in the home (data sharing, communications, and entertainment) and in corporate environments for simplified installation of computer components

User Priority

User Priority is a 3-bit field storing the priority level for the 802.1Q frame.

V

VLAN

Virtual LAN. A method to restrict communication between switch ports. VLANs can be used for the following applications:

VLAN unaware switching: This is the default configuration. All ports are VLAN unaware with Port VLAN ID 1 and members of VLAN 1. This means that MAC addresses are learned in VLAN 1, and the switch does not remove or insert VLAN tags.

VLAN aware switching: This is based on the IEEE 802.1Q standard. All ports are VLAN aware. Ports connected to VLAN aware switches are members of multiple VLANs and transmit tagged frames. Other ports are members of one VLAN, set up with this Port VLAN ID, and transmit untagged frames.

Provider switching: This is also known as Q-in-Q switching. Ports connected to subscribers are VLAN unaware, members of one VLAN, and set up with this unique Port VLAN ID. Ports connected to the service provider are VLAN aware, members of multiple VLANs, and set up to tag all frames. Untagged frames received on a subscriber port are forwarded to the provider port with a single VLAN tag. Tagged frames received on a subscriber port are forwarded to the provider port with a double VLAN tag.

VLAN ID

VLAN ID is a 12-bit field specifying the VLAN to which the frame belongs.

Voice VLAN

Voice VLAN is VLAN configured specially for voice traffic. By adding the ports with voice devices attached to voice VLAN, we can perform QoS-related configuration for voice data, ensuring the transmission priority of voice traffic and voice quality.

W

WEP

WEP is an acronym for **W**ired **E**quivalent **P**rivacy. WEP is a deprecated algorithm to secure IEEE 802.11 wireless networks. Wireless networks broadcast messages using radio, so are more susceptible to eavesdropping than wired networks. When introduced in 1999, WEP was intended to provide confidentiality comparable to that of a traditional wired network (Wikipedia).

WiFi

WiFi is an acronym for **W**ireless **F**idelity. It is meant to be used generically when referring of any type of 802.11 network, whether 802.11b, 802.11a, dual-band, etc. The term is promulgated by the Wi-Fi Alliance.

WPA

WPA is an acronym for **W**i-Fi **P**rotected **A**ccess. It was created in response to several serious weaknesses researchers had found in the previous system, Wired Equivalent Privacy (WEP). WPA implements the majority of the IEEE 802.11i standard, and was intended as an intermediate measure to take the place of WEP while 802.11i was prepared. WPA is specifically designed to also work with pre-WPA wireless network interface cards (through firmware upgrades), but not necessarily with first generation wireless access points. WPA2 implements the full standard, but will not work with some older network cards (Wikipedia).

WPA-PSK

WPA-PSK is an acronym for **W**i-Fi **P**rotected **A**ccess - **P**re **S**hared **K**ey. WPA was designed to enhance the security of wireless networks. There are two flavors of WPA: enterprise and personal. Enterprise is meant for use with an IEEE 802.1X authentication server, which distributes different keys to each user. Personal WPA utilizes less scalable

'pre-shared key' (PSK) mode, where every allowed computer is given the same passphrase. In PSK mode, security depends on the strength and secrecy of the passphrase. The design of WPA is based on a Draft 3 of the IEEE 802.11i standard (Wikipedia)

WPA-Radius

WPA-Radius is an acronym for **W**i-Fi **P**rotected **A**ccess - Radius (802.1X authentication server). WPA was designed to enhance the security of wireless networks. There are two flavors of WPA: enterprise and personal. Enterprise is meant for use with an IEEE 802.1X authentication server, which distributes different keys to each user. Personal WPA utilizes less scalable 'pre-shared key' (PSK) mode, where every allowed computer is given the same passphrase. In PSK mode, security depends on the strength and secrecy of the passphrase. The design of WPA is based on a Draft 3 of the IEEE 802.11i standard (Wikipedia)

WPS

WPS is an acronym for **W**i-Fi **P**rotected **S**etup. It is a standard for easy and secure establishment of a wireless home network. The goal of the WPS protocol is to simplify the process of connecting any home device to the wireless network (Wikipedia).

WTR

WTR is an acronym for **W**ait **T**o **R**estore. This is the time a fail on a resource has to be 'not active' before restoration back to this (previously failing) resource is done.

EC Declaration of Conformity

For the following equipment:

*Type of Product: IGS-10020MT

*Model Number: Industrial 8-Port 10/100/1000T + 2 100/1000X SFP Managed Switch

* Produced by:

Manufacturer's Name : **Planet Technology Corp.**

Manufacturer's Address: 10F., No.96, Minquan Rd., Xindian Dist.,
New Taipei City 231, Taiwan (R.O.C.).

is herewith confirmed to comply with the requirements set out in the Council Directive on the Approximation of the Laws of the Member States relating to Electromagnetic Compatibility Directive on (2004/108/EC).

For the evaluation regarding the EMC, the following standards were applied:

EN 55022	(2010, Class A)
EN 55024	(2010)
IEC 61000-4-2	(2008)
IEC 61000-4-3	(2006+A1:2007+A2:2010)
IEC 61000-4-4	(2004+A1:2010)
IEC 61000-4-5	(2005)
IEC 61000-4-6	(2008)
IEC 61000-4-8	(2009)

Responsible for marking this declaration if the:

Manufacturer Authorized representative established within the EU

Authorized representative established within the EU (if applicable):

Company Name: **Planet Technology Corp.**

Company Address: **10F., No.96, Minquan Rd., Xindian Dist., New Taipei City 231, Taiwan (R.O.C.)**

Person responsible for making this declaration

Name, Surname **Kent Kang**

Position / Title : **Product Manager**

Taiwan
Place

18 June, 2012
Date

Legal Signature

PLANET TECHNOLOGY CORPORATION

e-mail: sales@planet.com.tw http://www.planet.com.tw

10F., No.96, Minquan Rd., Xindian Dist., New Taipei City, Taiwan, R.O.C. Tel:886-2-2219-9518 Fax:886-2-2219-9528