



# AdderLink Digital iPEPS

## User Guide



[CONTENTS](#)

# Contents



## Introduction

AdderLink Digital iPEPS features.....	4
What's in the box .....	5
What you may additionally need .....	5



## Installation

Mounting .....	6
Connections .....	7
Host computer .....	7
IP network port.....	8
Power supply connection .....	9

## Configuration

Connecting to Digital iPEPS .....	10
Initial configuration .....	11
Performing a flash upgrade.....	12
Flash upgrade using the remote method .....	12
Flash upgrade using the dipswitch method .....	12

## Operation

Using the viewer window .....	13
The menu bar .....	13
When using the viewer window .....	13
Host selection.....	14
Configure.....	14
Auto calibrate  .....	15
Re-synchronise mouse  .....	15
Access mode - shared/private .....	15
Power switching.....	15
Editing the viewer window menu bar.....	16
Controls .....	17
Single Mouse Mode .....	17
Resync Mouse .....	17
Refresh Screen .....	17
Mouse Control.....	17
Advanced mouse configuration .....	18
Info.....	18
Keyboard Control.....	19
Video settings.....	19
Sound control .....	20
Virtual Media .....	21
Remotely transferring files as a virtual disk drive .....	21
Remotely exporting a disk drive to the host .....	22
Resetting the Digital iPEPS to factory default .....	23

INSTALLATION

CONFIGURATION

OPERATION

FURTHER INFORMATION

INDEX

# Further information

Getting assistance.....	24
Appendix 1 - VNC viewer connection options.....	25
Display .....	25
Inputs.....	26
Connection .....	27
Expert .....	27
Appendix 2 - VNC viewer window options.....	28
Appendix 3 - Java viewer options.....	29
Encoding and colour level.....	29
Inputs.....	29
Security .....	29
Misc.....	29
Appendix 4 - Configuration menus.....	30
User accounts .....	31
Gui edit configuration .....	32
Unit configuration .....	33
EDID configuration .....	34
Advanced unit configuration .....	35
Time & date configuration.....	36
Network configuration (IPV4).....	37
Network configuration (IPV6).....	38
Setting IP access control.....	39
Serial port configuration.....	40
Host configuration.....	41
Power switching configuration .....	42
Logging and status .....	43
LDAP configuration .....	44

Appendix 5 - Networking issues.....	45
Positioning Digital iPEPS in the network .....	45
Placing Digital iPEPS behind a router or firewall.....	45
Placing Digital iPEPS alongside the firewall .....	47
Appendix 6 - An introduction to IPv6 .....	48
Vastly increased address space.....	48
Standard subnet size .....	48
Address allocation .....	48
Mixing IPv4 and IPv6 .....	49
Appendix 7 - The KVMADMIN utility.....	50
Appendix 8 - Known working video modes .....	51
Appendix 9 - Product compatibility .....	51
Appendix 10 – Hotkey sequences and Adder Port Direct .....	52
Warranty .....	54
Safety information .....	54
End user licence agreement.....	55
Radio Frequency Energy.....	56

## Index



INSTALLATION
CONFIGURATION
OPERATION
FURTHER INFORMATION
INDEX

# Introduction

Drawing upon our long and successful history within the field of remote system control, we have taken our best *KVM via IP* technology and miniaturised it. The result is the AdderLink Digital iPEPS, a highly responsive, cost efficient way to control a single system from any remote position - worldwide.

*Digital iPEPS* stands for 'Digital **iP Engine Per Server**' and gives an indication of the clear design goals that have been applied to this product since its conception. In situations where a single system must be placed in a relatively isolated location and yet must be controlled from elsewhere, then Digital iPEPS is the solution. The host system can run its usual operating system completely unchanged and needs only to be connected to the compact Digital iPEPS unit. This ensures that there is no performance hit associated with other remote solutions and also provides the authorised remote user with complete control. The remote user uses a compact VNC viewer utility and can link to the Digital iPEPS via any connected IP network, or via the Internet.

### Adder Virtual Media feature

Allows an authorised remote user to transfer files and folders to a host computer, such that they appear as though presented locally on removable media (as would a memory stick or CD-ROM). Via the IP network link, the remote user can then control the host and make use of the transferred files and folders. An indispensable feature when remotely upgrading or patching distant host systems.

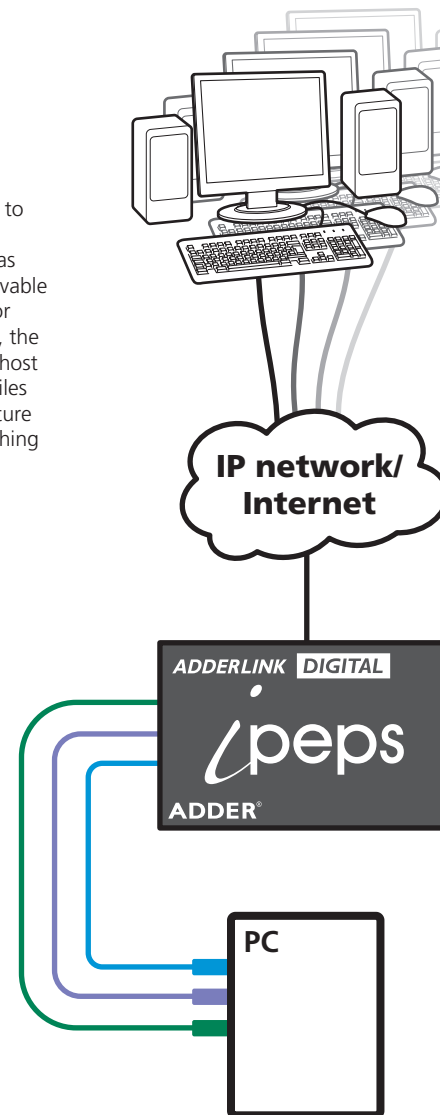

### Four simultaneous remote users

Digital iPEPS can support four remote users at any one time.

### IP network/Internet

The IP port allows direct connection to an Ethernet-based local network and from there onto the wider Internet, as required.

Alternatively, the robust Digital iPEPS security system will allow direct connection to the outside world.

INSTALLATION

CONFIGURATION

OPERATION

FURTHER INFORMATION

INDEX

# AdderLink Digital iPEPS features

The AdderLink Digital iPEPS unit uses the following connections to provide secure remote access to a host computer.



**USB link for keyboard and mouse**  
Use this port to link the Digital iPEPS to a USB port on the host computer. This will provide USB keyboard and mouse connections.

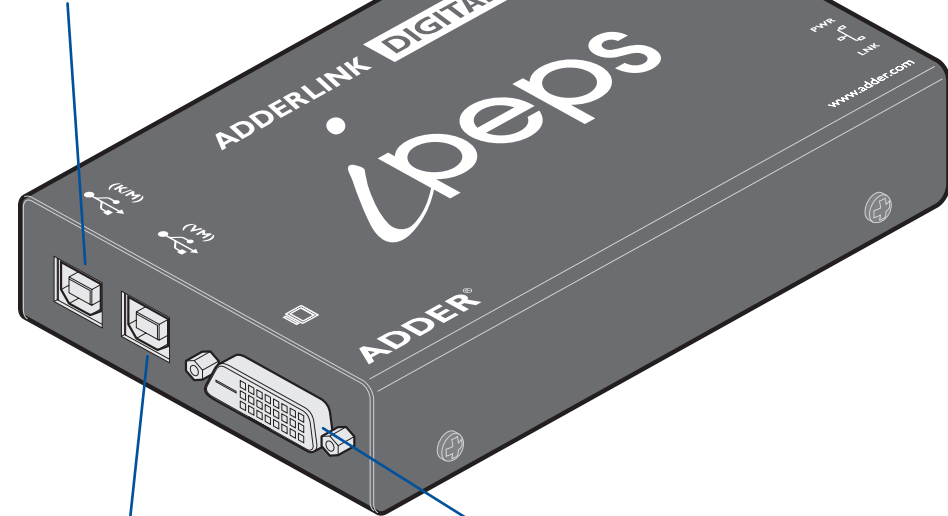

**USB link for the Adder Virtual Media feature**  
Optionally use this port to link the Digital iPEPS to a USB port on the host computer. This will provide a USB connection specifically for the Adder Virtual Media feature.

**Video input**  
DVI/D digital video input from the host computer.

**IP network port**  
This Ethernet port provides the connection to the network. The port is intelligent and can automatically sense whether it is attached to a 10Mb or 100Mb network and whether a cross-over or straight cable is in use. The green and yellow indicators provide useful status information.

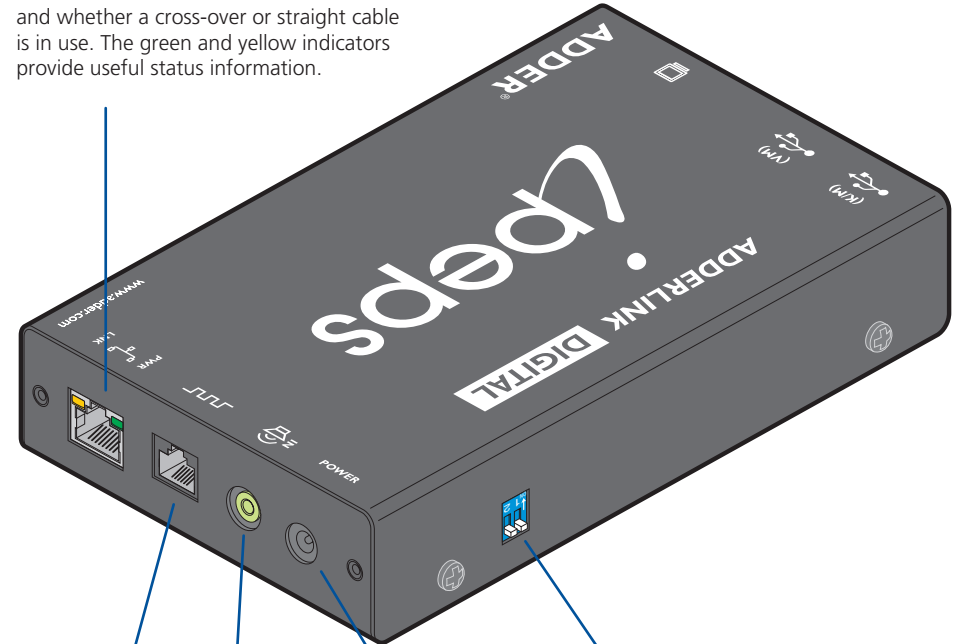

**RS232 serial input**  
Optionally use the supplied power control cable to link this port with the RS232 port of a power switch.

**Audio input**  
Optionally use the supplied 3.5mm jack cable to link this port with the audio output of the host computer.

**Power input**  
Connect the supplied power adapter here.

**Configuration switches**  
**SW1** is used to determine how Digital iPEPS derives its power. **SW2** is used to reset the Digital iPEPS back to its factory defaults. **SW2** is also used during firmware upgrades.

- INSTALLATION
- CONFIGURATION
- OPERATION
- FURTHER INFORMATION
- INDEX

## What's in the box

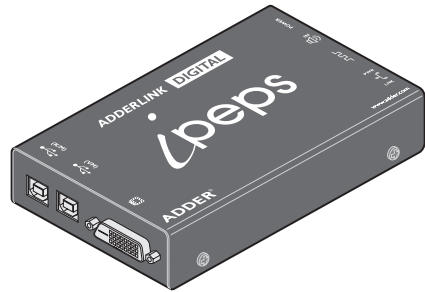

Digital iPEPS module

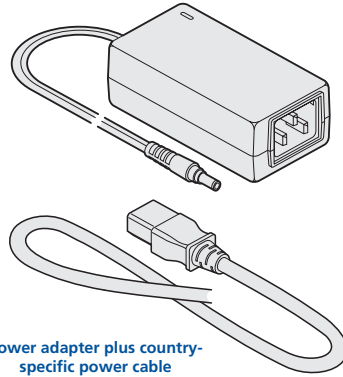

Power adapter plus country-specific power cable  
Part number: PSU-IEC-5VDC-2.5A

## What you may additionally need

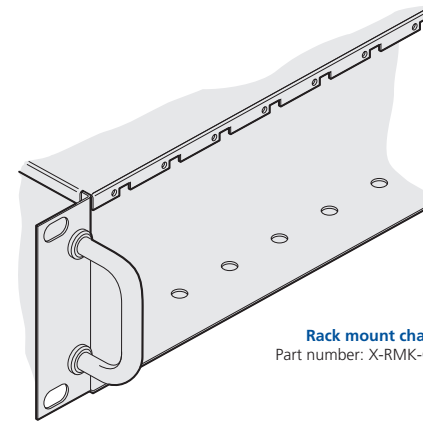

Rack mount chassis  
Part number: X-RMK-CHASSIS

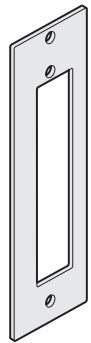

Rack chassis faceplate  
Part number: X-RMK-FASCIA

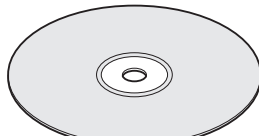

CD-ROM

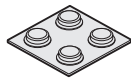

Four self-adhesive rubber feet

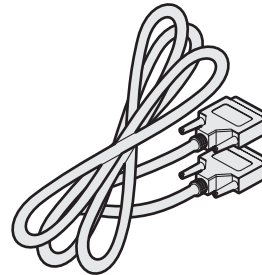

Video cable 2m DVI/D to DVI/D  
Part number: VSCD1

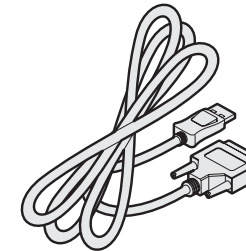

HDMI to DVI-D video cable  
Part number: VSCD11

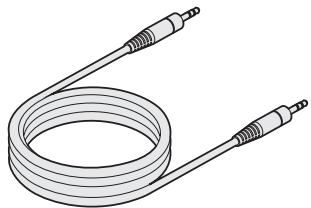

3.5mm jack stereo audio cable  
Part number: VSC22

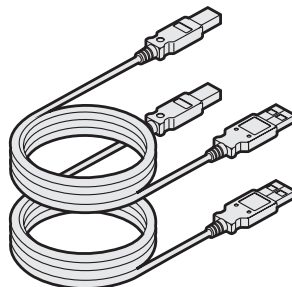

2 x USB cable 2m (type A to B)  
Part number: VSC24

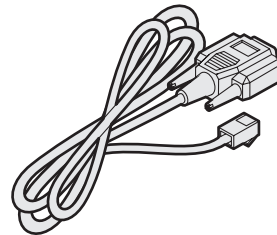

Power control cable  
Part number: VSC45



INSTALLATION

CONFIGURATION

OPERATION

FURTHER INFORMATION

INDEX

# Installation

## Mounting

The Digital iPEPS offers two main mounting methods:

- Supplied four self-adhesive rubber feet
- Rack chassis faceplate - see below

## Connections

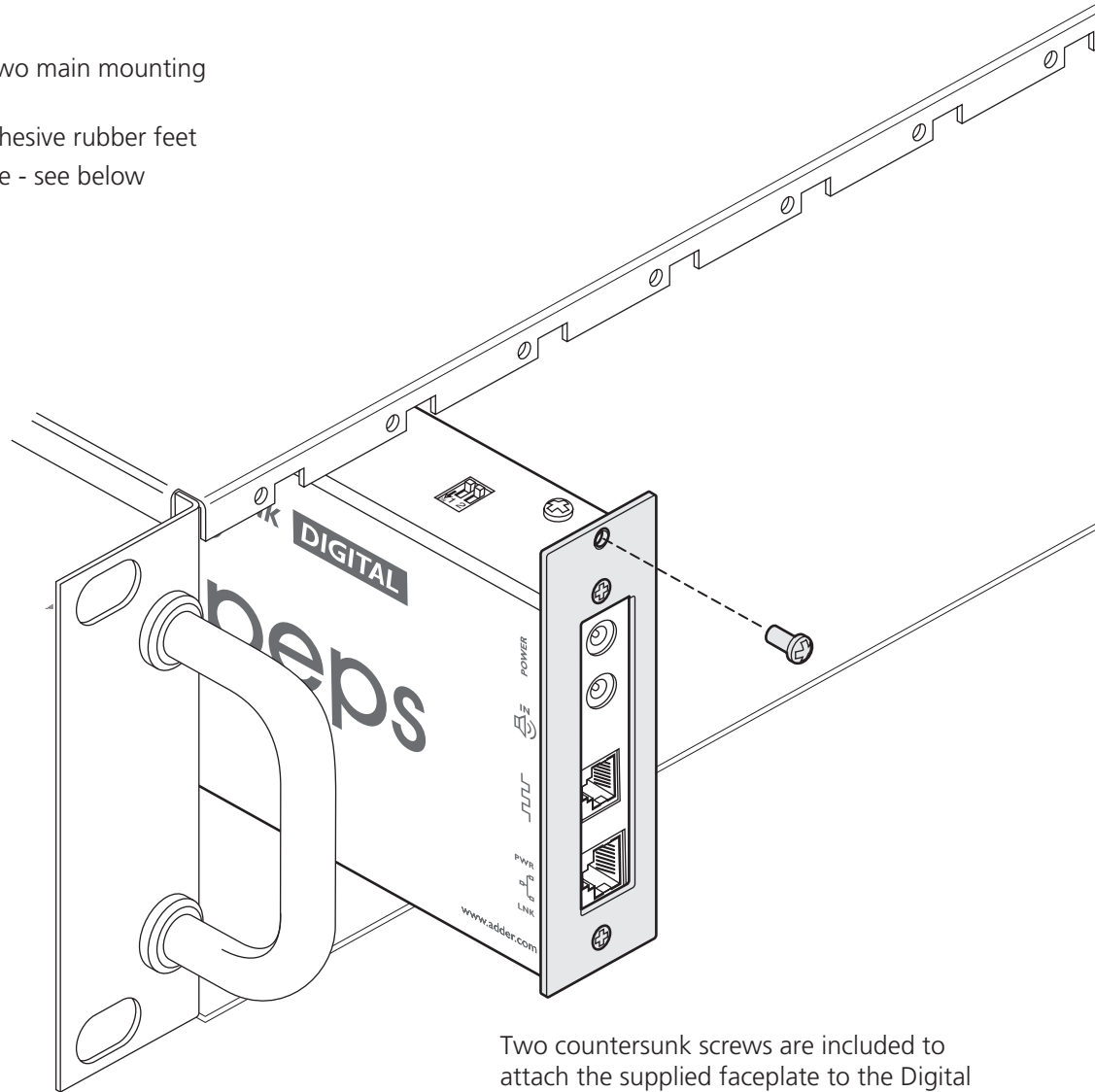

Two countersunk screws are included to attach the supplied faceplate to the Digital iPEPs unit and one panhead screw is provided to fix the faceplate to the rack chassis.

# Connections

Installation of the Digital iPEPS involves a number of basic connections to some or all of the following items:

- Host computer (below)
- [IP network port](#)
- [Power supply](#)

## Host computer

The Digital iPEPS is connected to the host computer using the supplied DVI-D video, USB, audio and power control cables (the latter two connections are optional).

### To attach the video and USB cables

- 1 Wherever possible, ensure that power is disconnected from the Digital iPEPS and the computer. Live connections are possible but it is also preferable to power down items before connection or disconnection.
- 2 Connect the supplied DVI-D cable to the video socket at one end of the Digital iPEPS and connect the other end to the video output of the host computer.
- 3 Connect one of the supplied USB cables to the socket labelled (K/M) and the other end to a vacant USB port on the host computer.
- 4 [Optional step] If the Adder Virtual Media feature is required and/or you wish to power the Digital iPEPS without using the supplied power adapter, then also connect the other supplied USB cable to the socket labelled (VM).

If the VM USB connection is not made then the supplied power adapter must be used.

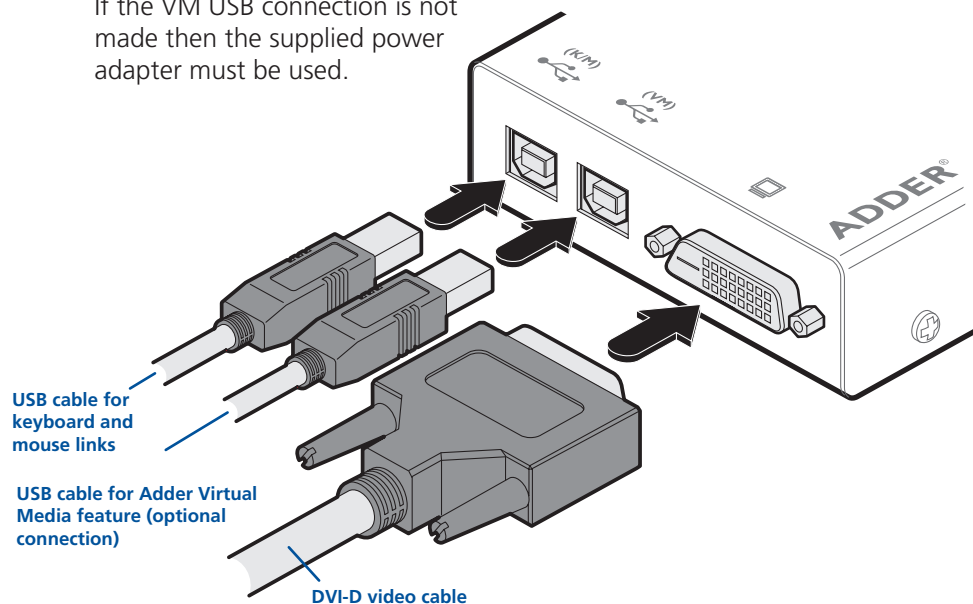

### To attach the audio and power control cables

- 1 [Optional step] Where audio from the host computer is required, connect the supplied 3.5mm jack stereo audio cable between the audio port (speaker icon) of the Digital iPEPS and the line output of the host computer.
- 2 [Optional step] Where a remote power switch is to be used with the host computer, connect the supplied power control cable to the socket labelled  on the Digital iPEPS. Connect the other end to the serial port of the remote power switch.

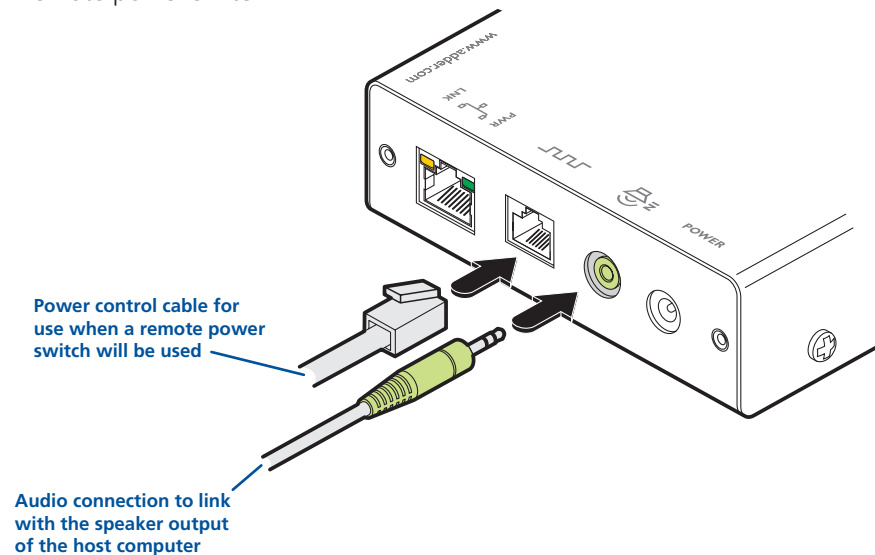

INSTALLATION

CONFIGURATION

OPERATION

FURTHER INFORMATION

INDEX



## IP network port

The Digital iPEPS provides an autosensing Ethernet IP port that can operate at 10 or 100Mbps, according to the network speed. The Digital iPEPS is designed to reside easily at any part of your network:

- It can be placed within the local network, behind any firewall/router connections to the Internet, or
- It can be placed externally to the local network, on a separate sub-network or with an open Internet connection.

Wherever in the network the Digital iPEPS is situated, you will need to determine certain configuration issues such as address allocation and/or firewall adjustment to allow correct operation. Please refer to [Networking issues](#) within the Configuration chapter for more details.

*IMPORTANT: When the Digital iPEPS is accessible from the public Internet, you must ensure that sufficient [security measures](#) are employed.*

### To connect the IP network port

- 1 Depending upon where in the network the Digital iPEPS is being connected, run a category 5e or 6 cable from the appropriate hub or router to the Digital iPEPS.
- 2 Connect the plug of the category 5e or 6 cable into the IP port on the end panel of the Digital iPEPS.

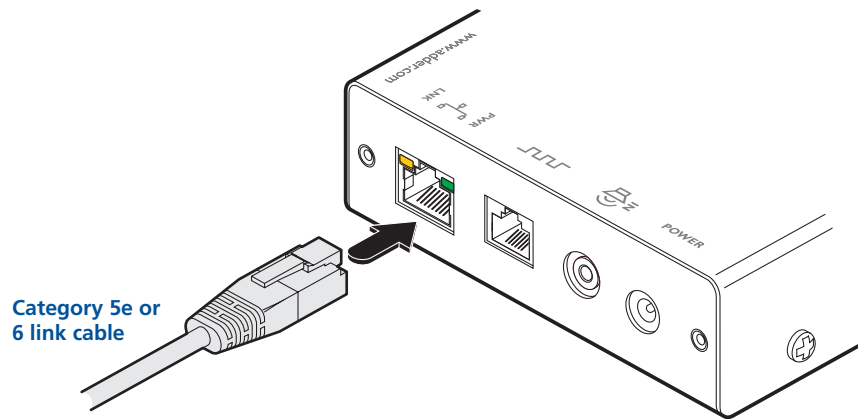

- 3 Configure the network settings as appropriate to the position of the Digital iPEPS within the network - see [Networking issues](#) for details.

## Power supply connection

The Digital iPEPS provides flexibility in the way that it is powered in order to suit your installation requirements. Each Digital iPEPS can be powered:

- Via both [USB connections](#) from the host computer, or
- From the supplied autosensing power adapter.

### Power supply issues and options

If you intend to derive power from the host computer then both USB connections must be made to the host computer. The Digital iPEPS will share its requirements between the two ports and will automatically refuse to operate if only one connection is made.

If you want to disable virtual media by omitting its USB cable, then you will need to use the supplied power adapter. On the side panel of the Digital iPEPS, use **switch 1** to determine how power should be derived:

<b>SW1</b>	OFF	Derive Digital iPEPS power from either the USB connections or the supplied power adapter.
	ON	Derive Digital iPEPS power only from the supplied power adapter.

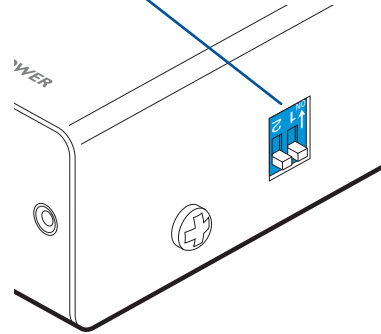

*Note: SW2 is used to reset the Digital iPEPS back to its [factory defaults](#) and is also used during [firmware upgrades](#).*

### To connect the power adapter

- 1 Connect the low voltage output connector from the power supply adapter to the power socket on the end panel of the Digital iPEPS.

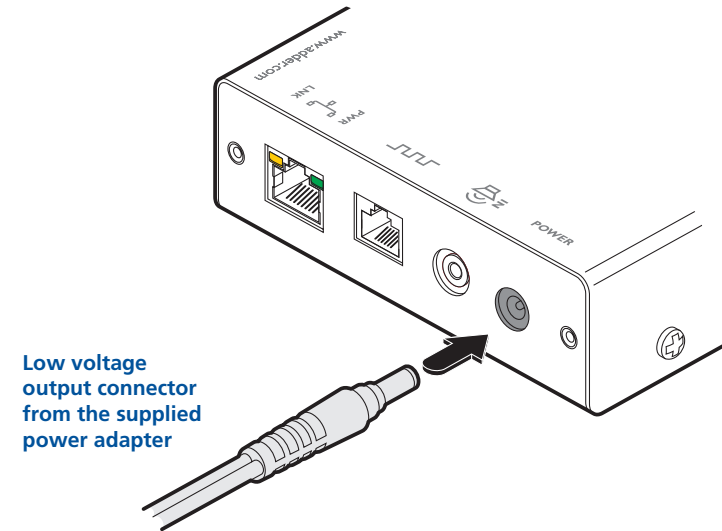

- 2 Connect the IEC connector of the supplied country-specific power lead to the socket of the power supply.
- 3 Connect the power lead to a nearby mains supply socket.

# Configuration

## Connecting to Digital iPEPS

Connection to (and configuration of) Digital iPEPS is carried out over a network, using a VNC Viewer program running on a computer or mobile device. VNC Viewers are available for most computers, tablets and smartphones.

- If you already have a VNC viewer, please follow the Initial configuration instructions given on the next page.

If you do not already have a VNC viewer, there are three options:

- You can download a Windows VNC Viewer from the Digital iPEPS itself.
- You can download the latest VNC Viewers for most operating systems via the RealVNC website, or for tablets and smartphones from the appropriate app store.
- Without downloading anything, you can run a Java version of the VNC Viewer inside your web browser.

### To download a Windows VNC Viewer from the Digital iPEPS unit

*Note: The version of VNC supplied within the Digital iPEPS supports audio, however, audio is not supported in the later viewers from RealVNC.*

- 1 Connect the Digital iPEPS to an IP network where a suitable computer is available on the same subnet (please see the Installation chapter for connection details).
- 2 On that computer, open an internet browser and enter the default local IP address used by the Digital iPEPS:

**http://192.168.1.42**

The Digital iPEPS welcome screen should be displayed:

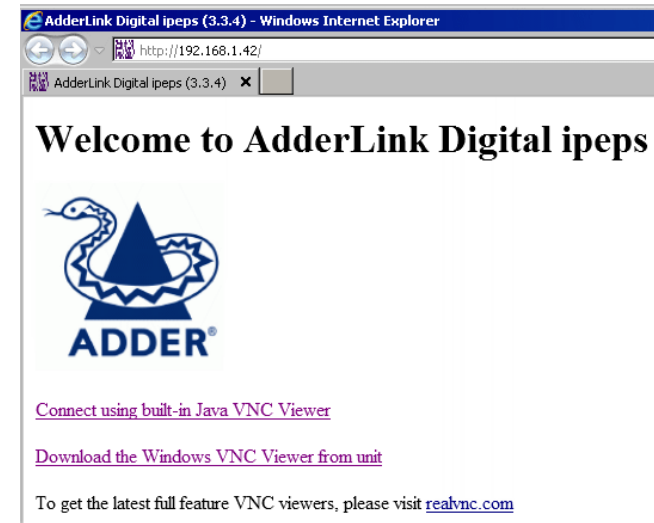

- 3 Click the link Download the Windows VNC Viewer from unit.
- 4 Once the file is downloaded, run it and follow the on screen instructions to open a VNC connection to the Digital iPEPS. (The VNC Viewer is a single executable file which does not require an 'installation' step. Simply put the file in a suitable place (such as the Desktop) and run it from there.)

### To download a VNC Viewer

To download a (free) VNC Viewer for a desktop or notebook computer, visit the download page of the RealVNC website:

<http://www.realvnc.com/download/viewer>

To download a VNC Viewer app for a tablet or smartphone, visit the Apple or Android app store, or look at the RealVNC website ([www.realvnc.com](http://www.realvnc.com)) for further information.

### To use the Java VNC Viewer

- 1 Connect the Digital iPEPS to an IP network where a suitable computer is available on the same subnet (please see the Installation chapter for connection details).
- 2 On that computer, open an internet browser and enter the default IP address used by the Digital iPEPS:

**http://192.168.1.42**

The Digital iPEPS welcome screen should be displayed (as shown above).

- 3 Click the link Connect using built-in Java VNC Viewer. The Java viewer will load and run inside the browser. For more details see [Appendix 3 - Java viewer options](#).



INSTALLATION

CONFIGURATION

OPERATION

FURTHER INFORMATION

INDEX

# Initial configuration

To perform the initial configuration, you need to connect the Digital iPEPS to an IP network and use a computer located on the same network to connect to it.

## To perform the initial configuration

- 1 Connect the Digital iPEPS to an IP network where a suitable computer is available on the same subnet (please see the [Installation chapter](#) for connection details).

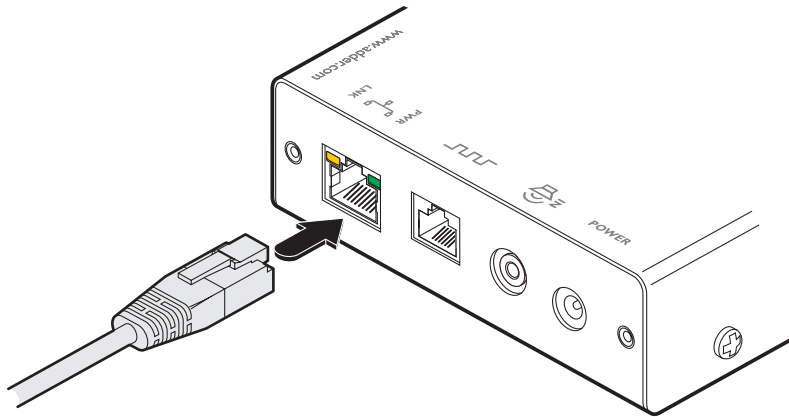

- 2 Use a computer connected to the same subnet of the network. On that computer, locate and select the VNC viewer icon ⇒  
A connection details dialogue will be displayed:

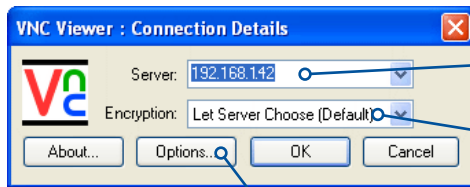

Enter the Digital iPEPS address here and click OK

If required, select the encryption mode

Options button

Provides a range of viewer and connection settings - [MORE \[+\]](#)

- 3 In the 'Server:' entry, type the address: **192.168.1.42**

- 4 Click the OK button. The viewer window may open straight away (if so continue at step 6) or the system may require user authentication in which case an authentication dialogue will be displayed:

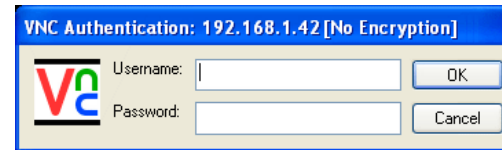

- 5 Enter **admin** as the Username, leave the password entry blank and click the OK button. The viewer window should now open:

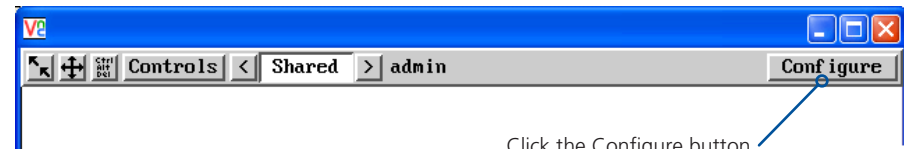

Click the Configure button

- 6 Click the Configure button to display the Configuration menu:

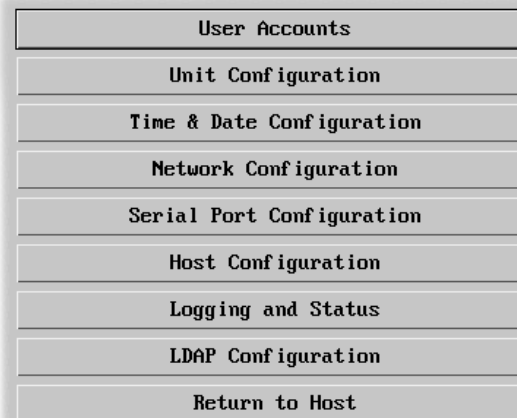

Use the various options (particularly the 'Unit Configuration' and 'Network Configuration' options) to arrange the Digital iPEPS to suit your requirements.

See [Appendix 4 - Configuration menus](#).

## Performing a flash upgrade

The firmware in Digital iPEPS is fully upgradable and there are two methods that you can use:

- The remote method, or
- The 'dip switch' method.

The most streamlined upgrade procedure is the remote method because it is carried out completely from a remote system. The 'dip switch' method is useful because it can be carried out even if the firmware within the Digital iPEPS unit has been corrupted.

### Flash upgrade using the remote method

Using this method, the Digital iPEPS is upgraded via remote connection (through the IP network port). Upgrades are digitally signed by Adder using a secure key. This prevents unauthorised or altered firmware images being downloaded into the unit.

#### To perform a flash upgrade

- 1 Download the latest firmware revision for the Digital iPEPS from the Adder website and decompress the download file. View the decompressed files and make a note of the name and location of the .bin file that was part of the download file collection.
- 2 Make a remote connection to the Digital iPEPS unit and login as the admin user.
- 3 Once logged in, click the 'Configure' button in the top right corner of the window.
- 4 Click the 'Unit Configuration' button.
- 5 Click the 'Advanced Unit Configuration' button.
- 6 Click the 'Upgrade Firmware' button. A dialogue box will be displayed:

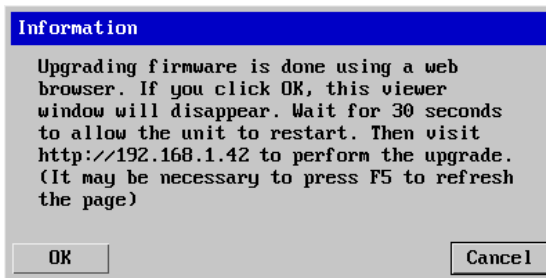

- 7 Note the IP address shown in the dialogue box and click OK.

- 8 The unit is now ready to accept the upgrade files. Open your browser and log into the Digital iPEPS using the IP address that was confirmed in the dialog. Once connected, the unit will offer the following screen:

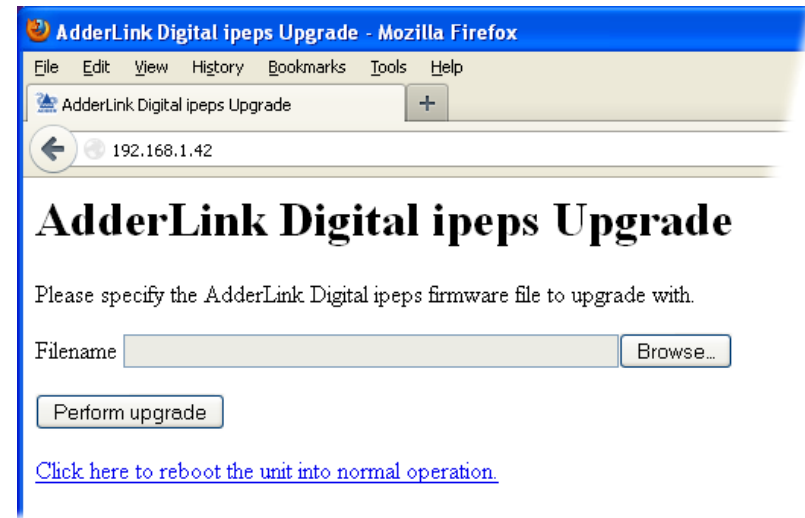

- 9 Click the 'Browse' button and locate the .bin upgrade file that you downloaded earlier. Click the 'Perform Upgrade' button. The upgrade will take place and its progress will be shown on screen.
- 10 When the upgrade is complete, click the link 'Click here to reboot the unit into normal operation'.

### Flash upgrade using the dipswitch method

Use the dipswitch method if the firmware on the Digital iPEPS has become corrupted and there is no access from a VNC session. You will need to know the IP address of the Digital iPEPS (the default IP is 192.168.1.42).

- 1 With the power off, change dip switch 2 to ON.
- 2 Power On the Digital iPEPS.
- 3 Using a web browser go to the IP address of the Digital iPEPS. You should see the upgrade page as shown above.
- 4 Browse to the .bin file and then click the Perform upgrade button.

# Operation

## Using the viewer window

Once connected to the Digital iPEPS via the VNC Viewer (please see [Connecting to Digital iPEPS](#) for details), the viewer window gives you the ability to view and control the Digital iPEPS and its host computer(s). Its operation is almost identical regardless of whether you used the VNC viewer or your Java viewer to display it.

### The menu bar

The viewer window presents a menu bar similar to that shown below. Certain items within the toolbar are displayed depending upon your access permissions and/or the Digital iPEPS configuration.

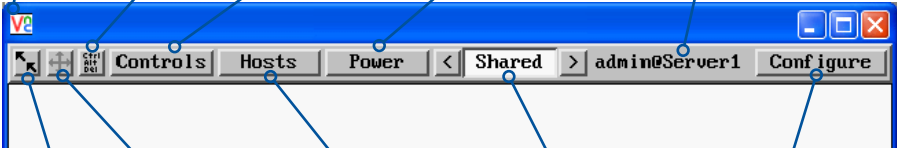

**Viewer options** (VNC viewer only) Click the VNC icon to view the viewer window options.

**Ctrl Alt Del** Sends the Ctrl Alt Del sequence to the current host computer.

**Controls** Displays a menu of options concerning keyboard, video and mouse operation.

**Power** Click to access the power on/off options for the current host computer.

**Dialogue area** Indicates your username and the host system that you are currently viewing. This area can also display other messages.

**Re-sync mouse** Ensures that the mouse pointer which you move and the mouse pointer on the host system are correctly synchronised.

**Auto calibrate** This button will calibrate the mouse, but only when relative mouse mode is selected.

**Hosts** Click to display a list of computers. Choose an entry to connect to that host computer.

**Access mode** Allows you to choose between Shared and Private access modes.

**Configure** This option is only available to the admin user and provides access to the main configuration menus.

*Note: During initial use, neither the Hosts nor the Power buttons will be present.*

For details about how to determine the options on the menu bar, see [Editing the viewer window menu bar](#).

## When using the viewer window

### What is the best screen resolution to use?

The best resolution for your computer is one that is larger than the screen of the host computer that you are viewing. This will allow you to see everything without scrolling around. Alternatively, the VNC viewer can be set to scale the image to fit your screen, but remember that some pixel dithering effect will be seen when scaling is used.

### How do I navigate around a larger screen?

If the screen that you are viewing has a larger resolution than your viewing window you will need to scroll around to see all items. The viewer window allows you to 'bump scroll' (only in full screen mode). This means that when your mouse cursor bumps against the edge of the screen, the screen image will scroll across automatically.

### How do I escape from full screen mode?

Press the F8 button. This button is changeable but is most often set to F8.

### How do I make the most of a slow connection?

The VNC viewer is slightly better suited to slower connections than the browser viewer because it offers more options. Click the [Options](#) button of the VNC viewer when entering the Digital iPEPS address during log on.

### Rate limit mouse events

When selected, this mode greatly reduces the mouse movement data that are sent to the host computer. When you move the local mouse, the remote cursor will catch up roughly once per second.

## Host selection

The Hosts button on the menu bar provides the quickest and most efficient way to switch between host computers. This is because the button is close at hand, but also because the screen calibration details for each host are reused when this method of switching is used.

*Note: The Hosts button is displayed only when the switching details for two or more computers have been declared within the configuration section by the admin user.*

### To select a host

- 1 Click the **Hosts** button to display a list of computers.
- 2 Click the required computer name to view and control it.

See [Host configuration](#) for details about programming new hosts into the Digital iPEPS ('admin' user status required).

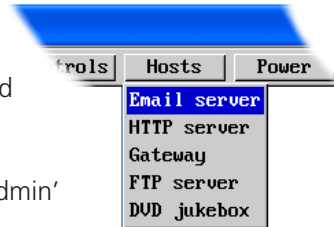

## Configure

This option is displayed only when you are logged on as the 'admin' user. When selected it provides access to a wide range of Digital iPEPS settings.

See [Appendix 4](#) for more details.

## Auto calibrate

Auto calibrate will calibrate the mouse only if relative mouse mode is selected. This detects the mouse motion and will report back that the mouse has been calibrated correctly depending upon the operating system.

See the notes on [Advanced mouse configuration](#) for more details.

Once this has been done, providing you use the 'Hosts' button to switch between host computers, the video settings for each machine will be re-used.

## Re-synchronise mouse

If you find that your local mouse pointer and that of the host are not correctly synchronised, use this feature to re-align their movements. This operation is also selectable from the Controls menu.

### To re-synchronise the mouse

- 1 Use the Hosts button to select the required computer.
- 2 Click the  button and then click OK in the subsequent pop-up message.

*Note: If you find that this doesn't work, you may need to perform a mouse calibration again.*

## Access mode - shared/private

Up to four users can be simultaneously logged-in and all will view the same host. If you need to perform a sensitive task that should not be viewed by other users, you can change the access mode to Private. This action prevents other users connecting at the same time.

### To change the access mode

- 1 Click one of the arrow buttons adjacent to the Shared/Private indicator.



## Power switching

When configured (and where you have access rights) this option allows you to control the mains power input to the currently selected host computer.

*Note: This option is generally used to power cycle remote systems that have failed to respond. Before switching a system off, ensure that all attempts have first been made to power it down through normal means.*

### To switch a system on or off

- 1 Use the Hosts button to select the required computer.
- 2 Click the Power button and then select the Switch on or Switch off option, as appropriate.

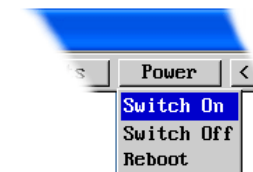



## Editing the viewer window menu bar

If required, you can customise the menu bar of the viewer window to ensure that it contains only the necessary options.

The menu bar can be edited locally by each user or edited singly by the admin or alternatively, the admin can globally alter the menu bar for all users.

### To edit the menu bar locally

- 1 Login remotely via VNC viewer and display the viewer window.
- 2 Place the mouse pointer on the menu bar and click the right mouse button. A popup will be displayed:



- 3 Click on any option within the popup to add it to or remove it from the menu bar.
- 4 When all changes have been made, click anywhere else within the viewer window.

Changes made in this way will affect the individual user only.

Note: The local menu bar edit popup shown above will only appear if the *Enable direct right click Menu editing* option is ticked within the Gui Edit Configuration screen (for that user) as shown right.

### To edit the menu bar via admin

- 1 Login remotely via VNC viewer as admin user and display the viewer window.
- 2 Click the *Configure* button in the top right corner of the viewer window.
- 3 Click the *User Accounts* button.
- 4 Against the entry for the required user, click the Menu Bar **Edit** button. The following dialogue will be displayed:

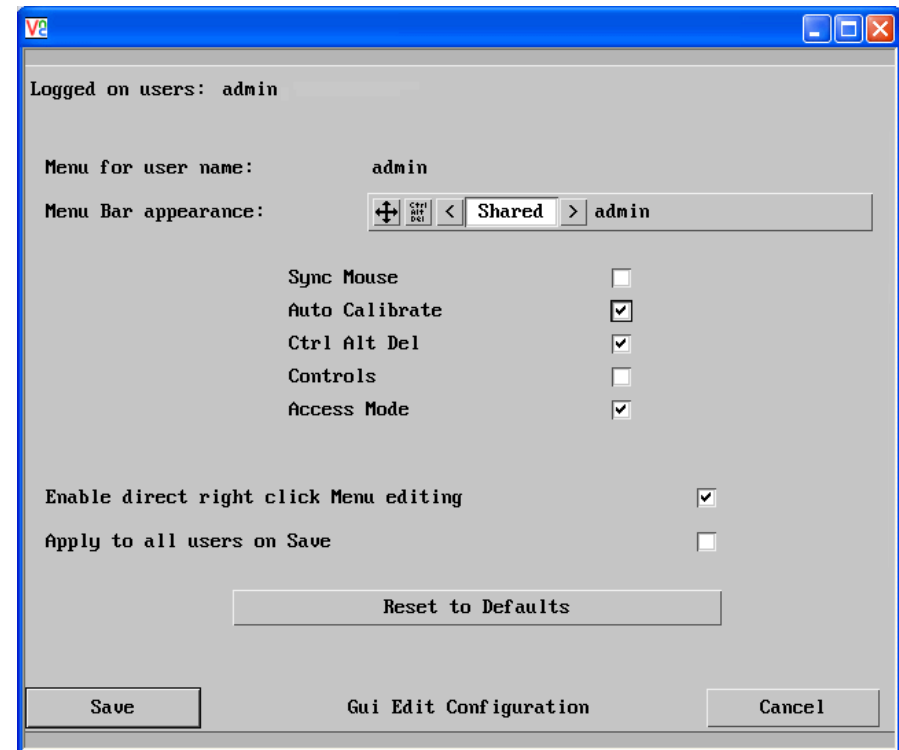

- 5 Select/deselect the items that you wish to appear on the menu bar. As you do so, the *Menu bar appearance* image will show how the bar will look using your edited settings.
- 6 Optional: To globally apply your changes, tick the *Apply to all users on Save* option.
- 7 Click the **Save** button.

## Controls

When clicked, this button reveals a menu of options concerned with keyboard, video and mouse operation.

### Single Mouse Mode

This mode is for fast network connections where the cursor response is sufficient to provide instant visual feedback on the remote screen. When enabled, the cursor is 'captured' within the viewer window until you use the 'escape' hot keys.

To quit from single mouse mode, press F8 and then P. Alternatively, enable and use the mouse button escape sequences - see [Advanced unit configuration](#) for details.

The single mouse mode does not require calibration.

### Resync Mouse

This option has the same effect as the  button on the menu bar and re-synchronises the local and remote mouse pointers.

### Refresh Screen

This option refreshes the whole screen image to remove any artefacts from moved screen items. This is useful when using very low refresh rates on slow speed communication links.



## Mouse Control

This option displays a mouse control dialogue and is useful when the remote cursor is failing to respond correctly to your mouse movements, even after using the Resync mouse option.

The mouse control dialogue allows you to control the remote mouse cursor using a selection of buttons that you click with your local mouse.

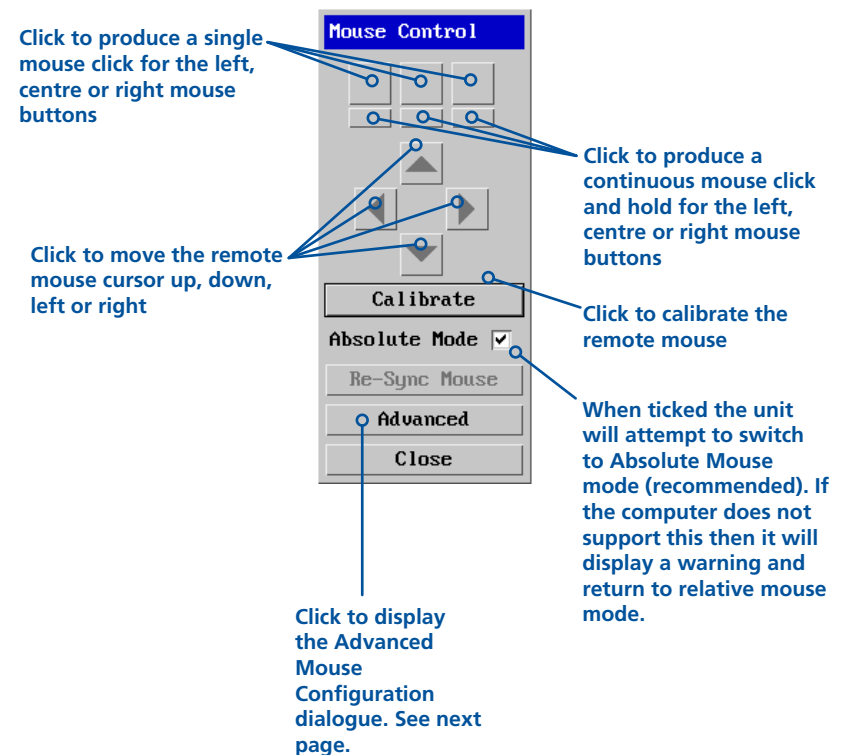

## Advanced mouse configuration

This dialogue allows the mouse acceleration to be configured according to the operating system in use and also permits manual fine tuning for situations where problems are encountered with the Calibrate function.

For best results, choose the appropriate *Change motion*: entry to match the host in use.

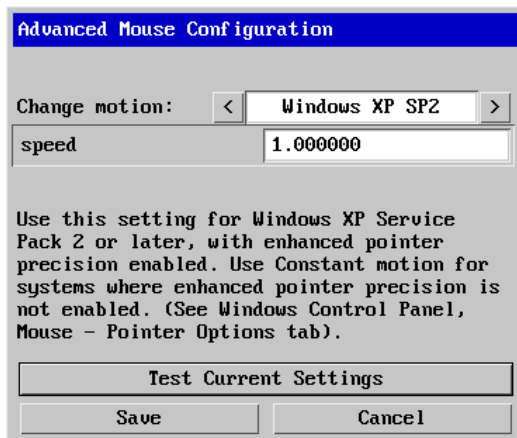

The available Change Motion schemes are: *Constant*, *XFree86*, *Windows Pre-XP*, *Windows XP*, *Windows XP SP2*, *OS/2*, *Solaris*, *Solaris 9* and *Mac OSX*. Most of these offer the Speed setting as the only option, however, the *Windows Pre-Xp* and *XFree86* options contain many other parameters.

When the *Absolute Mode* option is ticked in the main [Mouse Control](#) menu, this dialogue allows you to adjust the *Absolute Offset* scale:

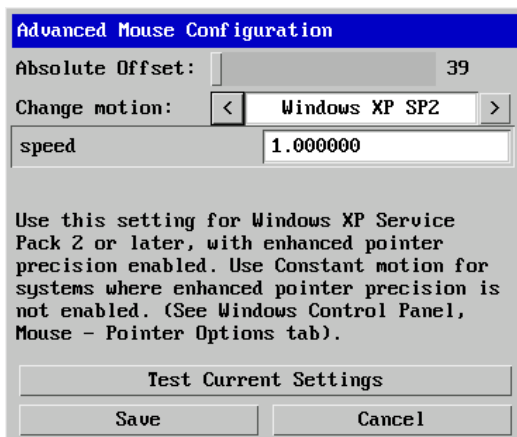

## Info

When selected, this option displays an information dialogue showing the current logged on users, the current host, its video mode and its mouse motion details.

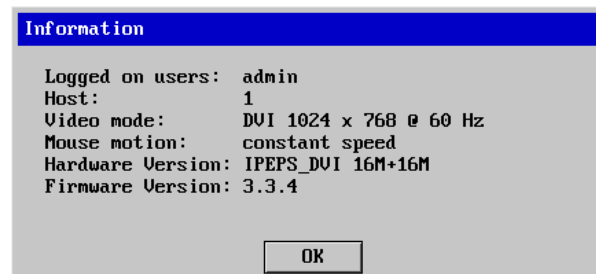

INSTALLATION

CONFIGURATION

OPERATION

FURTHER INFORMATION

INDEX

## Keyboard Control

This option displays a keyboard control dialogue and is useful for sending keyboard combinations (to the host) that are needed regularly or that are trapped by the Digital iPEPS.

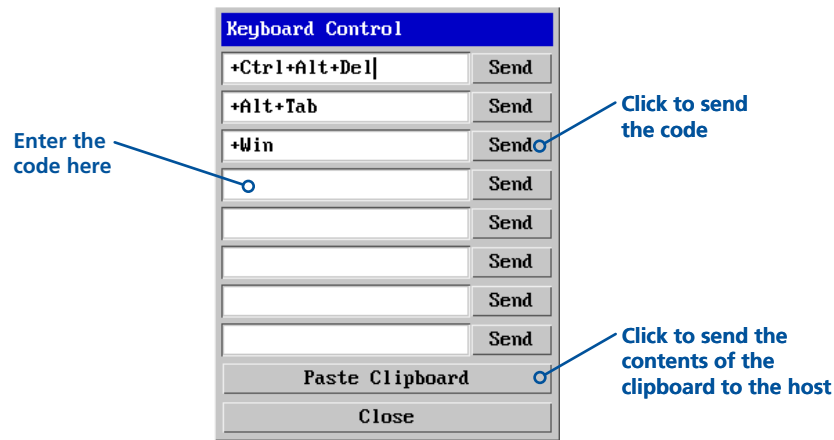

When entering codes:

- + means press down the key that follows
- means release the key that follows
- +- means press down and release the key that follows
- \* means wait 250ms (note: if a number immediately follows the asterisk, then the delay will equal the number, in milliseconds)

It is automatically assumed that all keys specified will be released at the end, so there is need to specify -Ctrl or -Alt if these keys are to be released together.

Examples:

- 'Ctrl + Alt 12' would be expressed as: +Ctrl+ Alt+1-1+2
- +N means press the 'N' key
- +Scroll means press the Scroll lock key
- +Space means press the space key

Note: If using the *Paste Clipboard* feature, within the VNC viewer properties, ensure that in the **Inputs** section, the **Share clipboard with server** option is enabled. See [Appendix 1](#) for details.

## Video settings

This option provides a range of options related to the video configuration.

Dithering is a technique used by some graphics cards to improve perceived image quality by continuously slightly varying the colour of each pixel. This gives the illusion of more shades of colour than the display can really reproduce, and smooths the appearance of gradually shaded areas in images. Unfortunately, dithering is an issue for KVM extenders such as Digital iPEPS because it makes the image appear to be changing all the time even when it is static. This means that a great deal of unnecessary network data is sent to the VNC viewer, reducing the video frame rate and making mouse response appear slow.

The **Ignore Dithering** option works by ignoring small variations in the video from frame to frame. It is disabled by default to give full colour accuracy and the best possible frame rate from non-dithered video sources.

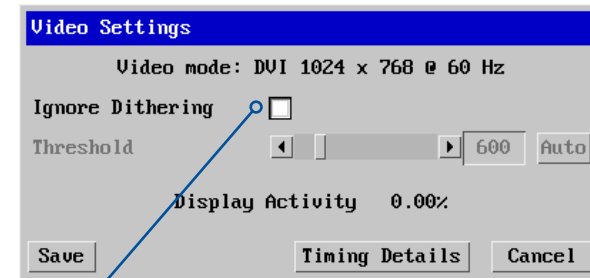

### Ignore Dithering

The 'Ignore Dithering' option increases performance and reduces network traffic when the host computer is an Apple Mac or another computer that has dithered video output. It also improves performance if the video source is noisy (e.g. from a camera or a VGA-to-DVI converter).

The **Threshold** setting adjusts the level of dithering noise that is ignored. The 'Auto' button attempts to choose a suitable value automatically, but the level can also be adjusted manually using the slider or arrow buttons. The best value is of course a compromise between capturing all the 'real' screen changes whilst ignoring the (almost invisible) dithering noise. A good way to choose the value is to watch the **Display Activity** indicator for a static screen. If the Threshold is too low, the Display Activity will be a high percentage while nothing is really changing. If the Threshold is too high, the Display Activity will be very low (or zero) but some real changes in the screen may be missed.

## Sound control

This option provides a range of options related to the audio capabilities of the Digital iPEPS.

### Sample rate

The number of audio samples per second (in Hz). 8000 produces less samples and hence uses less network bandwidth. 48000 (48KHz) produces the best sound reproduction.

### Channels

Allows you to choose between Mono and Stereo.

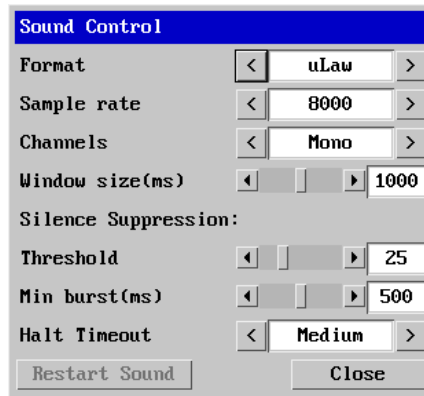

### Format

**uLaw** - Use when transmitted data needs to be minimised - 8-bit compressed data.

**Linear** - Use when high quality audio performance is required - 16-bit uncompressed (raw) data is transmitted.

### Window size (ms)

The time frame in which the unit requires an acknowledgement from the remote viewer when data is sent. If acknowledgements are not received, the unit will stop sending audio data - Click the Restart Sound button.

### Restart Sound

Click to re-enable audio transmission following an automatic cutout. If cutouts occur regularly, try reducing the sample rate or format, or increasing the Window size setting.

### Threshold

The level above which the audio level should be before it is considered to be not background noise and hence should be transmitted. A level of 25 means the audio input needs to be above 25% of the maximum before it is transmitted.

### Halt timeout

Determines how long to wait once the audio input has stopped before timing out the audio connection. There are four options: Off, Short, Medium and Long.

### Min burst (ms)

The time period for which the audio input must fall below the threshold level before audio transmission ceases. Transmission will begin again as soon as the threshold level is once again exceeded.

Settings can be adjusted to suit transmission characteristics and audio quality requirements (unsuitable audio settings can affect video quality):

### For use on slow links:

Format: uLaw  
Sample rate: 8000  
Channels: Mono

### For maximum audio quality:

Format: Linear  
Sample rate: 48000  
Channels: Stereo

Where necessary, adjust the Window size, Threshold and Min burst settings until optimum audio output is obtained.

## Virtual Media

The Adder Virtual Media feature allows you to remotely make files available to a host computer that is linked to the Digital iPEPS. Disk drives, single files or collections of files and folders up to 2GB in size can be mounted via the VNC link, and appear as a read-only disk on the host. This can prove to be an invaluable tool when upgrading host computers from remote positions.

*Note: The file transfer is in one direction only, from viewer to host.*

*Note: Adder Virtual Media does not currently work with Apple Mac systems.*

In order to use the Adder Virtual Media feature, the VM link must be made between the Digital iPEPS and a USB port on the host computer. See [Host computer connections](#) for details.

There are two main ways to use Adder Virtual Media:

- Create a read-only 'virtual disk drive' on the host from one or more files chosen at the viewer end. This is useful for copying one or more files from the computer running the VNC viewer to the host computer. See below.
- Export a disk drive (e.g. CD, DVD or USB flash drive) from the viewer computer so it appears as a disk on the host attached to Digital iPEPS. A particular use for this is for booting or upgrading the remote host from a CD or other media that you have at the viewer end. See [next page](#).

### Remotely transferring files to the host as a virtual disk drive

There are several methods of doing this. The easiest method depends on whether:

- The files are already on the clipboard of the viewer computer (following an *Edit -> Copy* operation). See *To remotely transfer files from the clipboard >>*
- or
- The files still need to be selected. See *To select and remotely transfer files from the viewer computer >>*

*Note: When using Adder Virtual Media features, within the VNC viewer properties, ensure that in the **Inputs** section, the **Share clipboard with server** and the **Enable file transfer** options are enabled. See [Appendix 1](#) for details.*

### To remotely transfer files from the clipboard

- 1 On the remote system, log into the Digital iPEPS using the VNC viewer.
- 2 If not already done, use Windows Explorer to locate and copy the required file(s), or folder(s) to the clipboard.
- 3 Within the VNC viewer window, click the *Controls* button and then select the *Virtual Media* option. A popup similar to the following will be displayed:

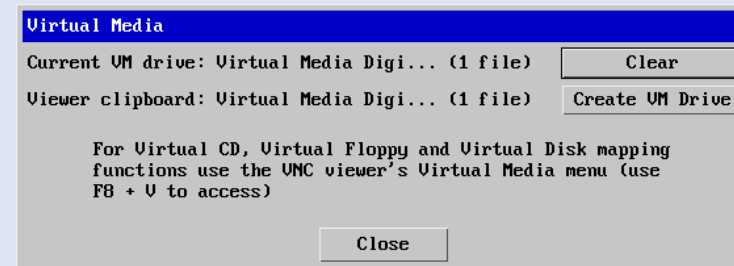

Click the *Create VM Drive* button to announce file availability to the host computer, whereupon a popup will confirm that the new virtual media disk is built.

*Note: Remember, at this point the selected files/folders have not yet been transferred to the host system, they are just visible there.*

- 4 On the host computer (via the VNC viewer) locate the new virtual drive (shown as a *Removable Disk*) and copy the files to the required location on the host computer.

### To select and remotely transfer files from the viewer computer

- 1 On the remote system, log into the Digital iPEPS using the VNC viewer.
- 2 Invoke the "Send Files" feature of the VNC viewer (called "File Transfer" in later versions), either by clicking the icon on the viewer's toolbar or selecting from the F8 menu.
- 3 The viewer will display a window allowing you to select files or a whole folder. Highlight the required files or folders (up to a maximum of 2GB) that you wish to transfer to the host computer and click the *Open* button. The new disk drive should appear on the host a few seconds later.

*Note: The Use Entire Folder button provides a quick way to select a whole folder while you are viewing its contents.*

*Note: Remember, at this point the selected files/folders have not yet been transferred to the host system, they are just visible there.*

- 4 On the host computer (via the VNC viewer) locate the new virtual drive (shown as a *Removable Disk*) and copy the files to the required location on the host computer.



## Remotely exporting a disk drive to the host

- 1 On the remote system, log into the Digital iPEPS using the VNC viewer.
- 2 Press **F8** and then **V** to display a *Virtual Media* dialogue box:

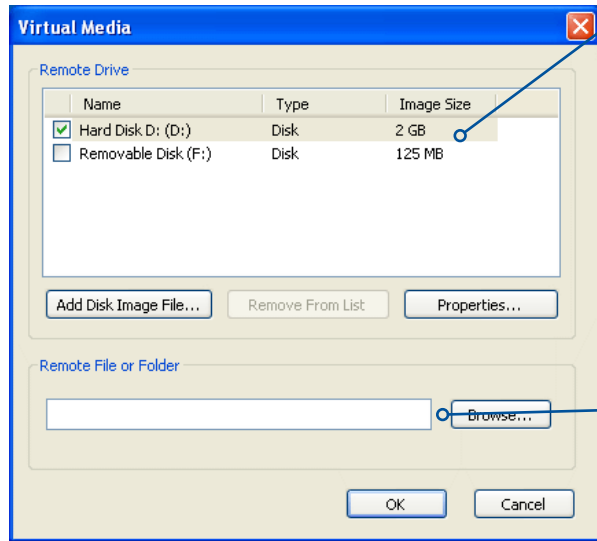

### Remote Drive(s)

This section lists any located storage devices on the remote system that are 2GB or less, and which could be copied en masse to the host computer, if desired.

When the **Create ISO Image** option is ticked this creates a bootable disk so that it's possible to boot the host computer from the virtual media drive.

### Remote Files or Folders

Click Browse to search for and select single or multiple files/folders to be copied to the host computer.

- 3 You can select an entire drive or a disk image (e.g. .iso) file:
  - Select a disk drive: Click the checkbox adjacent to the listed disk drive that you wish to make available to the host computer,
  - or
  - Add a Disk Image File: Select the disk image file and click **Open**.
- 4 In the *Virtual Media* dialogue box, click the OK button to announce the availability of the drive to the host computer. On the host computer, the new drive will appear in the same way as any removable drive would on your computer.

*Note: Remember, at this point the selected drive has not yet been transferred to the host system, it is just visible there.*

- 5 On the host computer (either directly from Digital iPEPS local console or via the VNC viewer) locate the new virtual drive (shown as a Removable Disk) and copy the files to the required location on the host computer.

*Note: The Remote File or Folder section of this Virtual Media dialogue box provides yet another method of creating a virtual drive from some files or folders, as described above.*

## Resetting the Digital iPEPS to factory default

For situations where the IP address or the password has been forgotten, or the Digital iPEPS is being reinstalled, it is possible to reset the unit to its original factory settings. This erases all configuration such as hosts, users and passwords, and restores the default network address.

### To perform a factory reset:

- 1 Disconnect the power, USB and video cables from the Digital iPEPS unit. Leave the network cable plugged in and use it to link the Digital iPEPS unit to a network.
- 2 Set Configuration Switch 2 to the ON (up) position.
- 3 Apply power to the unit (either from the power supply or via both USB cables).
- 4 Leave Switch 2 in the ON (up) position until the orange indicator illuminates, at which point, immediately set Switch 2 to the OFF (down) position.  
If the factory reset is successful, the orange indicator will flash off once after fifteen seconds.  
After the factory reset is complete, the unit will reboot and you can connect a VNC viewer to it using the default IP address: 192.168.1.42 to check that the configuration has been reset.

*Note: If the factory reset is unsuccessful, power down the Digital iPEPS unit and try again.*



# Further information

This chapter contains a variety of information, including the following:

- Getting assistance - see right
- Appendices
- [Safety information](#)
- [Warranty](#)
- [End user licence agreement](#)
- [Radio frequency energy statements](#)

## Getting assistance

If you are still experiencing problems after checking the information contained within this guide, then we provide a number of other solutions:

- **Online solutions and updates** – [www.adder.com/support](http://www.adder.com/support)  
Check the Support section of the adder.com website for the latest solutions and firmware updates.
- **Adder Forum** – [forum.adder.com](http://forum.adder.com)  
Use our forum to access FAQs and discussions.
- **Technical support** – [www.adder.com/contact-support-form](http://www.adder.com/contact-support-form)  
For technical support, use the contact form in the Support section of the adder.com website - your regional office will then get in contact with you.



INSTALLATION

CONFIGURATION

OPERATION

FURTHER  
INFORMATION

INDEX

# Appendix 1 - VNC viewer connection options

Note: If you are using a later version of VNC viewer than that provided with the product originally, some menus may differ slightly from those shown here.

When you are connecting to the Digital iPEPS using the VNC viewer, a number of options are available.



Click here to access the options

There are four tabbed pages of options:

- Display
- Inputs
- Connection
- Expert

You can also reduce the four standard tabs to just one that contains only the most commonly used options by clicking the **Basic...** button in the lower left corner. The resulting page includes all of the Display items shown opposite plus the Connection options shown below:

## Connection

### View-only

When ticked, no control data (from keyboard or mouse) are sent to the Digital iPEPS.

### Pass special keys directly to server

When ticked, 'special' keys (the Windows key, the Print Screen key, Alt+Tab, Alt+Escape and Ctrl+Escape) are passed directly to the Digital iPEPS rather than being interpreted locally.

### Menu key

This feature allows you to select which function key is used to display the VNC viewer options menu. The menu key is the only way to exit from the full screen viewer mode.

Note: If you make any changes to the options given here and wish to retain them for successive connection sessions, ensure that the option 'Use these settings for all new connections' is ticked.

## Display

### Scaling

#### No Scaling

No attempt is made to make the screen image fit the viewer window. You may need to scroll horizontally and/or vertically to view all parts of the screen image.

#### Scale to Window Size

Adjusts the server screen image to suit the size of the viewer window.

#### Custom Size

Adjusts the server screen image according to the Width and Height settings in the adjacent fields. A drop box to the right of the fields allows you to define the image size by percentage or by pixels, as required.

#### Preserve Aspect Ratio

When ticked, maintains a consistent ratio between the horizontal and vertical dimensions of the screen image.

### Other options

#### Full screen mode

When ticked, opens the VNC Viewer in full screen mode.

#### Enable toolbar

When ticked, the VNC toolbar will be displayed whenever you hover your mouse near the top centre of the VNC window.

#### Adapt to network speed

When ticked, VNC will automatically adjust the image quality to suit the connection speed. When unticked, a slider allows you to choose the balance manually.

#### Always use best available colour quality (not in V5 viewers)

When ticked, the VNC Viewer will aim to maximise performance while still maintaining a full colour display (even on slower network connections) by affecting other aspects of operation. For instance, by reducing the amount of information sent about the mouse cursor position (which may make the mouse cursor movements appear jerky).

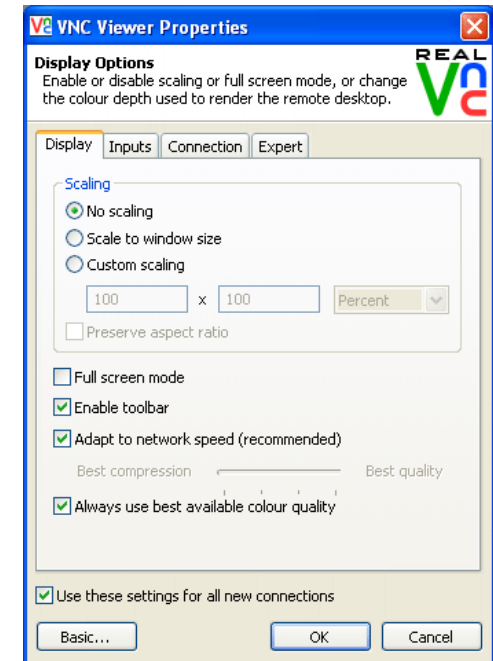

INSTALLATION

CONFIGURATION

OPERATION

FURTHER INFORMATION

INDEX

## Inputs

### Inputs:

When set to 'Enabled', all primary options below are ticked. The 'Disabled' setting unticks all of the primary options (causing 'view-only mode' where no control data may be sent to the Digital iPEPS. The 'Custom' setting is shown if you choose your own combination of options.

### Enable keyboard input

Allows keyboard data to be transferred to the Digital iPEPS.

### *Pass special keys directly to server*

When ticked, 'special' keys (the Windows key, the Print Screen key, Alt+Tab, Alt+Escape and Ctrl+Escape) are passed directly to the Digital iPEPS rather than being interpreted locally.

### Enable mouse input

Allows mouse data to be transferred to the Digital iPEPS.

### *Enable 3-button mouse emulation*

This feature allows you to use a 2-button mouse to emulate the middle button of a 3-button mouse. When enabled, press the left and right mouse buttons simultaneously to create a middle button action. You are advised to generally use a 3-button mouse.

### *Rate-limit mouse move events*

When ticked, this feature reduces the mouse movement information that is sent to the Digital iPEPS and host system. This is useful for slow connections and you will notice that the remote cursor will catch up with the local cursor roughly once every second.

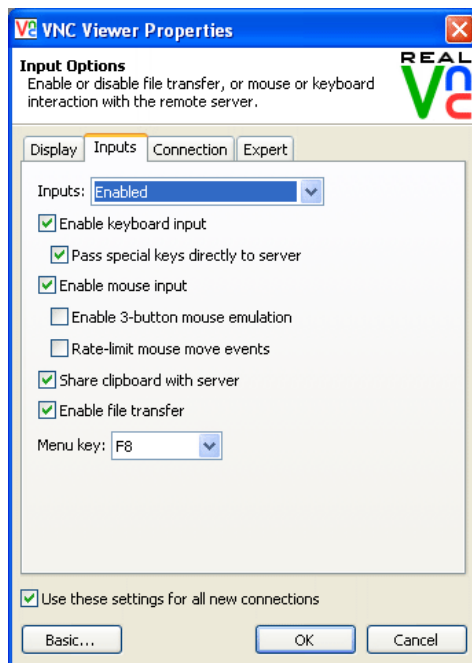

### Share clipboard with server

This permits the "Paste Clipboard" operation (see [Keyboard control](#)), and the "Create VM Drive" feature of Virtual Media (see [Virtual Media](#)).

### Enable file transfer

This permits the "file transfer" method of Virtual Media (see [Virtual Media](#)).

### Menu key

This feature allows you to select which function key is used to display the VNC viewer options menu. The menu key is the only way to exit from the full screen viewer mode.



INSTALLATION

CONFIGURATION

OPERATION

FURTHER  
INFORMATION

INDEX

## Connection

The options on this page are not relevant to Digital iPEPS connections and should be left in their default states.

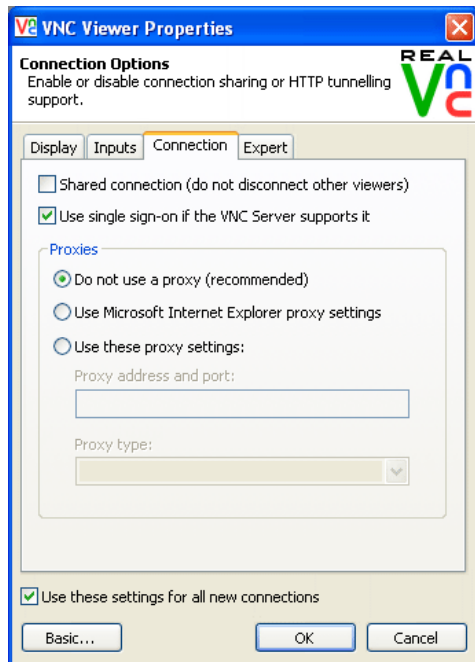

## Expert

The options within this section work correctly with Digital iPEPS in their default states and should not require alteration except in special circumstances.

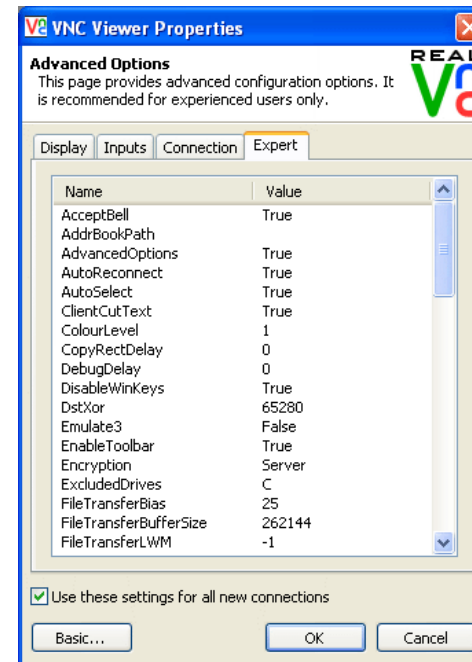

INSTALLATION

CONFIGURATION

OPERATION

FURTHER INFORMATION

INDEX

## Appendix 2 - VNC viewer window options

Click the VNC icon in the top left corner of the viewer window (or press F8) to display the window options:

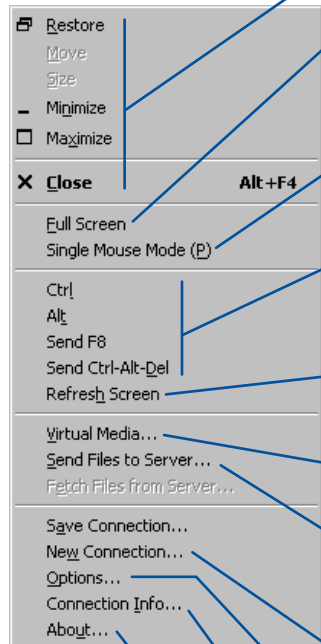

- **Standard window control items**
- **Full screen**  
Expands the VNC viewer window to fill the whole screen with no visible window edges or toolbar. Press F8 to re-display this menu.
- **Single mouse mode (P)**  
Used for fast network connections where a second, "predictor" cursor is not required.
- **Ctrl, Alt, Send F8, Send Ctrl-Alt-Del**  
Sends the selected keypress(es) to the Digital iPEPS and host computer. This is necessary because certain keys and key combinations are trapped by the VNC viewer.
- **Refresh Screen**  
Requests data from the server for a complete redraw of the screen image, not just the items that change.
- **Virtual Media...**  
Allows files to be transferred from the remote computer to the host. See [Virtual Media](#) for details.
- **Send Files to Server...**  
Allows files to be transferred from the remote computer to the host. See [Virtual Media](#) for details.
- **New connection...**  
Displays the connection dialogue so that you can log on to a different Digital iPEPS or VNC server location.
- **Options...**  
Displays the full range of connection options - see [Appendix 1](#) for more details.
- **Connection info...**  
Displays various connection and display details.
- **About...**  
Displays information about your VNC viewer.

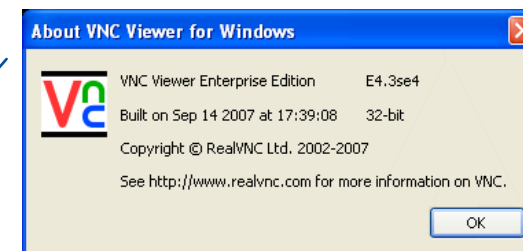
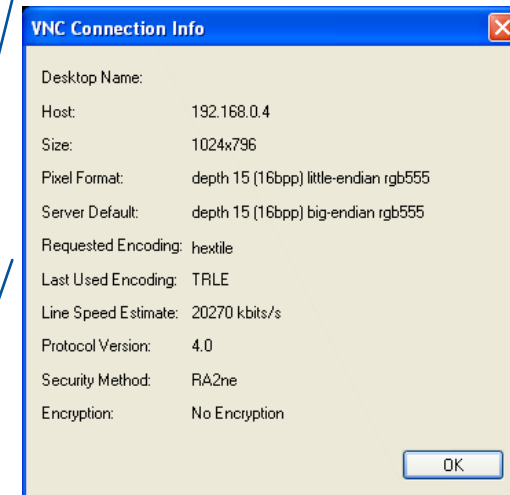
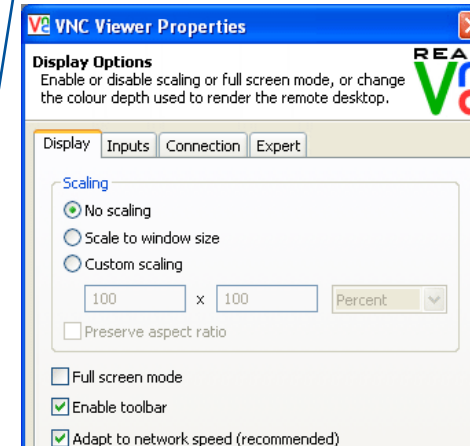
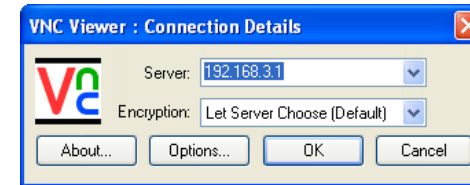

## Appendix 3 - Java viewer options

When you are connecting to the Digital iPEPS using the Java viewer, a number of options are available.

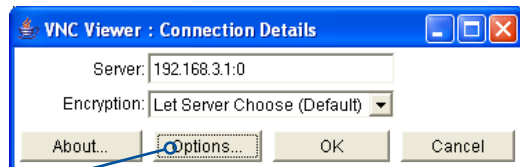

Click here to access the options

There are four options pages:

### Encoding and colour level

#### Auto select

When ticked, this option will examine the speed of your connection to the Digital iPEPS and apply the most suitable encoding method. This option is suggested for the majority of installations.

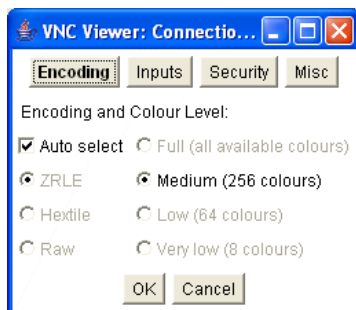

#### Preferred encoding

There are three manually selectable encoding methods which are accessible when the Auto select option is unticked.

- **ZRLE** – This is a highly compressed method that is best suited to slow modem connections.
- **Hextile** – This method offers better performance than the ZRLE when used over a high speed network because there is no need for the Digital iPEPS to spend time highly compressing the data.
- **Raw** – This is a primitive, uncompressed method that is mainly used for technical support issues. You are recommended not to use this method.

#### Colour level

The colour level is fixed at Medium (256 colours) for almost all browsers.

## Inputs

#### View only (ignore mouse & keyboard)

When ticked, the viewer will not send keyboard or mouse information to the Digital iPEPS or host computer.

#### Accept clipboard from server

This feature is restricted to software server versions of VNC and has no effect on Digital iPEPS installations.

#### Send clipboard to server

This feature is restricted to software server versions of VNC and has no effect on Digital iPEPS installations.

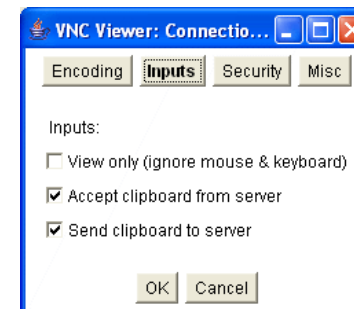

## Security

#### 512 bits (low security)

Selects the lowest level of encoding for communications between the browser and the Digital iPEPS.

#### 1024 bits (medium security)

Selects the middle level of encoding for communications between the browser and the Digital iPEPS.

#### 2048 bits (high security)

Selects the highest level of encoding for communications between the browser and the Digital iPEPS.

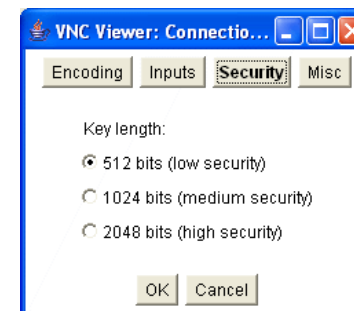

## Misc

#### Shared (don't disconnect other viewers)

This feature is restricted to software server versions of VNC and has no effect on Digital iPEPS installations.

#### Render cursor locally

This feature is restricted to software server versions of VNC and has no effect on Digital iPEPS installations.

#### Fast CopyRect

This option should remain enabled.

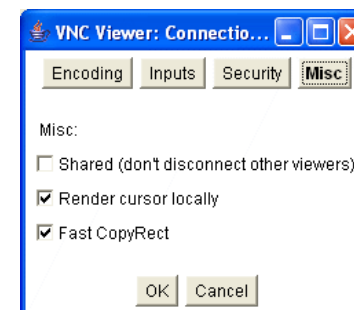

## Appendix 4 - Configuration menus

The unit has a main configuration menu through which you can access various sub menus to configure particular items.

### To view the main configuration menu

- 1 Using VNC viewer or a browser, log on as the 'admin' user.
- 2 Click the 'Configure' button in the top right corner. The main configuration menu will be displayed:

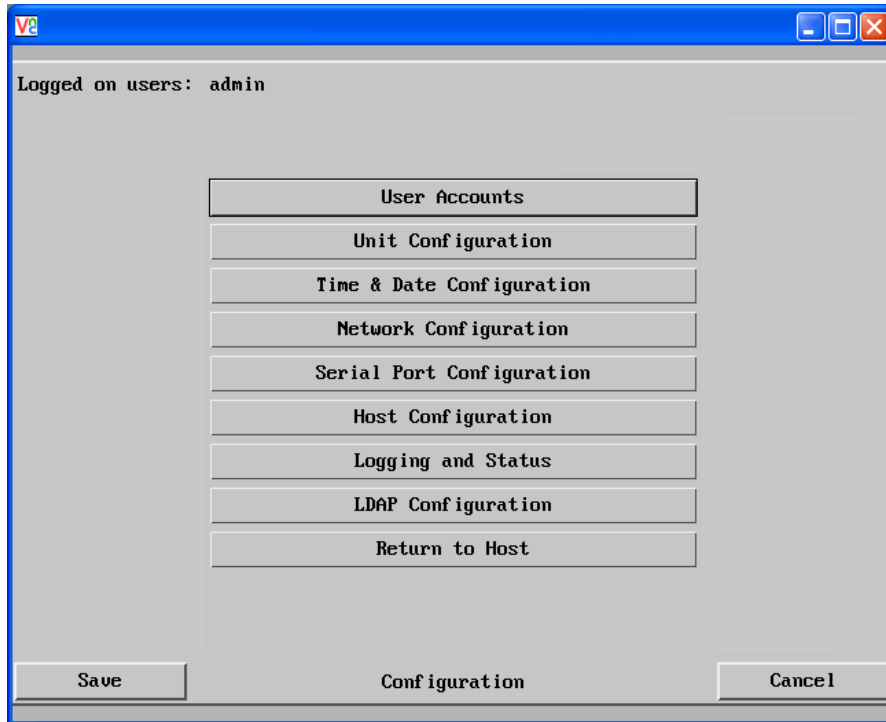

The various configuration pages are covered within this appendix:

- [User Accounts](#)
  - [Gui edit configuration](#)
- [Unit Configuration](#)
  - [EDID Configuration](#)
  - [Advanced Unit Configuration](#)
- [Time & Date Configuration](#)
- Network Configuration
  - [IPv4](#)
  - [IPv6](#)
- [Serial Port Configuration](#)
- [Host Configuration](#)
  - [Power switching configuration](#)
- [Logging and Status](#)
- [LDAP Configuration](#)

## User accounts

Up to 16 users can be created by the admin user, each with their password. The admin user can also determine whether the users are allowed access to the power control menu in order to turn servers on and off.

Logged on users: admin

User Name	Password	Local	Remote	Power	Menu B
admin	*****	<input checked="" type="checkbox"/>	<input checked="" type="checkbox"/>	<input checked="" type="checkbox"/>	Edit
		<input type="checkbox"/>	<input type="checkbox"/>	<input type="checkbox"/>	Edit
		<input type="checkbox"/>	<input type="checkbox"/>	<input type="checkbox"/>	Edit
		<input type="checkbox"/>	<input type="checkbox"/>	<input type="checkbox"/>	Edit
		<input type="checkbox"/>	<input type="checkbox"/>	<input type="checkbox"/>	Edit
		<input type="checkbox"/>	<input type="checkbox"/>	<input type="checkbox"/>	Edit
		<input type="checkbox"/>	<input type="checkbox"/>	<input type="checkbox"/>	Edit
		<input type="checkbox"/>	<input type="checkbox"/>	<input type="checkbox"/>	Edit
		<input type="checkbox"/>	<input type="checkbox"/>	<input type="checkbox"/>	Edit
		<input type="checkbox"/>	<input type="checkbox"/>	<input type="checkbox"/>	Edit
		<input type="checkbox"/>	<input type="checkbox"/>	<input type="checkbox"/>	Edit
		<input type="checkbox"/>	<input type="checkbox"/>	<input type="checkbox"/>	Edit
		<input type="checkbox"/>	<input type="checkbox"/>	<input type="checkbox"/>	Edit
		<input type="checkbox"/>	<input type="checkbox"/>	<input type="checkbox"/>	Edit
		<input type="checkbox"/>	<input type="checkbox"/>	<input type="checkbox"/>	Edit
		<input type="checkbox"/>	<input type="checkbox"/>	<input type="checkbox"/>	Edit

Save User Configuration Cancel

### To get here

- 1 Using VNC viewer or a browser, log on as the 'admin' user.
- 2 Click the 'Configure' button in the top right corner.
- 3 Click the 'User Accounts' option.

### User Name

All user names must consist of lower case characters or numbers only. No symbols or upper case characters are permissible. The user name can be between 1 and 32 characters in length but cannot contain foreign characters.

### Password

Each password can be between 1 and 16 characters in length. A suitable password is best constructed using a mixture of more than 6 letters, numbers and punctuation characters.

### Local

This column is greyed out as this feature is not available on Digital iPEPS.

### Remote

When ticked, the selected user can gain access via an IP network link (such as a local intranet or the wider Internet, depending on how the Digital iPEPS is connected) and/or Console Server access.

### Power

When ticked, the selected user will be permitted to control the power input to host systems (requires optional power control switch unit(s) to be fitted).

### Menu Bar

Optionally click to customise the menu bar for each user. See next page.



## Gui edit configuration

If required, you can customise the menu bar of the viewer window to ensure that it contains only the necessary options.

The menu bar can be edited locally by each user or edited singly by the admin or alternatively, the admin can globally alter the menu bar for all users.

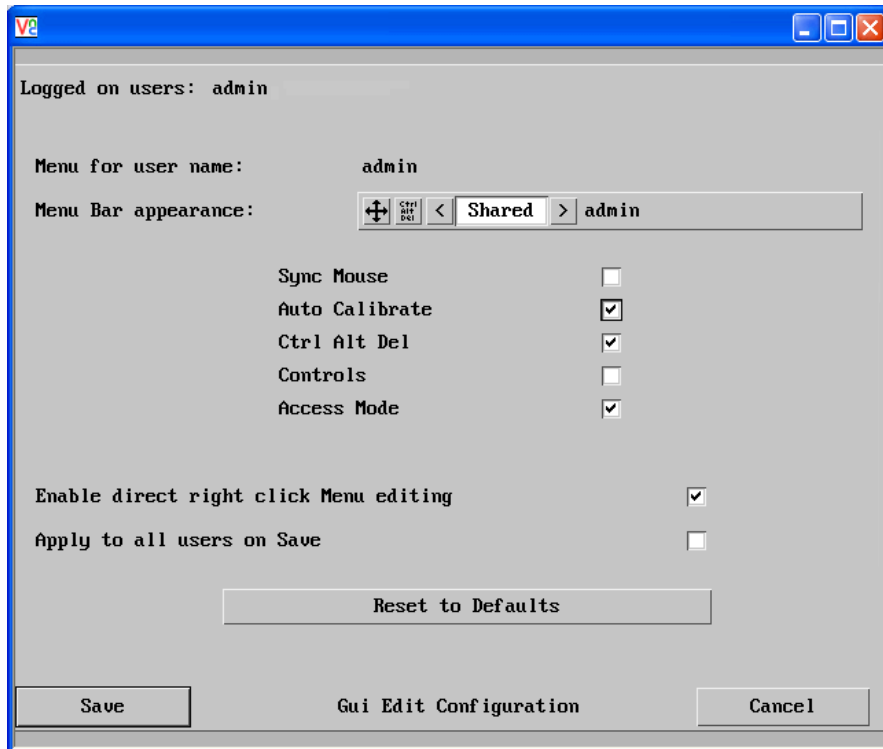

### To globally edit the menu bar via admin

- 1 Using VNC viewer or a browser, log on as the 'admin' user.
- 2 Click the 'Configure' button in the top right corner.
- 3 Click on User Configuration
- 4 Click on the relevant Edit button.

### To edit the menu bar locally

- 1 Login remotely via VNC viewer and display the viewer window.
- 2 Place the mouse pointer on the menu bar and click the right mouse button. A popup will be displayed:

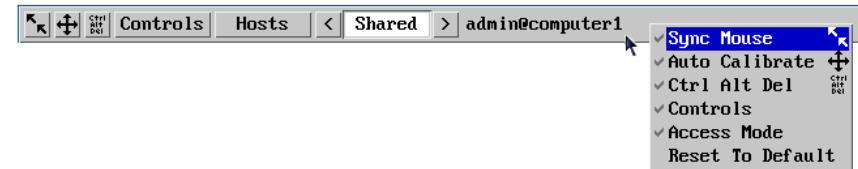

- 3 Click on any option within the popup to add it to or remove it from the menu bar.
- 4 When all changes have been made, click anywhere else within the viewer window.

Changes made in this way will affect the individual user only.

## Unit configuration

This page provides access to a selection of both basic and advanced settings for the Digital iPEPS. Many of the settings displayed here are also accessible through the on-screen menu.

The screenshot shows a window titled 'Unit Configuration' with the following settings:

- Logged on users: admin
- Hardware Version: IPEPS\_DVI 16M+16M
- Firmware Version: 3.3.4
- Host Keyboard Layout: UK
- Admin Password: [Redacted]
- Unit Name: Bottom Box
- New Connections Private:
- Menu Bar Toggle Hot Key: None
- Display Menu Bar for New Connections:
- Encryption: Always On
- Number of simultaneous UNC Users: 4
- UNC Viewer Hot Key Sequence: Ctrl+Alt

Buttons at the bottom: Save, Unit Configuration, Cancel. Additional buttons: EDID Configuration, Advanced Unit Configuration.

### Hardware Version

Indicates the version of the electronic circuitry within the Digital iPEPS unit.

### Firmware Version

Indicates the version of the internal software within the Digital iPEPS flash memory. This may be updated using the [flash upgrade procedure](#).

### Host Keyboard Layout

Use the arrow buttons to match the keyboard layout expected by the host system.

### Admin (Change) Password

Click this button to enter/edit the password that will be used to gain administrator access to the Digital iPEPS.

### To get here

- 1 Using VNC viewer or a browser, log on as the 'admin' user.
- 2 Click the 'Configure' button in the top right corner.
- 3 Click the 'Unit Configuration' option.

### Unit Name

The name entered here will be displayed on the local menus and the remote VNC viewer/browser windows.

### New Connections Private

Allows you to determine whether new local or VNC connections should be set up as private (when ticked) or as shared (when unticked).

### Menu Bar Toggle Hot Key

Determines the function key that can be used to display/hide the menu bar within the VNC screen.

### Encryption

Three options are available: Always on, prefer off, prefer on. The one to choose depends on the specific details of your installation. The use of encryption imposes a slight performance overhead of roughly 10% but is highly secure against third party intrusion.

### Number of simultaneous VNC Users

Allows you to restrict the number of concurrent VNC sessions. The maximum number (and the default setting) is 4.

### VNC Viewer Hot Key Sequence

When using the VNC Viewer, you can use key press combinations to select host computers and also to display the host selection menu. This option allows you to choose which keys should be used to form the hotkeys that will precede a switching command. The default setting is CTRL + ALT, so as an example when you press the CTRL ALT and 2 keys, the viewer will change to the host with "Hotkey Host Number" 2 - see [Host configuration](#).

### [EDID Configuration](#)

### [Advanced Unit Configuration](#)

## EDID configuration

Click this button to display advanced EDID options that do not normally require alteration.



Logged on users: admin

**Preferred Timing**

Preferred Mode 1280 x 1024 @ 60Hz 108.00 MHz

active	fp sync	bp	polarity	active	fp sync	bp	polarity				
Horizontal	1280	48	112	248	Pos	Vertical	1024	1	3	38	Pos

**Established Timing**

720 x 400 @ 70 Hz	<input checked="" type="checkbox"/>	640 x 480 @ 60 Hz	<input checked="" type="checkbox"/>	640 x 480 @ 67 Hz	<input checked="" type="checkbox"/>	640 x 480 @ 72 Hz	<input checked="" type="checkbox"/>
640 x 480 @ 75 Hz	<input checked="" type="checkbox"/>	800 x 600 @ 56 Hz	<input checked="" type="checkbox"/>	800 x 600 @ 60 Hz	<input checked="" type="checkbox"/>	800 x 600 @ 72 Hz	<input checked="" type="checkbox"/>
800 x 600 @ 75 Hz	<input checked="" type="checkbox"/>	832 x 624 @ 75 Hz	<input checked="" type="checkbox"/>	1024 x 768 @ 60 Hz	<input checked="" type="checkbox"/>	1024 x 768 @ 70 Hz	<input checked="" type="checkbox"/>
1024 x 768 @ 75 Hz	<input checked="" type="checkbox"/>	1280 x 1024 @ 75 Hz	<input checked="" type="checkbox"/>	1152 x 870 @ 75 Hz	<input checked="" type="checkbox"/>		

**Standard Timing**

1920 x 1080 @ 60Hz	1920 x 1200 @ 60Hz	800 x 600 @ 85Hz	1024 x 768 @ 85Hz
1152 x 864 @ 75Hz	1280 x 960 @ 60Hz	1280 x 1024 @ 85Hz	1600 x 1200 @ 60Hz
1152 x 864 @ 60Hz	1280 x 1024 @ 67Hz	640 x 480 @ 85Hz	

Support Default GTF

**Coordinated Video Timing (CUT)**

1920 x 1200 @ 60Hz RB

This page allows you to edit the contents of the EDID records that are used to inform the computer of the supported video modes. The default EDID should be sufficient for the vast majority of situations. If necessary, use the Edit Preferred and Standard Timing button fine tune settings to support specific situations.

When you click the Save button, the EDID information within the unit will be updated. As the EDID is usually only read when a computer is booted, it may be necessary to power cycle the host computer to make it re-read the new EDID.

Logged on users: admin

**Preferred Timing Mode**

Resolution: 1280 X 1024 @ 60 Hz

Pixel Clock: 108.00

Active Front Sync Back Polarity  
Porch Porch

Horizontal 1280 48 112 248 < + >

Vertical 1024 1 3 38 < + >

**Standard Timing Modes**
**Coordinated Video Timing Modes**

X  @  Hz

- 1920 x 1080 @ 60Hz
- 1920 x 1200 @ 60Hz
- 800 x 600 @ 85Hz
- 1024 x 768 @ 85Hz
- 1152 x 864 @ 75Hz

X  @  Hz RB

- 1920 x 1200 @ 60Hz RB
- 1440 x 900 @ 60Hz

INSTALLATION

CONFIGURATION

OPERATION

FURTHER INFORMATION

INDEX

## Advanced unit configuration

Click this button to display advanced options that do not normally require alteration.

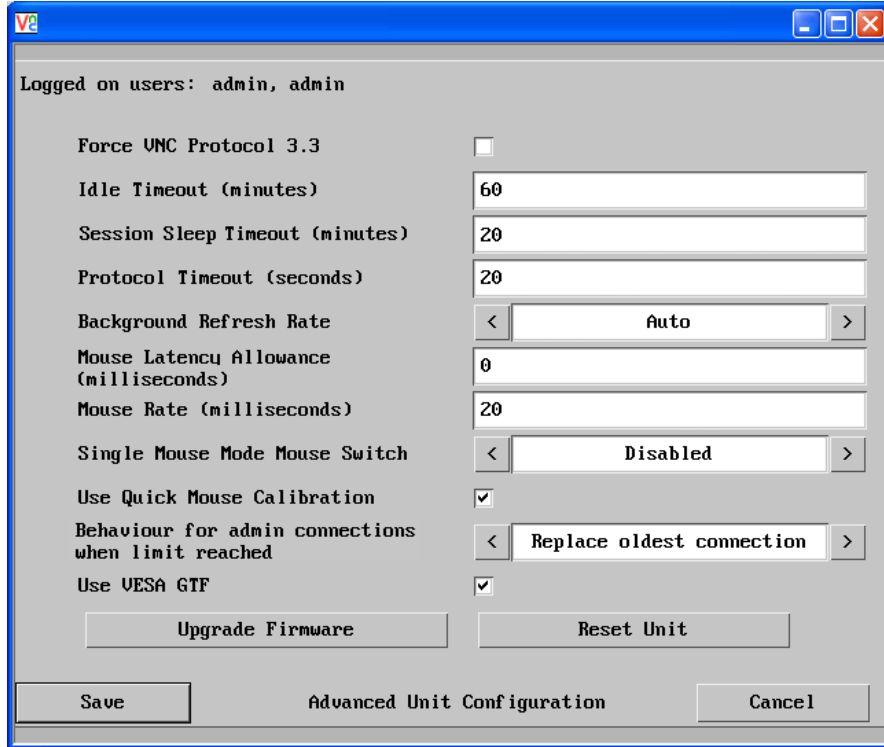

Logged on users: admin, admin

Force VNC Protocol 3.3

Idle Timeout (minutes) 60

Session Sleep Timeout (minutes) 20

Protocol Timeout (seconds) 20

Background Refresh Rate < Auto >

Mouse Latency Allowance (milliseconds) 0

Mouse Rate (milliseconds) 20

Single Mouse Mode Mouse Switch < Disabled >

Use Quick Mouse Calibration

Behaviour for admin connections when limit reached < Replace oldest connection >

Use VESA GTF

Upgrade Firmware Reset Unit

Save Advanced Unit Configuration Cancel

### Force VNC Protocol 3.3

**IMPORTANT:** The use of this option is not recommended. Protocol 3.3 is a legacy version that does not offer any encryption.

### Idle Timeout

Determines the period of inactivity on a global connection before the user is logged out. The idle timeout period can be set to any time span, expressed in minutes.

### Session Sleep Timeout

Determines the period of inactivity before the viewer screen will blank and a message is displayed. When no hosts are being viewed either because of this time out or if no viewers are active then parts of the video circuitry are powered down reducing power consumption by up to a third.

### Protocol Timeout

Sets the time period by which responses should have been received to outgoing data packets. If the stated period is exceeded, then a connection is considered lost and terminated.

### Background Refresh Rate

Use the arrow keys to alter the background refresh rate used to correct any screen changes missed in normal operation. The options are: Slow, Medium, Fast, Auto or Disabled. The Auto option automatically varies the refresh rate when multiple VNC sessions are active to provide a balance between the sessions.

*Note: When a low connection speed is detected, the background refresh is automatically disabled, regardless of the settings of this option.*

### Mouse Latency Allowance

This option is used during calibration to account for latency delays that may be caused as signals pass through a device.

During calibration, the Digital iPEPS waits for 40ms after each mouse movement before sampling the next. If a device adds a significant delay to the flow of data, the calibration process can be lengthened or may fail entirely. The value entered here is added to (or subtracted from) the default 40ms sampling time.

*Note: You can enter negative values (down to -40) in order to speed up the calibration process when using fast KVM switches. Use this option with caution as it can adversely affect the calibration process.*

### Mouse Rate

Defines the rate at which mouse movement data are transmitted to the system. The default option is 20ms, which equates to 50 mouse events per second. This is used to slow down the rate in exceptional circumstances but normally requires no adjustment.

### Single Mouse Mode Mouse Switch

Select the mouse button combination to exit from single mouse mode (when active).

### Use Quick Mouse Calibration

Invokes optimised calibration techniques that handle the majority of mouse types.

### Behaviour for admin connections when limit reached

Determines what should occur when four global connections already exist and a fifth, administrator connection attempt is made. Options are: *Replace oldest connection*, *Replace newest connection* and *Don't replace*. Only non-administrator connections can be terminated in this way.

### Use VESA GTF

When ticked, the VESA Generalized Timing Formula will be used to help determine the correct input video resolution and timing details.

### Upgrade firmware

Places the unit into upgrade mode. See [Upgrading Digital iPEPS](#).

### Reset Unit

Performs a complete cold boot of the Digital iPEPS unit.

## Time & date configuration

This page allows you to configure all aspects relating to time and date within the unit.

Note: The unit has a real-time clock which will maintain the date and time for a few hours without power.

Time & Date Configuration dialog box showing fields for Time And Date, Timezone specifier (e.g. EST5), Use NTP, and NTP Server IP address. The 'Set Time from NTP Server' button is visible.

### Time and Date

Use the arrow buttons to set the correct current time.

### Use NTP

When this option is selected, the Digital iPEPS will synchronise its internal clocks using information from the (Network Time Protocol) server listed in the *NTP Server IP address* field.

### NTP Server IP address

Optionally enter the IP address for a known Network Time Protocol server.

### To get here

- 1 Using VNC viewer or a browser, log on as the 'admin' user.
- 2 Click the 'Configure' button in the top right corner.
- 3 Click the 'Time & Date Configuration' option.

### Set Time from NTP Server

Click to immediately use the time and date information from the listed NTP server.

### Timezone specifier

Optionally enter a recognised timezone specifier related to the current position of the Digital iPEPS unit. When an NTP server is used, the specifier will be used to provide the correct real time.

The timezone specifier takes the following form:

*std offset dst [offset], start[/time], end[/time]*

The *std* and *offset* specify the standard time zone, such as GMT and 0, or CET and -1, or EST and 5, respectively.

The *dst* string and [*offset*] specify the name and offset for the corresponding Daylight Saving Time zone; if the *offset* is omitted, it defaults to one hour ahead of standard time.

The remainder of the specification describes when Daylight Saving Time is in effect. The *start* field is when Daylight Saving Time goes into effect and the *end* field is when the change is made back to standard time. The most common format used for the daylight saving time is: *mm.w.d*

Where: *m* specifies the month and must be between **1** and **12**. The day *d* must be between **0** (Sunday) and **6**. The week *w* must be between **1** and **5**; week **1** is the first week in which day *d* occurs, and week **5** specifies the *last d* day in the month.

The *time* fields specify when, in the local time currently in effect, the change to the other time occurs. If omitted, the default is **02:00:00**.

Typical examples are:

UK:	GMT0BST,M3.5.0/1,M10.5.0/2
Central Europe:	CET-1CEST,M3.5.0/2,M10.5.0/3
US Eastern:	EST5EDT,M3.2.0/2,M11.1.0/2
US Pacific:	PST5PDT,M3.2.0/2,M11.1.0/2

### For further details

- For details of timezone specifier formats, please refer to: [http://www.gnu.org/software/libc/manual/html\\_node/TZ-Variable.html](http://www.gnu.org/software/libc/manual/html_node/TZ-Variable.html)
- For details of the Network Time Protocol (main RFC number: 1305; the SNTP subset used as the basis for the Digital iPEPS: 4330) <http://www.ietf.org/rfc.html>



## Network configuration (IPV4)

This page allows you to configure the various aspects of the IP port when it is used in IPV4 mode. For [IPV6](#) mode, please see the next page.

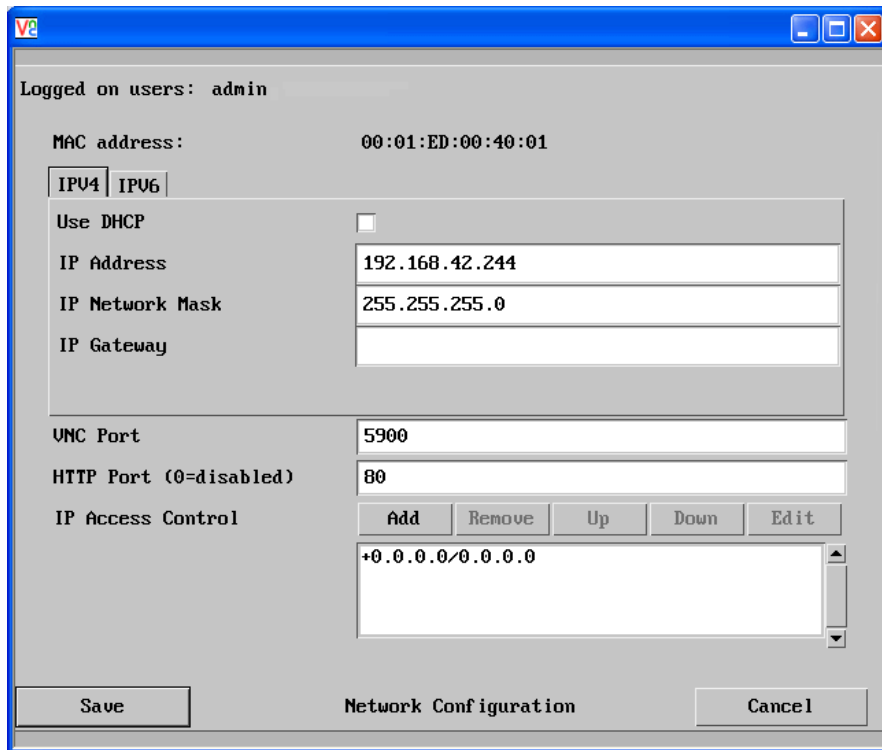

The screenshot shows a 'Network Configuration' window with the following fields and controls:

- Logged on users: admin
- MAC address: 00:01:ED:00:40:01
- IPV4 | IPV6 (selected)
- Use DHCP:
- IP Address: 192.168.42.244
- IP Network Mask: 255.255.255.0
- IP Gateway: (empty)
- VNC Port: 5900
- HTTP Port (0=disabled): 80
- IP Access Control: Add, Remove, Up, Down, Edit buttons and a list containing '+0.0.0.0/0.0.0.0'
- Buttons: Save, Cancel

### MAC address

Media Access Control address – this is the unique and unchangeable code that was hard coded within your Digital iPEPS unit when it was built. It consists of six 2-digit hexadecimal (base 16) numbers separated by colons. A section of the MAC address identifies the manufacturer, while the remainder is effectively the unique electronic serial number of your particular unit.

### Use DHCP

DHCP is an acronym for 'Dynamic Host Configuration Protocol'. Its function is particularly useful when connecting to medium size or larger networks. When this option is selected, your Digital iPEPS will attempt to locate a DHCP server on the network. If such a server is located, it will supply three things to the Digital iPEPS: an IP address, an IP network mask (also known as a Subnet mask) and a Gateway address. These are not usually granted permanently, but on a 'lease' basis for a fixed amount of time or for as long as the Digital iPEPS remains connected and switched on. [Discover allocations](#).

### To get here

- 1 Using VNC viewer or a browser, log on as the 'admin' user.
- 2 Click the 'Configure' button in the top right corner.
- 3 Click the 'Network Configuration' option.

### IP Address

This is the identity of the Digital iPEPS within a network. The IP address can be thought of as the telephone number of the Digital iPEPS. Unlike the MAC address, the IP address can be altered to suit the network to which it is connected. It can either be entered manually or configured automatically using the DHCP option. When the DHCP option is enabled, this entry is greyed out.

### IP Network Mask

Also often called the subnet-mask, this value is used alongside the IP address to help define a smaller collection (or subnet) of devices on a network. In this way a distinction is made between locally connected devices and ones that are reachable elsewhere, such as on the wider Internet. This process helps to reduce overall traffic on the network and hence speed up connections in general.

### IP Gateway

This is the address of the device that links the local network (to which the Digital iPEPS is connected) to another network such as the wider Internet. Usually the actual gateway is a network router and it will be used whenever a required address lies outside the current network.

### VNC Port

This is the logical link through which communications with a remote VNC viewer will be channelled. The default setting is 5900 which is a widely recognised port number for use by VNC software. However, in certain circumstances it may be advantageous to alter this number - see 'Security issues with ports' for more details.

### HTTP Port

This is the logical link through which communications with a remote web browser will be channelled. The default setting of 80 is an established standard for web (HTTP – HyperText Transfer Protocol) traffic though this can be changed to suit your local network requirements.

### IP Access Control

This section allows you to optionally specify ranges of addresses which will or won't be granted access to the Digital iPEPS. If this option is left unchanged, then the default entry of '+0.0.0.0/0.0.0.0' ensures that access from all IP addresses will be permitted. See [Setting IP access control](#) for details.



## Network configuration (IPv6)

This page allows you to configure the various aspects of the IP port when it is used in [IPv6](#) mode. For IPv4 mode, please see the previous page.

The screenshot shows the 'Network Configuration' dialog box. At the top, it says 'Logged on users: admin'. Below that is the 'MAC address' field with the value '00:01:ED:00:40:01'. There are two tabs: 'IPV4' and 'IPV6', with 'IPV6' selected. Under the 'IPV6' tab, there is a section for 'Enable IPv6' with a checked checkbox, and 'Use DHCPv6' with an unchecked checkbox. Below this is the 'IPv6 Addresses' section with a list box containing 'fe80::201:edff:fe00:4001/64' and buttons for 'Add', 'Remove', and 'Edit'. The 'IP Gateway' field is empty. The 'VNC Port' is set to '5900' and the 'HTTP Port (0=disabled)' is set to '80'. The 'IP Access Control' section has a list box with '+0.0.0.0/0.0.0.0' and buttons for 'Add', 'Remove', 'Up', 'Down', and 'Edit'. At the bottom, there are 'Save' and 'Cancel' buttons.

### MAC address

Media Access Control address – this is the unique and unchangeable code that was hard coded within your Digital iPEPS unit when it was built. It consists of six 2-digit hexadecimal (base 16) numbers separated by colons. A section of the MAC address identifies the manufacturer, while the remainder is effectively the unique electronic serial number of your particular unit.

### Enable IPv6

Change this option to Yes only if the Digital iPEPS unit is connected to an IPv6 compliant network.

### IPv6 Addresses

This section is used to hold the IPv6 addresses for the Digital iPEPS. A link local IPv6 address is automatically added using the [Stateless Address Auto Configuration](#) protocol. Use the Add, Remove, Edit buttons to alter the address as necessary.

### To get here

- 1 Using VNC viewer or a browser, log on as the 'admin' user.
- 2 Click the 'Configure' button in the top right corner.
- 3 Click the 'Network Configuration' option.
- 4 Click the 'IPv6' tab.

### Use DHCPv6

When this option is set to Yes, the Digital iPEPS will attempt to locate a DHCPv6 server on the network to derive a unique IPv6 address for itself as well as an address for the IPv6 Gateway. These are not usually granted permanently, but on a 'lease' basis for a fixed amount of time or for as long as the Digital iPEPS remains connected and switched on. [Discover allocations](#).

If this option is set to No, the Digital iPEPS will use the [Stateless Address Auto Configuration](#) protocol to determine its own IPv6 address. This will be shown in the IPv6 Addresses field and can be edited if necessary.

### IP Gateway

This is the address of the device that links the local network (to which the Digital iPEPS is connected) to another network such as the wider Internet. Usually the actual gateway is a network router and it will be used whenever a required address lies outside the current network.

### VNC Port

This is the logical link through which communications with a remote VNC viewer will be channelled. The default setting is 5900 which is a widely recognised port number for use by VNC software. However, in certain circumstances it may be advantageous to alter this number - see 'Security issues with ports' for more details.

### HTTP Port

This is the logical link through which communications with a remote web browser will be channelled. The default setting of 80 is an established standard for web (HTTP – HyperText Transfer Protocol) traffic though this can be changed to suit your local network requirements.

### IP Access Control

This section allows you to optionally specify ranges of addresses which will or won't be granted access to the Digital iPEPS. If this option is left unchanged, then the default entry of '+0.0.0.0/0.0.0.0' ensures that access from all IP addresses will be permitted. See [Setting IP access control](#) for details.



## Setting IP access control

The golden rule with this feature is 'Include before you exclude' or to put it another way 'Arrange *allowed* addresses in the list *before* the *denied* addresses'.

This is because the positions of entries in the list are vitally important. Once a range of addresses is denied access, it is not possible to make exceptions for particular addresses within that range. For instance, if the range of addresses from A to F are denied access first, then the address C could not be granted access lower down the list. Address C needs to be placed in the list before the denied range.

*IMPORTANT: This feature should be configured with extreme caution as it is possible to deny access to everyone. If such an error occurs, you will need to perform a [reset to factory default settings](#) in order to regain access.*

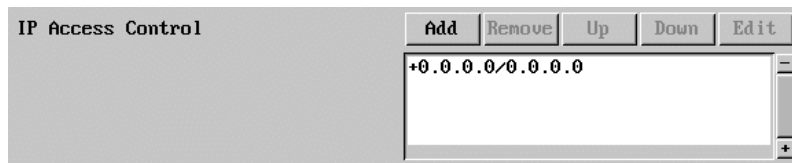

In the list, access control addresses prefixed by '+' are allow entries while those prefixed by '-' are deny entries.

### To get here

- 1 Using VNC viewer or a browser, log on as the 'admin' user.
- 2 Click the 'Configure' button in the top right corner.
- 3 Click the 'Network Configuration' option.

## To define a new IP access control entry

- 1 Click the Add button to display a popup dialogue:

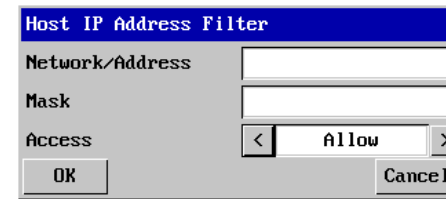

### Network/Address

Enter the network address that is to be allowed or denied access. If a range of addresses is being specified then specify any one of the addresses within the range and use the Mask entry to indicate the size of the range.

### Mask

Enter an IP network mask that indicates the range of addresses that are to be allowed or denied access. For instance, if only a single specified IP address were to be required, the mask entry would be 255.255.255.255 in order to specify a single location.

### Access

Use the arrow buttons to select either 'Allow' or 'Deny' as appropriate.

- 2 Enter the base network address, the mask and select the appropriate access setting.
- 3 Click the OK button.

## To reorder access control entries

*IMPORTANT: When reordering, ensure that any specific allowed addresses are listed higher in the list than any denied addresses. Take care not to invoke any deny access settings that would exclude valid users.*

- 1 In the access control list, click on the entry to be moved.
- 2 Click the Up or Down buttons as appropriate.

## To edit/remove access control entries

- 1 In the access control list, click on the appropriate entry.
- 2 Click either the Edit or Remove button as appropriate.



## Serial port configuration

This page allows you to configure the baud rate of the Digital iPEPS serial port that is used to control power switch devices. A full range of standard baud rates are available.

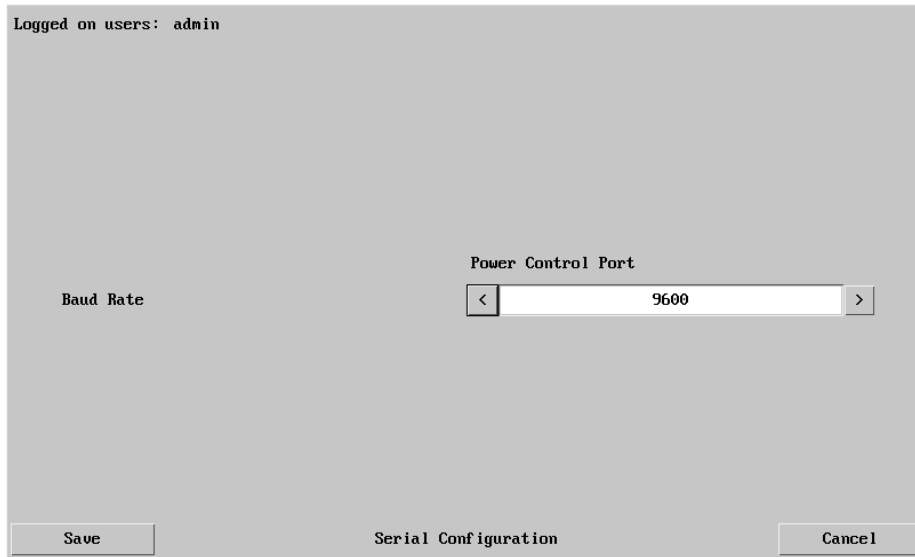

Logged on users: admin

Power Control Port

Baud Rate

Save Serial Configuration Cancel

### To get here

- 1 Using VNC viewer or a browser, log on as the 'admin' user.
- 2 Click the 'Configure' button in the top right corner.
- 3 Click the 'Serial port Configuration' option.

### Baud Rate

Determines the communication speed of the OPTIONS port when the above setting is configured to 'Power Control'. The other communication settings are fixed as: No parity, 8 bit word, 1 stop bit.



INSTALLATION

CONFIGURATION

OPERATION

FURTHER  
INFORMATION

INDEX

## Host configuration

This page provides the opportunity to configure various details for each of the host systems that may be connected to the Digital iPEPS. Each entry can be configured with a name, the permitted users, the hot key combinations required to switch to it and, if required, appropriate power control commands.

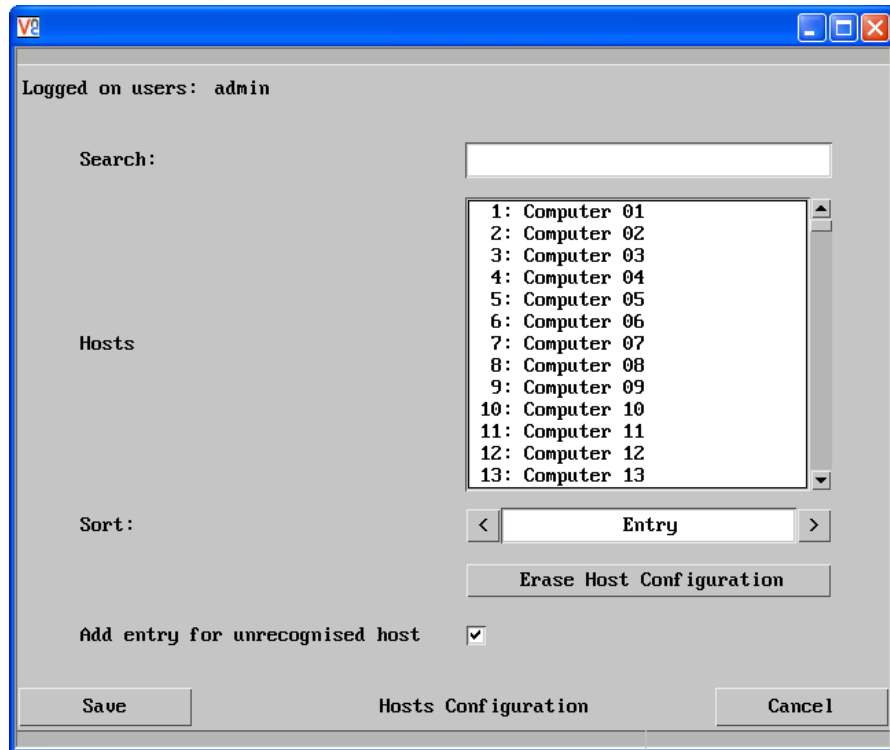

### Add entry for unrecognised host

When selected, any systems visited that are not specified in the Hosts list, will be added to the list.

### Sort

Allows you to reorder the list of hosts either alphabetically or by entry number.

### Erase Host Configuration

Removes all hosts from the list.

### To get here

- 1 Using VNC viewer or a browser, log on as the 'admin' user.
- 2 Click the 'Configure' button in the top right corner.
- 3 Click the 'Host Configuration' option.

## To create a new host entry

- 1 Click one of the host entries to reveal a Host configuration dialogue.

### Name

Enter the name that will be displayed in the viewer window when you click the Host button.

### Users

Select the users that will be permitted to connect to this host. Either enter \* to allow all users or a list of users separated by commas.

### KVM Switch Macro

Declare the hot key sequence, or Adder Port Direct address that will cause the KVM switch to link with the required host system. Adder Port Direct addresses must be entered within square brackets. See [Appendix 10 - Hotkey sequences and Adder Port Direct](#) for details.

### Hotkey Host Number

Declare the numeric sequence that is pressed together with the VNC viewer hotkeys (usually Ctrl + Alt) to select this host system, which is the same value as the KVM port number.

### Power On

Enter the code required to make an attached power control unit apply power to the host. See [Power switching configuration](#) for details.

### Power Off

Enter the code required to make an attached power control unit remove power from the selected host.

### Reboot

Enter the code required to make an attached power control unit remove power and then re-apply it a few seconds later.

- 2 Enter the required information in each field.
- 3 Click the OK button.

## Power switching configuration

Power switch configuration comprises two main steps:

- Configure the **OPTIONS** serial port to the same speed as used by the power switch box(es), using the [Serial port configuration menu](#).
- Configure power ON and OFF strings for each relevant host computer.

For each power port there needs to be a valid 'Power ON string' and similarly an appropriate 'Power OFF string'. In each case, the strings are a short sequence of characters that combine a port address and a power on or off value.

If a particular computer has more than one power input (and thus requires an equivalent number of power ports to control them), collections of strings can be combined to switch all of the required ports together as a group.

### To configure the power sequences for each host computer

- 1 Using VNC viewer or a browser, log on as the 'admin' user.
- 2 Click the 'Configure' button in the top right corner.
- 3 Click the 'Host configuration' option.
- 4 Click a host entry to display a Host configuration dialogue:
- 5 If necessary, configure other parameters (Name, Users, Hot Keys - [MORE](#)).

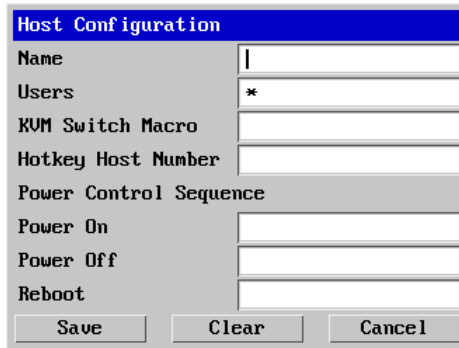

- 6 Enter the **Power control sequences** in the Power On, Power Off and Reboot fields ⇨
- 7 Click OK to close the dialogue and then click the Save button in the main Host Configuration window to store the details.

## Power control sequences

*Notes: The settings given below are for Adder power switches model numbers PSU-8SLAVE and PSU-1GUARD - other power switches may require different settings. Please refer to your power switch documentation for details about codes required by other power switches.*

The structure of each power sequence (OFF, ON or Reboot) is as follows:

`/Pxy=z\0D`

Where:

- x** is the switch box number,
- y** is the power port number,
- z** is '0' for OFF or '1' for ON
- r** is for Reboot, and
- \0D** represents Enter (or Carriage return).

### Example 1

To switch ON port 5 of switch box 2, the code would be as follows:

- Power sequence: P25=1\0D

### Example 2

To switch OFF port 8 of switch box 3, the code would be as follows:

- Power sequence: P38=0\0D

For details about operating this feature, see [Power switching control](#) within the Operation chapter.

### To control two or more ports simultaneously

You can control up to four power ports using a single sequence. This is done using the same command structure as shown above, plus a delay command, for each port. Immediately following a port command, insert the characters '\\*' before the next port command, and so on up to four ports. For instance, to switch on ports 1 and 2 in the first power switch, the command line would be:

P11=1\0D\\*P12=1\0D

## Logging and status

This screen provides various details about the user activity on the Digital iPEPS unit.

**Date and time the event occurred**

**Type of event, user name and access method or remote IP address**

Logged on users: admin

```
Jan 1 23:23:49 arkapp: Logoff admin, local
Jan 1 23:23:50 arkapp: Logon admin, local, autologon
Jan 1 23:23:57 arkapp: Logoff admin, local
Jan 1 23:23:58 arkapp: Logon admin, local, autologon
Jan 1 23:24:32 arkapp: Logoff admin, local
Jan 1 23:24:40 arkapp: Logon steve, local, password
Jan 1 23:27:48 arkapp: Switch to host Computer 01
Jan 1 23:36:50 arkapp: disconnected: 192.168.0.2::2131 (Idle timeout )
Jan 1 23:36:50 arkapp: Logoff admin, 192.168.0.2
Jan 1 23:37:37 arkapp: Logoff steve, local
Jan 1 23:37:43 arkapp: Logon admin, local, no auth
Jan 2 00:21:39 arkapp: connected: 192.168.0.2::2286
Jan 2 00:21:43 arkapp: Logon admin, 192.168.0.2, no auth
Jan 2 00:21:43 arkapp: authenticated: 192.168.0.2::2286, as admin (Default access)
```

Clear Log Refresh

Syslog Server IP Address

Save Logging and Status Cancel

Click to clear all log entries

Click to refresh the list

Optionally enter an IP address to which the status log should be sent

Click to return to the main menu

### To copy and paste the log

You can copy the information listed within the log and paste it into another application.

- 1 While viewing the log screen, press Ctrl and C, to copy the data into the clipboard.
- 2 In a text application (i.e. Word, WordPad, Notepad) press Ctrl and V, or right mouse click and 'Paste'.

### Syslog Server IP Address

Logging information can optionally be sent, as it occurs, to a separate system using the standard Syslog protocol. Enter the IP address of a suitable system in the field provided.

### For further details

- For details of the Syslog protocol (RFC number: 3164) <http://www.ietf.org/rfc.html>

### To get here

- 1 Using VNC viewer or a browser, log on as the 'admin' user.
- 2 Click the 'Configure' button in the top right corner.
- 3 Click the 'Logging and Status' option.

## LDAP configuration

The Digital iPEPS can optionally use the industry standard LDAP (Lightweight Directory Access Protocol) to allow user authentication to occur in conjunction with an externally held database. This screen allows you to configure details related to the creation of an LDAP link to an external directory service, such as an Active Directory server.

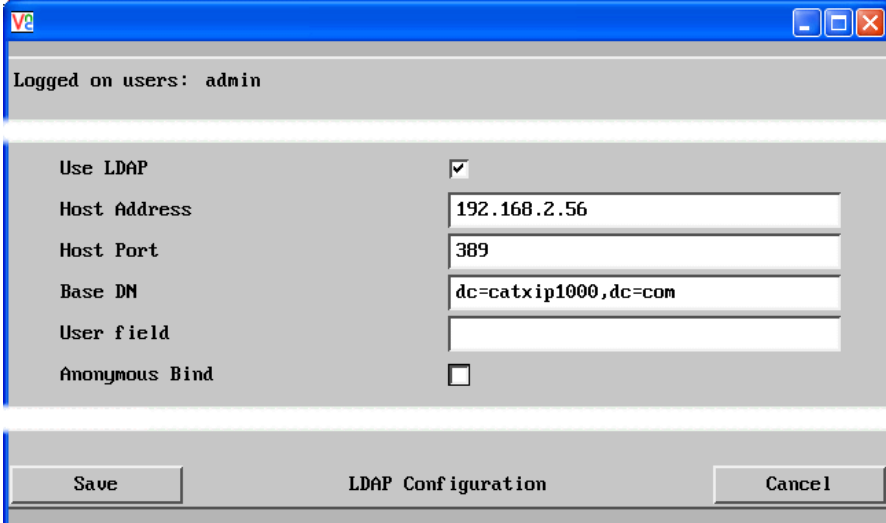

Logged on users: admin

Use LDAP

Host Address 192.168.2.56

Host Port 389

Base DN dc=catxip1000,dc=com

User field

Anonymous Bind

Save LDAP Configuration Cancel

### Use LDAP

Tick this option to enable the Lightweight Directory Access Protocol features of the unit.

### Host Address

Enter the IP address of the LDAP server that holds the required directory service.

### Host Port

The standard port address for LDAP links is 389 and this should not need to be changed unless special circumstances exist.

### Base DN

This field allows you to enter the top level of the LDAP directory tree at which to start an LDAP search. An example Base DN value might be: "dc=catxip1000,dc=com"

### User field

Enter the LDAP database field that will be used to match each user name against. The details entered here will depend on the specific LDAP database being used - 'uid' or 'cn' are commonly used values.

### Anonymous Bind

If left unchecked then bind requests are sent with username (Base DN) and password (more suitable for Active Directory applications).

If checked, bind requests are anonymous (more suitable for Linux LDAP implementations).

## Admin Password and LDAP Support

Even if LDAP authentication is enabled, the 'admin' user is still authenticated locally, using the traditional authentication technique of matching to a locally sorted password.

### Active Directory authentication process

Typically, Active Directory deployments are not configured for anonymous binding. Hence, in our implementation of LDAP and Active Directory support for the Digital iPEPS we have opted have a single username and password to bind to the directory and authenticate.

In order to use the ARQ3 LDAP with Active Directory ensure that "Anonymous bind" is not checked in the LDAP configuration menu.

The process of authentication and associated LDAP transactions are as follows. A user enters the username and password in the VNC viewer authentication dialogue. This username and password is used as the "binddn" and "bindpw" in the "simple bind request" sent to the Active Directory server. Upon binding to the directory successfully, a LDAP search is performed for the same username under the specified User Field in the specified Base DN. If the the search is successful then the authentication is performed using the password entered by the user. If the password is accepted by the Active Directory server, then the process of authentication is completed and the user is unbound from the directory.

### Linux LDAP authentication process

In order to use the Digital iPEPS LDAP with Linux LDAP ensure that "Anonymous bind" is checked in the LDAP configuration menu.

The process of authentication and associated LDAP transactions are as follows. A user enters the username and password in the VNC viewer authentication dialogue. An anonymous "simple bind request" is then sent to the LDAP server. No username or password is sent at this stage. On binding to the directory successfully, a LDAP search is performed for the username, under the specified User Field and in the specified Base DN. If the the search is successful then the authentication is performed using the password entered by the user. If the password is accepted by the LDAP server, then the process of authentication is completed and the user is unbound from the directory.

### To get here

- 1 Using VNC viewer or a browser, log on as the 'admin' user.
- 2 Click the 'Configure' button in the top right corner.
- 3 Click the 'LDAP Configuration' option.



INSTALLATION

CONFIGURATION

OPERATION

FURTHER INFORMATION

INDEX

## Appendix 5 - Networking issues

Thanks to its robust security the Digital iPEPS offers you great flexibility in how it integrates into an existing network structure. The Digital iPEPS is designed to reside either on an internal network, behind a firewall/router or alternatively with its own direct Internet connection.

### Positioning Digital iPEPS in the network

Every network setup is different and great care needs to be taken when introducing a powerful device such as the Digital iPEPS into an existing configuration. A common cause of potential problems can be in clashes with firewall configurations. For this reason the Digital iPEPS is designed to be intelligent, flexible and secure. With the minimum of effort the Digital iPEPS can reside either behind the firewall or alongside with its own separate Internet connection.

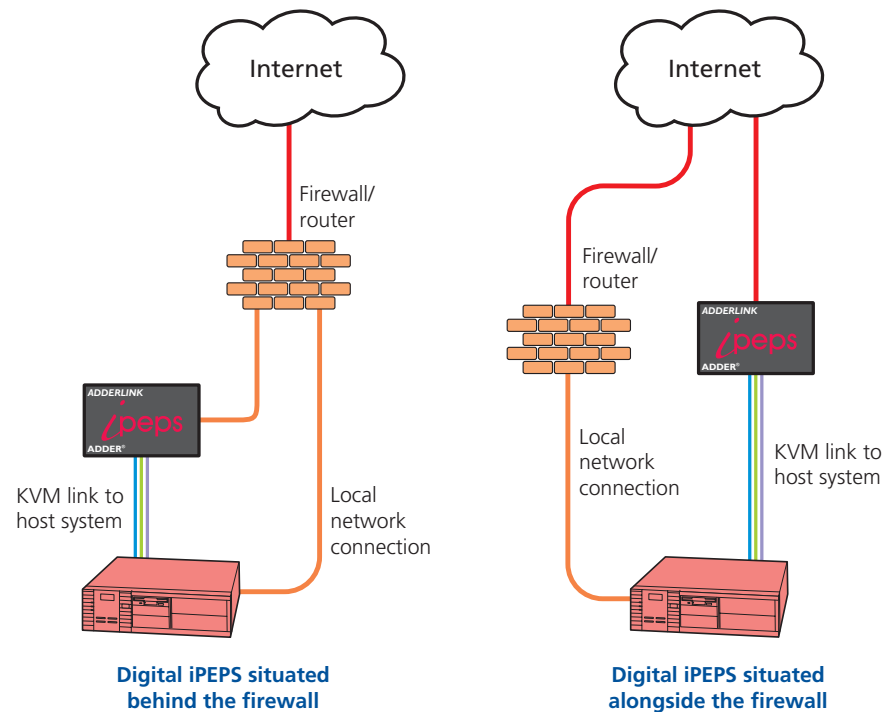

**IMPORTANT:** When the Digital iPEPS is accessible from the public Internet or dial up connection, you must ensure that sufficient [security measures](#) are employed.

### Placing Digital iPEPS behind a router or firewall

A possible point of contention between the Digital iPEPS and a firewall can occasionally arise over the use of IP ports. Every port through the firewall represents a potential point of attack from outside and so it is advisable to minimise the number of open ports. The Digital iPEPS usually uses two separate port numbers, however, these are easily changeable and can even be combined into a single port.

**IMPORTANT:** The correct configuration of routers and firewalls requires advanced networking skills and intimate knowledge of the particular network. Adder Technology cannot provide specific advice on how to configure your network devices and strongly recommend that such tasks are carried out by a qualified professional.

#### Port settings

As standard, the Digital iPEPS uses two ports to support its two types of viewer:

- **Port 80** for users making contact with a web browser, and
- **Port 5900** for those using the VNC viewer.

When these port numbers are used, VNC viewers and web browsers will locate the Digital iPEPS correctly using only its network address. The firewall/router must be informed to transfer traffic, requesting these port numbers, through to the Digital iPEPS.

#### When a web server is also on the local network

Port 80 is the standard port used by web (HTTP) servers. If the Digital iPEPS is situated within a local network that also includes a web server or any other device serving port 80 then, if you want to use the web browser interface from outside the local network environment, the HTTP port number of the Digital iPEPS must be changed.

When you change the HTTP port to anything other than 80, then each remote browser user will need to specify the port address as well as the IP address. For instance, if you set the HTTP port to '8000' and the IP address is '192.168.47.10' then browser users will need to enter:

**`http://192.168.47.10:8000`**

(Note the single colon that separates the IP address and the port number).

The firewall/router would also need to be informed to transfer all traffic to the new port number through to the Digital iPEPS.

#### If you need to change the VNC port number

If you change the VNC port to anything other than 5900, then each VNC viewer user will need to specify the port address as well as the IP address. For instance, if you set the VNC port to '11590' and the IP address is '192.168.47.10' then VNC viewer users will need to enter:

**`192.168.47.10::11590`**

(Note the *double* colons that separate the IP address and port number).

The firewall/router would also need to be informed to transfer all traffic to the new port number through to the Digital iPEPS.



INSTALLATION

CONFIGURATION

OPERATION

FURTHER INFORMATION

INDEX

## Addressing

When the Digital iPEPS is situated within the local network, you will need to give it an appropriate local IP address and IP network mask. This is achieved most easily using the DHCP server option which will apply these details automatically. If a DHCP server is not available on the network, then these details need to be applied manually in accordance with the network administrator.

The firewall/router must then be informed to route incoming requests to port 5900 or port 80 (if available) through to the local address being used by the Digital iPEPS.

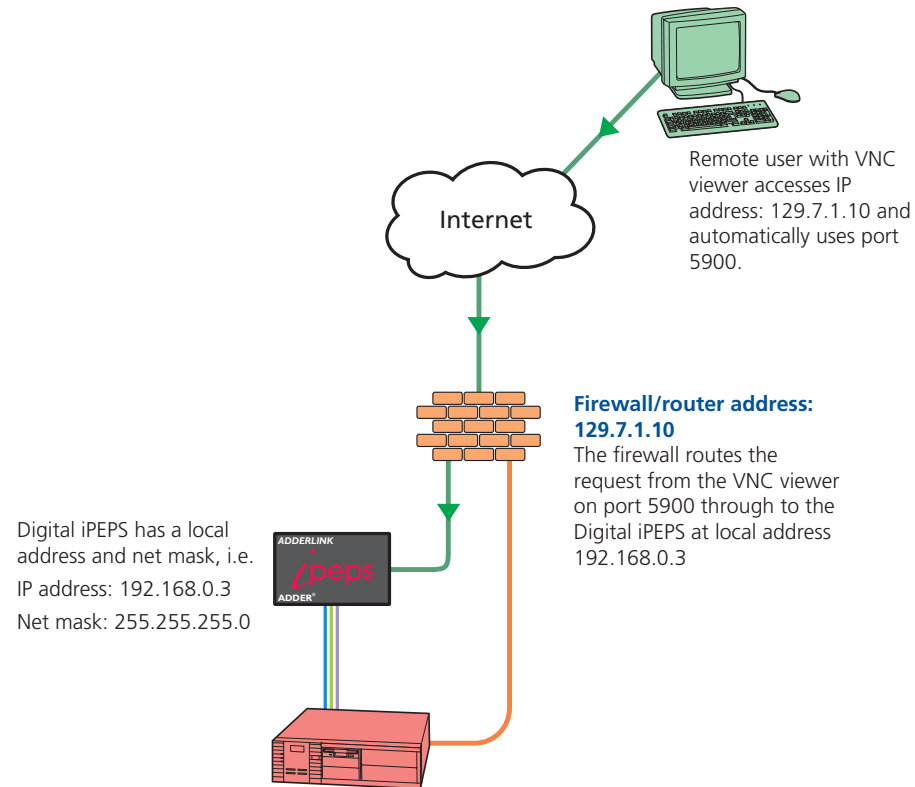

## To discover a DHCP-allocated IP address

Once a DHCP server has allocated an IP address, you will need to know it in order to access the Digital iPEPS via a network connection. To discover the allocated IP address:

- 1 Within [Network configuration](#), set the 'Use DHCP' option to 'Yes' and select 'Save'. Once the page is saved, the Digital iPEPS will contact the DHCP server and obtain a new address.
- 2 Re-enter the same 'Network configuration' screen where the new IP address and network mask should be displayed.

## DNS addressing

As with any other network device, you can arrange for your Digital iPEPS to be accessible using a name, rather than an IP address. This can be achieved in two main ways:

- For small networks that do not have a DNS (Domain Name System) server, edit the 'hosts' files on the appropriate remote systems. Using the hosts file, you can manually link the Digital iPEPS address to the required name.
- For larger networks, declare the IP address and required name to the DNS server of your local network.

The actual steps required to achieve either of these options are beyond the scope of this document.

## Placing Digital iPEPS alongside the firewall

Digital iPEPS is built from the ground-up to be secure. It employs a sophisticated 128bit public/private key system that has been rigorously analysed and found to be highly secure (a security white paper is available upon request from Adder Technology Ltd). Therefore, you can position the Digital iPEPS alongside the firewall and control a computer that is also IP connected within the local network.

*IMPORTANT: If you make the Digital iPEPS accessible from the public Internet, care should be taken to ensure that the maximum security available is activated. You are strongly advised to enable encryption and use a strong password. Security may be further improved by restricting client IP addresses, using a non-standard port number for access.*

### Ensuring sufficient security

The security capabilities offered by the Digital iPEPS are only truly effective when they are correctly used. An open or weak password or unencrypted link can cause security loopholes and opportunities for potential intruders. For network links in general and direct Internet connections in particular, you should carefully consider and implement the following:

- Ensure that [encryption is enabled](#).
- Ensure that you have selected [secure passwords](#) with at least 8 characters and a mixture of upper and lower case and numeric characters.
- Reserve the admin password for administration use only and use a non-admin user profile for day-to-day access.
- Use the latest Secure VNC viewer (this has more in-built security than is available with the Java viewer).
- Use non-standard [port numbers](#).
- Restrict the range of IP addresses that are allowed to access the Digital iPEPS to only those that you will need to use. To [restrict IP access](#).
- Do NOT Force VNC protocol 3.3.
- Ensure that the computer accessing the Digital iPEPS is clean of viruses and spyware and has up-to-date firewall and anti-virus software loaded that is appropriately configured.
- Avoid accessing the Digital iPEPS from public computers.

Security can be further improved by using the following suggestions:

- Place the Digital iPEPS behind a firewall and use port the numbers to route the VNC network traffic to an internal IP address.
- Review the activity log from time to time to check for unauthorised use.
- Lock your server consoles after they have been used.

A security white paper that gives further details is available upon request from Adder Technology Limited.

### Ports

In this configuration there should be no constraints on the port numbers because the Digital iPEPS will probably be the only device at that IP address. Therefore, maintain the HTTP port as 80 and the VNC port as 5900.

### Addressing

When the Digital iPEPS is situated alongside the firewall, it will require a public static IP address (i.e. one provided by your Internet service provider).

More addressing information:

[Discover DHCP-allocated addresses](#)

[DNS addressing](#)



## Appendix 6 - An introduction to IPv6

During the initial design of the Internet, 4.3 billion seemed like an impossibly large number of device addresses, possibly more than would ever be needed. It took nearly forty years, but finally the last remaining vacant address blocks within the current Internet Protocol scheme (called *IPv4*) were assigned in February 2011.

The Internet Protocol is a crucial element of Internet operation and the eventual exhaustion of unique addresses was predicted and acted upon many years ago. The replacement for IPv4 is known as *IPv6* and was defined in December 1998. Since then its uptake has been slow (reportedly used for less than 1% of Internet traffic in 2008) although this will increase rapidly as places within the incumbent system are exhausted.

### Vastly increased address space

The most notable feature of IPv6 is the size of its address space, put simply: It's massive. By using 128 bits to define each IPv6 address (rather than the 32 bits used in IPv4), there are now  $340 \times 10^{36}$  unique addresses (that's 340 trillion trillion trillion or as it is correctly known, 340 undecillion).

The larger address size of IPv6 requires a different manner of notation. Instead of the four decimal numbers separated by dots used for IPv4 (e.g. 192.168.0.1), IPv6 addresses consist of eight groups of four hexadecimal digits that are separated by colons (e.g. `2002:00a2:67be:0000:0000:0e82:8723:a144`) – each group of four digits represents 16 bits of the address. By necessity, IPv6 addresses are quite long and so there are a couple of techniques to help reduce this in certain cases:

- Where a group has one or more leading zeroes, these can be omitted. In the above example `00a2` and `0e82` can be written `a2` and `e82`, respectively.
- Where one or more consecutive groups consist solely of zeroes, they can be replaced with a double colon (`::`). In the above example, the fourth and fifth groups could be replaced with the double colon, so that the whole line could be reduced to: `2002:a2:67be::e82:8723:a144`. It is easy to return any such shortened address to the full version by replacing the double colons with sufficient groups of zeroes until the total number of groups is returned to eight. For this to work it is essential that only one set of consecutive zero groups within an address are replaced with a double colon.

### Standard subnet size

Thanks to the new huge address space, IPv6 does not need to wring every last drop out of each address range and so it handles address allocation in a different manner than its predecessor. Whereas IPv4 uses subnets of varying sizes (using the Subnet Mask entry to define the size of each subnet), IPv6 subnets are (almost) all set to a standard size. A full 64 bits are used to define each subnet, which means that every standard IPv6 subnet has use of an address space that is the square of the entire IPv4 address space (that's  $1.8 \times 10^{19}$  addresses per subnet). In those subnets, all addresses are valid host locations; gone are special address formats for particular uses, such as broadcast traffic. Also, now that all standard subnets are the same size, the subnet mask is another item that is made redundant under IPv6.

### Address allocation

Every device attached to an IPv6 network usually has more than one address type. The two most common types are called a *link-local address* and a *global address* and these can be assigned in a number of ways.

In IPv4, device addresses are most commonly assigned either manually or by using a Dynamic Host Configuration Protocol server (DHCP). IPv6 also offers manual addressing and DHCP (now called DHCPv6 and fully supported by the Digital iPEPS unit), but also allows devices to automatically configure their own addresses using a series of steps defined as *StateLess Address AutoConfiguration* (or *SLAAC*). The key parts of the SLAAC procedure occur roughly as follows:

- The IPv6 compliant device creates a *tentative local identifier* which is usually derived from its fixed unique hardware identifier (or MAC address). The local identifier is 64 bits in length (the lower half of the full 128 bit address) and this is one of the advantages of having a fixed subnet size; it is very straightforward to automatically figure out the boundaries and contents of the local network. This is exactly what the device does next with its tentative local identifier.
- The device uses the *Neighbor Discovery Protocol* (part of the *Internet Control Message Protocol* suite – *IMCPv6*) to check within the local network whether its tentative local identifier is being used by any other device. If it is, then the device will create a new one and start the process again. If the local identifier is unique within the local network, it is then combined with the standard link-local prefix (`fe80::`) to form a valid link-local address. At this stage the address is valid only for communication within the local network. The next stage is to replace the link-local prefix with a global prefix and then carry out a similar procedure in order to prevent address duplication, resulting in a validated global address.

*continued*

## Mixing IPv4 and IPv6

Although IPv6 is based upon, and shares a number of similarities with IPv4, there are great differences in their address spaces and other key details which mean that they are not directly compatible. This means that while computers and their operating systems can support both types, IPv4 and IPv6 networks exist essentially as two parallel, independent entities with numerous cross over points (known as *relay routers*). For the foreseeable future, while both versions coexist, exchanging traffic between them will require many relay routers and various transition techniques.

One such technique involves *IPv4-mapped IPv6 addresses*. These are used in operating systems and applications that transparently support both IP formats. In such cases IPv6 will be the native format with IPv4 fully supported whenever necessary. When an IPv4 address must be incorporated, it is placed into a special IPv6 address that has its first 80 bits set to zero and the next 16 bits set to one. The remaining 32 bits are where the IPv4 address is embedded. When written, the address is an amalgam of the two network types - `::ffff:192.0.2.128`



INSTALLATION

CONFIGURATION

OPERATION

FURTHER  
INFORMATION

INDEX

## Appendix 7 - The KVMADMIN utility

Particularly useful for complex Digital iPEPS configurations and the control of remote installations, KVMADMIN is a powerful administration tool.

KVMADMIN is based upon the established VNC viewer and uses the same security system. Rather than a graphical interface such as the standard viewer, KVMADMIN uses command line control to provide the following administration facilities:

- Discover and adjust the Digital iPEPS configuration, including host systems,
- Save and restore the Digital iPEPS configuration,
- Set user names and passwords,
- Download the event log,

The use of KVMADMIN is strictly limited to the 'admin' user and for security purposes it is not possible to retrieve user names or passwords from the Digital iPEPS.

To use KVMADMIN you require the IP address and admin password of the Digital iPEPS unit. The command line is as follows:

```
kvmadmin <command> <ip address> [<parameters>]
```

where *<command>* is one of the following:

- *-setconfig <config-file>*
- *-getconfig <config-file>*
- *-setusers <csv-file>*
- *-getlog <log-file>*
- *-gethosts <csv-file>*
- *-sethosts <csv-file>*
- *-setmodes <csv-file>*

For instance, the command line:

```
kvmadmin -getconfig kvm1.cfg 192.168.2.1
```

... downloads the current configuration from the Digital iPEPS unit at the given address and stores it in the local file *kvm1.cfg*.

Whereas the command line:

```
kvmadmin -setusers users.csv 192.168.2.1
```

... configures the usernames and passwords for the same unit from the local file *users.csv*.

For more information about KVMADMIN, please refer to the user notes supplied with the utility.



INSTALLATION

CONFIGURATION

OPERATION

FURTHER  
INFORMATION

INDEX

## Appendix 8 - Known working video modes

640 x 480p at 60Hz  
640 x 480p at 67Hz  
640 x 480p at 72Hz  
640 x 480p at 75Hz  
640 x 480p at 85Hz  
720 x 400p at 70Hz  
800 x 600p at 56Hz  
800 x 600p at 60Hz  
800 x 600p at 72Hz  
800 x 600p at 75Hz  
800 x 600p at 85Hz  
832 x 624p at 75Hz  
1024 x 768p at 60Hz  
1024 x 768p at 70Hz  
1024 x 768p at 75Hz  
1024 x 768p at 85Hz  
1152 x 864p at 60Hz  
1152 x 864p at 75Hz  
1152 x 870p at 75Hz  
1280 x 960p at 60Hz  
1280 x 1024p at 67Hz  
1280 x 1024p at 75Hz  
1280 x 1024p at 85Hz  
1600 x 1200p at 60Hz  
1920 x 1080p at 60Hz  
1920 x 1200p at 60Hz with reduced blanking.

*Note: 1366x1024@60Hz and 1366x768@60Hz are not supported.*

## Appendix 9 - Product compatibility

Digital iPEPS is compatible with the following Adder products:

- AdderLink Infinity 1000 and AdderLink Infinity 2000 receivers to allow a VNC connection into an Infinity Matrix.
- AdderView AV4PRO KVM switch to allow remote access to four USB/DVI computers.

Note: Digital iPEPS is NOT compatible with the AdderView AV8PRO KVM switch.



INSTALLATION

CONFIGURATION

OPERATION

FURTHER  
INFORMATION

INDEX

# Appendix 10 – Hotkey sequences and Adder Port Direct



Digital iPEPS allows you to enter commands suitable for any KVM switch in order to choose from up to 128 host systems. These switching commands can take the form of hotkey sequences that emulate standard keypress combinations or, for KVM switches that support the *Adder Port Direct* format, merely basic port numbers.

## Hotkey sequences

Almost any combination of keypresses can be emulated using the following notations:

- + means press down the key that follows;
- means release the key that follows
- +– means press and then release the key that follows
- \* means add a delay. The standard delay period is 250ms, however, if a number immediately follows the asterisk, this will define an alternate delay period (in milliseconds)

### Notes

- The entries are not case sensitive.
- All characters can be entered using their ASCII codes, from 32 to 126 (i.e. A,B,C, ... 1,2,3 etc.) with the exception of the special characters above.
- It is not necessary to specify all keys to be released at the end because they are all released automatically after the last code.
- A number of KVM switches from alternative manufacturers use hot key sequences that begin with a press/release of either the Scroll Lock or Ctrl keys. These often require a delay between the initial key press and the channel number to allow the switch to respond. A 500ms delay is usually sufficient.

### Examples

To send the command *Ctrl + Alt 4* you should use the following: `+Ctrl+Alt+4`.

To send the command *Ctrl + Alt 12* you should use the following:

`+Ctrl+ALT+–1+2`

(the '+–1' entry causes the 1 key to be pressed and released before the 2 key is pressed).

To send the command *Scroll lock 1 + Enter* (with a 500ms delay) you should use the following: `+–Scr*500+1+Ent`

## Main control keys (see 'Using abbreviations')

Backspace | Tab | Return | Enter | Ctrl | Alt | Win | Shift | LShift | RShift  
LCtrl | RCtrl | LAlt | AltGr | RAlt | LWin | RWin | Menu | Escape | Space  
CapsLock | NumLock | PrintScreen | Scrolllock

## Math operand keys (see 'Using abbreviations')

Add (Plus) | Subtract (Minus) | Multiply

## Central control keys (see 'Using abbreviations')

Insert | Delete | Home | End | PageUp | PageDown  
Up | Down | Left | Right | Print | Pause

## Keypad keys (see 'Using abbreviations')

KP\_Insert | KP\_Delete | KP\_Home | KP\_End | KP\_PageUp  
KP\_PageDown | KP\_Up | KP\_Down | KP\_Left | KP\_Right | KP\_Enter  
KP\_Add | KP\_Subtract | KP\_Divide | KP\_Multiply  
KP\_0 to KP\_9

## Function keys

F1 | F2 | F3 | F4 | F5 | F6 | F7 | F8 | F9 | F10 | F11 | F12

## Creating macro sequences

Hot key macro sequences can be up to 256 characters long. All keys are assumed to be released at the end of a line, however, you can also determine that a key is pressed and released within a sequence. Any of the following three examples will send a command that emulates and a press and release of the Scroll Lock key:

+SCROLL-SCROLL  
+-SCROLL  
+SCROLL-

Example:

`+-SCROLL+-SCROLL+1+ENTER`

Press and release scroll twice, press 1 then enter then release all keys (equivalent definition is `+SCROLL-SCROLL+SCROLL-SCROLL+1+ENTER-1-ENTER`)

## Using abbreviations

To reduce the length of the key definitions, any unique abbreviation for a key can be used. For example: "scroll", "scr" and even "sc" all provide an identifiable match for "ScrollLock" whereas "en" could not be used because it might mean "Enter" or "End" ("ent" would be suitable for "Enter").

*Note: Hotkey sequences and abbreviations are not case sensitive.*

For information about where to enter these codes, please see the sections [Host configuration](#) or [Keyboard control](#).

## Adder Port Direct

Adder Port Direct is totally transparent communication system that allows supporting KVM switches and remote access devices to communicate with each other. Using the keyboard connections that link each device, Adder Port Direct allows:

- A controlling device to provide address details of the required port, the user's name and access rights, mouse calibration and video mode information.
- A controlled device to confirm the address and other details of the current port.

Such communication simplifies both the configuration and selection of systems, especially within a complex cascade structure. Adder Port Direct provides excellent security control to prevent users from accessing systems for which they do not access rights ('sideways movement') because each unit is fully informed of each user's precise access rights.

### Port/host addressing using Adder Port Direct

When adding new computers to the Hosts list, the option '*Add entry for unrecognised host*' is provided to automatically add new entries if a port is visited that does not already have a matching host entry. This is a useful option for simple KVM switch configurations, but should be used with care when complex cascades of switches are being used as it may lead to more host entries being added than are strictly necessary.

Additionally, you can specify the port number of the required system using the same format as if controlling the KVM switch directly. Port numbers **MUST** be entered within square brackets and can be specified to a maximum of four cascaded levels.

### Examples

- [16]** selects port 16 and is equivalent to the hotkey sequence  
`+CTRL+ALT+-1+6`
- [4105]** selects port 5 on a KVM switch that is cascaded through port group 41

## Warranty

Adder Technology Ltd warrants that this product shall be free from defects in workmanship and materials for a period of two years from the date of original purchase. If the product should fail to operate correctly in normal use during the warranty period, Adder will replace or repair it free of charge. No liability can be accepted for damage due to misuse or circumstances outside Adder's control. Also Adder will not be responsible for any loss, damage or injury arising directly or indirectly from the use of this product. Adder's total liability under the terms of this warranty shall in all circumstances be limited to the replacement value of this product.

If any difficulty is experienced in the installation or use of this product that you are unable to resolve, please contact your supplier.

## Safety information

- For use in dry, oil free indoor environments only.
- Warning - live parts contained within power adapter.
- No user serviceable parts within power adapter - do not dismantle.
- Plug the power adapter into a socket outlet close to the module that it is powering.
- Replace the power adapter with a manufacturer approved type only.
- Do not use the power adapter if the power adapter case becomes damaged, cracked or broken or if you suspect that it is not operating properly.
- If you use a power extension cord with the Digital iPEPS, make sure the total ampere rating of the devices plugged into the extension cord does not exceed the cord's ampere rating. Also, make sure that the total ampere rating of all the devices plugged into the wall outlet does not exceed the wall outlet's ampere rating.
- Do not attempt to service the Digital iPEPS yourself.

### Safety considerations when using power switches with Digital iPEPS

- Follow the manufacturer's instructions when setting up and using power switching products.
- Always ensure that the total ampere rating of the devices plugged into the power switching product does not exceed the power switching product's ampere rating. Also, make sure that the total ampere rating of all the devices plugged into the wall outlet does not exceed the wall outlet's ampere rating.

### General Public Licence (Linux)

The Digital iPEPS runs an embedded version of the Linux operating system, licensed under the GNU General Public Licence. To obtain the source code for the open-source components of the system visit:

<http://www.adventiq.com/products/ARQ3/gpl.html>



INSTALLATION

CONFIGURATION

OPERATION

FURTHER  
INFORMATION

INDEX

# End user licence agreement

PLEASE READ THIS AGREEMENT CAREFULLY. THIS AGREEMENT CONCERNS ENHANCED VNC VIEWER SOFTWARE (“the SOFTWARE”) FOR USE WITH THE Digital iPEPS PRODUCT (“the PRODUCT”). THE SOFTWARE IS PROVIDED TO ENABLE YOU TO OPERATE THE PRODUCT. BY USING ALL OR ANY PORTION OF THE SOFTWARE YOU ACCEPT ALL THE TERMS AND CONDITIONS OF THIS AGREEMENT. IF YOU DO NOT ACCEPT ALL THE TERMS AND CONDITIONS OF THIS AGREEMENT THEN DO NOT USE THE SOFTWARE. BY USING ANY UPDATED VERSION OF THE SOFTWARE WHICH MAY BE MADE AVAILABLE, YOU ACCEPT THAT THE TERMS OF THIS AGREEMENT APPLY TO SUCH UPDATED SOFTWARE.

## 1. Intellectual Property Rights

The Software and its structure and algorithms are protected by copyright and other intellectual property laws, and all intellectual property rights in them belong to RealVNC Limited (“RealVNC”), a United Kingdom Limited Company, or are licensed to it. You may not reproduce, publish, transmit, modify, create derivative works from, publicly display the Software or part thereof. Copying or storing or using the Software other than as permitted in Clause 2 is expressly prohibited unless you obtain prior written permission from RealVNC.

## 2. Permitted and Prohibited Uses

- 2.1 During the term of this Agreement and as long as you comply with the terms of this agreement, you may use the Software only with the Product for your personal use or for the internal use of your business. You may make as many copies of the Software as you require for your own internal business purposes only and for archival purposes. You are expressly prohibited from distributing the Software in any format, in whole or in part, for sale, or for commercial use or for any unlawful purpose.
- 2.2 You may not rent, lease or otherwise transfer the Software or allow it to be copied. Unless permitted by law, you may not reverse engineer, decompile or disassemble the Software.

## 3. Warranty

REALVNC DOES NOT WARRANT ANY RESULTS OBTAINED USING THE SOFTWARE. TO THE EXTENT PERMITTED BY LAW, REALVNC DISCLAIMS ALL OTHER WARRANTIES ON THE SOFTWARE, EITHER EXPRESS OR IMPLIED, INCLUDING BUT NOT LIMITED TO THE IMPLIED WARRANTIES OF MERCHANTABILITY, NON-INFRINGEMENT OF THIRD PARTY RIGHTS AND FITNESS FOR PARTICULAR PURPOSE.

## 4. Limitation on Liability

UNDER NO CIRCUMSTANCES SHALL REALVNC BE LIABLE FOR ANY CONSEQUENTIAL INDIRECT OR INCIDENTAL DAMAGES WHATSOEVER INCLUDING LOST PROFITS OR SAVINGS ARISING OUT OF THE USE OF THE SOFTWARE, THE SERVICE OR THE INFORMATION, RELIANCE ON THE DATA PRODUCED OR INABILITY TO USE THE SOFTWARE, THE SERVICE OR THE INFORMATION EVEN IF REALVNC HAS BEEN ADVISED OF THE POSSIBILITY OF SUCH DAMAGES. BECAUSE SOME STATES AND COUNTRIES DO NOT ALLOW THE EXCLUSION OR LIMITATION OF LIABILITY FOR CONSEQUENTIAL OR INCIDENTAL DAMAGES, THE ABOVE LIMITATION MAY NOT APPLY TO YOU. NOTHING IN THIS AGREEMENT LIMITS LIABILITY FOR DEATH OR PERSONAL INJURY ARISING FROM A PARTY’S NEGLIGENCE OR FROM FRAUDULENT MISREPRESENTATION ON THE PART OF A PARTY

## 5. Export Control

The United States and other countries control the export of Software and information. You are responsible for compliance with the laws of your local jurisdiction regarding the import, export or re-export of the Software, and agree to comply with such restrictions and not to export or re-export the Software where this is prohibited. By downloading the Software, you are agreeing that you are not a person or entity to which such export is prohibited.

## 6. Term and Termination

This licence shall continue in force unless and until it is terminated by RealVNC by e-mail notice to you, if it reasonably believes that you have breached a material term of this Agreement

In the case above, you must delete and destroy all copies of the Software in your possession and control and overwrite any electronic memory or storage locations containing the Software.

## 7. General Terms

- 7.1 The construction, validity and performance of this Agreement shall be governed in all respects by English law, and the Parties agree to submit to the exclusive jurisdiction of the English courts.
- 7.2 If any provision of this agreement is found to be invalid by any court having competent jurisdiction, the invalidity of such provision shall not affect the validity of the remaining provisions of this agreement, which shall remain in full force and effect.
- 7.3 No waiver of any term of this agreement shall be deemed a further or continuing waiver of such term or any other term.
- 7.4 This agreement constitutes the entire agreement between you and RealVNC.



INSTALLATION

CONFIGURATION

OPERATION

FURTHER INFORMATION

INDEX



## Radio Frequency Energy

A Category 5 (or better) twisted pair cable must be used to connect the Digital iPEPS unit in order to maintain compliance with radio frequency energy emission regulations and ensure a suitably high level of immunity to electromagnetic disturbances.

All other interface cables used with this equipment must be shielded in order to maintain compliance with radio frequency energy emission regulations and ensure a suitably high level of immunity to electromagnetic disturbances.

## European EMC directive 2004/108/EC

This equipment has been tested and found to comply with the limits for a class A computing device in accordance with the specifications in the European standard EN55022. These limits are designed to provide reasonable protection against harmful interference. This equipment generates, uses and can radiate radio frequency energy and if not installed and used in accordance with the instructions may cause harmful interference to radio or television reception. However, there is no guarantee that harmful interference will not occur in a particular installation. If this equipment does cause interference to radio or television reception, which can be determined by turning the equipment on and off, the user is encouraged to correct the interference with one or more of the following measures: (a) Reorient or relocate the receiving antenna. (b) Increase the separation between the equipment and the receiver. (c) Connect the equipment to an outlet on a circuit different from that to which the receiver is connected. (d) Consult the supplier or an experienced radio/TV technician for help.

## FCC Compliance Statement (United States)

This equipment generates, uses and can radiate radio frequency energy and if not installed and used properly, that is, in strict accordance with the manufacturer's instructions, may cause interference to radio communication. It has been tested and found to comply with the limits for a class A computing device in accordance with the specifications in Subpart J of part 15 of FCC rules, which are designed to provide reasonable protection against such interference when the equipment is operated in a commercial environment. Operation of this equipment in a residential area may cause interference, in which case the user at his own expense will be required to take whatever measures may be necessary to correct the interference. Changes or modifications not expressly approved by the manufacturer could void the user's authority to operate the equipment.

## Canadian Department of Communications RFI statement

This equipment does not exceed the class A limits for radio noise emissions from digital apparatus set out in the radio interference regulations of the Canadian Department of Communications.

*Le présent appareil numérique n'émet pas de bruits radioélectriques dépassant les limites applicables aux appareils numériques de la classe A prescrites dans le règlement sur le brouillage radioélectriques publié par le ministère des Communications du Canada.*



INSTALLATION

CONFIGURATION

OPERATION

FURTHER INFORMATION

INDEX



Web: [www.adder.com](http://www.adder.com)

Contact: [www.adder.com/contact-details](http://www.adder.com/contact-details)

Support: [forum.adder.com](http://forum.adder.com)

INSTALLATION

CONFIGURATION

OPERATION

FURTHER  
INFORMATION

INDEX

# Index



## A

- Access control
  - configuration 39
- Access mode
  - shared & private 15
- Addressing
  - DNS 46
  - network issues 46
- Advanced unit configuration 34,35
- Auto calibrate 15
- Auto select 29

## B

- Browser
  - viewer options 10,29

## C

- Cable specifications 53
- Calibrate
  - mouse 15
  - screen 15
- Configuration
  - advanced mouse 18
  - initial steps 13
  - menu bar edit 16
- Connections
  - host computer 7
  - modem 9
  - network port 8
- Control menus 13
- Controls
  - viewer options 17
- Control strings
  - power switching 42

## D

- DHCP
  - discovering allocations 46
  - remote setting 37,38
- DNS addressing 46

## E

- End user licence 56

## F

- Factory default 23
- Firewall 45
- Firmware
  - current version 33
- Flash upgrade 12
- Full screen mode
  - escape from (F8) 13

## G

- Gateway
  - remote setting 37,38
- Gui editing 16

## H

- Hextile 29
- Host computer
  - changing between 14
  - configuration 41
  - connecting 7
  - power switching setup 42
  - selection 14
- Hotkey sequences 53
  - codes and macros 53
- HTTP port
  - remote setting 37,38
  - when altered 45

## I

- Initial configuration 10
- IP access control 37,38,39
- IP address
  - IPv6 48
  - remote setting 37
- IP gateway 37,38
- IP network mask 37
- IP network port 4
  - connecting 8
- IPv4 48
- IPv6 48

## K

- Keyboard codes
  - sending 19
- Keyboard Control 19
- Keyboard layout
  - remote setting 33
- KVMADMIN utility 50

## L

- Local network
  - connection 45
- Logging 43
- Log on 11

## M

- MAC address 36,37,38
- Menu bar
  - viewer window 13
- Menu bar editing 16
- Menu key
  - changing 25,26
- Modem
  - connecting 9
- Mouse
  - advanced configuration 18
  - calibration 15
  - control 17
  - resync 15,17

## N

- Network configuration 37,38
- Networking issues 45
- Network port
  - connecting 8

## P

- Password
  - remote logon 11
- Power strings
  - for switching 42
- Power switching
  - configuration 13,42
  - control sequences 42
  - on & off select 15
  - user permissions 31
  - via viewer 15
- Private
  - access mode 15

## R

- Raw 29
  - Refresh screen 17
  - Remote configuration
    - advanced unit configuration 34,35
    - host configuration 41
    - logging and status 43
    - network configuration 37,38
    - setting IP access control 39
    - unit configuration 33
    - user accounts 31
  - Resetting 23
  - Resync mouse 17
  - Router 45
- ## S
- Safety information 55
  - Screen
    - best resolution 13
    - navigation 13
    - refresh 17
  - Security
    - ensuring 47
  - Server
    - configuration 41
  - Shared
    - access mode 15
  - Single mouse mode 17
  - Slow connections
    - optimising for 13
  - Sound control 20
  - StateLess Address AutoCon-figuration 48
  - Supplied items 5
  - Syslog 43,44

INSTALLATION

CONFIGURATION

OPERATION

FURTHER INFORMATION

INDEX

## T

- Threshold setting 19
- Time & date configuration 36
- Troubleshooting 24

## U

- Unit Configuration 33
- Unit name
  - remote setting 33
- User accounts 31
- User configuration 31,32
- Username
  - remote logon 11

## V

- Video settings 18,19
- Viewer window 13
  - menu bar editing 16
- Virtual Media 3
- VNC port
  - remote setting 37,38
  - when altered 45
- VNC viewer
  - connection options 25
  - window options 28

## W

- Warranty 55
- Web browser
  - viewer options 10,29

## Z

- ZRLE 29

INSTALLATION

CONFIGURATION

OPERATION

FURTHER  
INFORMATION

INDEX