



REPUBLIC OF
GAMERS

ROG SWIFT PG65U

ASUS

HDMI
HIGH DEFINITION MULTIMEDIA INTERFACE

First Edition

July 2019

Copyright © 2019 ASUSTeK COMPUTER INC. All Rights Reserved.

No part of this manual, including the products and software described in it, may be reproduced, transmitted, transcribed, stored in a retrieval system, or translated into any language in any form or by any means, except documentation kept by the purchaser for backup purposes, without the express written permission of ASUSTeK COMPUTER INC. ("ASUS").

Product warranty or service will not be extended if: (1) the product is repaired, modified or altered, unless such repair, modification or alteration is authorized in writing by ASUS; or (2) the serial number of the product is defaced or missing.

ASUS PROVIDES THIS MANUAL "AS IS" WITHOUT WARRANTY OF ANY KIND, EITHER EXPRESS OR IMPLIED, INCLUDING BUT NOT LIMITED TO THE IMPLIED WARRANTIES OR CONDITIONS OF MERCHANTABILITY OR FITNESS FOR A PARTICULAR PURPOSE. IN NO EVENT SHALL ASUS, ITS DIRECTORS, OFFICERS, EMPLOYEES OR AGENTS BE LIABLE FOR ANY INDIRECT, SPECIAL, INCIDENTAL, OR CONSEQUENTIAL DAMAGES (INCLUDING DAMAGES FOR LOSS OF PROFITS, LOSS OF BUSINESS, LOSS OF USE OR DATA, INTERRUPTION OF BUSINESS AND THE LIKE), EVEN IF ASUS HAS BEEN ADVISED OF THE POSSIBILITY OF SUCH DAMAGES ARISING FROM ANY DEFECT OR ERROR IN THIS MANUAL OR PRODUCT.

SPECIFICATIONS AND INFORMATION CONTAINED IN THIS MANUAL ARE FURNISHED FOR INFORMATIONAL USE ONLY, AND ARE SUBJECT TO CHANGE AT ANY TIME WITHOUT NOTICE, AND SHOULD NOT BE CONSTRUED AS A COMMITMENT BY ASUS. ASUS ASSUMES NO RESPONSIBILITY OR LIABILITY FOR ANY ERRORS OR INACCURACIES THAT MAY APPEAR IN THIS MANUAL, INCLUDING THE PRODUCTS AND SOFTWARE DESCRIBED IN IT.

Products and corporate names appearing in this manual may or may not be registered trademarks or copyrights of their respective companies, and are used only for identification or explanation and to the owners' benefit, without intent to infringe.

Contents

Notices.....	iv
Safety information	v
Care & Cleaning	vi
Takeback Services.....	vii

Chapter 1: Product introduction

1.1	Welcome!	1-1
1.2	Package contents.....	1-1
1.3	Monitor introduction	1-2
1.3.1	Front view	1-2
1.3.2	Back view.....	1-3
1.3.3	Remote control.....	1-4
1.3.4	Other Function(s)	1-5

Chapter 2: Setup

2.1	Detaching the base (for VESA wall mount)	2-1
2.2	Cable management	2-1
2.3	Installing the Aura Sync ROG logo projector.....	2-2
2.4	Connecting the cables.....	2-2
2.5	Turning on the monitor.....	2-3

Chapter 3: General instructions

3.1	OSD (On-Screen Display) menu	3-1
3.1.1	How to reconfigure.....	3-1
3.1.2	OSD function introduction.....	3-2
3.2	ASUS Aura.....	3-9
3.3	Specifications summary.....	3-10
3.4	Troubleshooting (FAQ).....	3-11
3.5	Supported operating mode	3-12

Notices

Federal Communications Commission Statement

This device complies with Part 15 of the FCC Rules. Operation is subject to the following two conditions:

- This device may not cause harmful interference, and
- This device must accept any interference received including interference that may cause undesired operation.

This equipment has been tested and found to comply with the limits for a Class B digital device, pursuant to Part 15 of the FCC Rules. These limits are designed to provide reasonable protection against harmful interference in a residential installation. This equipment generates, uses and can radiate radio frequency energy and, if not installed and used in accordance with the instructions, may cause harmful interference to radio communications. However, there is no guarantee that interference will not occur in a particular installation. If this equipment does cause harmful interference to radio or television reception, which can be determined by turning the equipment off and on, the user is encouraged to try to correct the interference by one or more of the following measures:

- Reorient or relocate the receiving antenna.
- Increase the separation between the equipment and receiver.
- Connect the equipment into an outlet on a circuit different from that to which the receiver is connected.
- Consult the dealer or an experienced radio/TV technician for help.



The use of shielded cables for connection of the monitor to the graphics card is required to assure compliance with FCC regulations. Changes or modifications to this unit not expressly approved by the party responsible for compliance could void the user's authority to operate this equipment.

Canadian Department of Communications Statement

This digital apparatus does not exceed the Class B limits for radio noise emissions from digital apparatus set out in the Radio Interference Regulations of the Canadian Department of Communications.

This class B digital apparatus complies with Canadian ICES-003.

This Class B digital apparatus meets all requirements of the Canadian Interference - Causing Equipment Regulations.

Cet appareil numérique de la classe B respecte toutes les exigences du Règlement sur le matériel brouiller du Canada.



Safety information

- Before setting up the monitor, carefully read all the documentation that came with the package.
- To prevent fire or shock hazard, never expose the monitor to rain or moisture.
- Never try to open the monitor cabinet. The dangerous high voltages inside the monitor may result in serious physical injury.
- If the power supply is broken, do not try to fix it by yourself. Contact a qualified service technician or your retailer.
- Before using the product, make sure all cables are correctly connected and the power cables are not damaged. If you detect any damage, contact your dealer immediately.
- Slots and openings on the back or top of the cabinet are provided for ventilation. Do not block these slots. Never place this product near or over a radiator or heat source unless proper ventilation is provided.
- The monitor should be operated only from the type of power source indicated on the label. If you are not sure of the type of power supply to your home, consult your dealer or local power company.
- Use the appropriate power plug which complies with your local power standard.
- Do not overload power strips and extension cords. Overloading can result in fire or electric shock.
- Avoid dust, humidity, and temperature extremes. Do not place the monitor in any area where it may become wet. Place the monitor on a stable surface.
- Unplug the unit during a lightning storm or if it will not be used for a long period of time. This will protect the monitor from damage due to power surges.
- Never push objects or spill liquid of any kind into the slots on the monitor cabinet.
- To ensure satisfactory operation, use the monitor only with UL listed computers which have appropriate configured receptacles marked between 100-240V AC.
- If you encounter technical problems with the monitor, contact a qualified service technician or your retailer.
- Adjustment of the volume control as well as the equalizer to other settings than the center position may increase the ear-/headphones output voltage and therefore the sound pressure level.



This symbol of the crossed out wheeled bin indicates that the product (electrical, electronic equipment, and mercury-containing button cell battery) should not be placed in municipal waste. Please check local regulations for disposal of electronic products.

AEEE yönetmeliğine uygundur

Care & Cleaning

- Before you lift or reposition your monitor, it is better to disconnect the cables and power cord. Follow the correct lifting techniques when positioning the monitor. When lifting or carrying the monitor, grasp the edges of the monitor. Do not lift the display by the stand or the cord.
- Cleaning. Turn your monitor off and unplug the power cord. Clean the monitor surface with a lint-free, non-abrasive cloth. Stubborn stains may be removed with a cloth dampened with mild cleaner.
- Avoid using a cleaner containing alcohol or acetone. Use a cleaner intended for use with the monitor. Never spray cleaner directly on the screen, as it may drip inside the monitor and cause an electric shock.

The following symptoms are normal with the monitor:

- The screen may flicker during the initial use due to the nature of the fluorescent light. Turn off the Power Switch and turn it on again to make sure that the flicker disappears.
- You may find slightly uneven brightness on the screen depending on the desktop pattern you use.
- When the same image is displayed for hours, an afterimage of the previous screen may remain after switching the image. The screen will recover slowly or you can turn off the Power Switch for hours.
- When the screen becomes black or flashes, or cannot work anymore, contact your dealer or service center to fix it. Do not repair the screen by yourself!

Conventions used in this guide



WARNING: Information to prevent injury to yourself when trying to complete a task.



CAUTION: Information to prevent damage to the components when trying to complete a task.



IMPORTANT: Information that you **MUST** follow to complete a task.



NOTE: Tips and additional information to aid in completing a task.

Where to find more information

Refer to the following sources for additional information and for product and software updates.

1. **ASUS websites**

The ASUS websites worldwide provide updated information on ASUS hardware and software products. Refer to <http://www.asus.com>

2. **Optional documentation**

Your product package may include optional documentation that may have been added by your dealer. These documents are not part of the standard package.

Takeback Services

ASUS recycling and takeback programs come from our commitment to the highest standards for protecting our environment. We believe in providing solutions for our customers to be able to responsibly recycle our products, batteries and other components as well as the packaging materials.

Please go to <http://csr.asus.com/english/Takeback.htm> for detail recycling information in different region.

1.1 Welcome!

Thank you for purchasing the ROG Gaming Monitor!

The latest widescreen LCD monitor from ASUS provides a broader, brighter and crystal-clear display, plus a host of features that enhance your viewing experience.

With these features, you can enjoy the convenience and delightful visual experience that the monitor brings to you!

1.2 Package contents

Check your package for the following items:

- ✓ LCD monitor
- ✓ Monitor base
- ✓ Quick start guide
- ✓ Warranty card
- ✓ Remote control
- ✓ Power cord
- ✓ DP cable
- ✓ HDMI cable
- ✓ USB cable
- ✓ Aura Sync ROG logo projector
- ✓ Cable management hook
- ✓ Hexagon key
- ✓ Calibration report



If any of the above items is damaged or missing, contact your retailer immediately.



If no signal is detected for around 12 minutes, the monitor automatically enters saving mode.



It is recommended that you set the DisplayPort Deep Sleep and HDMI Deep Sleep functions to "OFF".

1.3 Monitor introduction

1.3.1 Front view

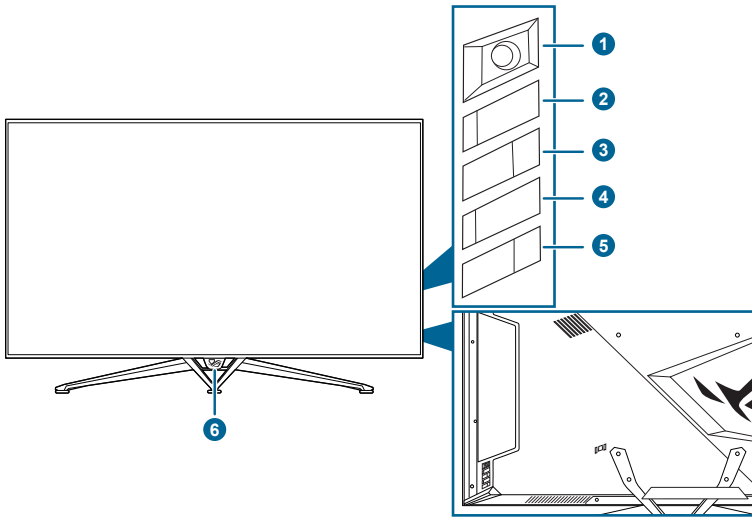

1. 5-way () button
 - Turns on the OSD menu. Enacts the selected OSD menu item.
 - Increases/Decreases values or moves your selection up/down/left/right.
 - Turns on the OSD menu when the monitor enters standby mode.
2. Hotkey button 1
 - Input Select hotkey.
 - Turns on the OSD menu when the monitor enters standby mode.
3. Hotkey button 2
 - Brightness hotkey.
 - Turns on the OSD menu when the monitor enters standby mode.
4. Exit button
 - Exits the OSD menu item.
 - Toggles the Key Lock function between on and off with a long press for 5 seconds.
5. Power button
 - Turns the monitor on/off.

6. Power indicator

- The color definition of the power indicator is as the below table.

Status	Description
White	ON
Amber flashing	Entering standby mode
Amber	Standby mode/No signal
OFF	OFF
Red	G-SYNC
Green	HDR

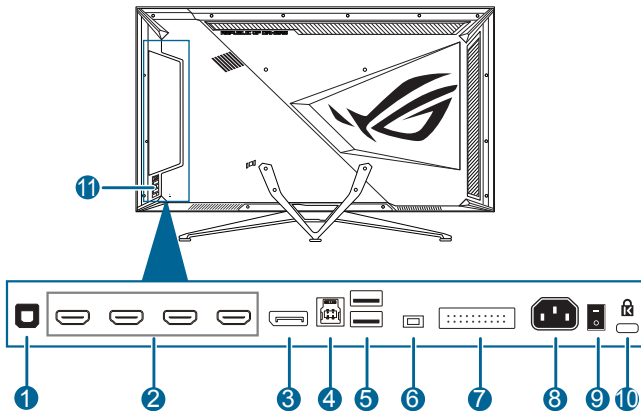

1.3.2 Back view

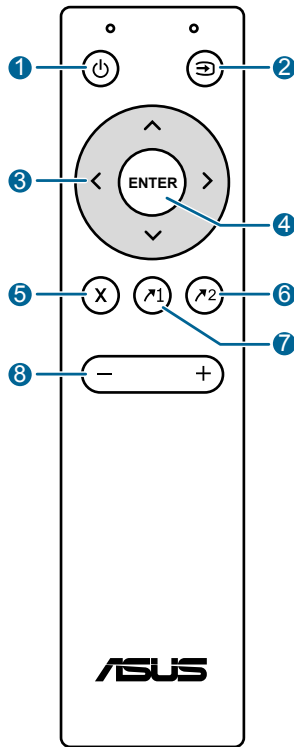

1. **S/PDIF output port.** This port is for outputting audio S/PDIF signal.
2. **HDMI ports.** These ports are for connection with an HDMI compatible device.
3. **DisplayPort.** This port is for connection for a DisplayPort compatible device.
4. **USB 3.0 upstream port.** This port is for connection with a USB upstream cable. The connection enables the USB ports on the monitor.
5. **USB 3.0 downstream ports.** These ports are for connection with USB devices, such as USB keyboard/mouse, USB flash drive, etc.
6. **For Aura Sync ROG logo projector only.**
7. **For service personnel only.**
8. **AC IN port.** This port connects the power cord.
9. **Power switch.** Press the switch to turn on/off power.
10. **Kensington lock slot.**
11. **Control buttons.**

1.3.3 Remote control



1.  Power button
 - Turns the monitor on/off.
2.  Input Select button:
 - Selects an available input source.



Press  button (Input Select button) to display DisplayPort, HDMI-1, HDMI-2, HDMI-3, HDMI-4 signals after you connect DisplayPort/HDMI cable with the monitor.

3. Directional arrow buttons
 - Turns on the OSD main menu.
 - Increases/Decreases values or moves your selection up/down/left/right.

4. ENTER button
 - Turns on the OSD main menu.
 - Enacts the selected OSD menu item.
5. X Exit button
 - Exits the OSD menu item.
 - Toggles the Key Lock function between on and off with a long press for 5 seconds.
6. ↗1 Shortcut button 1
 - Default: Brightness.
 - Turns on the OSD menu when the monitor enters standby mode.
 - To change the shortcut function, go to the System Setup > Shortcut on Remote menu.
7. ↗2 Shortcut button 2
 - Default: Brightness.
 - Turns on the OSD menu when the monitor enters standby mode.
 - To change the shortcut function, go to the System Setup > Shortcut on Remote menu.
8. Volume button
 - Decreases or increases the sound level.

1.3.4 Other Function(s)

G-SYNC Ultimate

The monitor supports HDR format. When detecting HDR content, an "HDR ON" message will pop up and display in the OSD menu.



-
- When displaying HDR content, the following function(s) are not available: GameVisual, Gamma, Dark Boost, "OFF" in the Variable Backlight, Auto SDR Brightness.
 - NVIDIA Pascal GPU Graphics Card like GTX1070, GTX1080 and GTX1080 Ti or higher is required.
-

2.1 Detaching the base (for VESA wall mount)

The detachable base of this monitor is specially designed for VESA wall mount.

To detach the base:

1. Have the front of the monitor face down on a table.
2. Use the hexagon key to loosen the four screws on the back of the monitor and remove the base.

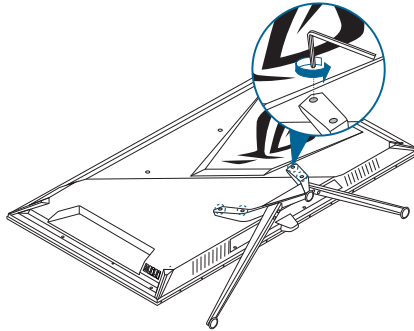

We recommend that you cover the table surface with soft cloth to prevent damage to the monitor.



- The VESA wall mount kit (400 x 400 mm) is purchased separately.
- Use only the UL Listed Wall Mount Bracket with minimum weight/load 40kg (Screw size: M6 x 10 mm)

2.2 Cable management

You can organize the cables with the help of the cable management hook.

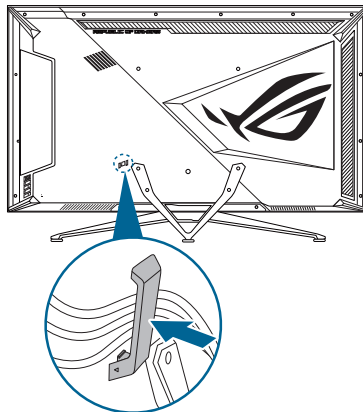

2.3 Installing the Aura Sync ROG logo projector

Screw the Aura Sync ROG logo projector to the back of the monitor and connect the other end to the mini-USB port of the monitor.

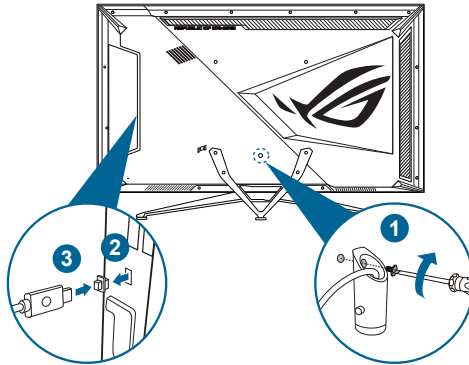

2.4 Connecting the cables

Connect the cables as the following instructions:

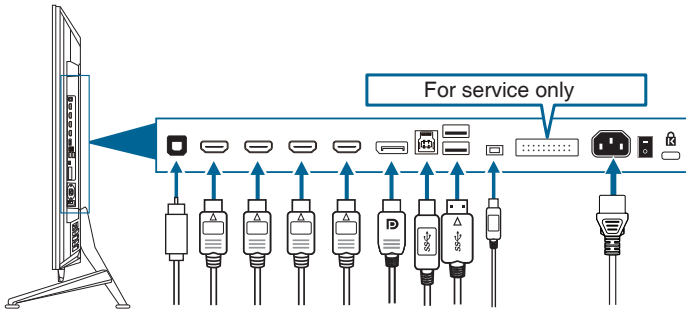

- **To connect the power cord:** Connect one end of the power cord securely to the monitor's AC input port, the other end to a power outlet.
- **To connect the DisplayPort/HDMI cable:**
 - a. Plug one end of the DisplayPort/HDMI cable to the monitor's DisplayPort/HDMI port.
 - b. Connect the other end of the DisplayPort/HDMI cable to your computer's DisplayPort/HDMI port.

- **To use the USB 3.0 ports:** Take an USB 3.0 cable, and plug the smaller end (type B) of the USB upstream cable to the monitor's USB upstream port, and the larger end (type A) to your computer's USB 3.0 port. Make sure your computer is installed with the latest Windows 7/Windows 8.1/Windows 10 operating system. That will enable the USB ports on the monitor to work.





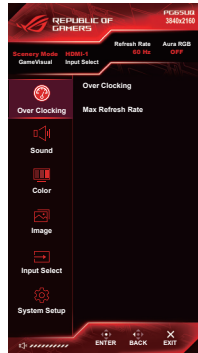

2.5 Turning on the monitor

Press the power button. See page 1-3 for the location of the power button. The power indicator lights up in white to show that the monitor is ON.

3.1 OSD (On-Screen Display) menu

3.1.1 How to reconfigure



1. Press the 5-way () button on the monitor or directional arrow buttons/ ENTER button on the remote control to activate the OSD menu.
2. Move the 5-way () button up/down/left/right or press the ^ / ~ / < / > button to navigate through the functions. Highlight the desired function and press the the 5-way () button or ENTER button to activate it. If the function selected has a sub-menu, move the 5-way () button up/down/left/right or press the ^ / ~ / < / > button again to navigate through the sub-menu functions. Highlight the desired sub-menu function and press the the 5-way () button or ENTER button to activate it.
3. Move the 5-way () button up/down/left/right or press the ^ / ~ / < / > button to change the settings of the selected function.
4. To exit and save the OSD menu, press the Exit button on the monitor or the **X** button on the remote control. To adjust other functions, repeat steps 1-3.

3.1.2 OSD function introduction

1. Over Clocking

This function allows you to adjust the refresh rate.

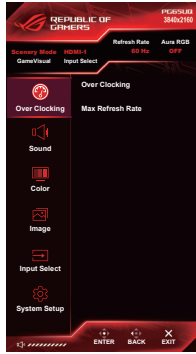

- **Max Refresh Rate:** Allows you to select a maximum refresh rate of 144Hz (Only for DisplayPort input). After selecting, press the () button twice to activate the setting.



- This function is only available when the color gamut is YUV422 with 10-bit color depth or below.
- After reboot, test the new Max Refresh Rate by enabling it in the NVIDIA Control Panel. If you don't see an image, disconnect the DP cable and use the monitor OSD to try again with a safer Max Refresh Rate.

2. Sound

In this function, you can adjust sound related settings.

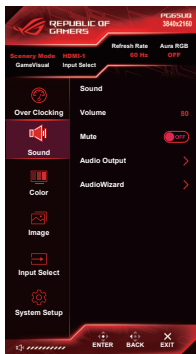

- **Volume:** The adjusting range is from 0 to 100.
- **Mute:** Toggles the monitor sound between on and off.

- **Audio Output:** Allows you to set the audio output path between Internal Speaker and SPDIF.



Once SPDIF is selected, Volume and AudioWizard are not available.

- **AudioWizard:** Contains 3 audio modes including Gaming Mode, Movie Mode and OFF Mode.

3. Color

You can set the color related setting from this menu.

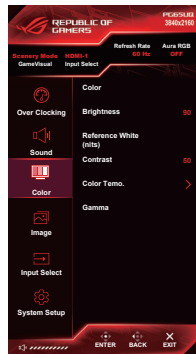

- **Brightness:** The adjusting range is from 0 to 100. When HDR is enabled, **Brightness** will be changed to **Peak White (nits) 1000** and cannot be adjusted.
- **Reference White (nits):** Displays the range only.
- **Contrast:** The adjusting range is from 0 to 100.
- **Color Temp.:** Contains 4 modes including Cool, Normal, Warm, and User Mode.
- **Gamma:** Allows you to set the color mode to 1.8, 2.0, 2.2, 2.4 or 2.6.

4. Image

You can set the image related setting from this menu.

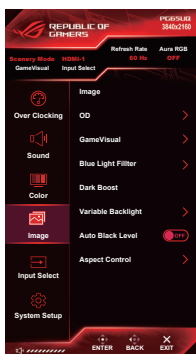

- **OD:** Improves the gray level response time of the LCD panel. It contains 3 modes including Extreme, Normal and OFF.
- **GameVisual:**
 - * **Scenery Mode:** This is the best choice for scenery photo displaying with GameVisual™ Video intelligence Technology.
 - * **Racing Mode:** This is the best choice for racing game playing with GameVisual™ Video intelligence Technology.
 - * **Cinema Mode:** This is the best choice for movie watching with GameVisual™ Video intelligence Technology.
 - * **RTS/RPG Mode:** This is the best choice for Real-Time Strategy (RTS)/Role-Playing Game (RPG) playing with GameVisual™ Video intelligence Technology.
 - * **FPS Mode:** This is the best choice for First Person Shooter game playing with GameVisual™ Video intelligence Technology.
 - * **sRGB Mode:** This is the best choice for viewing photos and graphics from PCs.



- In the sRGB mode, the following function(s) are not user-configurable: Color Temp., Brightness, Contrast, Gamma.
- In the Scenery and Cinema modes, the following function(s) are not user-configurable: Gamma, Dark Boost.

• **Blue Light Filter:**

- * **Level 0:** No change.
- * **Level 1~4:** The higher the level, the less blue light is scattered. When Blue Light Filter is activated, the default settings of Racing Mode will be automatically imported. Between Level 1 to Level 3, the Brightness function is user-configurable. Level 4 is optimized setting. It is compliance with TUV Low Blue Light Certification. The Brightness function is not user-configurable.



Please refer to the following to alleviate eye strains:

- Users should take some time away from the display if working for long hours. It is advised to take short breaks (at least 5 mins) after around 1 hour of continuous working at the computer. Taking short and frequent breaks is more effective than a single longer break.
- To minimize eye strain and dryness in your eyes, users should rest the eye periodically by focusing on objects that are far away.
- Eye exercises can help to reduce eye strain. Repeat these exercises often. If eye strain continues please consult a physician. Eye exercises: (1) Repeating look up and down (2) Slowly roll your eyes (3) Move your eyes diagonal.
- High energy blue light may lead to eye strain and AMD (Age-Related Macular Degeneration). Blue light Filter to reduce 70% (max.) harmful blue light to avoiding CVS (Computer Vision Syndrome).

- **Dark Boost:** Dark color enhancement adjusts monitor's gamma curve to enrich the dark tones in an image making dark scenes and objects much easier to see.
- **Variable Backlight:** Enables or disables operation with variable backlight. The options are Fast (preferably for gaming experiences), Medium and Gradual (preferably for business or word-processing situations).



A slight halo effect may be noticed on dark backgrounds when the function is enabled. This is normal and not a malfunction.

- **Auto Black Level:** Increases the black level according to the ambient brightness, making different shades of grey more visible to human eyes.
- **Aspect Control:** Adjusts the aspect ratio to Full, Aspect, or 1:1.

5. Input Select

In this function, you can select your desired input source and toggle the input auto switch function between on and off. When Input Auto Switch is enabled, the monitor will spend up to 2 minutes searching for available input source. If no input source is detected, disable this function and manually select one.

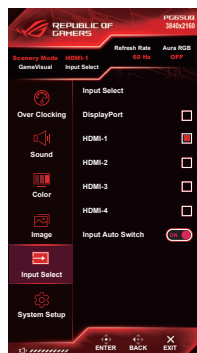

6. System Setup

Allows you to adjust the system.

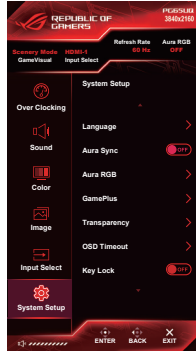

- **Language:** There are 9 languages for your selection, including English, French, Turkish, Simplified Chinese, Traditional Chinese, Japanese, Korean, Persian, Arabic.
- **Aura Sync:** Allows you to turn on or off the Aura Sync function that synchronizes the Aura RGB light effect among all supported devices.
- **Aura RGB:** In this function you can select an Aura RGB light effect for the monitor and change settings for the light effect. Select “OFF” if you want to turn the Aura RGB light effect off.



- If the Aura Sync function is turned ON, the Aura RGB function will become unavailable.
 - See 3.2 for information on how to customize Aura light effects from your computer.
-
- **GamePlus:** The GamePlus function provides a toolkit and creates a better gaming environment for users when playing different types of games. The crosshair overlay with different crosshair options lets you choose the one that best suits the game you’re playing. There’s also an onscreen timer you can position on the left of the display so you can keep track of the elapsed gaming time; while the FPS (frames per second) counter lets you know how smooth the game is running.

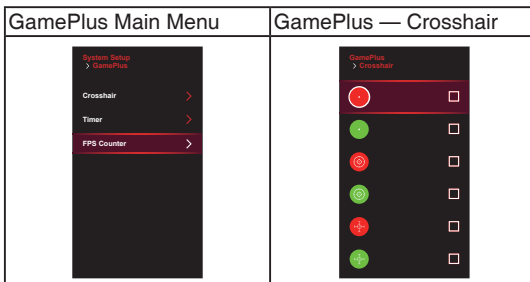

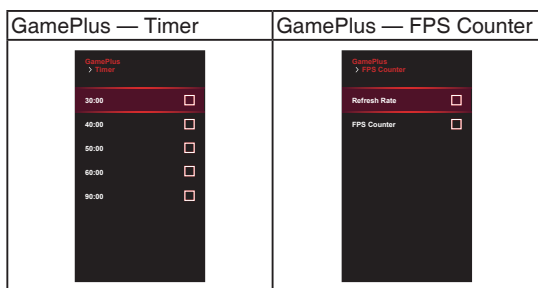

- **Transparency:** Adjusts the OSD background from opaque to transparent.
- **OSD Timeout:** Adjusts the OSD timeout from 10 to 120 seconds.
- **Key Lock:** To disable all function keys. Press **X** over 5 seconds to cancel the key lock function.
- **Information:** Shows the monitor information.
- **DisplayPort Deep Sleep:** Puts the DisplayPort port into deep sleep.
- **HDMI Deep Sleep:** Puts the HDMI port into deep sleep.



If the monitor cannot wake up after going into deep sleep, do one of the followings:

- Press any button (except the power button) on the monitor to wake it up.
- Disable the Deep Sleep function. (Recommended)

- **ECO Mode:** Reduces power consumption.



ECO mode minimizes power consumption at the expense of image quality. Turn it off for best image quality (Recommended).

- **Auto SDR Brightness:** Synchronizes display brightness with ambient light changes.



Since HDR10 is an absolute standard, where the content defines the absolute nits level, we do not discourage use of Auto SDR Brightness in HDR mode.

- **Display SDR Input:** “sRGB” is recommended when using Microsoft based systems. “Wide Gamut” is recommended when using Mac OS systems.
- **Warning Message (HDR):** Allows you to turn on or off the warning message under HDR Mode.
- **DP SDR YCbCr sRGB Gamma:** “ON” is sRGB gamma curve and “OFF” is BT.1886 gamma curve.

- **HDMI SDR YCbCr sRGB Gamma:** “ON” is sRGB gamma curve and “OFF” is BT.1886 gamma curve and matches movie studio mastering displays.
- **Shortcut on Remote:** Defines the functions for Shortcut 1 and 2 buttons on the remote control. When a certain function is selected or activated, your shortcut key may not support. Available function choices for shortcut: Brightness, Contrast, Volume, Input Select, GamePlus, GameVisual.
- **All Reset:** “Yes” allows you to restore the default settings.

3.2 ASUS Aura

AURA is a software program that controls the colorful LEDs on supported devices, such as monitors, motherboards, graphic cards, desktop PCs, etc. Aura allows you to adjust the color of the RGB LEDs on these devices and select different light effects. You can also correct or adjust the color of the LEDs by calibrating them.

To activate Aura:

1. Turn ON the **Aura Sync** function in the OSD menu.
2. Connect the USB 3.0 upstream port of the monitor to the USB port of your computer.
3. Install AURA and then restart the computer.
4. Double-click the AURA program icon  on your desktop.

Refer to the figure below for information about the AURA program functions.

Adjust AURA lighting options

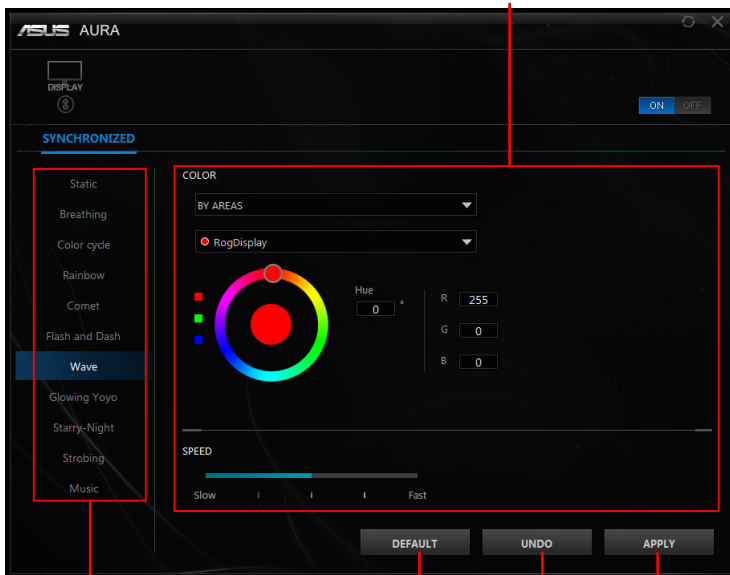

Select the desired AURA lighting effect when the system has been turned on

Click to enable the default settings

Click to apply the changes

Click to undo the changes



- If the USB upstream connection between the monitor and computer is disconnected, to resume the Aura function, you need to re-connect the USB 3.0 upstream port of the monitor to the computer and then restart the computer.
- Visit <https://www.asus.com/campaign/aura> for more details.

3.3 Specifications summary

Panel Type	TFT LCD
Panel size	65"W (16:9, 64.53") wide screen
Max. Resolution	3840 x 2160
Pixel pitch	372 x 372 mm
Brightness (Typ.)	1000 cd/m ² (Peak/HDR on)
Contrast Ratio (Typ.)	4000:1
Viewing angle(H/V) CR>10	178°/178°
Display colors	16.7 M
Response time	4 ms (Gray to Gray)
Color temperature selection	4 color temperatures
Analog input	No
Digital input	DisplayPort v1.4 x 1, HDMI v2.0 x 4
SPDIF output	Yes
Audio input	No
Speaker (Built-in)	Yes
USB 3.0 port	Upstream x 1, Downstream x 2
Colors	Black
Power LED	White (On)/Amber (Standby)/Red (G-Sync)/Green (HDR)
Tilt	No
Swivel	No
Height adjustment	No
VESA wall mount	400 x 400 mm
Kensington lock	Yes
Voltage rating	AC: 8.0 A, 100~240V
Power consumption	Power On: < 700 W (2s), Standby: < 0.5 W, Power Off: < 0.5 W
Temperature (Operating)	0°C~40°C
Temperature (Non-operating)	-20°C~+60°C
Dimensions (W x H x D)	1448.08 mm x 946.9 mm x 389.82 mm (with stand) 1448.08 mm x 863.83 mm x 87.2 mm (without stand) 1630 mm x 1104 mm x 507 mm (package)
Weight (Esti.)	36.8 kg (Net); 57.5 kg (Gross)
Multi-languages	9 languages (English, French, Turkish, Simplified Chinese, Traditional Chinese, Japanese, Korean, Persian, Arabic)

Accessories	Quick start guide, warranty card, remote control, power cord, DP cable, HDMI cable, USB cable, Aura Sync ROG logo projector, cable management hook, hexagon key, calibration report
Compliance and Standards	UL/cUL, CB, CE, ErP, FCC, CCC, BSMI, CU, C-Tick, VCCI, PSE, CEL Level 3, J-MOSS, RoHS, WEEE, Windows 7 & 8.1 & 10 WHQL, KCC, E-STANDBY, TUV-Flicker Free, TUV Low Blue Light, UkrSEPRO, RCM, MEPS

***Specifications are subject to change without notice.**

3.4 Outline dimensions

ASUS PG65UQ Outline Dimension
 *Unit:mm(Inch)

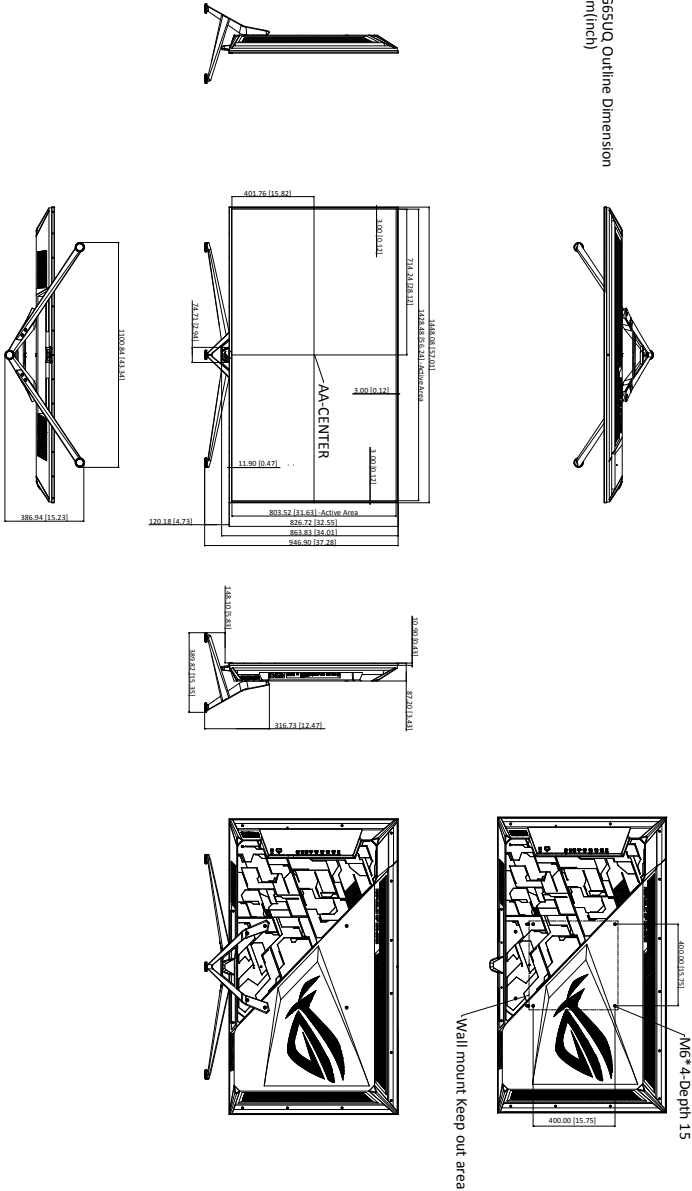

3.5 Troubleshooting (FAQ)

Problem	Possible Solution
Power LED is not ON	<ul style="list-style-type: none">• Press the power button to check if the monitor is in the ON mode.• Check if the power cord is properly connected to the monitor and the power outlet.
The power LED lights white and there is no screen image	<ul style="list-style-type: none">• Check if the monitor and the computer are in the ON mode.• Make sure the signal cable is properly connected the monitor and the computer.• Inspect the signal cable and make sure none of the pins are bent.• Connect the computer with another available monitor to check if the computer is properly working.
Screen image is too light or dark	<ul style="list-style-type: none">• Adjust the Contrast and Brightness settings via OSD.
Screen image bounces or a wave pattern is present in the image	<ul style="list-style-type: none">• Make sure the signal cable is properly connected to the monitor and the computer.• Move electrical devices that may cause electrical interference.
Screen image has color defects (white does not look white)	<ul style="list-style-type: none">• Inspect the signal cable and make sure that none of the pins are bent.• Perform All Reset via OSD.• Adjust the R/G/B color settings or select the Color Temperature via OSD.
HDR content is not played properly	<ul style="list-style-type: none">• Make sure the input source supports HDR playback (with proper system settings and latest software).• Make sure the content is HDR encoded.
A corrupted half-size image is displayed when playing 4K HDR content.	<ul style="list-style-type: none">• Check the chroma settings in the image source for correct HDR operation. Manually adjust the related settings. Contact the device manufacturer if the problem persists.

3.6 Supported operating mode

HDMI input

Resolution Frequency	Refresh Rate
640 x 480	60Hz
800 x 600	60Hz
1024 x 768	60Hz
1280 x 720	60Hz
1920 x 1080	60Hz
3840 x 2160	60Hz

Note:

Do not support interlace and color gamut YUV420.

When connecting to XBOX via the HDMI port, 1080p@120Hz and 1440p@60Hz can be supported.

DisplayPort input

Resolution Frequency	Refresh Rate
640 x 480	60Hz
800 x 600	60Hz
1024 x 768	60Hz
3840 x 2160	24Hz
3840 x 2160	30Hz
3840 x 2160	60Hz
3840 x 2160	82Hz
3840 x 2160	98Hz
3840 x 2160	120Hz

Note:

Do not support interlace.

G-SYNC (only for DisplayPort input) supported NVIDIA GPUs: NVIDIA Pascal GPU Graphics Card like GTX1070, GTX1080 and GTX1080 Ti or higher. For other GPUs, please contact the manufactures to see if they are compatible.

DisplayPort input--Over clocking

Resolution Frequency	Refresh Rate
3840 x 2160	144Hz

Note:

Do not support interlace.

Since HDR content is aimed at 4K (3840 x 2160) resolution, other resolution may result in abnormal images.

Please wait for Over Clocking function to initiate. The process may take less than 40 seconds.

Over Clocking supported GPUs: NVIDIA Pascal GPU Graphics Card like GTX1070, GTX1080 and GTX1080 Ti or higher. For other GPUs, please contact the manufactures to see if they are compatible.

The monitor is purposely supporting the NVIDIA G-SYNC technology and targeting NVIDIA graphics solutions.



Please note that Over Clocking function/performance depends on the GPUs, contents displayed, viewing distance/angle, refresh rate and user eyes sensitivity. ASUS only provides this function. The performance or any side effect after activation is not guaranteed. Side effect, such as decayed contrast ratio or waterfall is not a product defect but trade off.

ASUS

CE FC



<http://ROG.ASUS.com>