

ASRock®



X570
PHANTOM
GAMING-ITX/TB3

User Manual

Version 1.0

Published June 2019

Copyright©2019 ASRock INC. All rights reserved.

Copyright Notice:

No part of this documentation may be reproduced, transcribed, transmitted, or translated in any language, in any form or by any means, except duplication of documentation by the purchaser for backup purpose, without written consent of ASRock Inc.

Products and corporate names appearing in this documentation may or may not be registered trademarks or copyrights of their respective companies, and are used only for identification or explanation and to the owners' benefit, without intent to infringe.

Disclaimer:

Specifications and information contained in this documentation are furnished for informational use only and subject to change without notice, and should not be constructed as a commitment by ASRock. ASRock assumes no responsibility for any errors or omissions that may appear in this documentation.

With respect to the contents of this documentation, ASRock does not provide warranty of any kind, either expressed or implied, including but not limited to the implied warranties or conditions of merchantability or fitness for a particular purpose.

In no event shall ASRock, its directors, officers, employees, or agents be liable for any indirect, special, incidental, or consequential damages (including damages for loss of profits, loss of business, loss of data, interruption of business and the like), even if ASRock has been advised of the possibility of such damages arising from any defect or error in the documentation or product.



This device complies with Part 15 of the FCC Rules. Operation is subject to the following two conditions:

- (1) this device may not cause harmful interference, and
- (2) this device must accept any interference received, including interference that may cause undesired operation.

CALIFORNIA, USA ONLY

The Lithium battery adopted on this motherboard contains Perchlorate, a toxic substance controlled in Perchlorate Best Management Practices (BMP) regulations passed by the California Legislature. When you discard the Lithium battery in California, USA, please follow the related regulations in advance.

“Perchlorate Material-special handling may apply, see www.dtsc.ca.gov/hazardouswaste/perchlorate”

ASRock Website: <http://www.asrock.com>

AUSTRALIA ONLY

Our goods come with guarantees that cannot be excluded under the Australian Consumer Law. You are entitled to a replacement or refund for a major failure and compensation for any other reasonably foreseeable loss or damage caused by our goods. You are also entitled to have the goods repaired or replaced if the goods fail to be of acceptable quality and the failure does not amount to a major failure. If you require assistance please call ASRock Tel : +886-2-28965588 ext.123 (Standard International call charges apply)

The terms HDMI® and HDMI High-Definition Multimedia Interface, and the HDMI logo are trademarks or registered trademarks of HDMI Licensing LLC in the United States and other countries.



CE Warning

This device complies with directive 2014/53/EU issued by the Commission of the European Community.

This equipment complies with EU radiation exposure limits set forth for an uncontrolled environment.

This equipment should be installed and operated with minimum distance 20cm between the radiator & your body.

Operations in the 5.15-5.35GHz band are restricted to indoor usage only.

	AT	BE	BG	CH	CY	CZ	DE
	DK	EE	EL	ES	FI	FR	HR
	HU	IE	IS	IT	LI	LT	LU
	LV	MT	NL	NO	PL	PT	RO
	SE	SI	SK	TR	UK		



Radio transmit power per transceiver type

Function	Frequency	Maximum Output Power (EIRP)
WiFi	2400-2483.5 MHz	18.5 + / -1.5 dbm
	5150-5250 MHz	21.5 + / -1.5 dbm
	5250-5350 MHz	18.5 + / -1.5 dbm (no TPC) 21.5 + / -1.5 dbm (TPC)
	5470-5725 MHz	25.5 + / -1.5 dbm (no TPC) 28.5 + / -1.5 dbm (TPC)
Bluetooth	2400-2483.5 MHz	8.5 + / -1.5 dbm

Contents

Chapter 1 Introduction	1
1.1 Package Contents	1
1.2 Specifications	2
1.3 Motherboard Layout	7
1.4 I/O Panel	10
Chapter 2 Installation	14
2.1 Installing the CPU	15
2.2 Installing the CPU Fan and Heatsink	17
2.3 Installing Memory Modules (DIMM)	19
2.4 Expansion Slots (PCI Express Slots)	22
2.5 Onboard Headers and Connectors	23
2.6 Smart Switches	28
2.7 M.2_SSD (NGFF) Module Installation Guide	29
Chapter 3 Software and Utilities Operation	31
3.1 Installing Drivers	31
3.2.1 Installing Phantom Gaming Tuning	32
3.2.2 Using Phantom Gaming Tuning	32
3.3 ASRock Live Update & APP Shop	35
3.3.1 UI Overview	35
3.3.2 Apps	36

3.3.3	BIOS & Drivers	39
3.3.4	Setting	40
3.4	Creative SoundBlaster Cinema5	41
3.5	ASRock Polychrome SYNC	42
Chapter 4 UEFI SETUP UTILITY		45
4.1	Introduction	45
4.1.1	UEFI Menu Bar	45
4.1.2	Navigation Keys	46
4.2	Main Screen	47
4.3	OC Tweaker Screen	48
4.4	Advanced Screen	52
4.4.1	CPU Configuration	53
4.4.2	Onboard Devices Configuration	54
4.4.3	Storage Configuration	56
4.4.4	ACPI Configuration	57
4.4.5	Trusted Computing	58
4.4.6	AMD CBS	59
4.4.7	AMD PBS	60
4.4.8	AMD Overclocking	61
4.5	Tools	62
4.6	Hardware Health Event Monitoring Screen	63
4.7	Security Screen	65
4.8	Boot Screen	66
4.9	Exit Screen	68

Chapter 1 Introduction

Thank you for purchasing ASRock X570 Phantom Gaming-ITX/TB3 motherboard, a reliable motherboard produced under ASRock's consistently stringent quality control. It delivers excellent performance with robust design conforming to ASRock's commitment to quality and endurance.

In this documentation, Chapter 1 and 2 contains the introduction of the motherboard and step-by-step installation guides. Chapter 3 contains the operation guide of the software and utilities. Chapter 4 contains the configuration guide of the BIOS setup.



Because the motherboard specifications and the BIOS software might be updated, the content of this documentation will be subject to change without notice. In case any modifications of this documentation occur, the updated version will be available on ASRock's website without further notice. If you require technical support related to this motherboard, please visit our website for specific information about the model you are using. You may find the latest VGA cards and CPU support list on ASRock's website as well. ASRock website <http://www.asrock.com>.

1.1 Package Contents

- ASRock X570 Phantom Gaming-ITX/TB3 Motherboard (Mini-ITX Form Factor)
- ASRock X570 Phantom Gaming-ITX/TB3 Quick Installation Guide
- ASRock X570 Phantom Gaming-ITX/TB3 Support CD
- 2 x Serial ATA (SATA) Data Cables (Optional)
- 1 x ASRock WiFi 2.4/5 GHz Antenna (Optional)
- 1 x Screw for M.2 Socket (Optional)

1.2 Specifications

- Platform**
- Mini-ITX Form Factor
 - 2oz Copper PCB

- CPU**
- Supports AMD AM4 socket Ryzen™ 2000 and 3000 series processors
 - Digi Power design
 - 10 Power Phase design

- Chipset**
- AMD X570

- Memory**
- Dual Channel DDR4 Memory Technology
 - 2 x DDR4 DIMM Slots
 - AMD Ryzen series CPUs (Matisse) support DDR4 4533+(OC)/4400(OC)/4300(OC)/4266(OC)/4200(OC)/4133(OC)/3466(OC)/3200/2933/2667/2400/2133 ECC & non-ECC, un-buffered memory*
 - AMD Ryzen series CPUs (Pinnacle Ridge) support DDR4 3600+(OC)/3466(OC)/3200(OC)/2933/2667/2400/2133 ECC & non-ECC, un-buffered memory*
 - AMD Ryzen series CPUs (Picasso) support DDR4 3466+(OC)/3200(OC)/2933/2667/2400/2133 non-ECC, un-buffered memory*

* For Ryzen Series CPUs (Picasso), ECC is only supported with PRO CPUs.

* Please refer to Memory Support List on ASRock's website for more information. (<http://www.asrock.com/>)

* Please refer to page 19 for DDR4 UDIMM maximum frequency support.

- Max. capacity of system memory: 32GB
- 15μ Gold Contact in DIMM Slots

Expansion Slot **AMD Ryzen series CPUs (Matisse)**

- 1 x PCI Express 4.0 x16 Slot (PCIe1: x16 mode)*

AMD Ryzen series CPUs (Pinnacle Ridge)

- 1 x PCI Express 3.0 x16 Slot (PCIe1: x16 mode)*

AMD Ryzen series CPUs (Picasso)

- 1 x PCI Express 3.0 x16 Slot (PCIe1: x8 mode)*

* Supports PCIe riser cards to extend one x16 slot to two x8 slots if you install AMD Ryzen series CPUs

* Supports NVMe SSD as boot disks

- 1 x Vertical M.2 Socket (Key E) with the bundled WiFi-802.11ax module (on the rear I/O)
- 15µ Gold Contact in VGA PCIe Slot (PCIe1)

Graphics

- Integrated AMD Radeon™ Vega Series Graphics in Ryzen Series APU*

* Actual support may vary by CPU

- DirectX 12, Pixel Shader 5.0
- Shared memory default 2GB. Max Shared memory supports up to 16GB.

* The Max shared memory 16GB requires 32GB system memory installed.

- Supports HDMI 2.0 with max. resolution up to 4K x 2K (4096x2160) @ 60Hz
- Supports DisplayPort 1.4 Input with max. resolution up to 4K x 2K (4096x2160) @ 60Hz

* DisplayPort 1.4 Input is used to connect a Type-C Monitor.

- Supports Auto Lip Sync, Deep Color (12bpc), xvYCC and HBR (High Bit Rate Audio) with HDMI 2.0 Port (Compliant HDMI monitor is required)
- Supports HDR (High Dynamic Range) with HDMI 2.0
- Supports HDCP 2.2 with HDMI 2.0 and DisplayPort 1.4 Ports
- Supports 4K Ultra HD (UHD) playback with HDMI 2.0 and DisplayPort 1.4 Ports

Audio

- 7.1 CH HD Audio with Content Protection (Realtek ALC1220 Audio Codec)
- Premium Blu-ray Audio support
- Supports Surge Protection
- Nichicon Fine Gold Series Audio Caps
- Pure Power-In
- Direct Drive Technology
- PCB Isolate Shielding

- Impedance Sensing on Rear Out port
- Individual PCB Layers for R/L Audio Channel
- Gold Audio Jacks
- 15 μ Gold Audio Connector
- Supports Creative SoundBlaster Cinema5

LAN

- Gigabit LAN 10/100/1000 Mb/s
- GigaLAN Intel® I211AT
- Supports Wake-On-LAN
- Supports Lightning/ESD Protection
- Supports Energy Efficient Ethernet 802.3az
- Supports PXE

Wireless LAN

- Intel® 802.11ax WiFi Module
- Supports IEEE 802.11a/b/g/n/ax
- Supports Dual-Band (2.4/5 GHz)
- Supports WiFi6 802.11ax (2.4Gbps)
- 2 antennas to support 2 (Transmit) x 2 (Receive) diversity technology
- Supports Bluetooth 5.0 + High speed class II
- Supports MU-MIMO

Rear Panel I/O

- 2 x Antenna Ports (on I/O Panel Shield)
- 1 x PS/2 Mouse/Keyboard Port
- 1 x HDMI Port
- 1 x DisplayPort 1.4 Input
- 1 x Optical SPDIF Out Port
- 1 x USB 3.2 Gen2 Type-C Port (Supports ESD Protection)
- 2 x USB 3.2 Gen2 Type-A Ports (Supports ESD Protection)
- 2 x USB 3.2 Gen1 Ports (Supports ESD Protection)
- 1 x RJ-45 LAN Port with LED (ACT/LINK LED and SPEED LED)
- 1 x Clear CMOS Button
- HD Audio Jacks: Rear Speaker / Central / Bass / Line in / Front Speaker / Microphone (Gold Audio Jacks)

Storage

- 4 x SATA3 6.0 Gb/s Connectors, support RAID (RAID 0, RAID 1 and RAID 10), NCQ, AHCI and Hot Plug
 - 1 x Hyper M.2 Socket, supports M Key type 2280 M.2 PCI Express module up to Gen4x4 (64 Gb/s) (with Matisse)
 - or Gen3x4 (32 Gb/s) (with Pinnacle Ridge and Picasso)*
- * Supports NVMe SSD as boot disks

Connector

- 1 x SPI TPM Header
 - 1 x RGB LED Header
- * Supports in total up to 12V/3A, 36W LED Strip
- 1 x Addressable LED Header
- * Supports in total up to 5V/3A, 15W LED Strip
- 1 x CPU Fan Connector (4-pin)
- * The CPU Fan Connector supports the CPU fan of maximum 1A (12W) fan power.
- 1 x CPU/Water Pump Fan Connector (4-pin) (Smart Fan Speed Control)
- * The CPU/Water Pump Fan supports the water cooler fan of maximum 2A (24W) fan power.
- 1 x Chassis/Water Pump Fan Connector (4-pin) (Smart Fan Speed Control)
- * The Chassis/Water Pump Fan supports the water cooler fan of maximum 2A (24W) fan power.
- * CPU_FAN1/WP, CPU_FAN2/WP and CHA_FAN1/WP can auto detect if 3-pin or 4-pin fan is in use.
- 1 x 24 pin ATX Power Connector (Hi-Density Power Connector)
 - 1 x 8 pin 12V Power Connector (Hi-Density Power Connector)
 - 1 x Front Panel Audio Connector (15μ Gold Audio Connector)
 - 1 x USB 2.0 Header (Supports 2 USB 2.0 ports) (Supports ESD Protection)
 - 1 x USB 3.2 Gen1 Header (Supports 2 USB 3.2 Gen1 ports) (Supports ESD Protection)

**BIOS
Feature**

- AMI UEFI Legal BIOS with GUI support
- Supports “Plug and Play”
- ACPI 5.1 compliance wake up events
- Supports jumperfree
- SMBIOS 2.3 support
- CPU, CPU VDDCR_SOC, DRAM, VPPM, PREM VDD_CLDO, PERM VDDCR_SOC, +1.8V, VDDP Voltage Multi-adjustment

**Hardware
Monitor**

- Temperature Sensing: CPU/Water Pump, Chassis/Water Pump Fans
- Fan Tachometer: CPU/Water Pump, Chassis/Water Pump Fans
- Quiet Fan (Auto adjust chassis fan speed by CPU temperature): CPU/Water Pump, Chassis/Water Pump Fans
- Fan Multi-Speed Control: CPU/Water Pump, Chassis/Water Pump Fans
- Voltage monitoring: +12V, +5V, +3.3V, CPU Vcore, CPU VD-DCR_SOC, DRAM, VPPM, PREM VDDCR_SOC, +1.8V, VDDP

OS

- Microsoft® Windows® 10 64-bit

**Certifica-
tions**

- FCC, CE
- ErP/EuP ready (ErP/EuP ready power supply is required)

* For detailed product information, please visit our website: <http://www.asrock.com>



Please realize that there is a certain risk involved with overclocking, including adjusting the setting in the BIOS, applying Untied Overclocking Technology, or using third-party overclocking tools. Overclocking may affect your system's stability, or even cause damage to the components and devices of your system. It should be done at your own risk and expense. We are not responsible for possible damage caused by overclocking.

1.3 Motherboard Layout

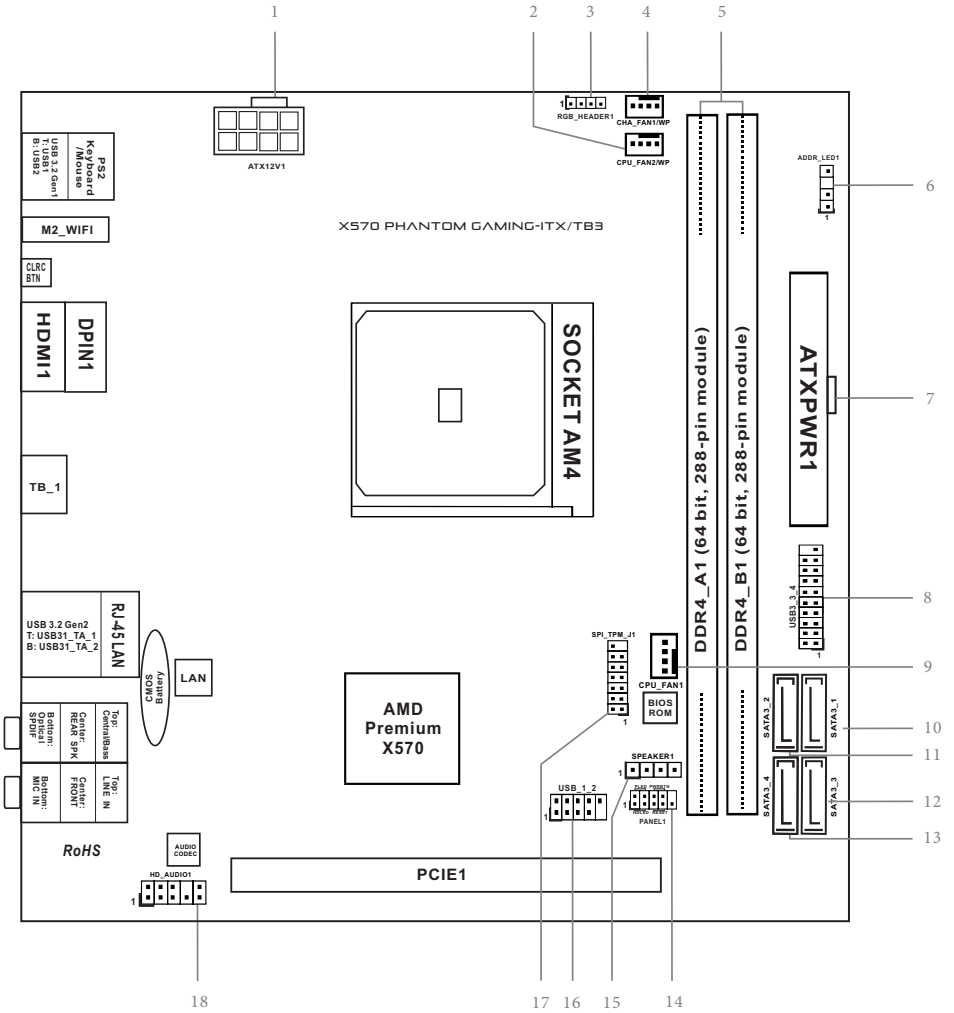

Back Side View

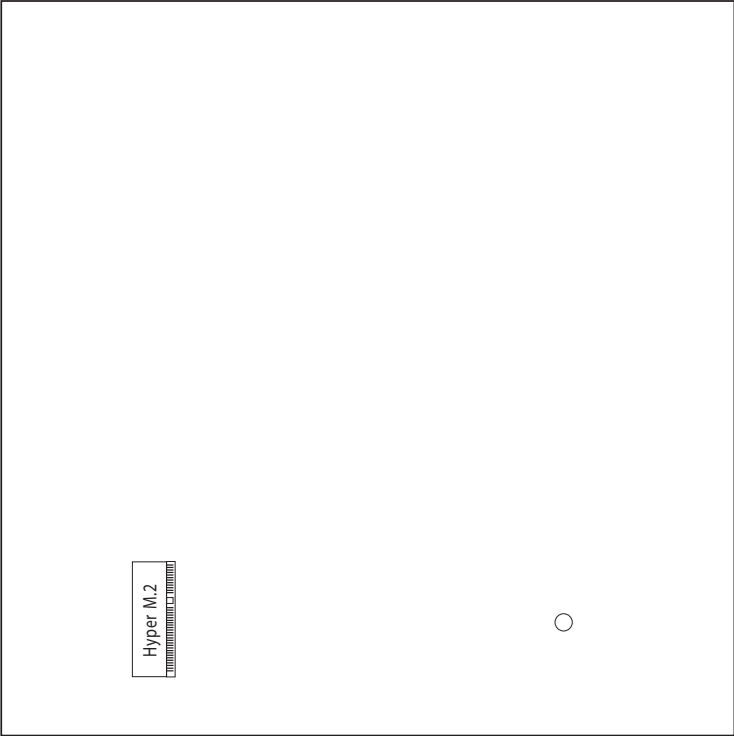

No.	Description
1	ATX 12V Power Connector (ATX12V1)
2	CPU / Waterpump Fan Connector (CPU_FAN2/WP)
3	RGB LED Header (RGB_HEADER1)
4	Chassis / Waterpump Fan Connector(CHA_FAN1/WP)
5	2 x 288-pin DDR4 DIMM Slots (DDR4_A1, DDR4_B1)
6	Addressable LED Header (ADDR_LED1)
7	ATX Power Connector (ATXPWR1)
8	USB 3.2 Gen1 Header (USB3_3_4)
9	CPU Fan Connector (CPU_FAN1)
10	SATA3 Connector (SATA3_1)
11	SATA3 Connector (SATA3_2)
12	SATA3 Connector (SATA3_3)
13	SATA3 Connector (SATA3_4)
14	System Panel Header (PANEL1)
15	Chassis Speaker Header (SPEAKER1)
16	USB 2.0 Header (USB_1_2)
17	SPI TPM Header (SPI_TPM_J1)
18	Front Panel Audio Header (HD_AUDIO1)

1.4 I/O Panel

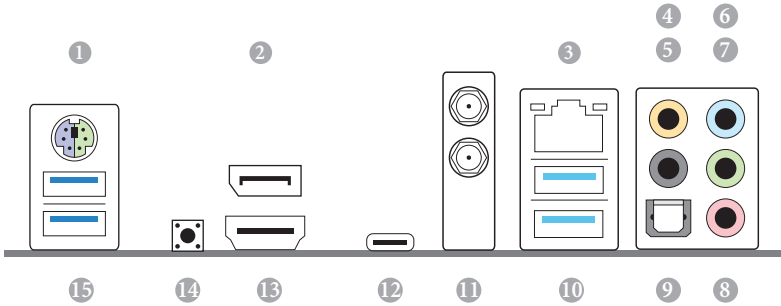

No.	Description	No.	Description
1	PS/2 Mouse/Keyboard Port	9	Optical SPDIF Out Port
2	DisplayPort 1.4 Input	10	USB 3.2 Gen2 Ports (USB31_TA_12)
3	LAN RJ-45 Port*	11	Antenna Ports (on I/O Panel Shield)
4	Central / Bass (Orange)	12	USB 3.2 Gen2 Type-C Port***
5	Rear Speaker (Black)	13	HDMI Port
6	Line In (Light Blue)	14	Clear CMOS Button
7	Front Speaker (Lime)**	15	USB 3.2 Gen1 Ports (USB3_12)
8	Microphone (Pink)		

*There are two LEDs on each LAN port. Please refer to the table below for the LAN port LED indications.

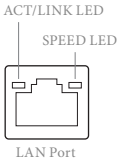

Activity / Link LED		Speed LED	
Status	Description	Status	Description
Off	No Link	Off	10Mbps connection
Blinking	Data Activity	Orange	100Mbps connection
On	Link	Green	1Gbps connection

** If you use a 2-channel speaker, please connect the speaker's plug into "Front Speaker Jack". See the table below for connection details in accordance with the type of speaker you use.

Audio Output Channels	Front Speaker (No. 7)	Rear Speaker (No. 5)	Central / Bass (No. 4)	Line In (No. 6)
2	V	--	--	--
4	V	V	--	--
6	V	V	V	--
8	V	V	V	V

***For the further information, please visit www.asrock.com.

1.5 WiFi-802.11ax Module and ASRock WiFi 2.4/5 GHz Antenna

WiFi-802.11ax + BT Module

This motherboard comes with an exclusive WiFi 802.11 a/b/g/n/ax + BT v5.0 module (pre-installed on the rear I/O panel) that offers support for WiFi 802.11 a/b/g/n/ax connectivity standards and Bluetooth v5.0. WiFi + BT module is an easy-to-use wireless local area network (WLAN) adapter to support WiFi + BT. Bluetooth v5.0 standard features Smart Ready technology that adds a whole new class of functionality into the mobile devices. BT 5.0 also includes Low Energy Technology and ensures extraordinary low power consumption for PCs. The 2T2R WiFi solution sets a WiFi high speed standard and offers max link rate up to 2.4Gbps.

* The transmission speed may vary according to the environment.



ASRock WiFi 2.4/5 GHz Antenna

WiFi Antenna Installation Guide

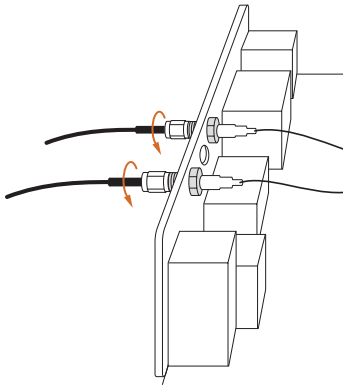

Step 1

Connect the WiFi 2.4/5 GHz Antenna to the antenna connectors. Turn the antenna clockwise until it is securely connected.

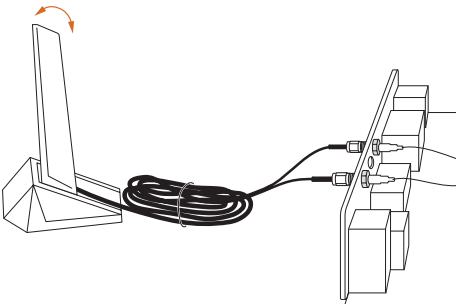

Step 2

Set the WiFi 2.4/5 GHz Antenna at 90-degree angle.

*You may need to adjust the direction of the antenna for a stronger signal.

Chapter 2 Installation

This is a Mini-ITX form factor motherboard. Before you install the motherboard, study the configuration of your chassis to ensure that the motherboard fits into it.

Pre-installation Precautions

Take note of the following precautions before you install motherboard components or change any motherboard settings.

- Make sure to unplug the power cord before installing or removing the motherboard. Failure to do so may cause physical injuries to you and damages to motherboard components.
- In order to avoid damage from static electricity to the motherboard's components, NEVER place your motherboard directly on a carpet. Also remember to use a grounded wrist strap or touch a safety grounded object before you handle the components.
- Hold components by the edges and do not touch the ICs.
- Whenever you uninstall any components, place them on a grounded anti-static pad or in the bag that comes with the components.
- When placing screws to secure the motherboard to the chassis, please do not over-tighten the screws! Doing so may damage the motherboard.

2.1 Installing the CPU



Unplug all power cables before installing the CPU.

1

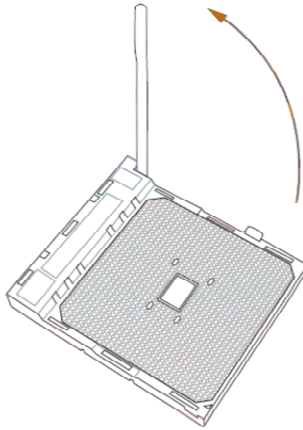

2

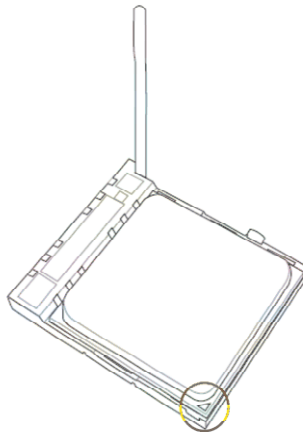

3

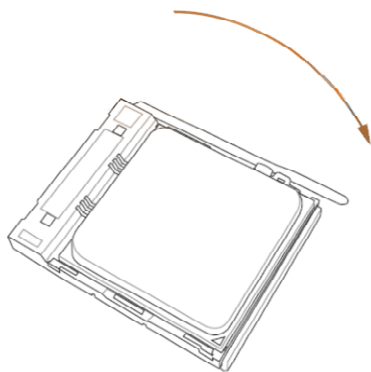

2.2 Installing the CPU Fan and Heatsink

After you install the CPU into this motherboard, it is necessary to install a larger heatsink and cooling fan to dissipate heat. You also need to spray thermal grease between the CPU and the heatsink to improve heat dissipation. Make sure that the CPU and the heatsink are securely fastened and in good contact with each other.



Please turn off the power or remove the power cord before changing a CPU or heatsink.

***Please note that the AMD coolers are not compatible with this motherboard.**

Please visit www.asrock.com for the CPU coolers compatibility list.

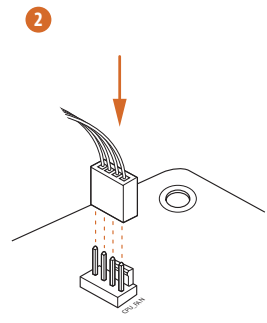
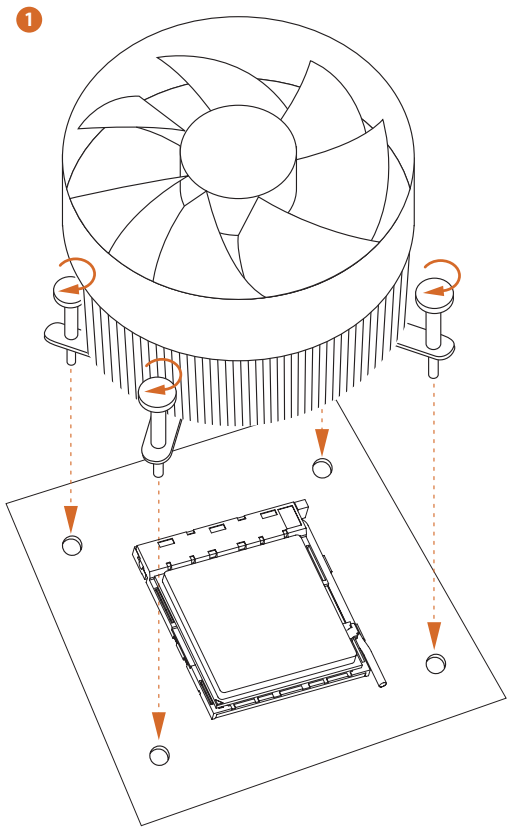
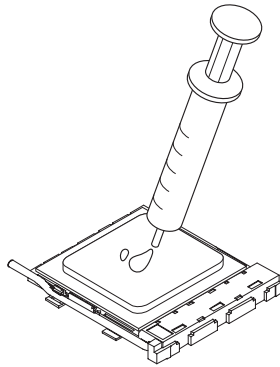

*The diagrams shown here are for reference only. The headers might be in a different position on your motherboard.

2.3 Installing Memory Modules (DIMM)

This motherboard provides two 288-pin DDR4 (Double Data Rate 4) DIMM slots, and supports Dual Channel Memory Technology.



1. For dual channel configuration, you always need to install identical (the same brand, speed, size and chip-type) DDR4 DIMM pairs.
2. It is unable to activate Dual Channel Memory Technology with only one memory module installed.
3. It is not allowed to install a DDR, DDR2 or DDR3 memory module into a DDR4 slot; otherwise, this motherboard and DIMM may be damaged.

AMD non-XMP Memory Frequency Support

Ryzen Series CPUs (Matisse):

UDIMM Memory Slot		
# of DIMMs on the Channel	# of Ranks per DIMM	1.20V
1 of 1	xR	3200
1 of 2	xR-0	2933-3200
2 of 2	1R-1R	2667
2 of 2	2R-xR	2400-2667

Ryzen Series CPUs (Pinnacle Ridge):

UDIMM Memory Slot		Frequency (Mhz)
A1	B1	
SR	-	2933
-	SR	2933
DR	-	2933
-	DR	2933
SR	SR	2933
DR	DR	2933

Ryzen Series CPUs (Picasso):

UDIMM Memory Slot		
# of DIMMs on the Channel	# of Ranks per DIMM	1.20V
1 of 1	xR	SR: 2933 DR: 2677
1 of 2	xR-0	SR: 2667 DR: 2400
2 of 2	1R-1R	2133
2 of 2	2R-xR	1866

x=1 or 2

SR: Single rank DIMM, 1Rx4 or 1Rx8 on DIMM module label

DR: Dual rank DIMM, 2Rx4 or 2Rx8 on DIMM module label



The DIMM only fits in one correct orientation. It will cause permanent damage to the motherboard and the DIMM if you force the DIMM into the slot at incorrect orientation.

1

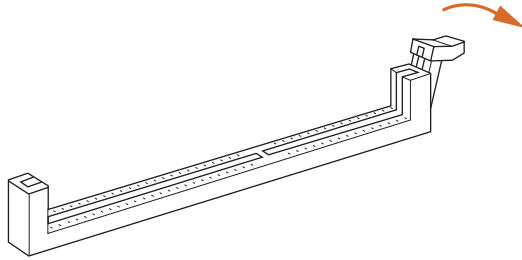

2

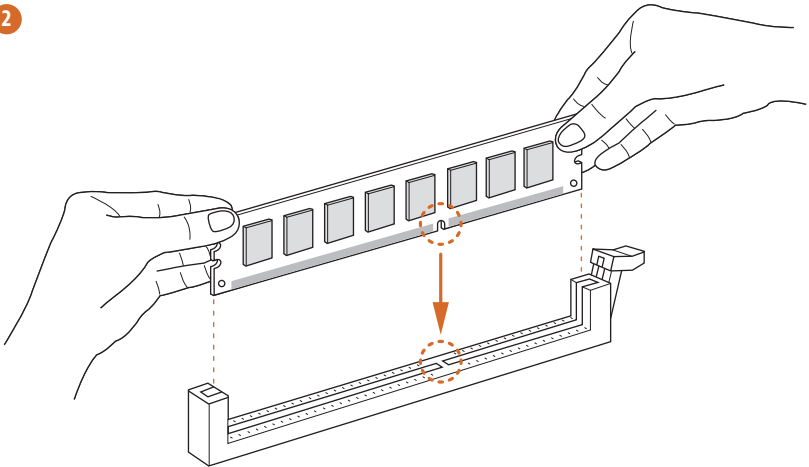

3

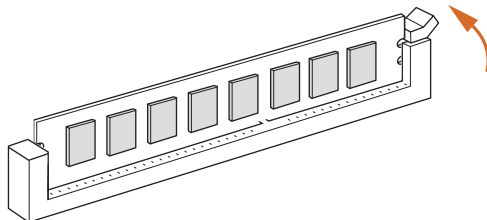

2.4 Expansion Slots (PCI Express Slots)

There is 1 PCI Express slot on the motherboard.



Before installing an expansion card, please make sure that the power supply is switched off or the power cord is unplugged. Please read the documentation of the expansion card and make necessary hardware settings for the card before you start the installation.

PCIe slots:

PCIe1 (PCIe 4.0 x16 slot) is used for PCI Express x16 lane width graphics cards.

PCIe Slot Configurations

	PCIe1
Ryzen Series CPUs (Matisse)	Gen4x16
Ryzen Series CPUs (Pinnacle Ridge)	Gen3x16
Ryzen Series CPUs (Picasso)	Gen3x8



For a better thermal environment, please connect a chassis fan to the motherboard's chassis fan connector (CHA_FAN1/WP) when using multiple graphics cards.

2.5 Onboard Headers and Connectors



Onboard headers and connectors are NOT jumpers. Do NOT place jumper caps over these headers and connectors. Placing jumper caps over the headers and connectors will cause permanent damage to the motherboard.

System Panel Header
(9-pin PANEL1)
(see p.7, No. 14)

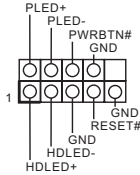

Connect the power button, reset button and system status indicator on the chassis to this header according to the pin assignments below. Note the positive and negative pins before connecting the cables.



PWRBTN (Power Button):

Connect to the power button on the chassis front panel. You may configure the way to turn off your system using the power button.

RESET (Reset Button):

Connect to the reset button on the chassis front panel. Press the reset button to restart the computer if the computer freezes and fails to perform a normal restart.

PLED (System Power LED):

Connect to the power status indicator on the chassis front panel. The LED is on when the system is operating. The LED keeps blinking when the system is in S1/S3 sleep state. The LED is off when the system is in S4 sleep state or powered off (S5).

HDLED (Hard Drive Activity LED):

Connect to the hard drive activity LED on the chassis front panel. The LED is on when the hard drive is reading or writing data.

The front panel design may differ by chassis. A front panel module mainly consists of power button, reset button, power LED, hard drive activity LED, speaker and etc. When connecting your chassis front panel module to this header, make sure the wire assignments and the pin assignments are matched correctly.

Chassis Speaker Header
(4-pin SPEAKER1)
(see p.7, No. 15)

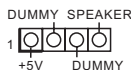

Please connect the chassis speaker to this header.

Serial ATA3 Connectors

- (SATA3_1:
see p.7, No. 10)
- (SATA3_2:
see p.7, No. 11)
- (SATA3_3:
see p.7, No. 12)
- (SATA3_4:
see p.7, No. 13)

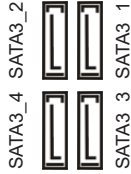

These four SATA3 connectors support SATA data cables for internal storage devices with up to 6.0 Gb/s data transfer rate.

USB 2.0 Header

- (9-pin USB_1_2)
(see p.7, No. 16)

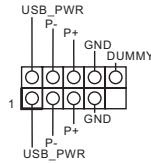

There is one header on this motherboard. Each USB 2.0 header can support two ports.

USB 3.2 Gen1 Header

- (19-pin USB3_3_4)
(see p.7, No. 8)

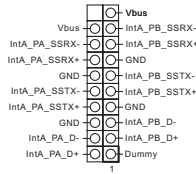

There is one header on this motherboard. Each USB 3.2 Gen1 header can support two ports.

Front Panel Audio Header

- (9-pin HD_AUDIO1)
(see p.7, No. 18)

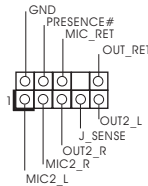

This header is for connecting audio devices to the front audio panel.



1. High Definition Audio supports Jack Sensing, but the panel wire on the chassis must support HDA to function correctly. Please follow the instructions in our manual and chassis manual to install your system.
2. If you use an AC'97 audio panel, please install it to the front panel audio header by the steps below:
 - A. Connect Mic_IN (MIC) to MIC2_L.
 - B. Connect Audio_R (RIN) to OUT2_R and Audio_L (LIN) to OUT2_L.
 - C. Connect Ground (GND) to Ground (GND).
 - D. MIC_RET and OUT_RET are for the HD audio panel only. You don't need to connect them for the AC'97 audio panel.
 - E. To activate the front mic, go to the "FrontMic" Tab in the Realtek Control panel and adjust "Recording Volume".

Chassis /Water Pump Fan Connector
(4-pin CHA_FAN1/WP)
(see p.7, No.4)

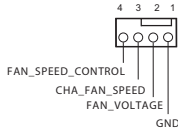

This motherboard provides a 4-Pin water cooling chassis fan connectors. If you plan to connect a 3-Pin chassis water cooler fan, please connect it to Pin 1-3.

CPU Fan Connector
(4-pin CPU_FAN1)
(see p.7, No. 9)

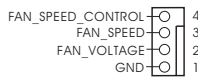

This motherboard provides a 4-Pin CPU fan (Quiet Fan) connector. If you plan to connect a 3-Pin CPU fan, please connect it to Pin 1-3.

CPU Water Pump Fan Connector
(4-pin CPU_FAN2/WP)
(see p.7, No. 2)

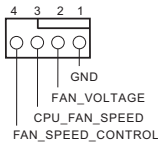

This motherboard provides a 4-Pin water cooling CPU fan connector. If you plan to connect a 3-Pin CPU water cooler fan, please connect it to Pin 1-3.

ATX Power Connector
(24-pin ATXPWR1)
(see p.7, No. 7)

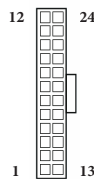

This motherboard provides a 24-pin ATX power connector. To use a 20-pin ATX power supply, please plug it along Pin 1 and Pin 13.

ATX 12V Power
Connector
(8-pin ATX12V1)
(see p.7, No. 1)

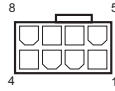

This motherboard provides an 8-pin ATX 12V power connector. To use a 4-pin ATX power supply, please plug it along Pin 1 and Pin 5.

***Warning: Please make sure that the power cable connected is for the CPU and not the graphics card. Do not plug the PCIe power cable to this connector.**

SPI TPM Header
(13-pin SPI_TPM_J1)
(see p.7, No. 17)

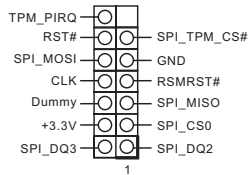

This connector supports SPI Trusted Platform Module (TPM) system, which can securely store keys, digital certificates, passwords, and data. A TPM system also helps enhance network security, protects digital identities, and ensures platform integrity.

RGB LED Header
(4-pin RGB_HEADER1)
(see p.7, No. 3)



This RGB header is used to connect RGB LED extension cable which allows users to choose from various LED lighting effects.

Caution: Never install the RGB LED cable in the wrong orientation; otherwise, the cable may be damaged.

*Please refer to page 42 for further instructions on this header.

Addressable LED Header
(3-pin ADDR_LED1)
(see p.7, No. 6)



This header is used to connect Addressable LED extension cable which allows users to choose from various LED lighting effects.

Caution: Never install the Addressable LED cable in the wrong orientation; otherwise, the cable may be damaged.

*Please refer to page 43 for further instructions on this header.

2.6 Smart Switches

The motherboard has a smart switch: Clear CMOS Button, allowing users to quickly flash the BIOS.

Clear CMOS Button
(CLRCBTN)
(see p.10, No. 14)



Clear CMOS Button
allows users to quickly
clear the CMOS values.



This function is workable only when you power off your computer and unplug the power supply.

2.7 M.2_SSD (NGFF) Module Installation Guide

The M.2, also known as the Next Generation Form Factor (NGFF), is a small size and versatile card edge connector that aims to replace mPCIe and mSATA. The Hyper M.2 Socket supports type 2280 M.2 PCI Express module up to Gen4x4 (64 Gb/s) (with Matisse) or Gen3x4 (32 Gb/s) (with Pinnacle Ridge and Picasso).

Installing the M.2_SSD (NGFF) Module

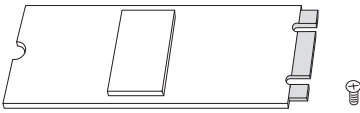

Step 1

Prepare a M.2_SSD (NGFF) module and the screw.

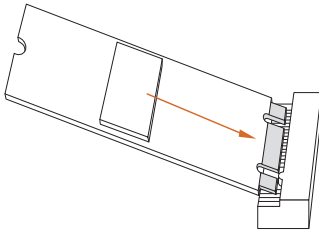

Step 2

Gently insert the M.2 (NGFF) SSD module into the M.2 slot. Please be aware that the M.2 (NGFF) SSD module only fits in one orientation.

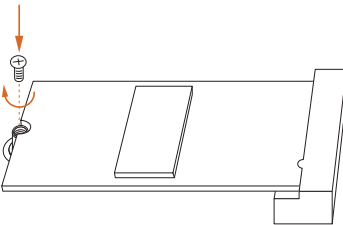
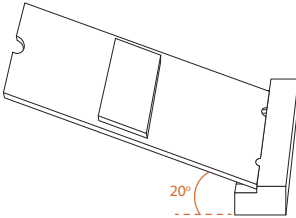

Step 3

Tighten the screw with a screwdriver to secure the module into place. Please do not overtighten the screw as this might damage the module.

M.2_SSD (NGFF) Module Support List

Vendor	Interface	P/N
SanDisk	PCIe	SanDisk-SD6PP4M-128G(Gen2 x2)
Intel	PCIe	INTEL 6000P-SSDPEKKF256G7 (nvme)
Intel	PCIe	INTEL 6000P-SSDPEKKF512G7 (nvme)
Intel	PCIe	SSDPEKKF512G7 NVME / 512GB
Kingston	PCIe	Kingston SHPM2280P2 / 240G (Gen2 x4)
Samsung	PCIe	Samsung XP941-MZHPU512HCGL(Gen2x4)
Samsung	PCIe	SM951 (NVME) / 512GB
Samsung	PCIe	SM951 (MZHPV512HDGL) / 512GB
ADATA	PCIe	ASX8000NP-512GM-C / 512GB
ADATA	PCIe	ASX7000NP-512GT-C / 512GB
Kingston	PCIe	SKC1000/480G
Kingston	PCIe	SKC1000/960GB NVME
PLEXTOR	PCIe	PX-512M8PeG/ 512GB
WD	PCIe	WDS512G1X0C-00ENX0 (NVME) / 512GB

For the latest updates of M.2_SSD (NFGG) module support list, please visit our website for details: <http://www.asrock.com>

Chapter 3 Software and Utilities Operation

3.1 Installing Drivers

The Support CD that comes with the motherboard contains necessary drivers and useful utilities that enhance the motherboard's features.

Running The Support CD

To begin using the support CD, insert the CD into your CD-ROM drive. The CD automatically displays the Main Menu if "AUTORUN" is enabled in your computer. If the Main Menu does not appear automatically, locate and double click on the file "ASRSETUP.EXE" in the Support CD to display the menu.

Drivers Menu

The drivers compatible to your system will be auto-detected and listed on the support CD driver page. Please click **Install All** or follow the order from top to bottom to install those required drivers. Therefore, the drivers you install can work properly.

Utilities Menu

The Utilities Menu shows the application software that the motherboard supports. Click on a specific item then follow the installation wizard to install it.

3.2 Phantom Gaming Tuning

Phantom Gaming Tuning is ASRock's multi purpose software suite with a new interface, more new features and improved utilities.

3.2.1 Installing Phantom Gaming Tuning

Phantom Gaming Tuning can be downloaded from ASRock Live Update & APP Shop. After the installation, you will find the icon "Phantom Gaming Tuning" on your desktop. Double-click the "Phantom Gaming Tuning"  icon, Phantom Gaming Tuning main menu will pop up.

3.2.2 Using Phantom Gaming Tuning

There are five sections in Phantom Gaming Tuning main menu: Operation Mode, OC Tweaker, System Info, FAN-Tastic Tuning and Settings.

Operation Mode

Choose an operation mode for your computer.

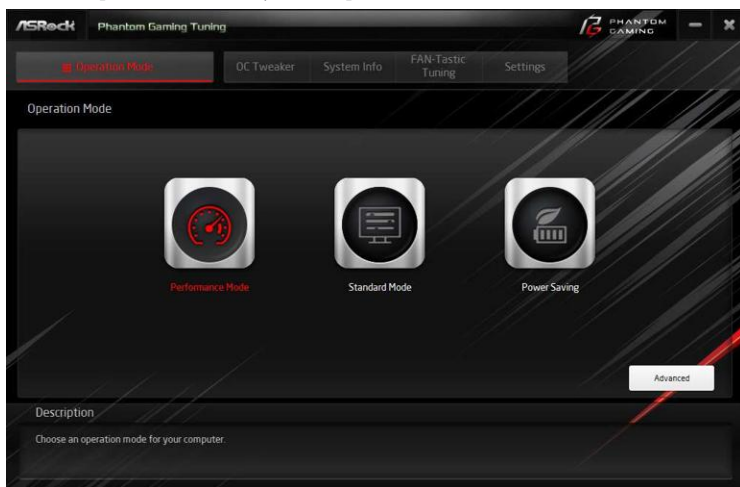

OC Tweaker

Configurations for overclocking the system.



System Info

View information about the system.

*The System Browser tab may not appear for certain models.

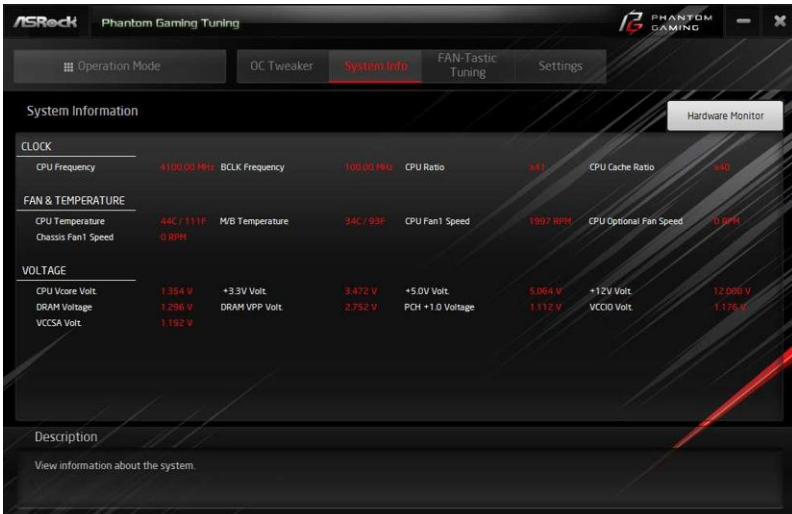

FAN-Tastic Tuning

Configure up to five different fan speeds using the graph. The fans will automatically shift to the next speed level when the assigned temperature is met.

The screenshot shows the 'FAN-Tastic Tuning' window in ASRock Phantom Gaming Tuning. The window has a dark theme with a red accent. At the top, there are tabs for 'Operation Mode', 'OC Tweaker', 'System Info', 'FAN-Tastic Tuning' (selected), and 'Settings'. Below the tabs, the 'FAN-Tastic Tuning' section is active. It features a dropdown menu for 'CHASSIS FAN1', radio buttons for 'CPU Temp.' and 'MB Temp.', and a 'Start FAN Test' button. A line graph plots 'FAN Speed (%)' on the y-axis (0 to 100) against 'Temperature (°C)' on the x-axis (0 to 100). The graph shows a step-like curve with points at approximately (50, 30), (60, 30), (65, 35), (70, 50), (75, 70), and (95, 100). To the right of the graph is a table with columns 'Fan Power' and 'Fan Speed'. Below the table is an 'Auto apply when program starts' checkbox and 'Apply' and 'Cancel' buttons. An illustration of a computer case with a fan is also visible.

Fan Power	Fan Speed
100%	N/A RPM
90%	N/A RPM
80%	N/A RPM
70%	N/A RPM
60%	N/A RPM
50%	N/A RPM
40%	N/A RPM
30%	N/A RPM
20%	N/A RPM
10%	N/A RPM

Auto apply when program starts

Description
Configure different fan speeds for respective temperatures using the graph.
The fans will automatically shift to the next speed level when the assigned temperature is met.

Settings

Configure ASRock Phantom Gaming Tuning. Click to select "Auto run at Windows Startup" if you want Phantom Gaming Tuning to be launched when you start up the Windows operating system.

The screenshot shows the 'Settings' window in ASRock Phantom Gaming Tuning. The window has a dark theme with a red accent. At the top, there are tabs for 'Operation Mode', 'OC Tweaker', 'System Info', 'FAN-Tastic Tuning', and 'Settings' (selected). Below the tabs, the 'Settings' section is active. It features a checkbox for 'Auto run at Windows Startup'. At the bottom right, the version number 'Version 1.30.230' is displayed. A 'Description' section at the bottom contains the text 'Configure ASRock Phantom Gaming'.

Auto run at Windows Startup

Version 1.30.230

Description
Configure ASRock Phantom Gaming

3.3 ASRock Live Update & APP Shop

The ASRock Live Update & APP Shop is an online store for purchasing and downloading software applications for your ASRock computer. You can quickly and easily install various apps and support utilities. With ASRock Live Update & APP Shop, you can optimize your system and keep your motherboard up to date simply with a few clicks.

Double-click  on your desktop to access ASRock Live Update & APP Shop utility.

**You need to be connected to the Internet to download apps from the ASRock Live Update & APP Shop.*

3.3.1 UI Overview

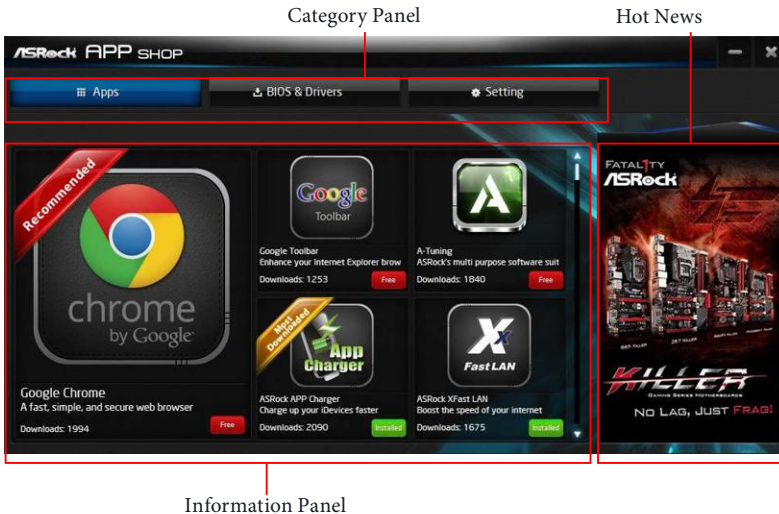

Category Panel: The category panel contains several category tabs or buttons that when selected the information panel below displays the relative information.

Information Panel: The information panel in the center displays data about the currently selected category and allows users to perform job-related tasks.

Hot News: The hot news section displays the various latest news. Click on the image to visit the website of the selected news and know more.

3.3.2 Apps

When the "Apps" tab is selected, you will see all the available apps on screen for you to download.

Installing an App

Step 1

Find the app you want to install.



The most recommended app appears on the left side of the screen. The other various apps are shown on the right. Please scroll up and down to see more apps listed.

You can check the price of the app and whether you have already installed it or not.

 - The red icon displays the price or "Free" if the app is free of charge.

 - The green "Installed" icon means the app is installed on your computer.

Step 2

Click on the app icon to see more details about the selected app.

Step 3

If you want to install the app, click on the red icon  to start downloading.

**Step 4**

When installation completes, you can find the green "Installed" icon appears on the upper right corner.



To uninstall it, simply click on the trash can icon .
*The trash icon may not appear for certain apps.

Upgrading an App

You can only upgrade the apps you have already installed. When there is an available new version for your app, you will find the mark of "New Version"  appears below the installed app icon.



Step 1

Click on the app icon to see more details.

Step 2

Click on the yellow icon  to start upgrading.

3.3.3 BIOS & Drivers

Installing BIOS or Drivers

When the "BIOS & Drivers" tab is selected, you will see a list of recommended or critical updates for the BIOS or drivers. Please update them all soon.

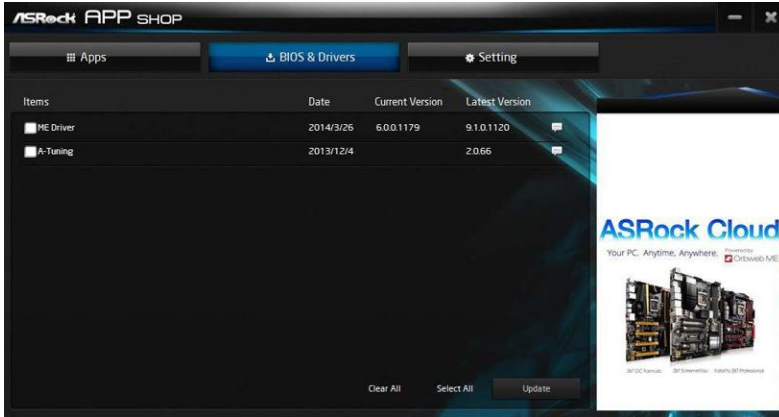

Step 1

Please check the item information before update. Click on  to see more details.

Step 2

Click to select one or more items you want to update.

Step 3

Click Update to start the update process.

3.3.4 Setting

In the "Setting" page, you can change the language, select the server location, and determine if you want to automatically run the ASRock Live Update & APP Shop on Windows startup.

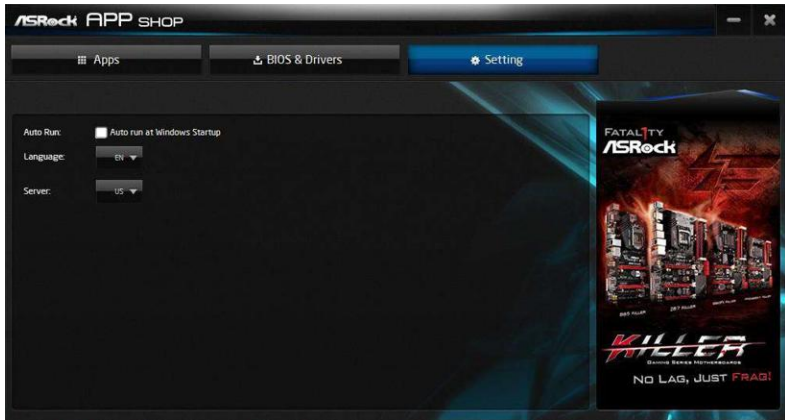

3.4 Creative SoundBlaster Cinema5

The SoundBlaster™ Cinema5, powered by the SBX Pro Studio technologies, is designed to bring the same great audio experience found in live performances, films, and recording studios to the PC. With this utility, you can easily enhance your audio environment in five modes, including Headphones, Speakers, Music, Movie, Game, Voice and Custom.

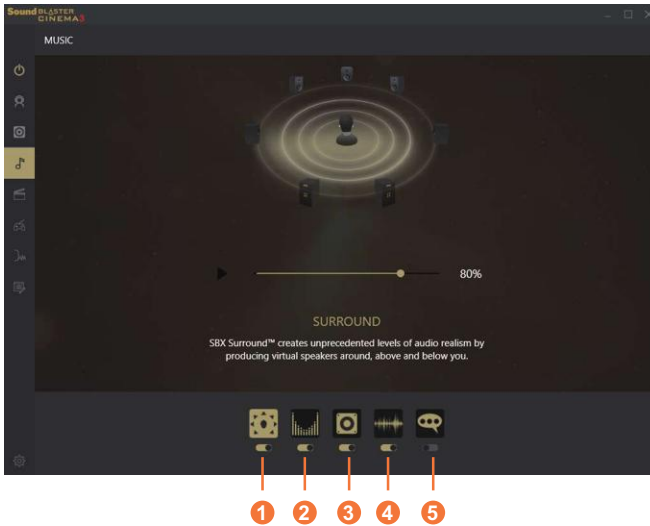

There are five functions in SoundBlaster™ Cinema5:

No.	Function	Description
1	Surround	Creating unprecedented levels of audio realism by producing virtual speakers around, above and below you.
2	Crystalizer	Making music sound as good as the artist originally intended by ensuring that every audio detail is heard.
3	Bass	Enhancing bass sound experience by expanding the low frequency tones.
4	Smart Volume	Minimizing abrupt volume changes by automatically adjusting the loudness of your audio playback.
5	Dialog Plus	Enhancing voices in music and movies for drastically clearer vocal range.

3.5 ASRock Polychrome SYNC

ASRock Polychrome SYNC is a lighting control utility specifically designed for unique individuals with sophisticated tastes to build their own stylish colorful lighting system. Simply by connecting the LED strip, you can customize various lighting schemes and patterns, including Static, Breathing, Strobe, Cycling, Music, Wave and more.

Connecting the LED Strip

Connect your RGB LED strip to the **RGB LED Header (RGB_HEADER1)** on the motherboard.

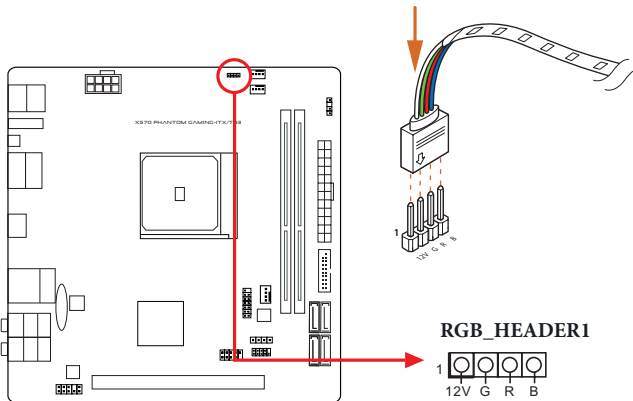

1. Never install the RGB LED cable in the wrong orientation; otherwise, the cable may be damaged.
2. Before installing or removing your RGB LED cable, please power off your system and unplug the power cord from the power supply. Failure to do so may cause damages to motherboard components.



1. Please note that the RGB LED strips do not come with the package.
2. The RGB LED header supports standard 5050 RGB LED strip (12V/G/R/B), with a maximum power rating of 3A (12V) and length within 2 meters.

Connecting the Addressable RGB LED Strip

Connect your Addressable RGB LED strip to the **Addressable LED Header (ADDR_LED1)** on the motherboard.

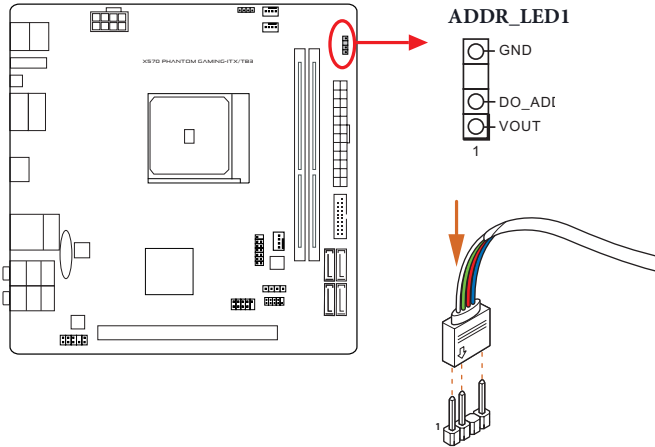

1. Never install the RGB LED cable in the wrong orientation; otherwise, the cable may be damaged.
2. Before installing or removing your RGB LED cable, please power off your system and unplug the power cord from the power supply. Failure to do so may cause damages to motherboard components.



1. Please note that the RGB LED strips do not come with the package.
2. The RGB LED header supports WS2812B addressable RGB LED strip (5V/Data/GND), with a maximum power rating of 3A (5V) and length within 2 meters.

ASRock Polychrome SYNC Utility

Now you can adjust the RGB LED color through the ASRock RGB LED utility. Download this utility from the ASRock Live Update & APP Shop and start coloring your PC style your way!

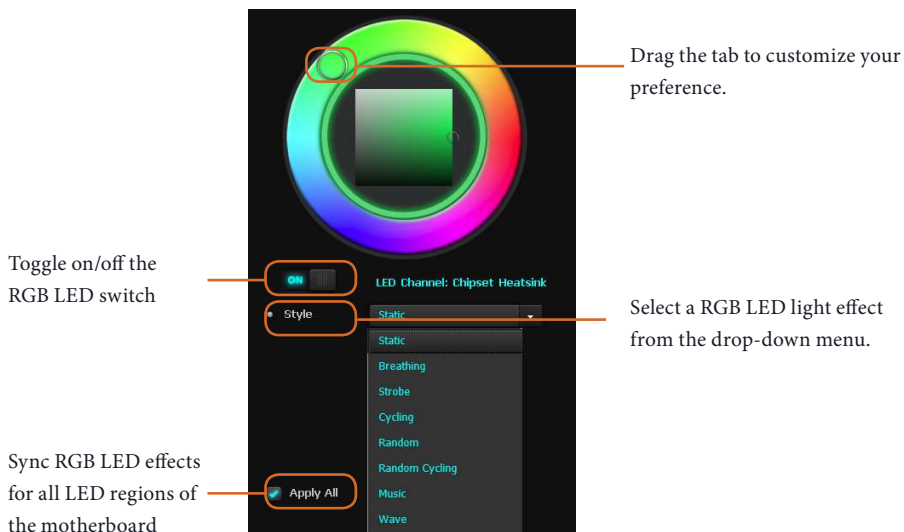

Chapter 4 UEFI SETUP UTILITY

4.1 Introduction

This section explains how to use the UEFI SETUP UTILITY to configure your system. You may run the UEFI SETUP UTILITY by pressing <F2> or right after you power on the computer, otherwise, the Power-On-Self-Test (POST) will continue with its test routines. If you wish to enter the UEFI SETUP UTILITY after POST, restart the system by pressing <Ctl> + <Alt> + <Delete>, or by pressing the reset button on the system chassis. You may also restart by turning the system off and then back on.



Because the UEFI software is constantly being updated, the following UEFI setup screens and descriptions are for reference purpose only, and they may not exactly match what you see on your screen.

4.1.1 UEFI Menu Bar

The top of the screen has a menu bar with the following selections:

Main	For setting system time/date information
OC Tweaker	For overclocking configurations
Advanced	For advanced system configurations
Tool	Useful tools
H/W Monitor	Displays current hardware status
Security	For security settings
Boot	For configuring boot settings and boot priority
Exit	Exit the current screen or the UEFI Setup Utility

4.1.2 Navigation Keys

Use <←> key or <→> key to choose among the selections on the menu bar, and use <↑> key or <↓> key to move the cursor up or down to select items, then press <Enter> to get into the sub screen. You can also use the mouse to click your required item.

Please check the following table for the descriptions of each navigation key.

Navigation Key(s)	Description
+ / -	To change option for the selected items
<Tab>	Switch to next function
<PGUP>	Go to the previous page
<PGDN>	Go to the next page
<HOME>	Go to the top of the screen
<END>	Go to the bottom of the screen
<F1>	To display the General Help Screen
<F7>	Discard changes and exit the SETUP UTILITY
<F9>	Load optimal default values for all the settings
<F10>	Save changes and exit the SETUP UTILITY
<F12>	Print screen
<ESC>	Jump to the Exit Screen or exit the current screen

4.2 Main Screen

When you enter the UEFI SETUP UTILITY, the Main screen will appear and display the system overview.



4.3 OC Tweaker Screen

In the OC Tweaker screen, you can set up overclocking features.



Because the UEFI software is constantly being updated, the following UEFI setup screens and descriptions are for reference purpose only, and they may not exactly match what you see on your screen.

CPU Configuration

Spread Spectrum

Enable Spread Spectrum to reduce electromagnetic interference for passing EMI tests. Disable to achieve higher clock speeds when overclocking.

CPU Frequency and Voltage Change

If this item is set to [Manual], the multiplier and voltage will be set based on user selection. Final result is depending on the CPU's capability.

SoC/Uncore OC Voltage

Specify the SoC/Uncore voltage (VDD_SOC) in mV to support memory and Infinity Fabric overclocking. VDD_SOC also determines the GPU voltage on processors with integrated graphics.

“SoC/Uncore OC Mode” need to be enabled to force this voltage.

SMT Mode

This item can be used to disable symmetric multithreading. To re-enable SMT, a power cycle is needed after selecting [Auto].

Warning: S3 is not supported on systems where SMT is disabled.

DRAM Timing Configuration

DRAM Information

Browse the serial presence detect (SPD) for DDR4 modules.

Load DRAM Profile

Load DRAM profile to overclock the memory and perform beyond standard specifications.

Load XMP Setting

Load XMP settings to overclock the memory and perform beyond standard specifications.

DRAM Frequency

If [Auto] is selected, the motherboard will detect the memory module(s) inserted and assign the appropriate frequency automatically.

Infinity Fabric Frequency and Dividers

Set Infinity Fabric Frequency and Dividers (FCLK).

GFX Clock Frequency (Only for processor with integrated graphics)

This item allows you to alter the frequency for the GFX clock frequency. After you alter the GFX Clock Frequency settings, make sure to adjust the GFX Core Voltage settings.

*The adjustable range is dependent on the CPU being installed.

GFX Core Voltage (Only for processor with integrated graphics)

This item allows you to alter the voltage for the GFX Core Voltage.

*The adjustable range is dependent on the CPU being installed.

Voltage Configuration

Voltage Mode

[OC]

If this option is selected, there is larger range voltage for overclocking.

[Stable]

If this option is selected, there is smaller range voltage for stable system.

CPU Vcore Voltage

Configure the voltage for the CPU Vcore.

CPU Vcore Load-Line Calibration

CPU Load-Line Calibration helps prevent CPU voltage droop when the system is under heavy loading.

CPU VDDCR_SOC Voltage

Configure the voltage for the VID-requested VDDCR_SOC supply level.

CPU VDDCR_SOC Load-Line Calibration

VDDCR_SOC Load-Line Calibration helps prevent VDDCR_SOC voltage droop when the system is under heavy loading.

VDDG Voltage Control

VDDG represents voltage for the data portion of the Infinity Fabric. It is derived from the CPU SoC/Uncore Voltage (VDD_SOC). VDDG can approach but not exceed VDD_SOC.

DRAM Voltage

Use this to select DRAM Voltage. The default value is [Auto].

VPPM

Configure the voltage for the VPPM.

VDDP

Configure the voltage for the VDDP.

CPU VDD 1.8 Voltage

Configure the voltage for the CPU VDD 1.8 PROM.

PREM VDD_CLDO Voltage

Use this to select PREM VDD_CLDO Voltage. The default value is [Auto].

PREM VDDCR_SOC Voltage

Use this to select PREM VDDCR_SOC Voltage. The default value is [Auto].

Save User Default

Type a profile name and press enter to save your settings as user default.

Load User Default

Load previously saved user defaults.

Save User UEFI Setup Profile to Disk

Save current UEFI settings as an user default profile to disk.

Load User UEFI Setup Profile to Disk

Load previously saved user defaults from the disk.

4.4 Advanced Screen

In this section, you may set the configurations for the following items: CPU Configuration, Onboard Devices Configuration, Storage Configuration, ACPI Configuration, Trusted Computing, AMD CBS, AMD PBS and AMD Overclocking.



Setting wrong values in this section may cause the system to malfunction.

UEFI Configuration

Active Page on Entry

Select the default page when entering the UEFI setup utility.

Full HD UEFI

When [Auto] is selected, the resolution will be set to 1920 x 1080 if the monitor supports Full HD resolution. If the monitor does not support Full HD resolution, then the resolution will be set to 1024 x 768. When [Disable] is selected, the resolution will be set to 1024 x 768 directly.

4.4.1 CPU Configuration



PSS Support

Use this to enable or disable the generation of ACPI_PPC, _PSS, and _PCT objects.

NX Mode

Use this to enable or disable NX mode.

SVM Mode

When this is set to [Enabled], a VMM (Virtual Machine Architecture) can utilize the additional hardware capabilities provided by AMD-V. The default value is [Enabled]. Configuration options: [Enabled] and [Disabled].

SMT Mode

This item can be used to disable symmetric multithreading. To re-enable SMT, a power cycle is needed after selecting [Auto].

Warning: S3 is not supported on systems where SMT is disabled.

AMD fTPM Switch

Use this to enable or disable AMD CPU fTPM.

4.4.2 Onboard Devices Configuration



Turn On LED in S5

Turn on/off the LED in the ACPI S5 state.

SR-IOV Support

Enable/disable the SR-IOV (Single Root IO Virtualization Support) if the system has SR-IOV capable PCIe devices.

UMA Frame buffer Size (Only for processor with integrated graphics)

This item allows you to set the size of the UMA frame buffer.

Onboard HD Audio

Enable/disable onboard HD audio. Set to Auto to enable onboard HD audio and automatically disable it when a sound card is installed.

Front Panel

Enable/disable front panel HD audio.

Restore on AC/Power Loss

Select the power state after a power failure. If [Power Off] is selected, the power will remain off when the power recovers. If [Power On] is selected, the system will start to boot up when the power recovers.

WAN Radio

Configure the WiFi module's connectivity.

BT On/Off

Enable/disable the bluetooth.

PS2 Y-Cable

Enable the PS2 Y-Cable or set this option to Auto.

4.4.3 Storage Configuration



4.4.4 ACPI Configuration



Suspend to RAM

It is recommended to select auto for ACPI S3 power saving.

Deep Sleep

Configure deep sleep mode for power saving when the computer is shut down.

4.4.5 Trusted Computing

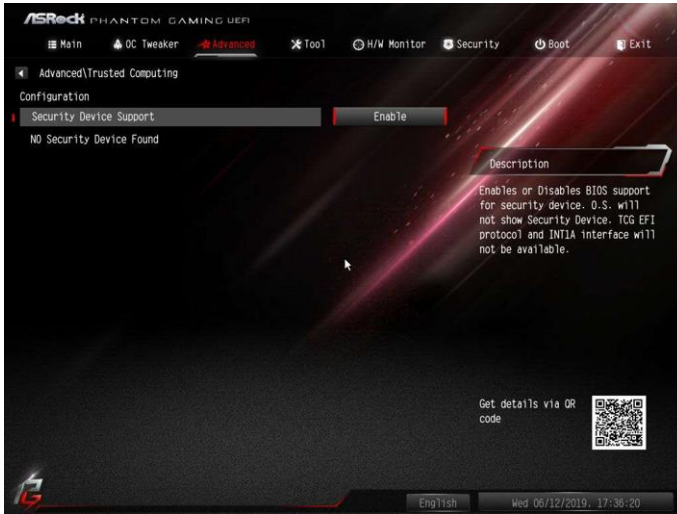

Security Device Support

Enable or disable BIOS support for security device.

4.4.6 AMD CBS



The AMD CBS menu accesses AMD specific features.

4.4.7 AMD PBS



The AMD PBS menu accesses AMD specific features.

4.4.8 AMD Overclocking



The AMD Overclocking menu accesses options for configuring CPU frequency and voltage.

4.5 Tools

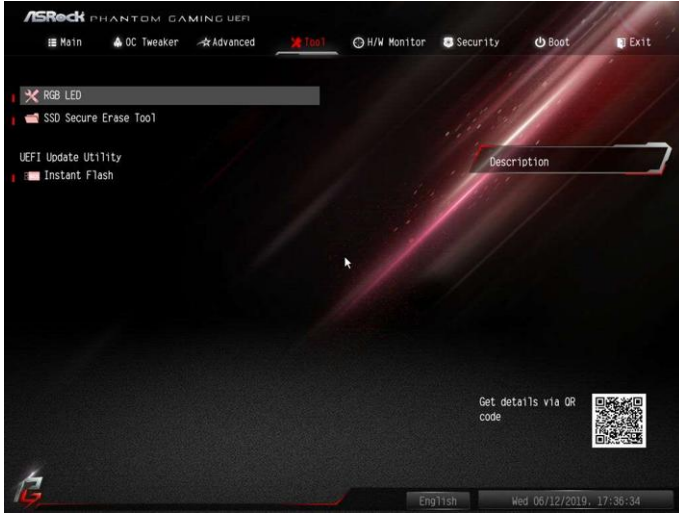

RGB LED

ASRock Polychrome SYNC allows you to adjust the RGB LED color to your liking.

SSD Secure Erase Tool

Use this tool to securely erase SSD.

Instant Flash

Save UEFI files in your USB storage device and run Instant Flash to update your UEFI.

4.6 Hardware Health Event Monitoring Screen

This section allows you to monitor the status of the hardware on your system, including the parameters of the CPU temperature, motherboard temperature, fan speed and voltage.

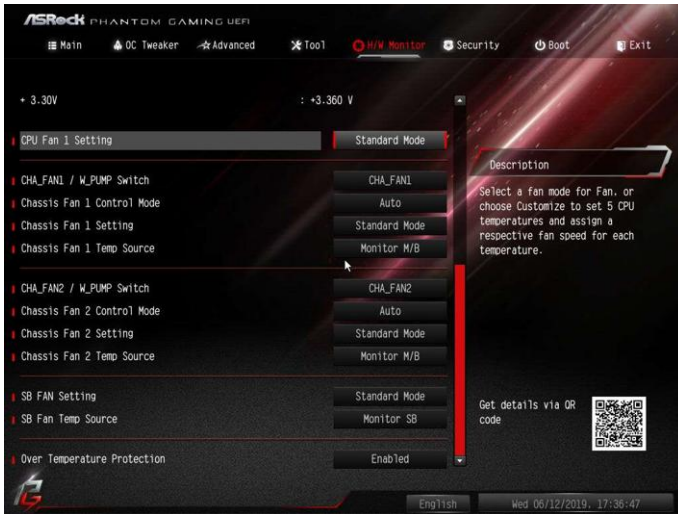

CPU_FAN1 Setting

Select a fan mode for CPU Fan 1, or choose Customize to set 5 CPU temperatures and assign a respective fan speed for each temperature.

CHA_FAN1 / W_PUMP Switch

Select CHA_FAN1 or Water Pump mode.

Chassis Fan 1 Control Mode

Select PWM mode or DC mode for Chassis Fan 1.

Chassis Fan 1 Setting

Select a fan mode for Chassis Fan 1, or choose Customize to set 5 CPU temperatures and assign a respective fan speed for each temperature.

Chassis Fan 1 Temp Source

Select a fan temperature source for Chassis Fan 1.

CHA_FAN2 / W_PUMP Switch

Select CHA_FAN2 or Water Pump mode.

Chassis Fan 2 Control Mode

Select PWM mode or DC mode for Chassis Fan 2 .

Chassis Fan 2 Setting

Select a fan mode for Chassis Fan 2, or choose Customize to set 5 CPU temperatures and assign a respective fan speed for each temperature.

Chassis Fan 2 Temp Source

Select a fan temperature source for Chassis Fan 2.

SB_FAN Setting

Select a fan mode for SB_FAN1, or choose Customize to set 5 CPU temperatures and assign a respective fan speed for each temperature.

SB_FAN Temp Source

Select a fan temperature source for SB_FAN1.

Over Temperature Protection

When Over Temperature Protection is enabled, the system automatically shuts down when the motherboard is overheated.

4.7 Security Screen

In this section you may set or change the supervisor/user password for the system. You may also clear the user password.



Supervisor Password

Set or change the password for the administrator account. Only the administrator has authority to change the settings in the UEFI Setup Utility. Leave it blank and press enter to remove the password.

User Password

Set or change the password for the user account. Users are unable to change the settings in the UEFI Setup Utility. Leave it blank and press enter to remove the password.

Secure Boot

Enable to support Secure Boot.

4.8 Boot Screen

This section displays the available devices on your system for you to configure the boot settings and the boot priority.



Boot From Onboard LAN

Allow the system to be waked up by the onboard LAN.

Boot Beep

Select whether the Boot Beep should be turned on or off when the system boots up. Please note that a buzzer is needed.

Setup Prompt Timeout

Configure the number of seconds to wait for the setup hot key.

Bootup Num-Lock

Select whether Num Lock should be turned on or off when the system boots up.

Full Screen Logo

Enable to display the boot logo or disable to show normal POST messages.

AddOn ROM Display

Enable AddOn ROM Display to see the AddOn ROM messages or configure the AddOn ROM if you've enabled Full Screen Logo. Disable for faster boot speed.

Fast Boot

Fast Boot minimizes your computer's boot time. In fast mode you may not boot from an USB storage device.

CSM (Compatibility Support Module)



CSM

Enable to launch the Compatibility Support Module. Please do not disable unless you're running a WHCK test.

Above 4G Decoding

Enable or disable 64bit capable Devices to be decoded in Above 4G Address Space (only if the system supports 64 bit PCI decoding).

Launch PXE OpROM Policy

Select UEFI only to run those that support UEFI option ROM only. Select Legacy only to run those that support legacy option ROM only. Select Do not launch to not execute both legacy and UEFI option ROM.

Launch Storage OpROM Policy

Select UEFI only to run those that support UEFI option ROM only. Select Legacy only to run those that support legacy option ROM only. Select Do not launch to not execute both legacy and UEFI option ROM.

4.9 Exit Screen



Save Changes and Exit

When you select this option the following message, “Save configuration changes and exit setup?” will pop out. Select [OK] to save changes and exit the UEFI SETUP UTILITY.

Discard Changes and Exit

When you select this option the following message, “Discard changes and exit setup?” will pop out. Select [OK] to exit the UEFI SETUP UTILITY without saving any changes.

Discard Changes

When you select this option the following message, “Discard changes?” will pop out. Select [OK] to discard all changes.

Load UEFI Defaults

Load UEFI default values for all options. The F9 key can be used for this operation.

Launch EFI Shell from filesystem device

Copy shellx64.efi to the root directory to launch EFI Shell.

Contact Information

If you need to contact ASRock or want to know more about ASRock, you're welcome to visit ASRock's website at <http://www.asrock.com>; or you may contact your dealer for further information. For technical questions, please submit a support request form at <https://event.asrock.com/tsd.asp>

ASRock Incorporation

2F., No.37, Sec. 2, Jhongyang S. Rd., Beitou District,

Taipei City 112, Taiwan (R.O.C.)

ASRock EUROPE B.V.

Bijsterhuizen 11-11

6546 AR Nijmegen

The Netherlands

Phone: +31-24-345-44-33

Fax: +31-24-345-44-38

ASRock America, Inc.

13848 Magnolia Ave, Chino, CA91710

U.S.A.

Phone: +1-909-590-8308

Fax: +1-909-590-1026

DECLARATION OF CONFORMITY

Per FCC Part 2 Section 2.1077(a)



Responsible Party Name: ASRock Incorporation

Address: 13848 Magnolia Ave, Chino, CA91710

Phone/Fax No: +1-909-590-8308/+1-909-590-1026

hereby declares that the product

Product Name : Motherboard

Model Number : X570 Phantom Gaming-ITX/TB3

Conforms to the following specifications:

FCC Part 15, Subpart B, Unintentional Radiators

Supplementary Information:

This device complies with part 15 of the FCC Rules. Operation is subject to the following two conditions: (1) This device may not cause harmful interference, and (2) this device must accept any interference received, including interference that may cause undesired operation.

Representative Person's Name: James

Signature:

A handwritten signature in black ink, appearing to read 'James', written over a horizontal line.

Date : May 12, 2017

EU Declaration of Conformity

ASRock®

For the following equipment:

Motherboard

(Product Name)

X570 Phantom Gaming-ITX/TB3 / ASRock

(Model Designation / Trade Name)

ASRock Incorporation

(Manufacturer Name)

2F, No.37, Sec. 2, Jhongyang S. Rd., Beitou District, Taipei City 112, Taiwan (R.O.C.)

(Manufacturer Address)

EMC — Directive 2014/30/EU (from April 20th, 2016)

EN 55022:2010/AC:2011 Class B

EN 55024:2010/A1:2015

EN 55032:2012+AC:2013 Class B

EN 61000-3-3:2013

EN 61000-3-2:2014

RED—Directive 2014/53/EU

EN 300 328 V2.1.1

EN 301 489-17 V3.1.1

EN 301 893 V2.1.1

EN 301 489-3 V2.1.1

EN 300 220 V3.1.1

LVD — Directive 2014/35/EU (from April 20th, 2016)

EN 60950-1 : 2011+ A2: 2013

EN 60950-1 : 2006/A12: 2011

RoHS — Directive 2011/65/EU

CE marking



(EU conformity marking)

ASRock EUROPE B.V.

(Company Name)

Bijsterhuizen 1111 6546 AR Nijmegen The Netherlands

(Company Address)

Person responsible for making this declaration:

(Name, Surname)

A.V.P

(Position / Title)

July 16, 2019

(Date)

P/N: 15G062174000AK V1.0