

Intel® Solid-State Drive DC P3600 Series

Product Specification

- Capacities:
 - 400GB, 800GB, 1.2TB, 1.6TB, 2TB
- PCIe* Gen3 X4
- Form Factors
 - 2.5-inch Form Factor
 - 15mm Z-height
 - 8639-compatible connector
 - AIC Form Factor
 - Half-height, Half-length
 - Single slot x4 connector
- Performance^{1,2}
 - Seq R/W: Up to 2600/1700MB/s³
 - IOPS Rnd 70/30 R/W 4KB⁴: Up to 160K
 - IOPS Rnd 4KB⁴ R/W: Up to 450/56K
 - Seq Latency (typ) R/W: 20/20µs
- Components
 - Intel® 20nm MLC NAND Flash Memory
- Operating System Support:
 - Windows* Server 2012 R2, 2012, 2008 R2 x64
 - RHEL* 6.5, 7.0
 - UEFI 2.3.1
- Reliability
 - Uncorrectable Bit Error Rate (UBER): 1 sector per 10¹⁷ bits read
 - Mean Time Before Failure (MTBF): 2 million hours
 - T10 DIF protection
 - Variable Sector Size: 512, 520, 528, 4096, 4104, 4160, 4224 Bytes
- Power
 - 2.5-inch: 3.3V and 12V Supply Rail
 - AIC: 3.3V and 12V Supply Rail
 - Enhanced power-loss data protection
 - Active/Idle (TYP): Up to 25W/4W (TYP)
- Compliance
 - NVM Express* 1.0
 - PCI Express Base Specification Rev 3.0
 - Enterprise SSD Form Factor Version 1.0a
 - PCI Express Card Electro-Mechanical (CEM) Specification Rev 2.0
- Certifications and Declarations
 - UL*, CE*, C-Tick*, BSMI*, KCC*, Microsoft WHQL*, VCCI*
- Endurance Rating
 - Up to 10.95 PBW (Petabytes Written)⁵ 3 Drive Writes/day (JESD219 workload)
- Temperature Specification
 - Operating:
 - AIC: 0 to 55° C with specified airflow
 - 2.5-inch: 0 to 35° C ambient, 0 to 70° C case with specified airflow
 - Non-Operating⁶: -55 to 95° C
 - Temperature monitoring (In-band and by way of SMBUS)
 - Thermal throttling
- Airflow
 - AIC (55° C airflow towards IO bracket⁷)
 - 400 GB: 100 LFM
 - 800GB/1.2TB/1.6TB/2.0TB: 300 LFM
 - 2.5-inch (Airflow towards the connector)
 - 400GB: 250/300 LFM (25/35° C)
 - 800GB: 350/500 LFM (25/35° C)
 - 1.2TB/1.6TB/2.0TB: 450/650 LFM (25/35° C)
- Weight
 - AIC: 400/800GB up to 185gm 1.2TB, 1.6TB, 2TB up to 195gm
 - 2.5-inch: 400/800GB up to 115 gm 1.2TB, 1.6TB, 2TB up to 125gm
- Shock
 - 2.5-inch: 1,000 G/0.5msec
 - AIC: 50 G Trapezoidal, 170 in/s
- Vibration
 - Operating: 2.17 G_{RMS} (5-700Hz)
 - Non-Operating: 3.13 G_{RMS} (5-800Hz)
- Altitude (Simulated)
 - Operating: -1,000 to 10,000 ft
 - Non-Operating: -1,000 to 40,000 ft
- Product Ecological Compliance
 - RoHS

1. Performance values vary by capacity and form factor
2. Performance specifications apply to both compressible and incompressible data
3. MB/s = 1,000,000 bytes/second
4. 4KB = 4,096 bytes; 8 KB = 8,192 bytes
5. 1PB = 10¹⁵ Bytes
6. Please contact your Intel representative for details on the non-operating temperature range
7. Airflow out of server through PCIe Card Slot

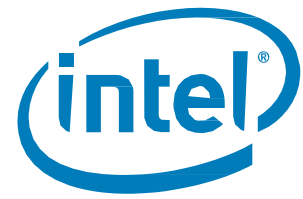

Ordering Information

Contact your local Intel sales representative for ordering information.

INFORMATION IN THIS DOCUMENT IS PROVIDED IN CONNECTION WITH INTEL PRODUCTS. NO LICENSE, EXPRESS OR IMPLIED, BY ESTOPPEL OR OTHERWISE, TO ANY INTELLECTUAL PROPERTY RIGHTS IS GRANTED BY THIS DOCUMENT. EXCEPT AS PROVIDED IN INTEL'S TERMS AND CONDITIONS OF SALE FOR SUCH PRODUCTS, INTEL ASSUMES NO LIABILITY WHATSOEVER AND INTEL DISCLAIMS ANY EXPRESS OR IMPLIED WARRANTY, RELATING TO SALE AND/OR USE OF INTEL PRODUCTS INCLUDING LIABILITY OR WARRANTIES RELATING TO FITNESS FOR A PARTICULAR PURPOSE, MERCHANTABILITY, OR INFRINGEMENT OF ANY PATENT, COPYRIGHT OR OTHER INTELLECTUAL PROPERTY RIGHT.

UNLESS OTHERWISE AGREED IN WRITING BY INTEL, THE INTEL PRODUCTS ARE NOT DESIGNED NOR INTENDED FOR ANY APPLICATION IN WHICH THE FAILURE OF THE INTEL PRODUCT COULD CREATE A SITUATION WHERE PERSONAL INJURY OR DEATH MAY OCCUR.

Intel may make changes to specifications and product descriptions at any time, without notice. Designers must not rely on the absence or characteristics of any features or instructions marked "reserved" or "undefined." Intel reserves these for future definition and shall have no responsibility whatsoever for conflicts or incompatibilities arising from future changes to them. The information here is subject to change without notice. Do not finalize a design with this information.

The products described in this document may contain design defects or errors known as errata which may cause the product to deviate from published specifications. Current characterized errata are available on request.

Contact your local Intel sales office or your distributor to obtain the latest specifications and before placing your product order. This document contains information on products in the design phase of development.

Copies of documents which have an order number and are referenced in this document, or other Intel literature, may be obtained by calling 1-800-548-4725, or go to: <http://www.intel.com/design/literature.htm> Intel and the Intel logo are trademarks of Intel Corporation in the U.S. and other countries.

*Other names and brands may be claimed as the property of others. Copyright © 2014 Intel Corporation. All rights reserved.

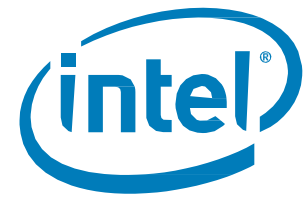

Contents

1	Overview	7
1.1	References	8
1.2	Terms and Acronyms	9
2	Product Specifications	10
2.1	Capacity	10
2.2	Performance	10
2.3	Electrical Characteristics	12
2.4	Environmental Conditions	13
2.5	Product Regulatory Compliance	15
2.6	Reliability Specifications	16
2.7	Temperature Sensor	16
2.8	Power Loss Capacitor Test	16
2.9	Hot Plug Support	17
2.10	Out of Band Management (SMBUS)	17
2.11	Variable Sector Size Support	17
3	Mechanical Information	18
4	Pin and Signal Descriptions	20
4.1	2.5-inch Form Factor Pin Locations	20
4.2	Pin Signal Definitions	20
5	Supported Command Sets	23
5.1	NVMe* Admin Command Set	23
5.2	NVMe* I/O Command Set	23
5.3	Log Page Support	24
5.4	SMART Attributes	24
5.5	Temperature Statistics	27
5.6	Drive Marketing Name Log	27
5.7	SET Feature Identifiers	27
6	NVMe* Driver Support	29
7	Certifications and Declarations	30
Appendix A	IDENTIFY Data Structure	31
Appendix B	Vital Data Structure	38
Appendix C	Out of Band Temperature Sensor Read Out	39
Appendix D	PCIe* ID	40
Appendix E	SCSI Command Translation	41
Appendix F	Add-in Card LED Decoder	42



Figures

Figure 3-1	Intel® SSD DC P3600 Series SFF Dimensions.....	18
Figure 3-2	Intel® SSD DC P3600 Series PCIe* Dimensions	19
Figure 4-1	2.5-inch Form Factor Pin Locations.....	20
Figure A-1	LED Location	42

Tables

Table 1:	Standard Information Referenced in this Document.....	8
Table 2:	Glossary of Terms and Acronyms	9
Table 3:	User Addressable Sectors.....	10
Table 4:	Random Read/Write Input/Output Operations Per Second (IOPS)	10
Table 5:	Random Read/Write IOPS Consistency.....	11
Table 6:	Sequential Read and Write Bandwidth	11
Table 7:	Latency	11
Table 8:	Quality of Service	12
Table 9:	Operating Voltage	12
Table 10:	Power Consumption	13
Table 11:	Temperature, Shock, Vibration	13
Table 12:	Airflow Requirements for Intel® SSD DC P3600 Series (Add-In Card)	14
Table 13:	Airflow Requirements for Intel® SSD DC P3600 Series (2.5-inch Form Factor)	14
Table 14:	Product Regulatory Compliance Specifications	15
Table 15:	Reliability Specifications.....	16
Table 16:	Pin Definition for 2.5-inch Form Factor (8639 connector specification)	20
Table 17:	Pin Definition for Add-In Card (Half Height Half Length) Form Factor	22
Table 18:	SMART Attributes (Log Identifier 02h)	24
Table 19:	Additional SMART Attributes (Log Identifier CAh)	26
Table 20:	Temperature Statistics (Log Identifier C5h)	27
Table 21:	Drive Marketing Name Log (Log Identifier DDh).....	27
Table 22:	Set Max LBA Setting - Command Dword 11 and Command Dword 12	28
Table 23:	Status Code - Set Max LBA Command Specific Status Values.....	28
Table 24:	C6h - Set/ Get Power Governor Setting - Command Dword 11	28
Table 25:	Status Codes - Power Governor Setting Command Specific Status Values	28
Table 26:	D5h - Reset Timed Workload Counters - Command Dword 11.....	28
Table 27:	NVMe* Driver Support.....	29
Table 28:	Device Certifications and Declarations	30
Table 29:	Identify Controller.....	31
Table 30:	Power State Descriptor	34
Table 31:	Identify Namespace	35
Table 32:	LBA Format Data Structure	37
Table 33:	Vital Product Data Structure (VPD).....	38
Table 34:	Capability List Pointer (Out of Band Temperature Sensor)	38
Table 35:	Register 0x05 read out format.....	39
Table 36:	PCIe ID	40
Table 37:	LED Functionality	42

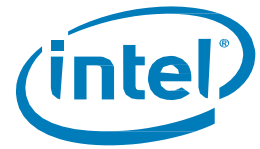

Revision History

Document Number	Revision Number	Description	Revision Date
330569	001	<ul style="list-style-type: none">• Initial release	June 2014
330569	002	<ul style="list-style-type: none">• Driver and temperature updates• Updated performance info	July 2014



This page intentionally left blank.

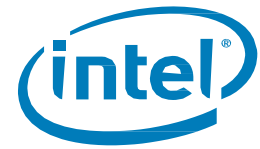

1 Overview

This document describes the specifications and capabilities of the Intel® Solid State Drive (SSD) DC P3600 Series.

P3600 Series is a PCIe* Gen3 SSD architected with the new high performance controller interface – NVMe* (Non-Volatile Memory express) delivering leading performance, low latency and Quality of Service. Matching the performance with world-class reliability and endurance, P3600 Series offers a range of capacity – 400GB, 800GB, 1.2TB, 1.6TB and 2TB in both Add-In card and 2.5-inch form factor.

With PCIe Gen3 support and NVMe* queuing interface, P3600 Series delivers excellent sequential read performance of up to 2.8GB/s and sequential write speeds of up to 1700MB/s. P3600 Series delivers very high random read IOPS of 450K and random write IOPS of 70K for 4KB operations. Taking advantage of the direct path from the storage to the CPU by means of NVMe*, P3600 Series exhibits low latency of less than 20 µs for sequential access to the SSD.

The 2.5-inch P3600 Series takes advantage of the 8639 connector and provides hot-pluggable removal and insertion providing in-service replacement options.

P3600 Series includes these key features:

- Consistently High IOPS and throughput
- Sustained low latency
- Variable Sector Size and End-to-End data-path protection
- Enhanced power-loss data protection
- Power loss protection capacitor self-test
- Out of band management
- Thermal throttling and monitoring



1.1 References

Table 1: Standard Information Referenced in this Document

Date	Title	Location
Jan 2013	Enterprise SSD Form Factor Version 1.0a	http://www.ssdformfactor.org
Feb 2012	NVMe* Revision 1.0c	http://www.nvmexpress.org
Nov 2010	PCIe* Base Specification Revision 3.0	http://pcisig.com
July 2012	Solid-State Drive (SSD) Requirements and Endurance Test Method (JESD219)	http://www.jedec.org/standards-documents/results/jesd219
Sept 2010	Solid-State Drive (SSD) Requirements and Endurance Test Method (JESD218)	http://www.jedec.org/standards-documents/docs/jesd218/
Dec 2008	VCCI	http://www.vcci.jp/vcci_e/
June 2009	RoHS	http://qdms.intel.com/ Click <i>Search MDDS Database</i> and search for material description datasheet
1995 1996 1995 1995 1997 1994	International Electrotechnical Commission EN 61000 4-2 (Electrostatic discharge immunity test) 4-3 (Radiated, radio-frequency, electromagnetic field immunity test) 4-4 (Electrical fast transient/burst immunity test) 4-5 (Surge immunity test) 4-6 (Immunity to conducted disturbances, induced by radio- frequency fields) 4-11 (Voltage Variations, voltage dips, short interruptions and voltage variations immunity tests)	http://www.iec.ch/
1995	ENV 50204 (Radiated electromagnetic field from digital radio telephones)	http://www.dbicorporation.com/radimmun.htm/



1.2 Terms and Acronyms

Table 2: Glossary of Terms and Acronyms

Term	Definition
ATA	Advanced Technology Attachment
CRC	Cyclic Redundancy Check
DAS	Device Activity Signal
DMA	Direct Memory Access
ECC	Error Correction Code
EEPROM	Electrically Erasable Programmable Read Only Memory
EXT	Extended
FPDMA	First Party Direct Memory Access
GB	Gigabyte Note: The total usable capacity of the SSD may be less than the total physical capacity because a small portion of the capacity is used for NAND flash management and maintenance purposes.
Gb	Gigabit
HDD	Hard Disk Drive
HET	High Endurance Technology
KB	Kilobyte
I/O	Input/Output
IOPS	Input/Output Operations Per Second
ISO	International Standards Organization
LBA	Logical Block Address
MB	Megabyte (1,000,000 bytes)
MLC	Multi-level Cell
MTBF	Mean Time Between Failures
NOP	No Operation
NVMe*	Non-Volatile Memory Express
PB	Petabyte
PCB	Printed Circuit Board
RDT	Reliability Demonstration Test
RMS	Root Mean Square
SSD	Solid-State Drive
TB	Terabyte
TYP	Typical
UBER	Uncorrectable Bit Error Rate
VPD	Vital Product Data



2 Product Specifications

2.1 Capacity

Table 3: User Addressable Sectors

Intel® SSD DC P3600 Series	Unformatted Capacity (Total User Addressable Sectors in LBA Mode)
400GB	390,721,968
800GB	781,422,768
1.2TB	1,562,824,368
1.6TB	3,125,627,568
2TB	3,907,029,168

NOTES:

1 GB = 1,000,000,000 bytes; 1 sector = 512 bytes or 520 bytes or 528 bytes.

LBA count shown represents total user storage capacity and will remain the same throughout the life of the drive. The total usable capacity of the SSD may be less than the total physical capacity because a small portion of the capacity is used for NAND media management and maintenance. IDEMA or JEDEC standard is used.

2.2 Performance

Table 4: Random Read/Write Input/Output Operations Per Second (IOPS)

Specification ¹	Unit	Intel® SSD DC P3600 Series				
		400GB	800GB	1.2TB	1.6TB	2TB
Random 4KB 70/30 Read/Write (up to) ²	IOPS	80,000	110,000	130,000	160,000	160,000
Random 8KB 70/30 Read/Write (up to) ²	IOPS	45,000	55,000	65,000	75,000	80,000
Random 4KB Read (up to)	IOPS	320,000	430,000	450,000	450,000	450,000
Random 4KB Write (up to)	IOPS	30,000	50,000	50,000	56,000	56,000
Random 8KB Read (up to)	IOPS	180,000	250,000	260,000	270,000	275,000
Random 8KB Write (up to)	IOPS	19,000	26,000	27,000	33,000	33,000

NOTES:

1. Performance measured using Iometer* on Intel® provided Windows Server 2012 R2 driver with Queue Depth 32 and number of workers equal to 4. Measurements are performed on a full Logical Block Address (LBA) span of the drive. Power mode set at 25W.
2. 4KB = 4,096 bytes
3. 8KB = 8,192 bytes

**Table 5: Random Read/Write IOPS Consistency**

Specification ¹	Unit	Intel® SSD DC P3600 Series				
		400GB	800GB	1.2TB	1.6TB	2TB
Random 4KB Read (up to) ²	%	90	90	90	90	90
Random 4KB Write (up to)	%	90	90	90	90	90
Random 8KB Read (up to) ³	%	90	90	90	90	90
Random 8KB Write (up to)	%	90	90	90	90	90

NOTES:

1. Performance consistency measured using Iometer* based on Random 4KB with total queue depth of 128, measured as (IOPS in the 99.9th percentile slowest 1-second interval)/(average IOPS during the test). Measurements are performed on a full Logical Block Address (LBA) span of the drive once the workload has reached steady state but including all background activities required for normal operation and data reliability
2. 4KB = 4,096 bytes
3. 8KB = 8,192 bytes

Table 6: Sequential Read and Write Bandwidth

Specification	Unit	Intel® SSD DC P3600 Series				
		400GB	800GB	1.2TB	1.6TB	2TB
Sequential Read (up to) ¹	MB/s	2,100	2,600	2,600	2,600	2,600
Sequential Write (up to) ¹	MB/s	550	1000	1250	1600	1700

NOTES:

1. Performance measured using Iometer* with 128 KB (131,072 bytes) of transfer size with Queue Depth 128. Power mode set at 25W.

Table 7: Latency

Specification	Intel® SSD DC P3600 Series	
	200, 400, 800 GB and 1.6TB, 2TB	
Latency ¹ (TYP) Read Sequential/Random Write Sequential/Random Power On to Ready ²	20/120 µs 20/30 µs 2.0 sec (TYP)	

NOTES:

1. Device measured using Iometer. Latency measured using 4 KB (4,096 bytes) transfer size with Queue Depth equal to 1 using Windows Server 2012 R2 driver. Power mode set at 25W.
2. Power On To Ready time measured from de-assertion of PCIe* reset to first interface response. Exception handling like unsafe power shutdown will not be part of this specification. For unsafe shutdown, the time to ready can be up to 10 seconds (TYP).



Table 8: Quality of Service

Specification	Unit	Intel® SSD DC P3600 Series	
		QD=1	QD=128
Quality of Service^{1,2} (99%)			
Reads	ms	0.600	2
Writes	ms	0.090	11
Quality of Service^{1,2} (99.99%)			
Reads	ms	4	5
Writes	ms	2	35 (400GB) 30 (800GB, 1.2TB, 1.6TB, 2.0TB)

NOTES:

1. Device measured using Iometer. Quality of Service measured using 4KB (4,096 bytes) transfer size on a random workload on a full Logical Block Address (LBA) span of the drive once the workload has reached steady state but including all background activities required for normal operation and data reliability.
2. Based on Random 4KB QD=1,128 workloads, measured as the time taken for 99.0(or 99.99) percentile of commands to finish the round-trip from host to drive and back to host.

2.3 Electrical Characteristics

Table 9: Operating Voltage

Electrical Characteristics	Intel® SSD DC P3600 Series
3.3V Operating Characteristics: (Add-in Card only) Operating Voltage range Rise time (Max/Min) Fall time (Max/Min) ¹ Noise level Min Off time ² Inrush Current (Typical Peak) ³ Max Average Current	3.3 V (±10%) 50ms/1ms 5s/1ms 300 mV pp 10Hz – 100 KHz 50 mV pp 100KHz – 20 MHz 3 seconds 1.5 A 3.0 A
12V Operating Characteristics: Operating Voltage range Rise time (Max/Min) Fall time (Max/Min) ¹ Noise level Min Off time ² Inrush Current (Typical Peak) ³ Max Average Current	12 V (+10%/-20%) 50ms/1ms 5s/1ms 1000 mV pp 10Hz – 100 KHz 100 mV pp 100KHz – 20 MHz 3 seconds 1.5 A 2.1 A/ 2.45 A (Add-in Card/2.5" FF)

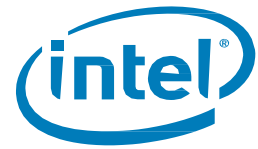

Electrical Characteristics	Intel® SSD DC P3600 Series
3.3Vaux Operating Characteristics: Operating Voltage range Rise time (Max/Min) Fall time (Max/Min) ¹ Noise level Max Current	3.3V (±9%) 50ms/1ms 5s/1ms 300 mV pp 10Hz – 100 KHz 50 mV pp 100KHz – 20 MHz 20mA/1mA (AIC/2.5" FF)

Notes:

1. Fall time needs to be equal or better than minimum in order to guarantee full functionality of enhanced power loss management.
2. The drive must be powered off for at least 500msec before powering on.
3. Measured during initial power supply application. Typically this will be seen within 2 seconds of initial power up. Inrush specified for 12V and 3.3V supply, not the 3.3Vaux.

Note: 3.3Vaux is optional, not needed for power up or functionality. 3.3Vaux is needed for accessing VPD page by means of SMBUS for both form factors.

Table 10: Power Consumption

Specification	Unit	Intel® SSD DC P3600 Series				
		400GB	800GB	1.2TB	1.6TB	2TB
Active Write - Average ¹	W	12	18	22	22	25
Active Read - Average ²	W	9	9	10	10	11
Idle	W	4	4	4	4	4

Notes:

1. The workload equates 128KB (131,072 bytes) Queue Depth equal to 128 sequential writes. Average power is measured using scope trigger over a 100 ms sample period
2. The workload equates 128KB (131,072 bytes) Queue Depth equal to 128 sequential reads.

2.4 Environmental Conditions

Table 11: Temperature, Shock, Vibration

Temperature	Add-In Card form factor	2.5-inch form factor
Temperature Operating ¹ Non-operating ³	Ambient 0 – 55° C / 0 –40° C ² -55–95° C	Ambient 0–35° C, Case: 0-70 ° C
Temperature Gradient ⁴ Operating Non-operating	30° C/hr (Typical) 30° C/hr (Typical)	30° C/hr (Typical) 30° C/hr (Typical)
Humidity Operating Non-operating	5–95% 5–95%	5–95% 5–95%



Shock and Vibration	Range	
Shock ⁵ Operating Non-operating	50 G Trapezoidal, 170 in/s 50 G Trapezoidal, 170 in/s	1,000 G (Max) at 0.5 msec 1,000 G (Max) at 0.5 msec
Vibration ⁶ Operating Non-operating	2.17 GRMS (5-700 Hz) Max 3.13 G _{RMS} (5-800 Hz) Max	2.17 GRMS (5-700 Hz) Max 3.13 G _{RMS} (5-800 Hz) Max

Notes:

1. Operating temperature implies ambient air temperature under defined airflow in Tables 12 and 13
2. 0-55 °C is for airflow from the server towards the card and 0-40 °C is for airflow into the server
3. Please contact your Intel representative for details on the non-operating temperature range
4. Temperature gradient measured without condensation
5. Shock specifications assume the SSD is mounted securely with the input vibration applied to the drive-mounting screws. Stimulus may be applied in the X, Y or Z axis. Shock specification is measured using Root Mean Squared (RMS) value
6. Vibration specifications assume the SSD is mounted securely with the input vibration applied to the drive-mounting screws. Stimulus may be applied in the X, Y or Z axis. Vibration specification is measured using RMS value

Table 12: Airflow Requirements for Intel® SSD DC P3600 Series (Add-In Card)

Airflow Direction	Unit	Ambient Temperature	Intel® SSD DC P3600 Series				
			400GB	800GB	1.2TB	1.6TB	2TB
Towards the server	LFM	40 °C	100	300	300	300	300
Out of the server	LFM	55 °C	100	300	300	300	300

NOTE: For Add-In cards airflow can be for both the directions. Airflow specified is based on approach velocity.

Table 13: Airflow Requirements for Intel® SSD DC P3600 Series (2.5-inch Form Factor)

Airflow Definition	Unit	Ambient Temperature	Intel® SSD DC P3600 Series				
			400GB	800GB	1.2TB	1.6TB	2TB
Airflow Along Drive ¹	LFM	35 °C	300	500	650	650	650
	LFM	25 °C	250	350	450	450	450
Approach Airflow ²	LFM	35 °C	70	120	155	155	155
	LFM	25 °C	60	85	110	110	110

NOTE:

1. It is recommended that airflow for 2.5-inch form factor should be towards the server, from the non-connector side to the connector side. Airflow is specified across the surface of the drive. Spacing between two SSDs is assumed to be 3mm.
2. The approach velocity of the airflow will be less than the airflow along the surface. Approach area of 1.35 ft² is assumed.

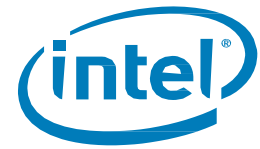

2.5 Product Regulatory Compliance

Intel® SSD DC P3600 Series meets or exceeds the regulatory or certification requirements in Table 14.

Table 14: Product Regulatory Compliance Specifications

Title	Description	Region For Which Conformity Declared
TITLE 47-Telecommunications CHAPTER 1 – FEDERAL COMMUNICATIONS COMMISSION PART 15 – RADIO FREQUENCY DEVICES ICES-003, Issue 4 Interference-Causing Equipment Standard Digital Apparatus	FCC Part 15B Class A CA/CSA-CEI/IEC CISPR 22:10. This is CISPR 22:2008 with Canadian Modifications	USA Canada
IEC 55024 Information Technology Equipment – Immunity characteristics – Limits and methods of measurement CISPR24:2010	EN-55024: 2010 and its amendments	European Union
IEC 55022 Information Technology Equipment – Radio disturbance Characteristics – Limits and methods of measurement CISPR24:2008 (Modified)	EN-55022: 2010 and its amendments	European Union
EN-60950-1 2 nd Edition	Information Technology Equipment – Safety – Part 1: General Requirements	USA/Canada
UL/CSA EN-60950-1 2 nd Edition	Information Technology Equipment – Safety – Part 1: General Requirements	USA/Canada



2.6 Reliability Specifications

Intel® SSD DC P3600 Series meets or exceeds SSD endurance and data retention requirements as specified in the JESD218 standard. Reliability specifications are listed in Table 15.

Table 15: Reliability Specifications

Parameter	Value
Uncorrectable Bit Error Rate (UBER) Uncorrectable bit error rate will not exceed one sector in the specified number of bits read. In the unlikely event of a non-recoverable read error, the SSD will report it as a read failure to the host; the sector in error is considered corrupt and is not returned to the host.	< 1 sector per 10 ¹⁷ bits read
Mean Time Between Failures (MTBF) Mean Time Between Failures is estimated based on Telcordia* methodology and demonstrated through Reliability Demonstration Test (RDT).	2 million hours
Data Retention The time period for retaining data in the NAND at maximum rated endurance.	3 months power-off retention once SSD reaches rated write endurance at 40 °C
Endurance Rating The number of drive writes such that the SSD meets the requirements according to the JESD218 standard. Endurance rating verification is defined to establish UBER <1E-16 at 60% upper confidence limit.	400GB: 2.19 PBW 800GB: 4.38 PBW 1.2TB: 6.57 1.6TB: 8.76 PBW 2.0TB: 10.95 PBW (3 drive writes/day*)

Note: Petabytes Written (PBW). Refer to JESD218 standard table 1 for UBER, FFR and other Enterprise SSD requirements.

2.7 Temperature Sensor

P3600 Series has an internal temperature sensor with an accuracy of +/-2C over a range of -10C to +85C which can be monitored using NVMe* Health Log.

For more information on sensor reading see SMART attributes section. In addition, drive will provide out of band access to temperature by means of SMBUS. The sensor has an accuracy of +/- 3C over a range of -20C to 125C. SMBUS temperature sensor will not be reported in NVMe* Health Log.

2.8 Power Loss Capacitor Test

P3600 Series supports testing of the power loss capacitor, which can be monitored using SMART attribute critical warning in log page identifier 02h, byte 0, bit 4.



2.9 Hot Plug Support

2.5-inch form factor will support surprise hot plug feature in capable platforms and OSs. Intel SSD DC P3600 Series supports hot insertion and removal and surprise hot insertion by means of presence detect and link-up detect. On surprise hot removal during IOs, P3600 Series will enable the integrity of already committed data on the media and commit acknowledged writes to the media.

2.10 Out of Band Management (SMBUS)

P3600 Series provides out of band management by means of SMBUS interface. This requires 3.3V Auxiliary voltage. SMBUS accesses a VPD page as listed in Appendix B through address 0X53.

Temperature sensor is accessed through address 0x1B. For temperature sensor access, temperature can be read by the BMC (base) using Read Temperature Data Register (0x05) by means of SMBUS 0x1B. Bits [11:0] return raw ambient temperature.

Host may also see 0x66 address in a bus scan. This is only used for write protecting the EEPROM during manufacturing.

Note: In certain tools address for the VPD and temperature sensor will appear as 0xA6 and 0x36 respectively due to bit shift.

2.11 Variable Sector Size Support

P3600 Series supports 512, 520, 528, 4096, 4104, 4160 and 4224 bytes of sector size. P3600 Series will also support DIF as specified in NVMe* 1.0 specification. 520 and 4104 Byte sector sizes can support PI (protection information) which is 8 Byte long.

In terms of protection information action (PRACT), bit 29 of DWORD12 in READ/Write command should not be equal to 1. Device only supports PRACT=0, implying protection information is passed to the SSD and checked by the SSD.

3 Mechanical Information

Figures 3-1 and 3-2 show the physical package information for the Intel® SSD DC P3600 Series in the 2.5-inch form factors. All dimensions are in millimeters.

Figure 3-1 Intel® SSD DC P3600 Series SFF Dimensions

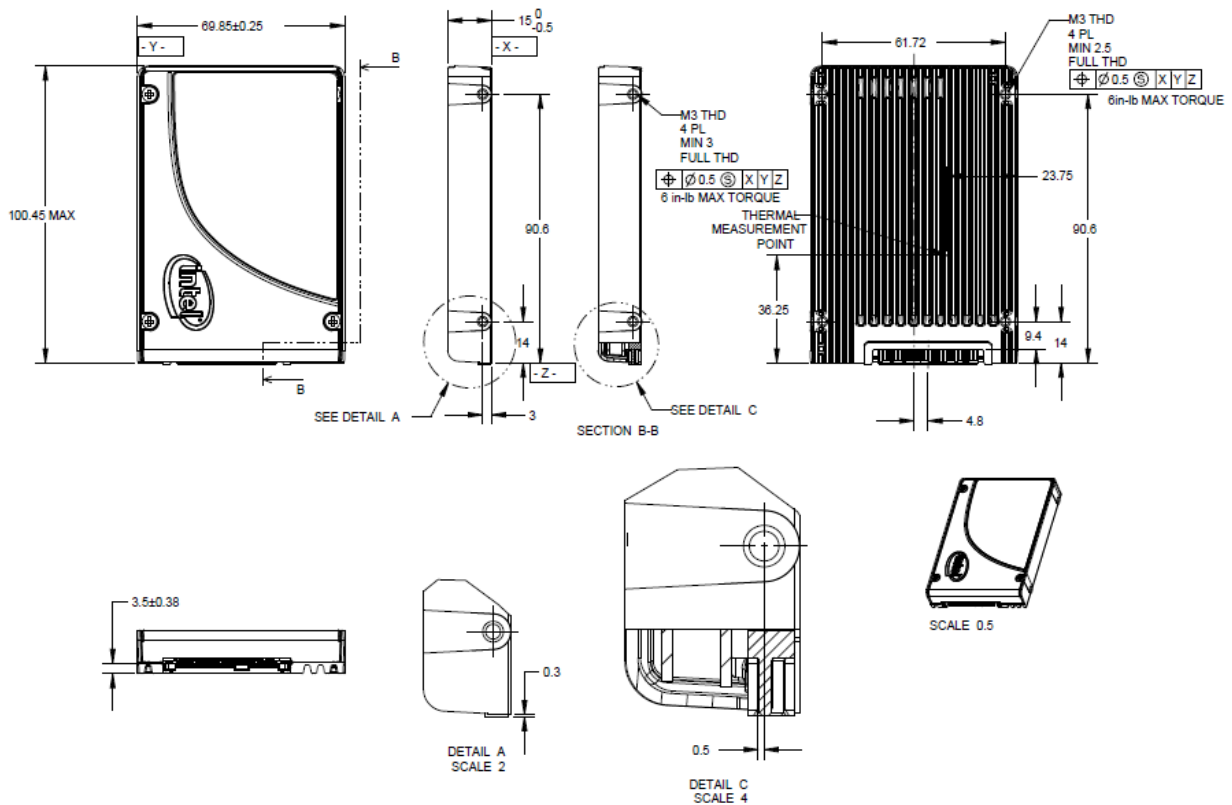

X – Length	Y – Width	Z – Height
100.45 Max	69.85 +/- 0.25	15.0 +0/-0.5

Note: Length does not include 0.3 connector protrusion

Figure 3-2 Intel® SSD DC P3600 Series PCIe* Dimensions

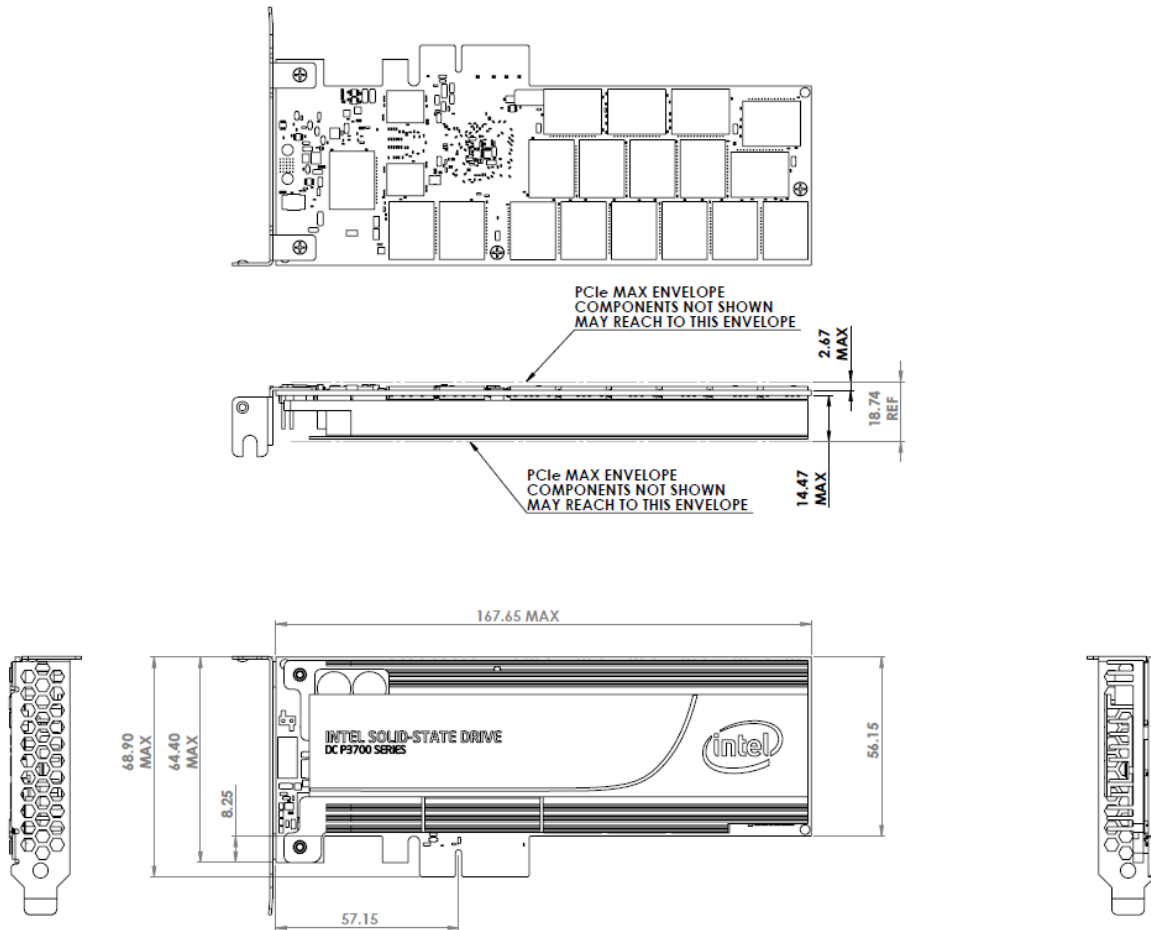

§

4 Pin and Signal Descriptions

4.1 2.5-inch Form Factor Pin Locations

Figure 4-1 2.5-inch Form Factor Pin Locations

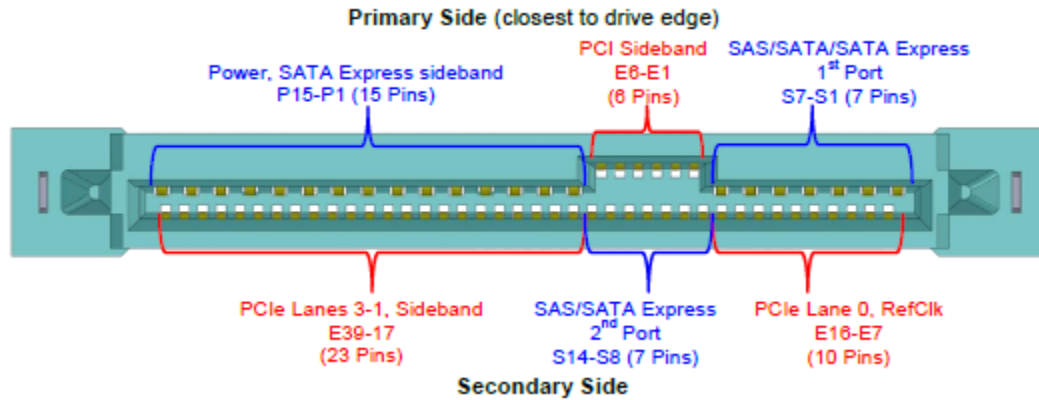

Note: 2.5-inch connector supports built in latching capability.

4.2 Pin Signal Definitions

Table 16: Pin Definition for 2.5-inch Form Factor (8639 connector specification)

Pin	Name	Description	Pin	Name	Description
S1	GND	Ground	E7	REFCLK0+	Reference clock port 0
S2		Not used (SATA/SAS)	E8	REFCLK0-	Reference clock port 0
S3		Not used (SATA/SAS)	E9	GND	Ground
S4	GND	Ground	E10	PETp0	Transmitter differential pair, Lane 0
S5		Not used (SATA/SAS)	E11	PETn0	Transmitter differential pair, Lane 0
S6		Not used (SATA/SAS)	E12	GND	Ground
S7	GND	Ground	E13	PERn0	Receiver differential pair, Lane 0
E1	REFCLK1+	Reference clock port 1 (not used)	E14	PERp0	Receiver differential pair, Lane 0
E2	REFCLK1-	Reference clock port 1 (not used)	E15	GND	Ground
E3	3.3Vaux	3.3V auxiliary power	E16	RSVD	Reserved
E4	PERST1#	Fundamental reset port 1 (not used)	S8	GND	Ground
E5	PERST0#	Fundamental reset port 0	S9		Not used (SATAe/SAS)
E6	RSVD	Reserved	S10		Not used (SATAe/SAS)

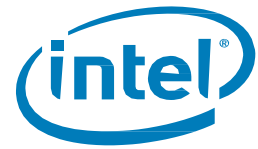

Intel® Solid-State Drive DC P3600 Series

Pin	Name	Description	Pin	Name	Description
P1		Not used (SATAe/SAS)	S11	GND	Ground
P2		Not used (SATAe/SAS)	S12		Not used (SATAe/SAS)
P3		Not used (SATAe)	S13		Not used (SATAe/SAS)
P4	IfDet_N	Interface detect (drive type)	S14	GND	Ground
P5	GND	Ground	S15	RSVD	Reserved
P6	GND	Ground	S16	GND	Ground
P7		Not used (SATA/SAS)	S17	PETp1	Transmitter differential pair, Lane 1
P8		Not used (SATA/SAS)	S18	PETn1	Transmitter differential pair, Lane 1
P9		Not used (SATA/SAS)	S19	GND	Ground
P10	PRSNT_N	Presence detect (also used for drive type)	S20	PERn1	Receiver differential pair, Lane 1
P11	Activity	Activity signal from the drive	S21	PERp1	Receiver differential pair, Lane 1
P12	Hot-Plug	Ground	S22	GND	Ground
P13	+12V_pre	12V power	S23	PETp2	Transmitter differential pair, Lane 2
P14	+12V	12V power	S24	PETn2	Transmitter differential pair, Lane 2
P15	+12V	12V power	S25	GND	Ground
			S26	PERn2	Receiver differential pair, Lane 2
			S27	PERp2	Receiver differential pair, Lane 2
			S28	GND	Ground
			E17	PETp3	Transmitter differential pair, Lane 3
			E18	PETn3	Transmitter differential pair, Lane 3
			E19	GND	Ground
			E20	PERn3	Receiver differential pair, Lane 3
			E21	PERp3	Receiver differential pair, Lane 3
			E22	GND	Ground
			E23	SMCLK	SMBus clock
			E24	SMDAT	SMBus data
			E25	DualPortEn_N	Dual port enable

NOTES:

- SMCLK and SMDAT routes to an internal EEPROM which contains Vital Product Data (VPD).
- PRSNT_N is kept open by the P3600 Series.
- IfDet_N is grounded by the P3600 Series.
- DualPortEn_N pin should be left un-connected or un-driven by the system to enable single port operation with all 4 lanes. If un-connected, P3600 will pull it high. However, if the pin is asserted by the system (driven low by storage backplane), then P3600 will be configured as x2 lanes.
- P11 is used for activity. When idle, logic level is low (LED Solid On). During IO activity and formatting, pin toggles 250msec high, 250msec low signal.
- P3600 Series only uses REFCLK0+ and REFCLK0- as reference clock pair.
- P3600 Series only uses PERST0# as a fundamental reset.
- 3.3Vaux is only needed during SMBUS access to the VPDROM.

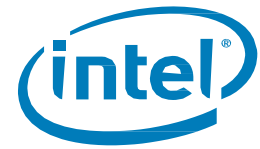

Table 17: Pin Definition for Add-In Card (Half Height Half Length) Form Factor

Side B			Side A	
Pin	Name	Description	Name	Description
1	+12V	12V power	PRSNT1#	Hot-Plug presence detect
2	+12V	12V power	+12V	12V power
3	+12V	12V power	+12V	12V power
4	GND	Ground	GND	Ground
5	SMCLK	SMBus(System Management Bus) clock	JTAG2	TCK (Test Clock), clock input for JTAG interface
6	SMDAT	SMBus (System Management Bus) data	JTAG3	TDI (Test Data Input)
7	GND	Ground / UART_HOST	JTAG4	TDO (Test Data Output)
8	+3.3V	3.3V power	JTAG5	TMS (Test Mode Select)
9	JTAG1	TRST# (Test Reset) resets the JTAG interface	+3.3V	3.3V power
10	3.3Vaux	3.3V auxiliary power	+3.3V	3.3V power
11	WAKE#	Signal for Link reactivation	PERST#	Fundamental reset
Mechanical Key				
12	RSVD	Reserved	GND	Ground
13	GND	Ground	REFCLK+	Reference clock (differential pair)
14	PETp0	Transmitter differential pair, Lane 0	REFCLK-	Reference clock (differential pair)
15	PETn0	Transmitter differential pair, Lane 0	GND	Ground
16	GND	Ground	PERp0	Receiver differential pair, Lane 0
17	PRSNT2#	Hot-Plug presence detect	PERn0	Receiver differential pair, Lane 0
18	GND	Ground	GND	Ground
End of the x1 Connector				
19	PETp1	Transmitter differential pair, Lane 1	RSVD	Reserved
20	PETn1	Transmitter differential pair, Lane 1	GND	Ground
21	GND	Ground	PERp1	Receiver differential pair, Lane 1
22	GND	Ground	PERn1	Receiver differential pair, Lane 1
23	PETp2	Transmitter differential pair, Lane 2	GND	Ground
24	PETn2	Transmitter differential pair, Lane 2	GND	Ground
25	GND	Ground	PERp2	Receiver differential pair, Lane 2
26	GND	Ground	PERn2	Receiver differential pair, Lane 2
27	PETp3	Transmitter differential pair, Lane 3	GND	Ground
28	PETn3	Transmitter differential pair, Lane 3	GND	Ground
29	GND	Ground	PERp3	Receiver differential pair, Lane 3
30	RSVD	Reserved	PERn3	Receiver differential pair, Lane 3
31	PRSNT2#	Hot-Plug presence detect	GND	Ground
32	GND	Ground	RSVD	Reserved
End of the x4 Connector				

NOTES:

- All pins are numbered in ascending order from the left to the right, with side A on the top of the centerline and side B on the bottom of the centerline, use the reference drawing in Fig2, with the logo visible.
- The PCI Express interface pins PETpx, PETnx, PERpx, and PERnx are named with the following convention: "PE" stands for PCI Express high speed, "T" for Transmitter, "R" for Receiver, "p" for positive (+) and "n" for negative (-).
- The sequential mating for Hot-Plug is accomplished by staggering the edge fingers on the add-in card.



5 Supported Command Sets

Intel® SSD DC P3600 Series supports all mandatory Admin and I/O commands defined in NVMe* (Non-Volatile Memory Express) revision 1.0.

5.1 NVMe* Admin Command Set

P3600 Series supports all mandatory NVMe* commands, which are:

- Delete I/O Submission Queue
- Delete I/O Completion Queue
- Create I/O Submission Queue
- Create I/O Completion Queue
- Get Log Page
- Identify
- Abort
- SET Features
- GET Features
- Asynchronous Event Notification

P3600 Series also supports the following optional I/O commands defined in NVMe* revision 1.0:

- Firmware Activate
- Firmware Image Download
- Format NVM*

Note: See Appendix A, "Identify Controller Data Structure" for details on commands and capabilities.

5.2 NVMe* I/O Command Set

P3600 Series supports all the mandatory NVMe* I/O command set defined in NVMe* 1.0 specification, which are:

- Flush
- Write
- Read

Additionally, the following optional commands are supported:

- Write Uncorrectable
- Dataset Management (De-allocate only)



5.3 Log Page Support

Intel® SSD DC P3600 Series supports the following mandatory log pages defined in NVMe* 1.0 specification:

- Error Information (Log Identifier 01h)
- SMART/ Health Information (Log Identifier 02h)
- Firmware Slot Information (Log Identifier 03h)

Note: See NVMe* 1.0 version of the specification for the log page content. Additionally, P3600 Series will support the following vendor unique log pages:

- Log Page Directory (Log Identifier C0h)
- Temperature Statistics (Log Identifier C5h)
- Vendor Unique SMART Log (Log Identifier CAh)
- Drive Marketing Name Log (Log Identifier DDh)
-

5.4 SMART Attributes

Table 18 lists the SMART attributes supported by the P3600 Series in accordance with NVMe* 1.0 specification.

Table 18: SMART Attributes (Log Identifier 02h)

Byte	# of Bytes	Attribute	Description
0	1	Critical Warning: These bits if set, flag various warning sources. Bit 0: Available Spare is below Threshold Bit 1: Temperature has exceeded Threshold Bit 2: Reliability is degraded due to excessive media or internal errors Bit 3: Media is placed in Read- Only Mode Bit 4: Volatile Memory Backup System has failed (e.g., enhanced power loss capacitor test failure) Bits 5-7: Reserved	Any of the critical warning can be tied to asynchronous event notification.
1	2	Temperature: Overall Device current temperature in Kelvin.	For AIC, it reports the NAND temperature, for 2.5-inch FF, it is the case temperature.
3	1	Available Spare: Contains a normalized percentage (0 to 100%) of the remaining spare capacity available	Starts from 100 and decrements.
4	1	Available Spare Threshold	Threshold is set to 10%.
5	1	Percentage Used Estimate (Value allowed to exceed 100%)	A value of 100 indicates that the estimated endurance of the device has been consumed, but may not indicate a device failure. The value is allowed to exceed 100. Percentages greater than 254 shall be represented as 255. This value shall be updated once per power-on hour (when the controller is not in a sleep state).



Byte	# of Bytes	Attribute	Description
32	16	Data Units Read (in LBAs)	Contains the number of 512 byte data units the host has read from the controller; this value does not include metadata. This value is reported in thousands (i.e., a value of 1 corresponds to 1000 units of 512 bytes read) and is rounded up. When the LBA size is a value other than 512 bytes, the controller shall convert the amount of data read to 512 byte units.
48	16	Data Units Write (in LBAs)	Contains the number of 512 byte data units the host has written to the controller; this value does not include metadata. This value is reported in thousands (i.e., a value of 1 corresponds to 1000 units of 512 bytes written) and is rounded up. When the LBA size is a value other than 512 bytes, the controller shall convert the amount of data written to 512 byte units. For the NVM command set, logical blocks written as part of Write operations shall be included in this value. Write Uncorrectable commands shall not impact this value.
64	16	Host Read Commands	Contains the number of read commands issued to the controller.
80	16	Host Write Commands	Contains the number of write commands issued to the controller.
96	16	Controller Busy Time (in minutes)	Contains the amount of time the controller is busy with I/O commands. The controller is busy when there is a command outstanding to an I/O Queue (specifically, a command was issued by way of an I/O Submission Queue Tail doorbell write and the corresponding completion queue entry has not been posted yet to the associated I/O Completion Queue). This value is reported in minutes.
112	16	Power Cycles	Contains the number of power cycles.
128	16	Power On Hours	Contains the number of power-on hours. This does not include time that the controller was powered and in a low power state condition.
144	16	Unsafe shutdowns	Contains the number of unsafe shutdowns. This count is incremented when a shutdown notification (CC.SHN) is not received prior to loss of power.
160	16	Media Errors	Contains the number of occurrences where the controller detected an unrecovered data integrity error. Errors such as uncorrectable ECC, CRC checksum failure, or LBA tag mismatch are included in this field.
176	16	Number of Error Information Log Entries	Contains the number of Error Information log entries over the life of the controller.



Table 19: Additional SMART Attributes (Log Identifier CAh)

Byte	# of Bytes	Attribute	Description
0	1	AB (Program Fail Count)	Raw value: shows total count of program fails. Normalized value: beginning at 100, shows the percent remaining of allowable program fails.
3	1	Normalized Value	
5	6	Current Raw Value	
12	1	AC (Erase Fail Count)	Raw value: shows total count of erase fails. Normalized value: beginning at 100, shows the percent remaining of allowable erase fails.
15	1	Normalized Value	
17	6	Current Raw Value	
24	1	AD (Wear Leveling Count)	Raw value: Bytes 1-0: Min. erase cycle Bytes 3-2: Max. erase cycle Bytes 5-4: Avg. erase cycles Normalized value: decrements from 100 to 0.
27	1	Normalized Value	
29	6	Current Raw Value	
36	1	B8 (End to End Error Detection Count)	Raw value: reports number of End-to-End detected and corrected errors by hardware. Normalized value: always 100.
39	1	Normalized Value	
41	6	Current Raw Value	
48	1	C7 (CRC Error Count)	Raw value: shows total number of encountered SATA interface cyclic redundancy check (CRC) errors. Normalized value: always 100.
51	1	Normalized Value	
53	6	Current Raw Value	
60	1	E2 (Timed Workload, Media Wear)	Raw value: measures the wear seen by the SSD (since reset of the workload timer, attribute E4h), as a percentage of the maximum rated cycles. Divide the raw value by 1024 to derive the percentage with 3 decimal points. Normalized value: always 100.
63	1	Normalized Value	
65	6	Current Raw Value	
72	1	E3 (Timed Workload, Host Reads %)	Raw value: shows the percentage of I/O operations that are read operations (since reset of the workload timer, attribute E4h). Reported as integer percentage from 0 to 100. Normalized value: always 100.
75	1	Normalized Value	
77	6	Current Raw Value	
84	1	E4 (Timed Workload, Timer)	Raw value: measures the elapsed time (number of minutes since starting this workload timer). Normalized value: always 100.
87	1	Normalized Value	
89	6	Current Raw Value	
96	1	EA (Thermal Throttle Status)	Raw value: reports Percent Throttle Status and Count of events Byte 0: Throttle status reported as integer percentage. Bytes 1-4: Throttling event count. Number of times thermal throttle has activated. Preserved over power cycles. Byte 5: Reserved. Normalized value: always 100.
99	1	Normalized Value	
101	6	Current Raw Value	

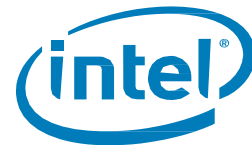

5.5 Temperature Statistics

Table 20: Temperature Statistics (Log Identifier C5h)

Byte	# of Bytes	Description
0	1	Current Temperature
24	8	Highest temperature
32	8	Lowest temperature
80	8	Specified Maximum Operating Temperature
96	8	Specified Minimum Operating Temperature
104	8	Estimated Offset

Note: For 2.5-inch form factor, case temperature is reported.
For Add-in Card, NAND temperature is reported.

5.6 Drive Marketing Name Log

Table 21: Drive Marketing Name Log (Log Identifier DDh)

Byte	# of Bytes	Log Page Content
0	8	Intel®
8	1	Space
9	3	SSD
12	1	Space
13	2	DC
15	1	Space
16	5	P3600
21	1	Space
22	6	Series
28-511	484	Reserved

5.7 SET Feature Identifiers

In addition to the SMART attribute structure, features pertaining to the operation and health of the Intel® SSD DC P3600 Series can be reported to the host on request through the Get Features command. P3600 Series can change settings using SET Features on the following items as defined in NVMe* 1.0 specification.

- Arbitration (Feature Identifier 01h)
- Power Management (Feature Identifier 02h)
- Temperature Threshold (Feature Identifier 04h)
- Error Recovery (Feature Identifier 05h)
- Volatile Write Cache (Feature Identifier 06h)
- Number of Queues (Feature Identifier 07h)
- Interrupt Coalescing (Feature Identifier 08h)
- Interrupt Vector Configuration (Feature Identifier 09h)
- Write Atomicity (Feature Identifier 0Ah)
- Asynchronous Event Configuration (Feature Identifier 0Bh)



Intel® SSD DC P3600 Series will also support the following vendor unique SET Features.

- Set/Get Max LBA (Feature Identifier C1h)
- Set/Get Native Max LBA (Feature Identifier C2h)
- Power Governor Setting (Feature Identifier C6h)
- Reset Timed Workload Counters (Feature Identifier D5h)

Table 22: Set Max LBA Setting - Command Dword 11 and Command Dword 12

Bit	Description
63:00	Maximum User LBA: Write Usage: This field sets the 64-bit maximum LBA addressable by the Drive. Read Usage: This field contains the 64-bit maximum LBA addressable by the Drive. Command Dword 11 contains bits 31:00; Command Dword 12 contains bits 63:32.

Table 23: Status Code - Set Max LBA Command Specific Status Values

Value	Description
C0h	Requested MAX LBA exceeds Available capacity
C1h	Requested MAX LBA smaller than minimum allowable limit.
C2h	Requested MAX LBA is smaller than allocated Namespace requirements

Table 24: C6h - Set/ Get Power Governor Setting – Command Dword 11

Bit	Description
31:08	Reserved (TBD)
07:00	Power Governor Setting: 00h = 25W, 01h = 20W, 02h = 15W

Table 25: Status Codes - Power Governor Setting Command Specific Status Values

Value	Description
C0h	Invalid Setting

Table 26: D5h – Reset Timed Workload Counters – Command Dword 11

Bit	Description
31:01	Reserved
00	Timed Workload Reset Settings: Write Usage: 00 = NOP, 1 = Reset E2, E3,E4 counters; Read Usage: Not Supported

Note: Get Features will not work for “Reset Timed Workload Counters” and status code is same as Table 25.

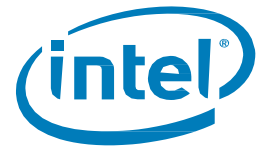

6 NVMe* Driver Support

Table 27 describes the NVMe* Driver Support for Intel® SSD DC P3600 Series. The support includes releasing and validating NVMe* drivers for certain operating systems and validating functionality for open source drive, inbox or native drivers for select operating systems.

Table 27: NVMe* Driver Support

Support Level	Operating System Description
Intel Provided ¹	Windows* Server 2012 R2, 2012, 2008 R2 x64
In-box Driver ²	RHEL 6.5, RHEL 7.0, Windows* Server 2012 R2

NOTES:

1. With Intel provided driver, full product specification is provided
2. With open source non-Intel driver, compatibility and functionality is validated



7 Certifications and Declarations

Table 28: Device Certifications and Declarations

Certification	Description
CE Compliant	European Economic Area (EEA): Compliance with the essential requirements of EC Council Directives Low Voltage Directive (LVD) 2006/95/EC, EMC Directive 2004/108/EC and Directive 2011/65/EU.
UL Recognized	Certified Underwriters Laboratories, Inc. Bi-National Component Recognition; UL 60950-1, 2nd Edition, 2007-03-27 (Information Technology Equipment - Safety - Part 1: General Requirements) CSA C22.2 No. 60950-1-07, 2nd Edition, 2007-03 (Information Technology Equipment - Safety - Part 1: General Requirements)
C-Tick Compliant	Compliance with the Australia/New Zealand Standard AS/NZS3548 and Electromagnetic Compatibility (EMC) Framework requirements of the Australian Communication Authority (ACA).
BSMI Compliant	Compliance to the Taiwan EMC standard CNS 13438: Information technology equipment - Radio disturbance Characteristics - limits and methods of measurement, as amended on June 1, 2006, is harmonized with CISPR 22: 2005.04.
KCC	Compliance with paragraph 1 of Article 11 of the Electromagnetic Compatibility Control Regulation and meets the Electromagnetic Compatibility (EMC) Framework requirements of the Radio Research Laboratory (RRL) Ministry of Information and Communication Republic of Korea.
VCCI	Voluntary Control Council for Interface to cope with disturbance problems caused by personal computers or facsimile.
Microsoft WHCK	Microsoft Windows Hardware Certification Kit
RoHS Compliant	Restriction of Hazardous Substance Directive
WEEE	Directive on Waste Electrical and Electronic Equipment



Appendix A IDENTIFY Data Structure

Table 29: Identify Controller

Bytes	F = Fixed V = Variable X = Both	Default Value	Interpretation	Description
1-0	F	8086h	Contains the company vendor identifier that is assigned by the PCI SIG	PCI Vendor ID (VID)
3-2	F	8086h	Contains the company vendor identifier that is assigned by the PCI SIG for subsystem	PCI Subsystem Vendor ID (SSVID)
23-4	V	varies	Contains the serial number for the NVM subsystem	Serial Number (SN)
63-24	V	varies	Contains the serial number for the NVM subsystem that is assigned by the vendor as an ASCII string	Model Number (MN)
71-64	V	varies	Contains the currently active firmware revision for the NVM subsystem	Firmware Revision (FR)
72	F	0h	Recommended Arbitration Burst size equals 1	Recommended Arbitration Burst (RAB)
75-73	F	5CD2E4h	Contains the Organization Unique Identifier (OUI) for the controller vendor	IEEE OUI Identifier (IEEE)
76	X	0h	No of multiple PCI Express interfaces connected to the host, bit 0 determines multiple interface	Multi-Interface Capabilities (MIC)
77	F	05h	Supports MDTs of 128K	Maximum Data Transfer Size (MDTS)
255:78				Reserved
257-256	F	07h	Supports Security Send/Receive, Format NVM and Firmware Activate/Download	Optional Admin Command Support (OACS)
258	F	03h	Supports up to 3 concurrently outstanding abort commands	Abort Command Limit (ACL)
259	F	03h	Supports up to 3 concurrently outstanding asynchronous event requests	Asynchronous Event Request Limit (AERL)
260	X	03h	Single slot Read/write capable	Firmware Updates (FRMW)
261	X	0h	SMART/Health Log Support per drive not per namespace	Log Page Attributes (LPA)
262	F	3Fh	Number of Error Information log entries equals 64	Error Log Page Entries (ELPE)
263	F	0h	Number of NVM Express* power states equal 1	Number of Power States Support (NPSS)
264	F	0h	Configuration settings for Admin Vendor Specific command handling	Admin Vendor Specific Command Configuration (AVSCC)
511-265				Reserved
512	F	66h	Required and max submission queue entry size is 64 Byte	Submission Queue Entry Size (SQES)
513	F	44h	Required and max submission queue entry size is 16 Byte	Completion Queue Entry Size (CQES)
515-514				Reserved
519-516	F	01h	Supports single namespace	Number of Namespaces (NN)
521-520	F	06h	Supports Dataset Management	Optional NVMe* Command Support



Bytes	F = Fixed V = Variable X = Both	Default Value	Interpretation	Description
			and Write Uncorrectable optional NVMe* commands.	(ONCS)
523-522	F	0h	Fused commands not supported	Fused Operation Support (FUSES)
524	F	07h	Supports Crypto Erase and format of entire drive, not per namespace	Format NVM Attributes (FNA):
525	F	0h	Volatile write cache is not present	Volatile Write Cache (VWC)
527-526	F	0h	Atomic write size for controller during normal equals to 512B	Atomic Write Unit Normal (AWUN)
529-528	F	0h	Indicates the atomic write size for the controller during a power fail condition equals 512B	Atomic Write Unit Power Fail (AWUPF)
530	X	0h	Not Supported	NVM Vendor Specific Command Configuration (NVSCC)
703-531				Reserved
2047-704				Reserved
2079-2048	V		Indicates the characteristics of power state 0	Power State 0 Descriptor (PSD0)
2111-2080	V		Indicates the characteristics of power state 1	Power State 1 Descriptor (PSD1)
2143-2112	V		Indicates the characteristics of power state 2	Power State 2 Descriptor (PSD2)
2175-2144	V		Indicates the characteristics of power state 3	Power State 3 Descriptor (PSD3)
2207-2176	V		Indicates the characteristics of power state 4	Power State 4 Descriptor (PSD4)
2239-2208	V		Indicates the characteristics of power state 5	Power State 5 Descriptor (PSD5)
2271-2240	V		Indicates the characteristics of power state 6	Power State 6 Descriptor (PSD6)
2303-2272	V		Indicates the characteristics of power state 7	Power State 7 Descriptor (PSD7)
2335-2304	V		Indicates the characteristics of power state 8	Power State 8 Descriptor (PSD8)
2367-2336	V		Indicates the characteristics of power state 9	Power State 9 Descriptor (PSD9)
2399-2368	V		Indicates the characteristics of power state 10	Power State 10 Descriptor (PSD10)
2431-2400	V		Indicates the characteristics of power state 11	Power State 11 Descriptor (PSD11)
2463-2432	V		Indicates the characteristics of power state 12	Power State 12 Descriptor (PSD12)
2495-2464	V		Indicates the characteristics of power state 13	Power State 13 Descriptor (PSD13)
2527-2496	V		Indicates the characteristics of power state 14	Power State 14 Descriptor (PSD14)
2559-2528	V		Indicates the characteristics of power state 15	Power State 15 Descriptor (PSD15)
2591-2560	V		Indicates the characteristics of power state 16	Power State 16 Descriptor (PSD16)
2623-2592	V		Indicates the characteristics of power state 17	Power State 17 Descriptor (PSD17)
2655-2624	V		Indicates the characteristics of power state 18	Power State 18 Descriptor (PSD18)
2687-2656	V		Indicates the characteristics of power state 19	Power State 19 Descriptor (PSD19)
2719-2688	V		Indicates the characteristics of power state 20	Power State 20 Descriptor (PSD20)
2751-2720	V		Indicates the characteristics of	Power State 21 Descriptor (PSD21)



Bytes	F = Fixed V = Variable X = Both	Default Value	Interpretation	Description
			power state 21	
2783-2752	V		Indicates the characteristics of power state 22	Power State 22 Descriptor (PSD22)
2815-2784	V		Indicates the characteristics of power state 23	Power State 23 Descriptor (PSD23)
2847-2816	V		Indicates the characteristics of power state 24	Power State 24 Descriptor (PSD24)
2879-2848	V		Indicates the characteristics of power state 25	Power State 25 Descriptor (PSD25)
2911-2880	V		Indicates the characteristics of power state 26	Power State 26 Descriptor (PSD26)
2943-2912	V		Indicates the characteristics of power state 27	Power State 27 Descriptor (PSD27)
2975-2944	V		Indicates the characteristics of power state 28	Power State 28 Descriptor (PSD28)
3007-2976	V		Indicates the characteristics of power state 29	Power State 29 Descriptor (PSD29)
3039-3008	V		Indicates the characteristics of power state 30	Power State 30 Descriptor (PSD30)
3071-3040	V		Indicates the characteristics of power state 31	Power State 31 Descriptor (PSD31)
3095-3076	V	Varies	Shows healthy status or error code	Health indicator
3096	V	Varies	Reads current negotiated PCIe* link speed, as reported by PXLS register (PXCAP + 12h), bits[3:0]	Current PCIe Link Speed field (CLS)
3097	V	Varies	Reads current negotiated PCIe Link Width as reported by PXLS register (PXCAP + 12h), bits[9:4]	Negotiated Link Width (NLW)
4095-3098	V	NA	Range of bytes is allocated for vendor specific usage	Vendor Specific (VS)

NOTES:

F = Fixed. The content of the word is fixed and does not change. For removable media devices, these values may change when media is removed or changed.

V = Variable. The state of at least one bit in a word is variable and may change depending on the state of the device or the commands executed by the device.

X = F or V. The content of the word may be fixed or variable.



Table 30: Power State Descriptor

Bytes	F = Fixed V = Variable X = Both	Default Value	Interpretation	Description
255-125				Reserved
124-120	F	0h	Indicates the relative write latency associated with this power state	Relative Write Latency (RWL)
119-117				Reserved
116-112	F	0h	Indicates the relative write throughput associated with this power state	Relative Write Throughput (RWT)
111-109				Reserved
108-104	F	0h	Indicates the relative read latency associated with this power state	Relative Read Latency (RRL)
103-101				Reserved
100-96	F	0h	Indicates the relative read throughput associated with this power state.	Relative Read Throughput (RRT)
95-64	F	0h	Indicates the maximum exit latency in microseconds associated with exiting this power state.	Exit Latency (EXLAT)
63-32	F	0h	Indicates the maximum entry latency in microseconds associated with entering this power state	Entry Latency (ENLAT)
31-16				Reserved
15-00	F	09C4h	Indicates the maximum power consumed by the NVM subsystem in this power state. The power in Watts is equal to the value in this field multiplied by 0.01	Maximum Power (MP)



Table 31: Identify Namespace

Bytes	F = Fixed V = Variable X = Both	Default Value	Interpretation	Description
7-0	V	varies	Indicates the total size of the namespace in logical blocks.	Namespace Size (NSZE)
15-8	V	varies	Indicates the maximum number of logical blocks that may be allocated in the namespace at any point in time	Namespace Capacity (NCAP)
23-16	V	varies	Indicates the current number of logical blocks allocated in the namespace	Namespace Utilization (NUSE)
24	F	00h	Indicates thin provisioning is not supported	Namespace Features (NSFEAT)
25	F	06h	Defines the number of supported LBA size and metadata size combinations supported by the namespace	Number of LBA Formats (NLBAF)
26	V	00h	Indicates metadata transferred with the extended data LBA or in separate buffer	Formatted LBA Size (FLBAS)
27	F	03h	Indicates support for metadata transferred with the extended data LBA and in separate buffer – both are supported	Metadata Capabilities (MC)
28	V	11h	Indicates PI supports Type 1,2,3 with PI transferred as the first 8 bytes	End-to-end Data Protection Capabilities (DPC)
29	X	00h	Indicates type settings for the namespace	End-to-end Data Protection Type Settings (DPS)
127-30				Reserved
131-128	V	MS:0, LBADS:9, RP:2	Indicates the LBA format 0 that is supported by the controller	LBA Format 0 Support (LBAF0)
135-132	V	MS:8, LBADS:9, RP:2	Indicates the LBA format 1 that is supported by the controller	LBA Format 1 Support (LBAF1)
139-136	V	MS:16, LBADS:9, RP:2	Indicates the LBA format 2 that is supported by the controller	LBA Format 2 Support (LBAF2)
143-140	V	MS:0, LBADS:12, RP:0	Indicates the LBA format 3 that is supported by the controller	LBA Format 3 Support (LBAF3)
147-144	V	MS:8, LBADS:12, RP:0	Indicates the LBA format 4 that is supported by the controller	LBA Format 4 Support (LBAF4)
151-148	V	MS:64, LBADS:12, RP:0	Indicates the LBA format 5 that is supported by the controller	LBA Format 5 Support (LBAF5)



Bytes	F = Fixed V = Variable X = Both	Default Value	Interpretation	Description
155-152	V	MS:128, LBADS:12, RP:0	Indicates the LBA format 6 that is supported by the controller	LBA Format 6 Support (LBAF6)
159-156		Not supported	Indicates the LBA format 7 that is supported by the controller	LBA Format 7 Support (LBAF7)
163-160		Not supported	Indicates the LBA format 8 that is supported by the controller	LBA Format 8 Support (LBAF8)
167-164		Not supported	Indicates the LBA format 9 that is supported by the controller	LBA Format 9 Support (LBAF9)
171-168		Not supported	Indicates the LBA format 10 that is supported by the controller	LBA Format 10 Support (LBAF10)
175-172		Not supported	Indicates the LBA format 11 that is supported by the controller	LBA Format 11 Support (LBAF11)
179-176		Not supported	Indicates the LBA format 12 that is supported by the controller	LBA Format 12 Support (LBAF12)
183-180		Not supported	Indicates the LBA format 13 that is supported by the controller	LBA Format 13 Support (LBAF13)
187-184		Not supported	Indicates the LBA format 14 that is supported by the controller	LBA Format 14 Support (LBAF14)
191-188		Not supported	Indicates the LBA format 15 that is supported by the controller	LBA Format 15 Support (LBAF15)
383-192		Not supported		Reserved
4095-384		Not supported	Range of bytes is allocated for vendor specific usage	Vendor Specific (VS)

NOTES:

F = Fixed. The content of the word is fixed and does not change. For removable media devices, these values may change when media is removed or changed.

V = Variable. The state of at least one bit in a word is variable and may change depending on the state of the device or the commands executed by the device.

X = F or V. The content of the word may be fixed or variable



Table 32: LBA Format Data Structure

Bytes	F = Fixed V = Variable X = Both	Default Value	Interpretation	Description
31-26				Reserved
25-24	V	Varies (2,0)	Relative Performance ranging from "best" to "degraded"	Relative Performance (RP)
23-16	V	Varies (9 and 12)	Indicates the LBA data size supported. The value is reported in terms of a power of two (2^n)	LBA Data Size (LBADS)
15-00	V	Varies (0, 8, 16,64, 128)	Indicates the number of metadata bytes provided per LBA based on the LBA Data Size indicated.	Metadata Size (MS)

NOTES:

F = Fixed. The content of the word is fixed and does not change. For removable media devices, these values may change when media is removed or changed.

V = Variable. The state of at least one bit in a word is variable and may change depending on the state of the device or the commands executed by the device.

X = F or V. The content of the word may be fixed or variable.



Appendix B Vital Data Structure

Table 33: Vital Product Data Structure (VPD)

Address	# Bytes	Function	Programming Value	Byte	Description
0	3	Class Code	02h	0	Device type and Programming Interface
			08h	1	
			01h	2	
3	2	ID	86h	3	PCI-SIG Vendor ID
			80h	4	
5	20		Varies	5-24	Serial Number
25	40		Varies	25-64	Model Number
65	1	PCIe* Port0 Capabilities	03h	65	Maximum Link Speed
66	1		04h	66	Maximum Link Width
67	1	PCIe Port1 Capabilities	03h	67	Maximum Link Speed
68	1		04h	68	Maximum Link Width
69	1	Initial Power Requirements	0Ah	69	12V Power rail initial power requirement (W)
70	2	Reserved	00h	70-71	
72	1	Maximum Power Requirements	19h	72	12V Power rail maximum power requirement (W)
73	2	Reserved	00h	73-74	
75	2	Capability List Pointer	50h	75	16b address pointer to start of capability list

Table 34: Capability List Pointer (Out of Band Temperature Sensor)

Addr (Hex)	00	01	02	03	04	05	06	07	08	09	A	B
50	A2	00	00	00	00	36	00	00	varies	varies	varies	varies
Description	Capability ID (temp)	Next Capability (none)	Sensor Type	SMBUS address	Reserved	Warning Threshold	Over Temperature					

§



Appendix C Out of Band Temperature Sensor Read Out

Register 0x05 on address 0x1B contains the temperature information for the latest readout. Measured temperature is captured by bit 12 to bit 0. Data format is two's complement. Bit12 represents sign value, bit11 presents 128° C and bit0 represents 0.0625° C. Following table gives an example of the read out.

Table 35: Register 0x05 read out format

Binary	Hex	Temperature
1 1100 1001 0000	1C90	-55° C
1 1100 1110 0000	1CE0	-50° C
1 1110 0111 0000	1E70	-25° C
1 1111 1111 1111	1FFFF	-0.0625° C
0 0000 0000 0000	000	0° C
0 0000 0000 0001	001	0.0625° C
0 0001 1001 0000	190	25° C
0 0011 0010 0000	320	50° C
0 0111 1101 0000	7D0	55° C

§



Appendix D PCIe* ID

Table 36: PCIe* ID

ID name	Description	Add-in Card	2.5" FF	PCIe* Register Location	Identify Controller Location	Vital Product Data Location
Vendor ID (VID)	Vendor ID assigned by PCI-SIG	0x8086	0x8086	PCI Header Offset 00h (bits 15:00)	Bytes 01:00h	Address 3, (size 2B)
Device ID (DID)	Device ID assigned by vendor	0x0953	0x0953	PCI Header Offset 00h (bits 31:16)	NA	NA
Subsystem Vendor ID	Indicates Sub-system vendor ID	0x8086	0x8086	PCI Header Offset 2Ch (bits 15:00)	Bytes 03:02h	NA
Subsystem ID	Sub-system identifier	0x3709	0x370A	PCI Header Offset 2Ch (bits 31:16)	NA	NA



Appendix E SCSI Command Translation

Following SCSI commands are supported:

- Read 6,10,12,16
- Inquiry
- Mode Sense 6,10
- Mode Select 6.10
- Log Sense
- Read Capacity 10,16
- Report LUNs
- Request Sense
- Start Stop Unit
- Test Unit Ready
- Write Buffer
- Unmap

NOTES: Refer to NVM Express*: SCSI translation reference doc under nvmexpress.org

Appendix F Add-in Card LED Decoder

Table 37: LED Functionality

LED	Description	Blink Behavior
LED 1 (Amber)	Shows IO activity	Blinks at the rate of 250msec high, 250msec low with IO activity
LED 2 (Red)	Drive fail indicator	Solid red if drive is in disabled logical mode
LED 3 (Yellow)	Drive pre-fail indicator	Solid yellow if any of the critical warnings in log page 0x02 is triggered
LED 4 (Green)	Drive health indicator	Solid green when drive is healthy

Figure A-1 LED Location

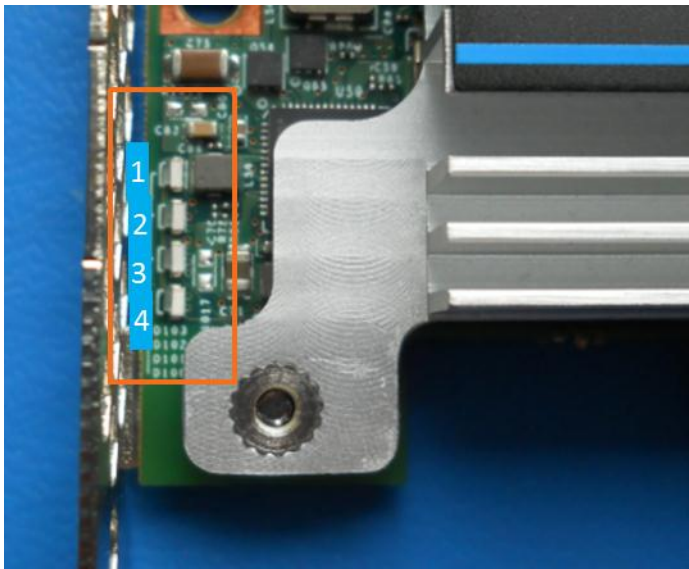

Note: 2.5" Form factor does not contain LEDs

§