

Introduction: Thank you for deciding to purchase a be quiet! product. The following instructions will guide you through the installation process. If you do encounter installation problems, please don't hesitate to contact our customer services by mailing service@bequiet.com. Please note that be quiet! cannot accept liability for damage caused by compatibility problems.

Warranty:

- 3 years manufacturer guarantee for consumers (original purchase from authorized be quiet! dealers only)
- Guarantee work can only be processed with an included copy of the purchase receipt from an authorized be quiet! dealer
- Manipulation and structural changes of any kind as well as damages through external mechanical forces lead to a complete voiding of the guarantee
- Our General Warranty Conditions apply, which can be viewed on bequiet.com

Listan GmbH & Co.KG . Biedenkamp 3a . 21509 Glinde Germany

For further information contact us via e-mail: service@bequiet.com



DARK ROCK TF

! We recommend removal of the cooler prior to transportation.

June 2017



DARK ROCK TF

be quiet!®

SCOPE OF DELIVERY

	Part name	Quantity
①	be quiet! Dark Rock TF cooler	1
②	Intel backplate	1
③	AMD backplate	1
④	Intel mounting brackets	2
⑤	Short AMD mounting brackets	2
⑥	Hexagonal nuts with sleeve	4
⑦	Spacer nuts	4
⑧	Spacer nuts	4

	Part name	Quantity
⑨	M3x16 screws	4
⑩	AMD M3x15 screws	4
⑪	M3x3 screws	4
⑫	C-profile spacers	4
⑬	AMD washers	4
⑭	Hexagonal wrench	1
⑮	Thermal paste	1
⑯	Fans	2
⑰	Fan clips	4
⑱	Y cable	1

Intel LGA 2011(-3) square ILM / LGA 2066

General

We recommend mounting the cooler outside the PC case.

The following parts are needed for this:

1x be quiet! Dark Rock TF CPU cooler (1), 2x Intel mounting brackets (4), 4x spacer nuts (7), 4x hexagonal nuts (8), 4x M3x3 screws (11), 1x hexagonal wrench (14), 1x thermal paste (15), fans (16), fan clips (17), Y cable (18)

First screw the spacer nuts (7) onto the threads of the socket frame. Use the hexagonal wrench (14) for this.

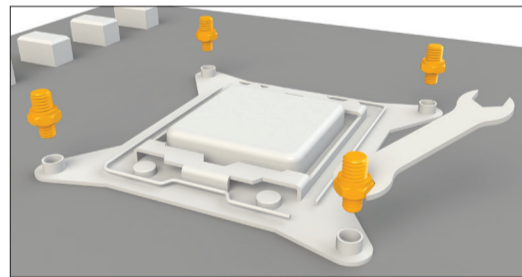

Installation of the mounting brackets

Attach the two Intel mounting brackets (4) to the underside of the CPU cooler using the M3x3 screws (11).

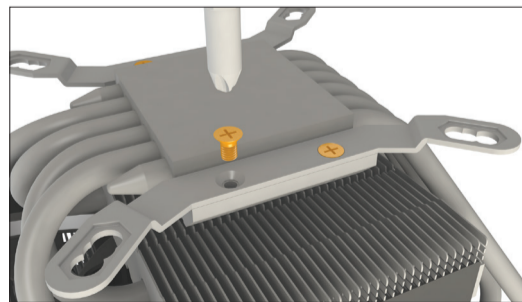

Mounting the CPU cooler

First remove the protective foil from the underside of the cooler. Spread the thermal paste (15) on the surface of the CPU. The amount supplied is sufficient for one or two applications.

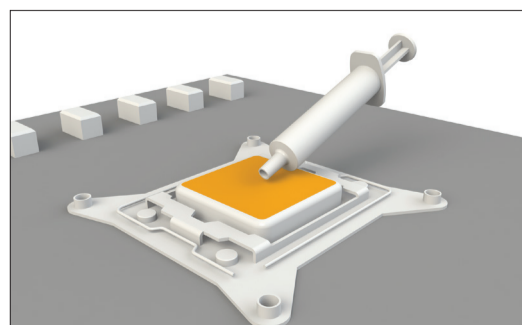

Use the fan clips (17) to mount the fans (16) with the logo facing upwards on the rubber inserts and connect them with the Y cable (18) to the CPU fan connector on the motherboard.

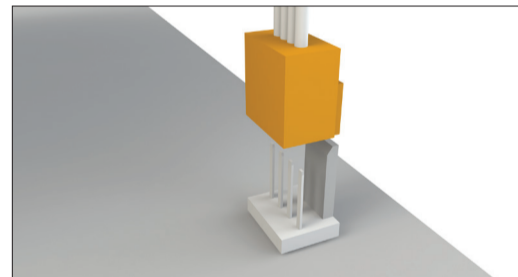

Position the cooler over the CPU.

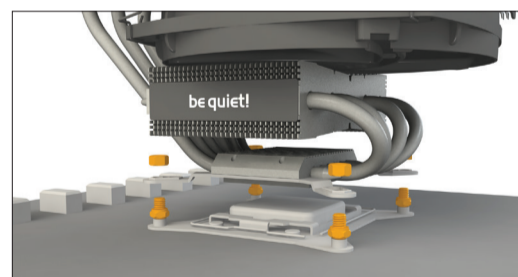

Place the hexagonal nuts (8) over the spacer nuts (7) and progressively tighten these in a crosswise manner until firm using the hexagonal wrench (14).

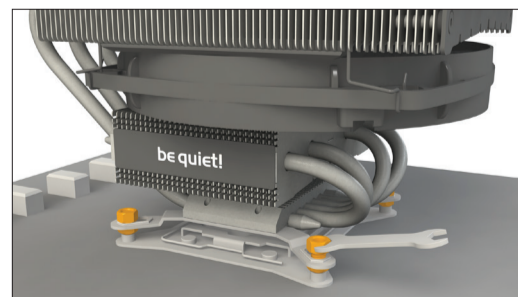

Intel LGA 775 / 1366 / 1150 / 1151 / 1155 / 1156

General

With preassembled motherboards we recommend installing the cooler inside the PC case over the motherboard cutout.

The following parts are needed for this:

1x be quiet! Dark Rock TF CPU cooler (1), 1x Intel backplate (2), 2x Intel mounting brackets (4), 4x hexagonal nuts with sleeve (6), 4x hexagonal nuts (8), 4x M3x16 screws (9), 4x M3x3 screws (11), 4x C-profile spacers (12), 1x hexagonal wrench (14), 1x thermal paste (15), fans (16), fan clips (17), Y cable (18)

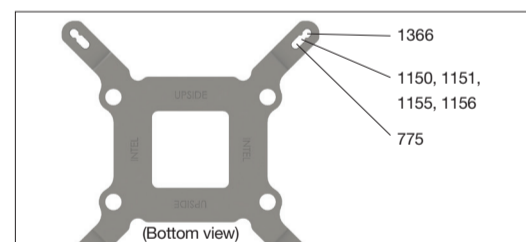

Affixing the backplate

Position the Intel backplate (2) on the rear side of the motherboard. Then insert the M3x16 screws (9) through the drill holes situated on the rear side of the backplate.

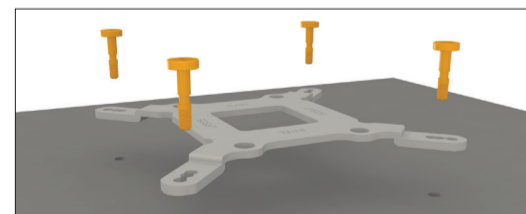

Fasten the backplate on the front side of the motherboard using the C-profile spacers (12) by pressing these onto the notches in the M3x16 screws (9) until they click in.

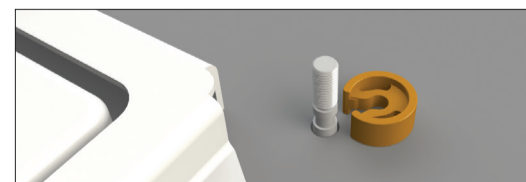

Assembly of the mounting brackets

Insert the hexagonal nut with sleeve (6) from below through each Intel mounting bracket (4) and screw together from above with the hexagonal nuts (8). Use the hexagonal wrench (14) for this.

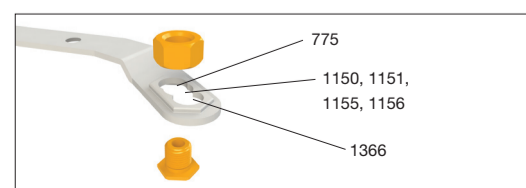

Installing of the mounting brackets

Attach the two Intel mounting brackets (4) to the underside of the CPU cooler using the M3x3 screws (11).

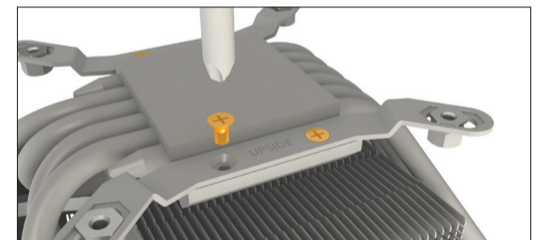

Mounting the CPU cooler

First remove the protective foil from the underside of the cooler. Spread the thermal paste (15) on the surface of the CPU. The amount supplied is sufficient for one or two applications.

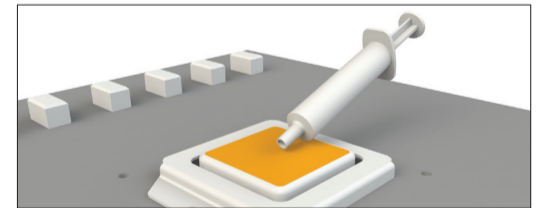

Use the fan clips (17) to mount the fans (16) with the logo facing upwards on the rubber inserts and connect them with the Y cable (18) to the CPU fan connector on the motherboard.

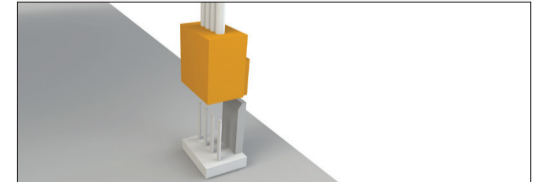

Position the cooler so that it is possible to attach the cooler by screwing together the M3x16 screws (9)

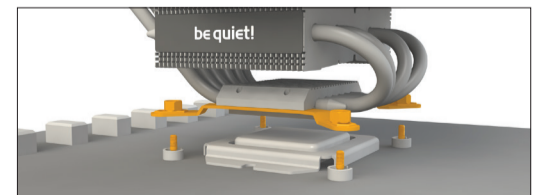

on the rear side of the motherboard into the hexagonal nuts with sleeve (6) attached to the cooler.

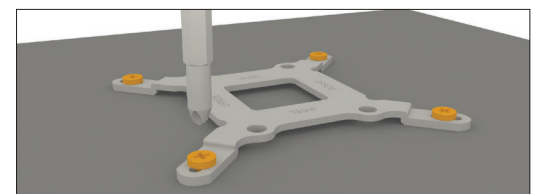

General

With pre-mounted motherboards we recommend installing the cooler inside the PC case over the motherboard cutout. Removing the AMD retention module is performed at your own risk.

The following parts are needed for this:

1x be quiet! Dark Rock TF CPU cooler (1), 1x AMD backplate (3), 2x short AMD mounting brackets (5), 4x hexagonal nuts with sleeve (6), 4x hexagonal nuts (8), 4x AMD M3x15 (10), 4x M3x3 screws (11), 4x C-profile spacers (12), 4x AMD washers (13), 1x hexagonal wrench (14), 1x thermal paste (15), fans (16), fan clips (17), Y cable (18)

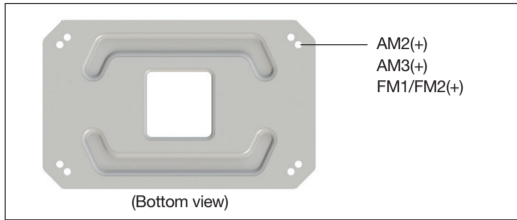

Removal of the AMD retention module

Before you are able to install the CPU cooler, you must first remove the preassembled AMD retention module from the motherboard. To do this remove the four screws from around the socket

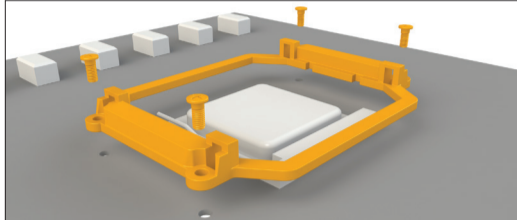

Mounting the backplate

Position the AMD backplate (3) vertically on the rear side of the motherboard. Then insert the AMD M3x15 (10) through the drill holes on the rear side of the backplate.

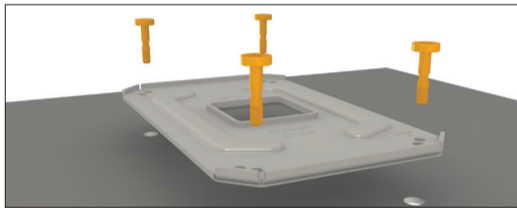

On the front side of the motherboard, pass the AMD washers (13) over the projecting AMD M3x15 (10) to cover the motherboard screw holes.

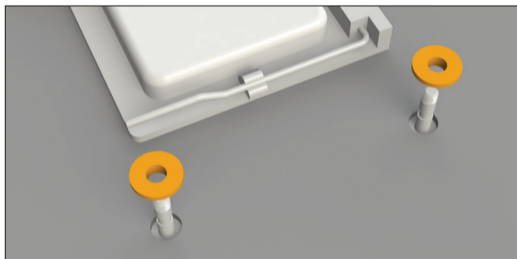

Now fasten the backplate on the front side of the motherboard using the C-profile spacers (12) by pressing these onto the notches in the AMD M3x15 (10) until they click in.



Preparing the mounting brackets

Pass the hexagonal nuts with sleeve (6) from below through the ends of short AMD mounting brackets (5) and screw together with the hexagonal nuts (8). Use the hexagonal wrench (14) for this.

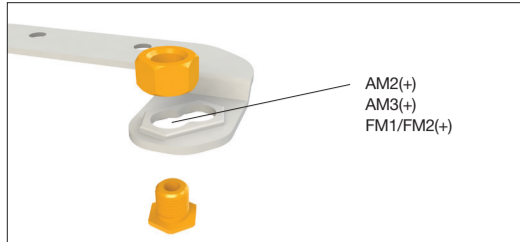

Assembly of the mounting brackets

Attach the two short AMD mounting brackets (5) to the underside of the CPU cooler using the M3x3 screws (11).

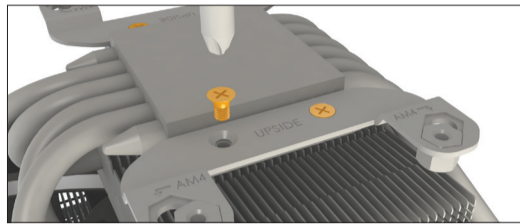

Mounting the CPU cooler

First remove the protective foil from the underside of the cooler. Spread the thermal paste (15) on the surface of the CPU. The amount supplied is sufficient for one or two applications.

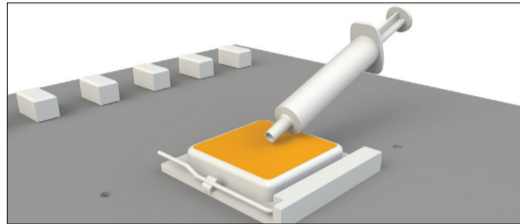

Use the fan clips (17) to mount the fans (16) with the logo facing upwards on the rubber inserts and connect them with the Y cable (18) to the CPU fan connector on the motherboard.

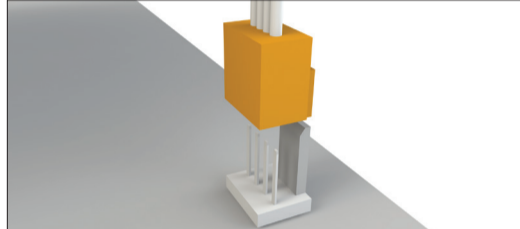

Position the cooler above the CPU, passing the attached AMD mounting brackets (5) over the projecting AMD M3x15 (10)

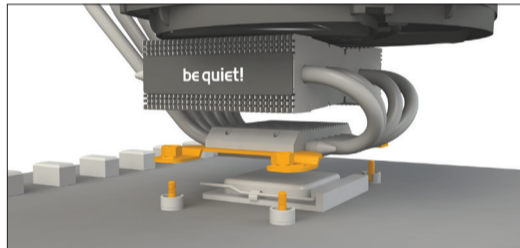

and affix by turning the AMD M3x15 (10) from the rear side of the motherboard.

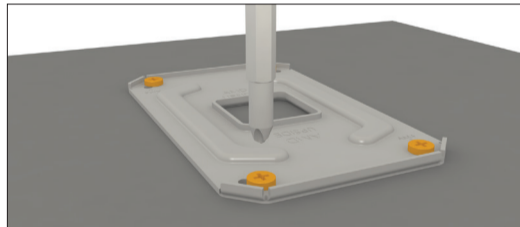

General

With preassembled motherboards we recommend installing the cooler inside the PC case over the motherboard cutout. Removing the AMD retention module is performed at your own risk.

The following parts are needed for this:

1x be quiet! Dark Rock TF CPU cooler (1), 1x AMD backplate (3), 2x short AMD mounting brackets (5), 4x hexagonal nuts with sleeve (6), 4x Hexagonal nuts (8), 4x AMD M3x15 screws (10), 4x M3x3 screws (11), 4x C-profile spacers (12), 4x AMD washers (13), 1x hexagonal wrench (14), 1x thermal paste (15), fans (16), fan clips (17), Y cable (18)

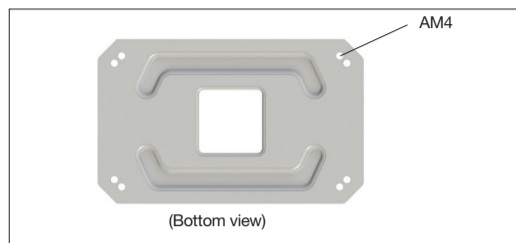

Removal of the AMD AM4 retention module

Before you are able to install the CPU cooler, you must first remove the preassembled AMD AM4 retention module from the motherboard. To do this remove the four screws from around the socket.

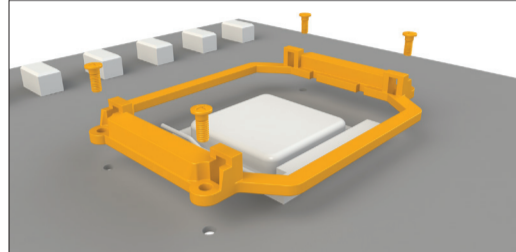

Mounting the backplate

Position the AMD backplate (3) vertically on the rear side of the motherboard. Then insert the AMD M3x15 screws (10) through the drill holes on the rear side of the backplate.

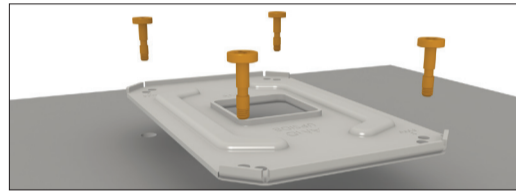

On the front side of the motherboard, pass the AMD washers (13) over the projecting AMD M3x15 screws (10) to cover the motherboard screw holes.



Now fasten the backplate using the C-profile spacers (12) by pressing these onto the notches in the AMD M3x15 screws (10) until they click in.



Preparing the mounting brackets

Pass the hexagonal nuts with sleeve (6) from below through the ends of short AMD mounting brackets (5) and screw together with the hexagonal nuts (8). Use the hexagonal wrench (14) for this.

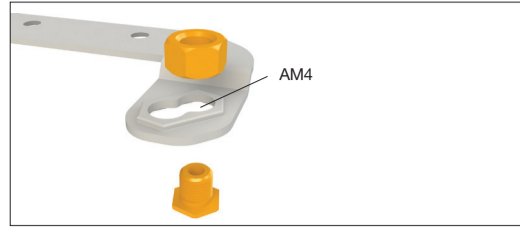

Installing the mounting brackets

Attach the two short AMD mounting brackets (5) to the underside of the CPU cooler using the M3x3 screws (11).

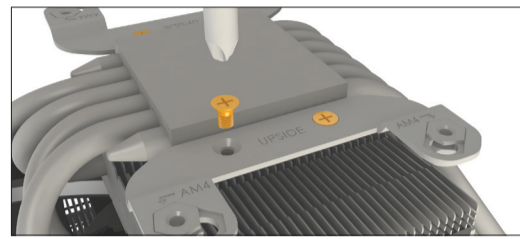

Mounting the CPU cooler

First remove the protective foil from the underside of the cooler. Spread the thermal paste (15) on the surface of the CPU.

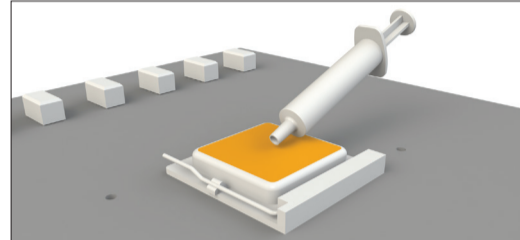

Use the fan clips (17) to mount the fans (16) with the logo facing upwards on the rubber inserts and connect them with the Y cable (18) to the CPU fan connector on the motherboard.

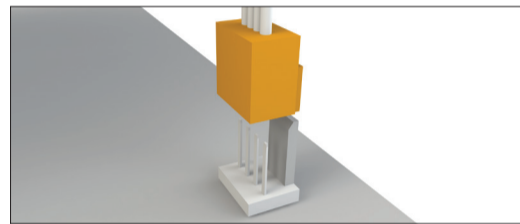

Position the cooler above the CPU, passing the attached AMD mounting brackets (5) over the projecting AMD M3x15 screws (10)

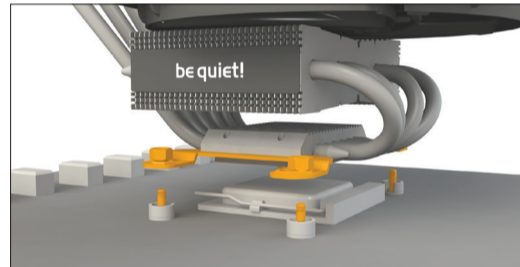

and affix by turning the AMD M3x15 screws (10) from the rear side of the motherboard.

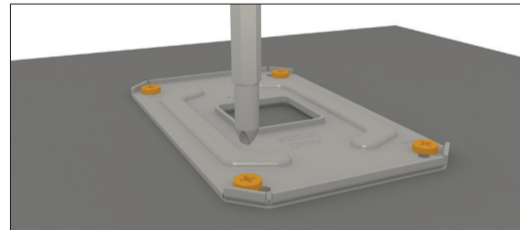

Notes
