

User's Manual

N8900 series/N12000 series/N16000 series/N12850/N16850
N5550/N5810/N5810PRO/N6850/N8850/N10850/
N7700PRO V2/N7710 series/N8800PRO V2 /
N8810U series/N4510U series/N7510/N7770-10G/N8880U-10G

Copyright and Trademark Notice

Thecus and other names of Thecus products are registered trademarks of Thecus Technology Corp. Microsoft, Windows, and the Windows logo are registered trademarks of Microsoft Corporation. Apple, iTunes and Apple OS X are registered trademarks of Apple Computers, Inc. All other trademarks and brand names are the property of their respective owners. Specifications are subject to change without notice.

Copyright © 2016 Thecus Technology Corporation. All rights reserved.

About This Manual

All information in this manual has been carefully verified to ensure its correctness. In case of an error, please provide us with your feedback. Thecus Technology Corporation reserves the right to modify the contents of this manual without notice.

Product name: Thecus N8900 series / N12000 / N16000
series/N12850/N16850/N6850/N8850/N10850/N7700PRO V2/N8800PRO
V2/N7710 series/N8810U series/N5550/N4510U
series/N7510/N5810/N5810PRO/N7770-10G/N8880U-10G
Manual Version: 6.3
Release Date: March 2016

Limited Warranty

Thecus Technology Corporation guarantees all components of Thecus NAS products are thoroughly tested before they leave the factory and should function normally under general usage. In case of any system malfunctions, Thecus Technology Corporation and its local representatives and dealers are responsible for repair without cost to the customer if the product fails within the warranty period and under normal usage. Thecus Technology Corporation is not responsible for any damage or loss of data deemed to be caused by its products. It is highly recommended that users conduct necessary back-up practices.

Check the functions that are available on your particular Thecus NAS model at:

<http://www.Thecus.com>

Safety Warnings

For your safety, please read and follow the following safety warnings:















-  Read this manual thoroughly before attempting to set up your Thecus IP storage.
-  Your Thecus IP storage is a complicated electronic device. DO NOT attempt to repair it under any circumstances. In the case of malfunction, turn off the power immediately and have it repaired at a qualified service center. Contact your vendor for details.
-  DO NOT allow anything to rest on the power cord and DO NOT place the power cord in an area where it can be stepped on. Carefully place connecting cables to avoid stepping or tripping on them.
-  Your Thecus IP storage can operate normally under temperatures between 5°C and 40°C, with relative humidity of 20% – 85%. Using Thecus IP storage under extreme environmental conditions could damage the unit.
-  Ensure that the Thecus IP storage is provided with the correct supply voltage. Plugging the Thecus IP storage to an incorrect power source could damage the unit.
-  Do NOT expose Thecus IP storage to dampness, dust, or corrosive liquids.
-  Do NOT place Thecus IP storage on any uneven surfaces.
-  DO NOT place Thecus IP storage in direct sunlight or expose it to other heat sources.
-  DO NOT use chemicals or aerosols to clean Thecus IP storage. Unplug the power cord and all connected cables before cleaning.
-  DO NOT place any objects on the Thecus IP storage or obstruct its ventilation slots to avoid overheating the unit.
-  Keep packaging out of the reach of children.
-  If disposing of the device, please follow your local regulations for the safe disposal of electronic products to protect the environment.
-  Risk of explosion if battery is replaced by an incorrect type.
-  Dispose of used batteries according to the instructions

Table of Contents

Copyright and Trademark Notice	2
About This Manual	2
Limited Warranty	2
Safety Warnings	3
Table of Contents	4
Chapter 1: Introduction	7
Overview	7
Product Highlights	7
Package Contents	9
Front Panel	10
Rear Panel	25
Chapter 2: Hardware Installation	42
Overview	42
Before You Begin	42
Cable Connections	42
Chapter 3: First Time Setup	46
Overview	46
Thecus Setup Wizard	46
LCD Operation (N7700PRO V2/N8800PRO V2/ N7710 series/N8810U series/N5550/N5810/N5810PRO/N4510U series/N7510/N7770-10G/N8880U-10G/N12850/N16850)	48
OLED Operation(Does not apply to the N7700PRO V2/N8800PRO V2/ N7710 series/N8810U series/N5550/N5810/N5810PRO/N4510U series/N7510/N7770-10G/N8880U-10G)	50
USB Copy	50
Typical Setup Procedure	51
Chapter 4: System Administration	53
Overview	53
Web Administration Interface	53
My Favorite.....	54
Logout	56
Language Selection	56
System Information	57
General	57
Status	58
Logs.....	58
Syslog Management.....	60
System Monitor	61
Hardware Information	63
User Access Log	63
System Management	66
Date and Time: Setting system time	66
Notification configuration	66
Firmware Upgrade	67
Schedule Power On/Off.....	68
Administrator Password	69
Config Mgmt	70
Factory Default.....	70
Power Management:	71

File System Check	72
Wake-Up On LAN (WOL)	74
SNMP Support	74
UI Login Function	74
System Network	75
Networking	75
VLAN	76
DHCP/RADVD	77
Linking Aggregation	78
Additional LAN	80
Storage Management	82
Disk Information	82
RAID Information	85
NAS Stacking	98
ISO Mount	104
Share Folder	107
Folder and sub-folders Access Control List (ACL)	110
Snapshot	112
iSCSI	116
iSCSI Thin-Provisioning	122
Advance Option	123
Disk Clone and Wipe	124
High-Availability (N8900, N12000 series/N16000 series/N12850/N16850 only)	126
User and Group Authentication	135
ADS/NT Support	135
Local User Configuration	137
Local Group Configuration	139
Batch Users and Groups Creation	141
User Quota	142
User and Group Backup	142
LDAP Support	143
Network Service	143
Samba / CIFS	143
AFP (Apple Network Setup)	146
NFS Setup	147
FTP	147
TFTP	149
WebService	149
UPnP	150
Bonjour Setting	150
SSH	151
DDNS	152
UPnP Port Management	152
WebDAV	154
Auto-Thumbnail	155
Thecus ID	155
VPN Client	157
VPN Server	158
Application Server	160
iTunes® Server	160
App Installation	160
Auto App Installation	161
Backup	162
Dual DOM (N12000 series/N16000 series/N8900 series/N12850/N16850 only)	162
Rsync Target Server	162
ACL Backup and Restore	164

Data Burn.....	165
Data Guard (Remote Backup).....	168
Full Backup	170
Custom Backup.....	172
iSCSI Backup.....	174
Restore.....	175
Data Guard (Local Backup)	179
USB Copy	195
Volume Expansion Management	197
Thecus Backup Utility	198
Windows XP Data Backup	198
Apple OS X Backup Utilities.....	199
External Devices.....	199
Printers	199
Uninterrupted Power Source.....	204
Chapter 5: Tips and Tricks	205
USB and eSATA Storage Expansion.....	205
Remote Administration.....	205
Part I - Setup a DynDNS Account	206
Part II - Enable DDNS on the Router	206
Part III - Setting up Virtual Servers (HTTPS).....	206
Firewall Software Configuration	206
Replacing Damaged Hard Drives	207
Hard Drive Damage	207
Replacing a Hard Drive.....	207
RAID Auto-Rebuild.....	207
Chapter 6: Troubleshooting	208
Forgot My Network IP Address.....	208
Can't Map a Network Drive in Windows XP	208
Restoring Factory Defaults	208
Problems with Time and Date Settings	209
Dual DOM Supports for Dual Protection (N12000 series/N16000 series/N8900 series/N12850/N16850 only).....	209
Appendix A: Customer Support.....	210
Appendix B: RAID Basics	211
Overview	211
Benefits.....	211
Improved Performance	211
Data Security	211
RAID Levels.....	211
Appendix C: How to open the top cover	214
N8900 series:	214
N12000 series/N12850:	215
N16000 series/N16850:	215
Appendix D: Active Directory Basics	216
Overview	216
What is Active Directory?	216
ADS Benefits.....	216
Appendix E: Licensing Information.....	217
Overview	217
Source Code Availability	217
CGIC License Terms.....	218
GNU General Public License.....	218

Chapter 1: Introduction

Overview

Thank you for choosing the Thecus IP Storage Server. The Thecus IP storage is an easy-to-use storage server that allows a dedicated approach to storing and distributing data on a network. Data reliability is ensured with RAID features that provide data security and recovery—over multiple Terabyte of storage are available using RAID 5 and RAID 6. Gigabit Ethernet ports enhance network efficiency, allowing Thecus IP storage to take over file management functions, increase application and data sharing and provide faster data response. The Thecus IP storage offers data mobility with a disk roaming feature that lets you swap working hard drives for use in other Thecus IP storage, securing the continuity of data in the event of hardware failure. The Thecus IP storage allows data consolidation and sharing between Windows (SMB/CIFS), UNIX/Linux, and Apple OS X environments. The Thecus IP storage's user-friendly GUI supports multiple Languages.

Product Highlights

File Server

First and foremost, the Thecus IP storage allows you to store and share files over an IP network. With a Network Attached Storage (NAS) device, you can centralize your files and share them easily over your network. With the easy-to-use web-based interface, users on your network can access these files in a snap.

To learn about the Web User Interface, go to

Chapter 4: Using the Thecus IP Storage > [Web Administration Interface](#)

FTP Server

With the built-in FTP Server, friends, clients, and customers can upload and download files to your Thecus IP storage over the Internet with their favorite FTP programs. You can create user accounts so that only authorized users have access.

To set up the FTP Server, refer to

Chapter 4: Network Service> [FTP](#) .

iTunes Server

With the built-in iTunes server capability, the Thecus IP storage enables digital music to be shared and played anywhere on the network!

To set up the iTunes Server, refer to

Chapter 4: Application Server>[iTunes Configuration](#).

Printer Server

With the Thecus IP storage's Printer Server, you can easily share an IPP printer with other PCs connected to your network.

To set up the Printer Server, refer to

Chapter 4: External Devices Server>[Printer Information](#).

Multiple RAID

Thecus IP storage supports multiple RAID volumes on one system. So, you can create RAID 0 for your non-critical data, and create RAID 1,5,6,50 or 60 (depend on model) for mission-critical data. Create the RAID levels depending on your needs.

To configure RAID modes on the Thecus IP storage, refer to **Chapter 4: Storage Management > RAID Information**.

iSCSI Capability

Thecus IP storage is not only a file server, but it also supports iSCSI initiators. Your server can access Thecus IP storage as a direct-attached-storage over the LAN or Internet. There is no easier way to expand the capacity of your current application servers. All the storage needs can be centrally managed and deployed. This brings ultimate flexibility to users.

To set up an iSCSI volume, refer to **Chapter 4: Storage Management > iSCSI**

Superior Power Management

Thecus IP storage supports schedule power on/off. With this feature, administrator can set at what time to turn on or off the system. This feature is a big plus for people who want to conserve energy. Wake-On-LAN enables administrator to remotely turn on the system without even leaving their own seat.

To schedule system on and off, refer to **Chapter 4: System Management > Scheduled Power On/Off**

Package Contents

N8900 Series/N12000/N16000 Series/N12850/N16850/N8800PRO V2/N8810U series/N4510U-R/N4510U PRO-R/N8880U-10G

The Thecus IP storage should contain the following common items:

- System Unit x1
- QIG (Quick Installation Guide) x1
- CD-Title (Acronis backup CD & Universal CD)
- Ethernet Cable x1
- Accessory bag x1
- HDD Compatibility list Card x1
- Multiple Languages Warranty Card x1
- Power cord x2

N6850/N8850/N10850/N7700PRO V2/N7710 series/N5550/N4510U-S/N7510/N4510U PRO-S/N5810/N5810PRO/N7770-10G

The Thecus IP storage should contain the following common items:

- System Unit x1
- QIG (Quick Installation Guide) x1
- CD-Title (Acronis backup CD & Universal CD)
- Ethernet Cable x1
- Accessory bag x1
- HDD Compatibility list Card x1
- Multiple Languages Warranty Card x1
- Power cord x1

Please check to see if your package is complete. If you find that some items are missing, contact your dealer.

Front Panel

N8900 series:

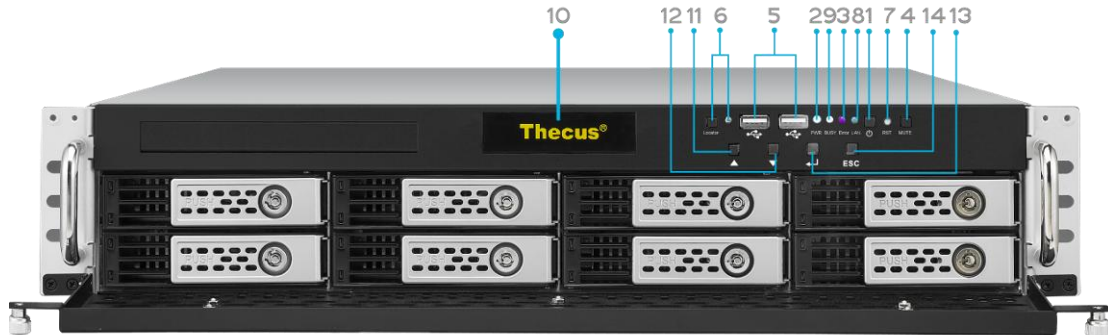

Front Panel	
Item	Description
1.Power Button	<ul style="list-style-type: none"> Power on/off N8900
2.Power LED	<ul style="list-style-type: none"> Solid green: System is power on.
3.System error LED	<ul style="list-style-type: none"> Solid RED: System error.
4.Mute button	<ul style="list-style-type: none"> Mute the system fan alarm.
5.USB Port	<ul style="list-style-type: none"> USB 2.0 port for compatible USB devices, such as USB disks and USB printers
6. Locator button / LED	<ul style="list-style-type: none"> Press the button, the back led will light up to identify the system position of the rack
7. RST	<ul style="list-style-type: none"> Reboot system.
8. LAN	<ul style="list-style-type: none"> Blinking green: network activity Solid green: network link
9. BUSY	<ul style="list-style-type: none"> Blinking orange: system startup or system maintenance; data currently inaccessible
10.OLED	<ul style="list-style-type: none"> Displays current system status and messages OLED screen saver will be enabled after screen is idle for more than 3 minutes OLED screen will be turn off after idle for more than 6 minutes
11.Up Button ▲	<ul style="list-style-type: none"> Push to scroll up when using the OLED display
12.Down Button ▼	<ul style="list-style-type: none"> Push to enter USB copy operation screen
13.Enter Button ↵	<ul style="list-style-type: none"> Push to enter OLED operate password for basic system setting
14.Escape Button ESC	<ul style="list-style-type: none"> Push to leave the current OLED menu

N12000 series:

The Thecus N12000 series front panel has the device's controls, indicators, and hard disk trays:

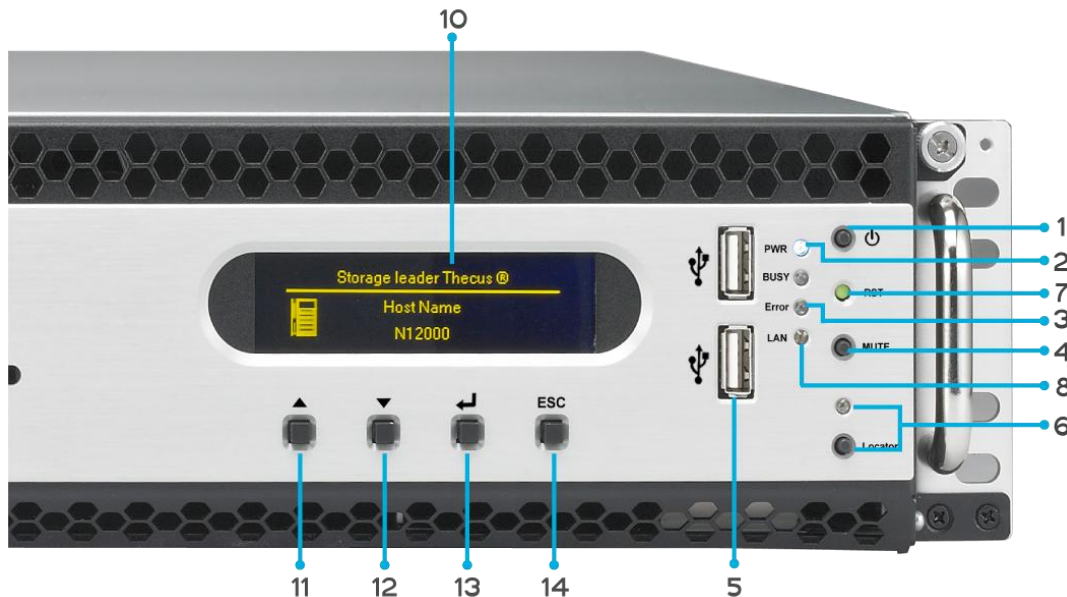

Front Panel	
Item	Description
1.Power Button	• Power on/off N12000
2.Power LED	• Solid green: System is power on.
3.System error LED	• Solid RED: System error.
4.Mute button	• Mute the system fan alarm.
5.USB Port	• USB 2.0 port for compatible USB devices, such as USB disks and USB printers
6. Locator button / LED	• Press the button, the back led will light up to identify the system position of the rack
7. RST	• Reboot system.
8. LAN	• Blinking green: network activity • Solid green: network link
9. BUSY	• Blinking orange: system startup or system maintenance; data currently inaccessible
10.OLED	• Displays current system status and messages • OLED screen saver will be enabled after screen is idle for more than 3 minutes • OLED screen will be turn off after idle for more than 6 minutes
11.Up Button ▲	• Push to scroll up when using the OLED display
12.Down Button ▼	• Push to enter USB copy operation screen
13.Enter Button ↵	• Push to enter OLED operate password for basic system setting
14.Escape Button ESC	• Push to leave the current OLED menu

N16000 series:

The Thecus N16000 series front panel has the device's controls, indicators, and hard disk trays:

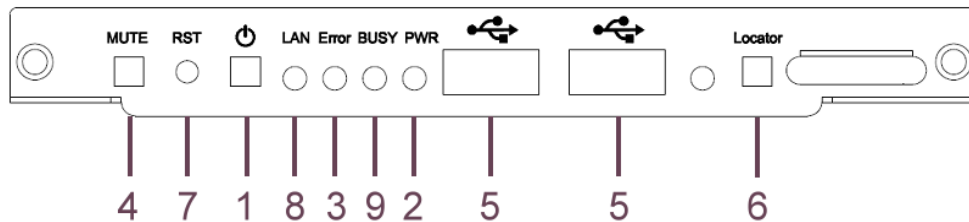

Front Panel	
Item	Description
1.Power Button	<ul style="list-style-type: none"> Power on/off N16000
2.Power LED	<ul style="list-style-type: none"> Solid green: System is power on.
3.System error LED	<ul style="list-style-type: none"> Solid RED: System error.
4.Mute button	<ul style="list-style-type: none"> Mute the system fan alarm.
5.USB Port	<ul style="list-style-type: none"> USB 2.0 port for compatible USB devices, such as USB disks and USB printers
6. Locator button / LED	<ul style="list-style-type: none"> Press the button, the back led will light up to identify the rack position of the system
7. RST	<ul style="list-style-type: none"> Reboot system.
8. LAN	<ul style="list-style-type: none"> Blinking green: network activity Solid green: network link
9. BUSY	<ul style="list-style-type: none"> Blinking orange: system startup or system maintenance; data currently inaccessible
10.OLED	<ul style="list-style-type: none"> Displays current system status and messages OLED screen saver will be enabled after screen is idle for more than 3 minutes OLED screen will be turn off after idle for more than 6 minutes
11.Up Button ▲	<ul style="list-style-type: none"> Push to scroll up when using the OLED display
12.Down Button ▼	<ul style="list-style-type: none"> Push to enter USB copy operation screen
13.Enter Button ↵	<ul style="list-style-type: none"> Push to enter OLED operate password for basic system setting
14.Escape Button ESC	<ul style="list-style-type: none"> Push to leave the current OLED menu

N6850:

The Thecus N6850's front panel has the device's controls, indicators, and hard disk trays:

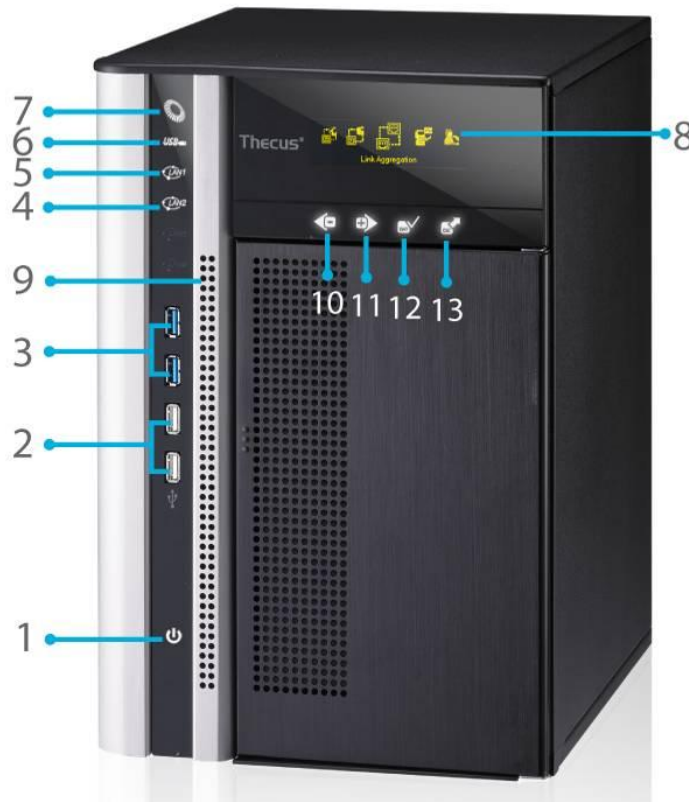

Front Panel	
Item	Description
1. Power Button	<ul style="list-style-type: none"> • Power on/off N6850
2. USB Port	<ul style="list-style-type: none"> • USB 2.0 port for compatible USB devices, such as digital cameras, USB disks, and USB printers.
3. USB Port	<ul style="list-style-type: none"> • USB 3.0 port for compatible USB devices, such as digital cameras, USB disks, and USB printers.
4. LAN2 LED	<ul style="list-style-type: none"> • Solid white: LAN2 Cable link • Blinking : Network activity
5. LAN1 LED	<ul style="list-style-type: none"> • Solid white: LAN1 Cable link • Blinking : Network activity
6. USB LED	<ul style="list-style-type: none"> • Solid white: USB busy • Solid Red: USB error
7. System LED	<ul style="list-style-type: none"> • Solid white: System is power on.
8. OLED	<ul style="list-style-type: none"> • Displays system status and information
9. System Error LED	<ul style="list-style-type: none"> • Blinking RED: System error.
10. Down Button	<ul style="list-style-type: none"> • Push to enter USB copy operation screen
11. Up Button	<ul style="list-style-type: none"> • Push to scroll up when using the OLED display
12. Enter Button	<ul style="list-style-type: none"> • Push to enter OLED operate password for basic system setting
13. Escape Button	<ul style="list-style-type: none"> • Push to leave the current OLED menu

N8850:

The Thecus N8850's front panel has the device's controls, indicators, and hard disk trays:

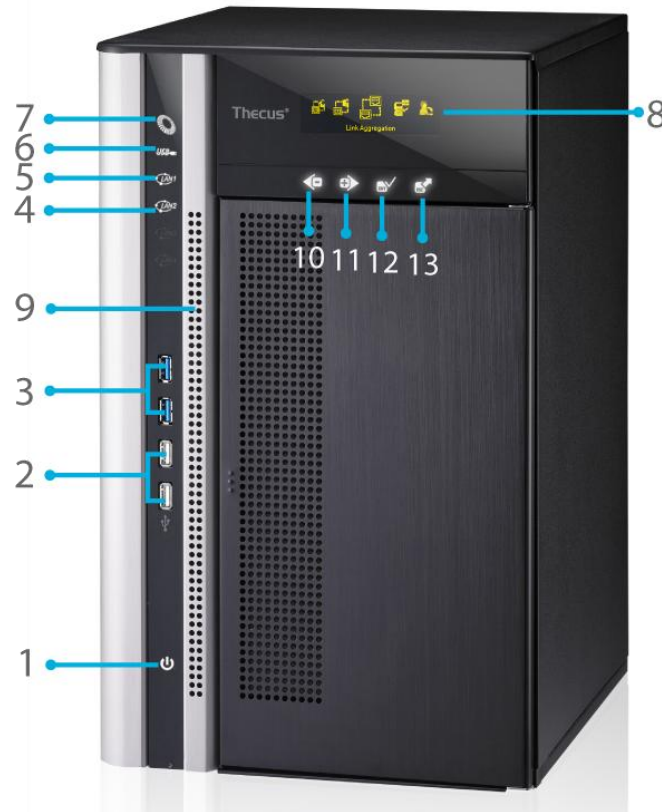

Front Panel	
Item	Description
1. Power Button	• Power on/off N8850
2. USB Port	• USB 2.0 port for compatible USB devices, such as digital cameras, USB disks, and USB printers.
3. USB Port	• USB 3.0 port for compatible USB devices, such as digital cameras, USB disks, and USB printers.
4. LAN2 LED	• Solid white: LAN2 Cable link • Blinking : Network activity
5. LAN1 LED	• Solid white: LAN1 Cable link • Blinking : Network activity
6. USB LED	• Solid white: USB busy • Solid Red: USB error
7. System LED	• Solid white: System is power on.
8. OLED	• Displays system status and information
9. System Error LED	• Blinking RED: System error.
10. Down Button	• Push to enter USB copy operation screen
11. Up Button	• Push to scroll up when using the OLED display
12. Enter Button	• Push to enter OLED operate password for basic system setting
13. Escape Button	• Push to leave the current OLED menu

N10850:

The Thecus N10850's front panel has the device's controls, indicators, and hard disk trays:



Front Panel	
Item	Description
1. Power Button	• Power on/off N10850
2. USB Port	• USB 2.0 port for compatible USB devices, such as digital cameras, USB disks, and USB printers.
3. USB Port	• USB 3.0 port for compatible USB devices, such as digital cameras, USB disks, and USB printers.
4. LAN2 LED	• Solid white: LAN2 Cable link • Blinking : Network activity
5. LAN1 LED	• Solid white: LAN1 Cable link • Blinking : Network activity
6. USB LED	• Solid white: USB busy • Solid Red: USB error
7. System LED	• Solid white: System is power on.
8. OLED	• Displays system status and information
9. System Error LED	• Blinking RED: System error.
10. Down Button	• Push to enter USB copy operation screen
11. Up Button	• Push to scroll up when using the OLED display
12. Enter Button	• Push to enter OLED operate password for basic system setting
13. Escape Button	• Push to leave the current OLED menu

N7700PRO V2/N7710 series/N7770-10G:

The Thecus N7700PRO V2/N7710 series front panel has the device's controls, indicators, and hard disk trays:

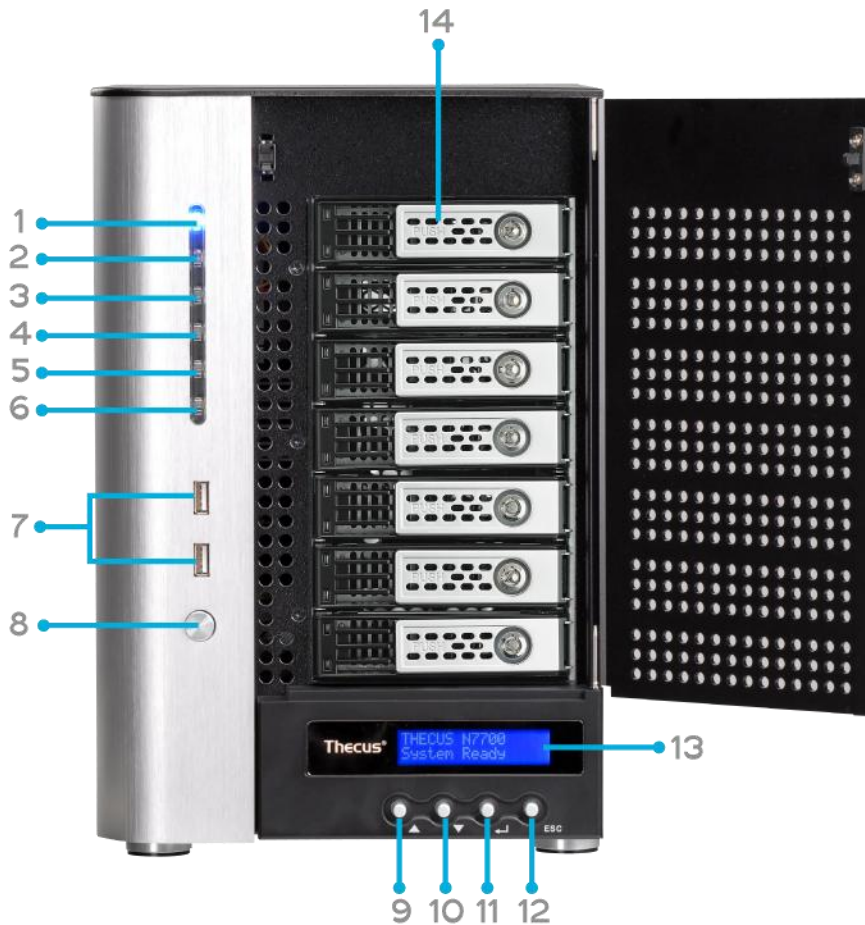

Front Panel	
Item	Description
1.Power LED	<ul style="list-style-type: none"> • Solid blue: System is power on.
2.System LED	<ul style="list-style-type: none"> • Solid orange: system is being upgraded or system startup; data currently inaccessible
3.WAN/LAN1 LED	<ul style="list-style-type: none"> • Solid green: network link • Blinking green: network activity
4.LAN2 LED	<ul style="list-style-type: none"> • Solid green: network link • Blinking green: network activity
5.USB Copy LED	<ul style="list-style-type: none"> • Solid blue: files are being copied from a USB storage device
6.eSATA link LED (N7700PROv2)	<ul style="list-style-type: none"> • Solid blue: external eSATA device has connected
7.USB Port	<ul style="list-style-type: none"> • USB 2.0 port for compatible USB devices, such as USB disks.
8.Power Button	<ul style="list-style-type: none"> • Power on/off N7700PRO V2/N7710 series/N7770-10G
9.Up Button ▲	<ul style="list-style-type: none"> • Push to scroll up when using the LCD display
10.Down Button ▼	<ul style="list-style-type: none"> • Push to enter USB copy operation screen
11.Enter Button ↵	<ul style="list-style-type: none"> • Push to enter LCD operate password for basic system setting
12.Escape Button ESC	<ul style="list-style-type: none"> • Push to leave the current LCD menu
13.LCD Display	<ul style="list-style-type: none"> • Displays current system status and warning messages
14.HDD Trays	<ul style="list-style-type: none"> • Seven 3.5" SATA HDD trays • Locks are provided for added security

N8800PRO V2/N8810U series/N8880U-10G:

The Thecus N8800PRO V2/N8810U series front panel has the device's controls, indicators, and hard disk trays:



Front Panel	
Item	Description
1.Power Button	<ul style="list-style-type: none"> Power on/off N8800PRO V2/N8810U series/N8880U-10G
2.Power LED	<ul style="list-style-type: none"> Solid green: System is power on.
3.Reboot Button	<ul style="list-style-type: none"> Press to system reboot
4.System fan alarm LED	<ul style="list-style-type: none"> Solid red: system fan failure notification
5. Mute button	<ul style="list-style-type: none"> Mute the system fan alarm.
6.USB Port	USB 2.0 port for compatible USB devices, such as USB disks, USB printers
7.Up Button ▲	<ul style="list-style-type: none"> Push to scroll up when using the LCD display
8.Down Button ▼	<ul style="list-style-type: none"> Push to enter USB copy operation screen
9.Enter Button ↵	<ul style="list-style-type: none"> Push to enter LCD operate password for basic system setting
10.Escape Button ESC	<ul style="list-style-type: none"> Push to leave the current LCD menu

N5550:

The Thecus N5550 front panel has the device's controls, indicators, and hard disk trays:



Front Panel	
Item	Description
1.System LED	<ul style="list-style-type: none"> • Blinking orange: System is being upgraded or ;is starting up; data currently inaccessible
2.WAN/LAN1 LED	<ul style="list-style-type: none"> • Solid green: Network link • Blinking green: Network activity
3.LAN2 LED	<ul style="list-style-type: none"> • Solid green: Network link • Blinking green: Network activity
4.USB Copy LED	<ul style="list-style-type: none"> • Solid blue: Files are being copied from a USB storage device
5.Syetem Warning LED	<ul style="list-style-type: none"> • Solid RED: System error
6.Reset Button	<ul style="list-style-type: none"> • Resets system configuration to default value.
7.USB Port	<ul style="list-style-type: none"> • USB 3.0 port for compatible USB devices, such as USB disks.
8.Power Button/ Power LED	<ul style="list-style-type: none"> • Power on/off N5550 and Power LED. • Solid blue: System is power on.
9.Up Button ▲	<ul style="list-style-type: none"> • Push to scroll up when using the LCD display.
10.Down Button ▼	<ul style="list-style-type: none"> • Push to enter the USB copy operation screen.
11.Enter Button ↵	<ul style="list-style-type: none"> • Push to enter LCD administrator password to access basic system setting.
12.Escape Button ESC	<ul style="list-style-type: none"> • Push to leave the current LCD menu.
13.LCD Display	<ul style="list-style-type: none"> • Displays current system status and warning messages.
14.HDD Trays	<ul style="list-style-type: none"> • Five 3.5" SATA HDD trays. • Locks are provided for added security.

N5810/N5810PRO:

The Thecus N5810/N5810PRO front panel has the device's controls, indicators, and hard disk trays:

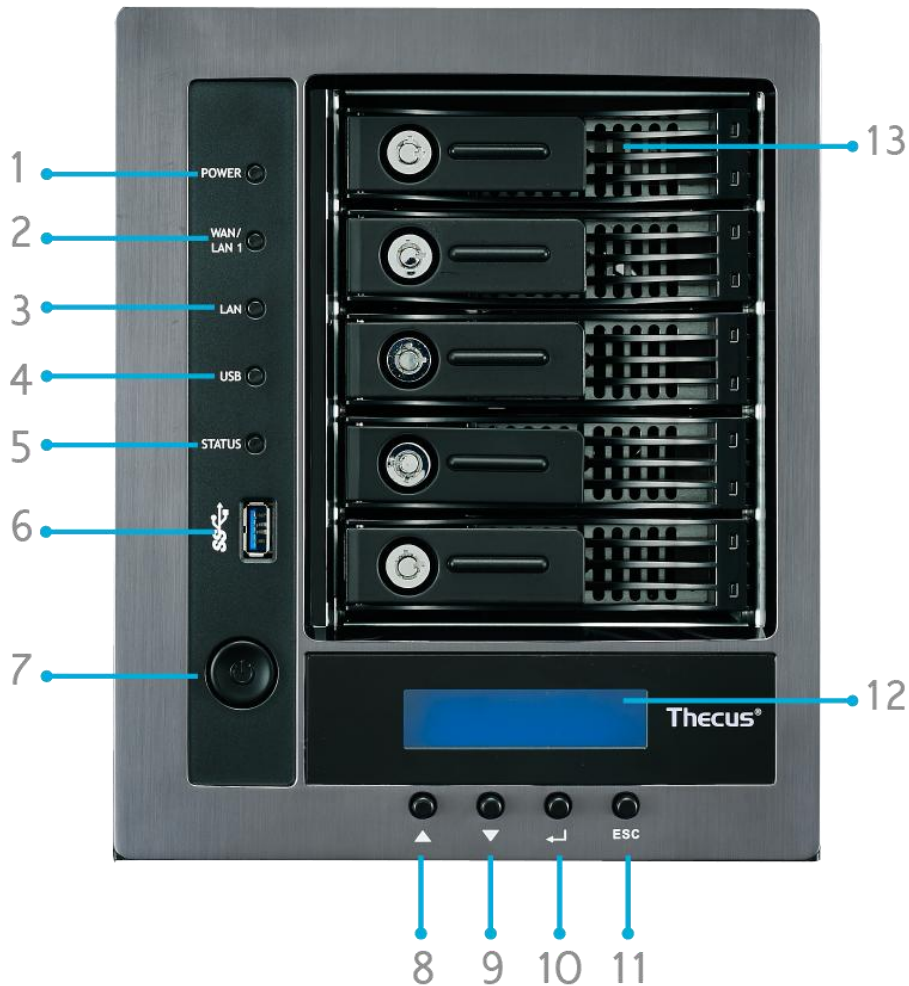

Front Panel	
Item	Description
1. Power LED	<ul style="list-style-type: none"> • White: System is power on.
2.WAN/LAN1 LED	<ul style="list-style-type: none"> • White: Network activity
3.LAN2 LED	<ul style="list-style-type: none"> • White: Network activity
4.USB Copy LED	<ul style="list-style-type: none"> • White: Files are being copied from a USB storage device • Red: USB copy error
5. System LED	<ul style="list-style-type: none"> • White: System is being upgraded or ;is starting up; data currently inaccessible • RED: System error
6.USB Port	<ul style="list-style-type: none"> • USB 3.0 port for compatible USB devices, such as USB disks.
7.Power Button	<ul style="list-style-type: none"> • Power on/off N5810/N5810PRO and Power LED.
8.Up Button ▲	<ul style="list-style-type: none"> • Push to scroll up when using the LCD display.
9.Down Button ▼	<ul style="list-style-type: none"> • Push to enter the USB copy operation screen.
10.Enter Button ↵	<ul style="list-style-type: none"> • Push to enter LCD administrator password to access basic system setting.
11.Escape Button ESC	<ul style="list-style-type: none"> • Push to leave the current LCD menu.
12.LCD Display	<ul style="list-style-type: none"> • Displays current system status and warning messages.
13.HDD Trays	<ul style="list-style-type: none"> • Five 3.5" SATA HDD trays. • Locks are provided for added security.

N4510U:

The Thecus N4510U front panel has the device's controls, indicators, and hard disk trays:

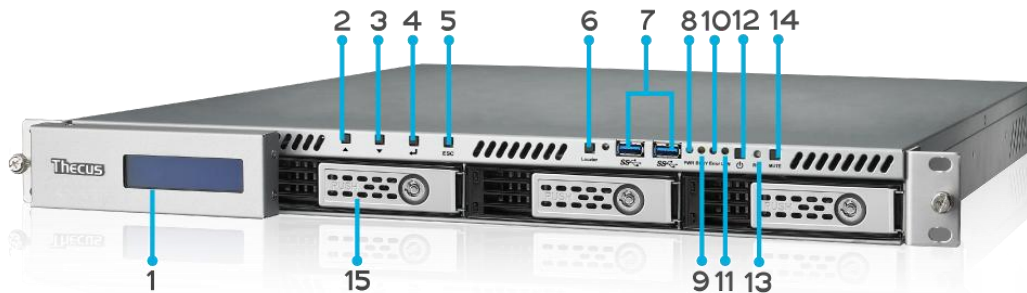

Front Panel	
Item	Description
1. LCD Display	<ul style="list-style-type: none"> Displays the current system status and warning messages. Displays hostname, WAN/LAN1/LAN2 IP addresses, RAID status, and current time.
2. Up Button ▲	<ul style="list-style-type: none"> Push to scroll up when using the LCD display.
3. Down Button ▼	<ul style="list-style-type: none"> Push to scroll down when using the LCD display.
4. Enter Button ↵	<ul style="list-style-type: none"> Push to confirm information entered into the LCD display.
5. Escape Button ESC	<ul style="list-style-type: none"> Push to leave the current LCD menu.
6. Locator Button	<ul style="list-style-type: none"> Turns on the LED backlight.
7. USB Port	<ul style="list-style-type: none"> USB 3.0 port for compatible USB devices, such as digital cameras, USB disks, and USB printers.
8. PWR LED	<ul style="list-style-type: none"> Solid Blue: System is powered on.
9. Busy LED	<ul style="list-style-type: none"> Blinking orange: system startup or system maintenance; data currently inaccessible
10. Error LED	<ul style="list-style-type: none"> Solid Red: System alert: Redundant power or system fan failure
11. LAN LED	<ul style="list-style-type: none"> Solid green: network link Blinking green: network activity
12. Power Button	<ul style="list-style-type: none"> Power the N4510U on/off.
13. Reset Button	<ul style="list-style-type: none"> Resets the N4510U.
14. Mute Button	<ul style="list-style-type: none"> Mutes the system fan alarm (Can also be managed through the UI)
15. HDD Trays	<ul style="list-style-type: none"> Four 3.5" SATA HDD trays. Locks are provided for added security.

N4510U PRO:

The Thecus N4510U PRO front panel has the device's controls, indicators, and hard disk trays:

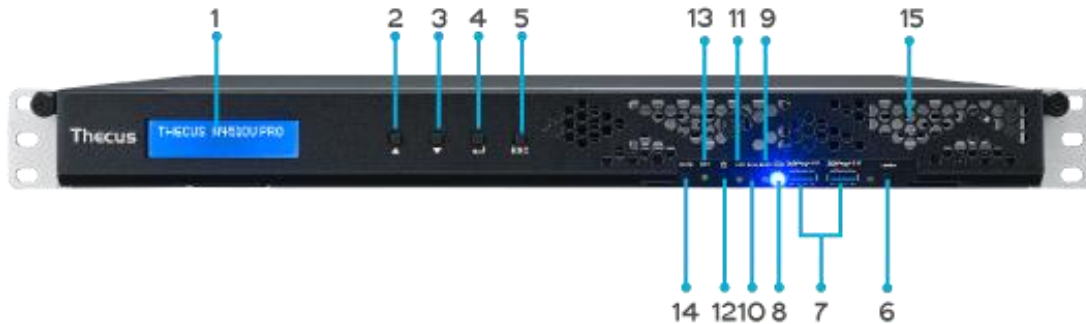

Front Panel	
Item	Description
1. LCD Display	<ul style="list-style-type: none"> Displays the current system status and warning messages. Displays hostname, WAN/LAN1 IP addresses, RAID status, and current time.
2. Up Button ▲	<ul style="list-style-type: none"> Push to scroll up when using the LCD display.
3. Down Button ▼	<ul style="list-style-type: none"> Push to scroll down when using the LCD display.
4. Enter Button ↵	<ul style="list-style-type: none"> Push to confirm information entered into the LCD display.
5. Escape Button ESC	<ul style="list-style-type: none"> Push to leave the current LCD menu.
6. Locator Button	<ul style="list-style-type: none"> Turns on the LED backlight.
7. USB Port	<ul style="list-style-type: none"> USB 3.0 port for compatible USB devices, such as digital cameras, USB disks, and USB printers.
8. PWR LED	<ul style="list-style-type: none"> Solid Blue: System is powered on.
9. Busy LED	<ul style="list-style-type: none"> Blinking orange: system startup or system maintenance; data currently inaccessible
10. Error LED	<ul style="list-style-type: none"> Solid Red: System alert: Redundant power or system fan failure
11. LAN LED	<ul style="list-style-type: none"> Solid green: network link Blinking green: network activity
12. Power Button	<ul style="list-style-type: none"> Power the N4510U PRO on/off.
13. Reset Button	<ul style="list-style-type: none"> Resets the N4510U PRO.
14. Mute Button	<ul style="list-style-type: none"> Mutes the system fan alarm (Can also be managed through the UI)
15. HDD Trays	<ul style="list-style-type: none"> Four 3.5" SATA HDD trays. Locks are provided for added security.

N7510:

The Thecus N7510 front panel has the device's controls, indicators, and hard disk trays:

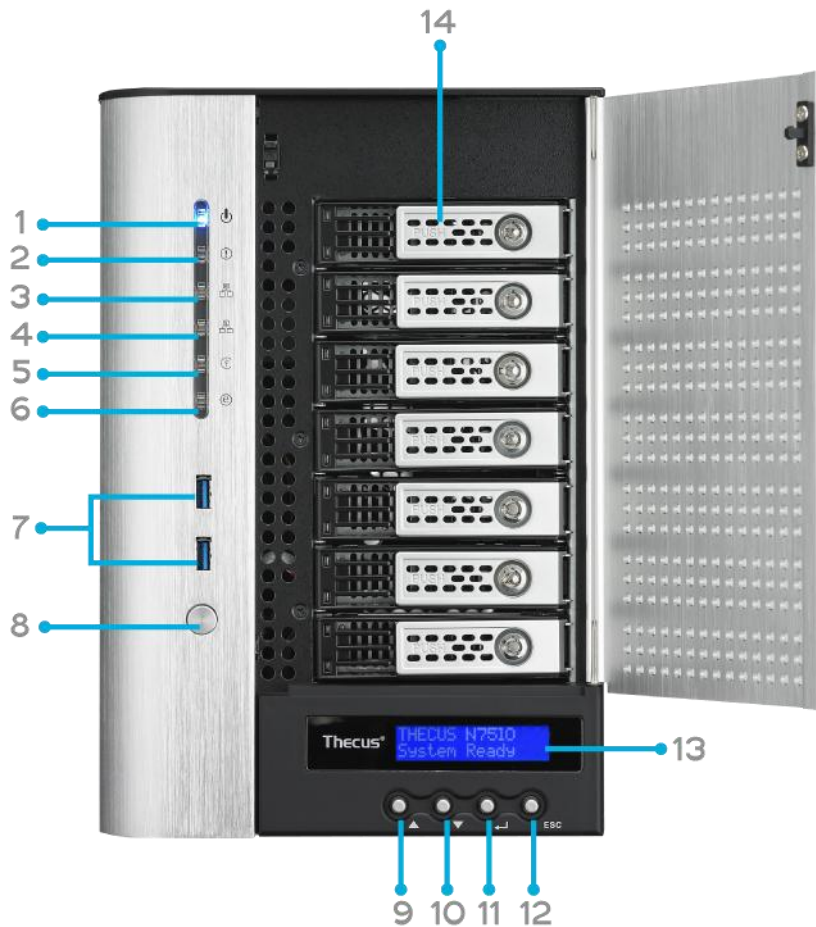

Front Panel	
Item	Description
1.Power LED	• Solid blue: System is power on.
2.System LED	• Solid orange: system is being upgraded or system startup; data currently inaccessible
3.WAN/LAN1 LED	• Solid green: network link • Blinking green: network activity
4.LAN2 LED	• Solid green: network link • Blinking green: network activity
5.USB Copy LED	• Solid blue: files are being copied from a USB storage device
6.eSATA link LED	• Solid blue: external eSATA device has connected
7.USB Port	• USB 3.0 port for compatible USB devices, such as USB disks.
8.Power Button	• Power on/off N7510
9.Up Button ▲	• Push to scroll up when using the LCD display
10.Down Button ▼	• Push to enter USB copy operation screen
11.Enter Button ↵	• Push to enter LCD operate password for basic system setting
12.Escape Button ESC	• Push to leave the current LCD menu
13.LCD Display	• Displays current system status and warning messages
14.HDD Trays	• Seven 3.5" SATA HDD trays • Locks are provided for added security

N12850:

The Thecus N12850 front panel has the device's controls, indicators, and hard disk trays:

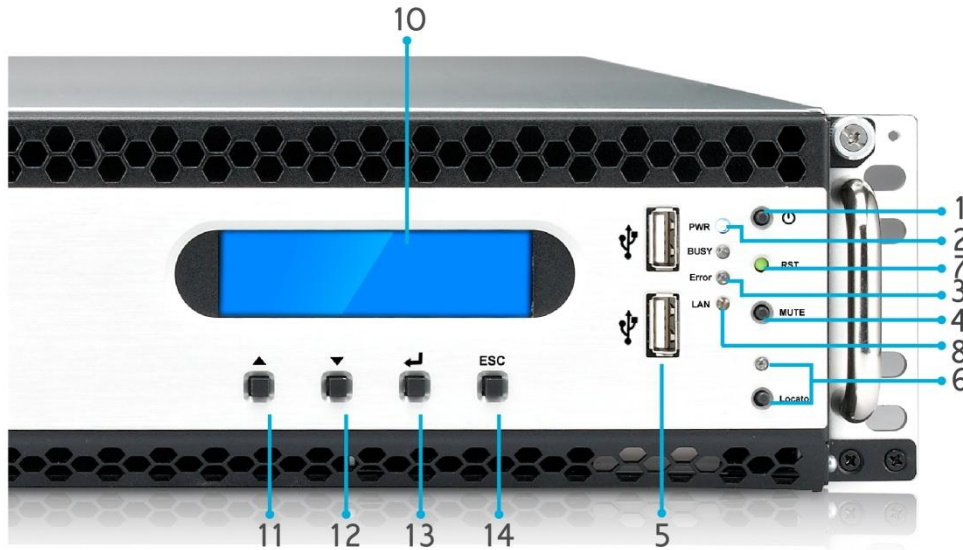

Front Panel	
Item	Description
1.Power Button	• Power on/off N12850
2.Power LED	• Solid green: System is power on.
3.System error LED	• Solid RED: System error.
4.Mute button	• Mute the system fan alarm.
5.USB Port	• USB 2.0 port for compatible USB devices, such as USB disks and USB printers
6. Locator button / LED	• Press the button, the back led will light up to identify the system position of the rack
7. RST	• Reboot system.
8. LAN	• Blinking green: network activity • Solid green: network link
9. BUSY	• Blinking orange: system startup or system maintenance; data currently inaccessible
10.LCD	• Displays current system status and messages • LCD screen saver will be enabled after screen is idle for more than 3 minutes • LCD screen will be turn off after idle for more than 6 minutes
11.Up Button ▲	• Push to scroll up when using the OLED display
12.Down Button ▼	• Push to enter USB copy operation screen
13.Enter Button ↵	• Push to enter OLED operate password for basic system setting
14.Escape Button ESC	• Push to leave the current OLED menu

N16850:

The Thecus N16850 front panel has the device's controls, indicators, and hard disk trays:

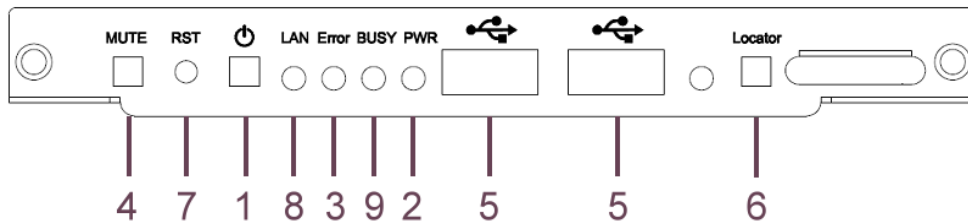
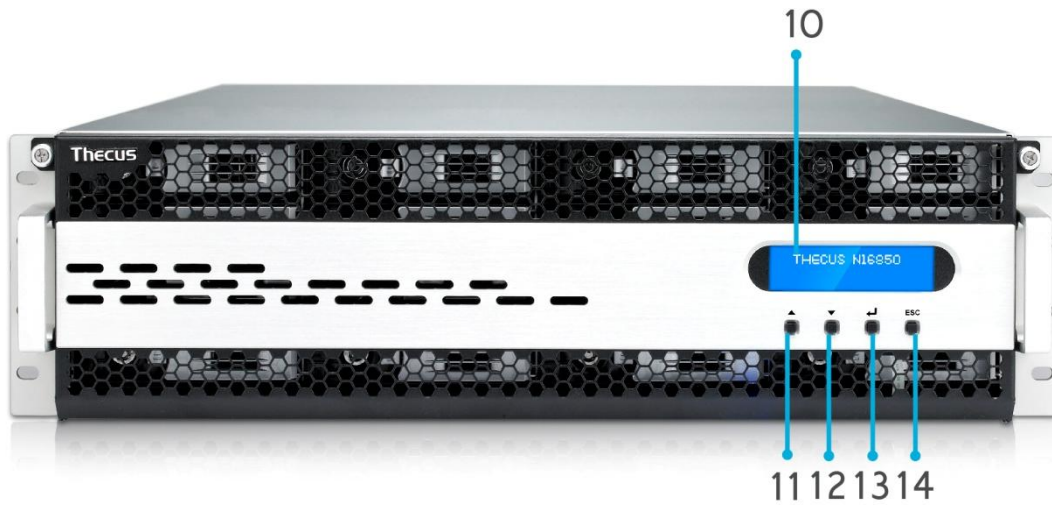

Front Panel	
Item	Description
1.Power Button	<ul style="list-style-type: none"> Power on/off N16850
2.Power LED	<ul style="list-style-type: none"> Solid green: System is power on.
3.System error LED	<ul style="list-style-type: none"> Solid RED: System error.
4.Mute button	<ul style="list-style-type: none"> Mute the system fan alarm.
5.USB Port	<ul style="list-style-type: none"> USB 2.0 port for compatible USB devices, such as USB disks and USB printers
6. Locator button / LED	<ul style="list-style-type: none"> Press the button, the back led will light up to identify the rack position of the system
7. RST	<ul style="list-style-type: none"> Reboot system.
8. LAN	<ul style="list-style-type: none"> Blinking green: network activity Solid green: network link
9. BUSY	<ul style="list-style-type: none"> Blinking orange: system startup or system maintenance; data currently inaccessible
10.LCD	<ul style="list-style-type: none"> Displays current system status and messages LCD screen saver will be enabled after screen is idle for more than 3 minutes LCD screen will be turn off after idle for more than 6 minutes
11.Up Button ▲	<ul style="list-style-type: none"> Push to scroll up when using the OLED display
12.Down Button ▼	<ul style="list-style-type: none"> Push to enter USB copy operation screen
13.Enter Button ↵	<ul style="list-style-type: none"> Push to enter OLED operate password for basic system setting
14.Escape Button ESC	<ul style="list-style-type: none"> Push to leave the current OLED menu

Rear Panel

N8900

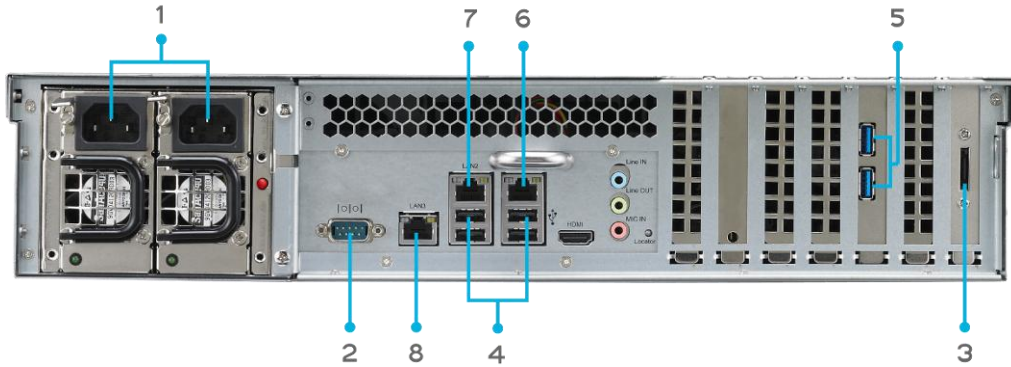

Back Panel	
Item	Description
1.Power Connector	• Connect the included power cords to these connectors
2.Serial Port	• This port is for external UPS device
3.eSATA Port	• eSATA port for high-speed storage expansion
4.USB Port	• USB 2.0 port for compatible USB devices, such as USB disks, and USB printers
5.USB Port	• USB 3.0 port for compatible USB devices.
6.WAN/LAN1 Port	• WAN/LAN1 port for connecting to an Ethernet network through a switch or router
7.LAN2 Port	• LAN2 port for connecting to an Ethernet network through a switch or router
8.LAN3 Port	• LAN3 port for connecting to an Ethernet network through a switch or router.

N12000:

The N12000 rear panel features ports and connectors.

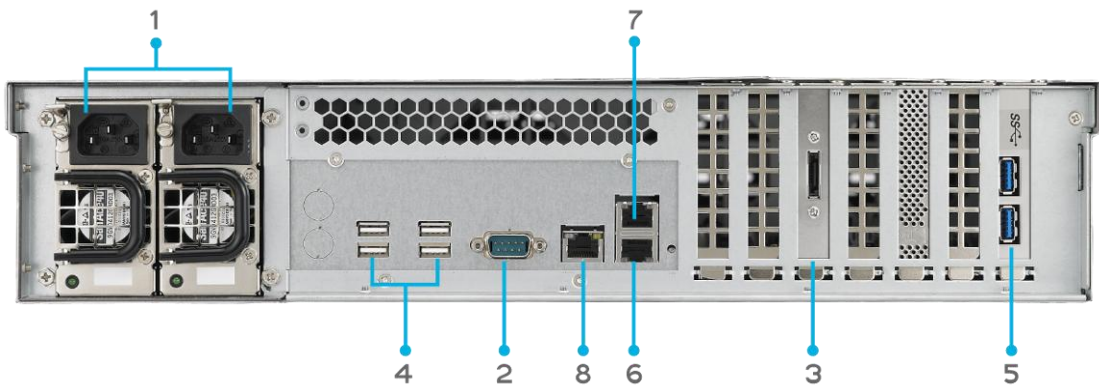

Back Panel	
Item	Description
1.Power Connector	• Connect the included power cords to these connectors
2.Serial Port	• This port is for external UPS device
3.eSATA Port	• eSATA port for high-speed storage expansion
4.USB Port	• USB 2.0 port for compatible USB devices, such as USB disks, and USB printers

5.USB Port	• USB 3.0 port for compatible USB devices.
6.WAN/LAN1 Port	• WAN/LAN1 port for connecting to an Ethernet network through a switch or router
7.LAN2 Port	• LAN2 port for connecting to an Ethernet network through a switch or router
8.LAN3 Port	• LAN3 port for HA connecting.

N12000V/N12000PRO:

N12000V/N12000PRO rear panel features ports and connectors.

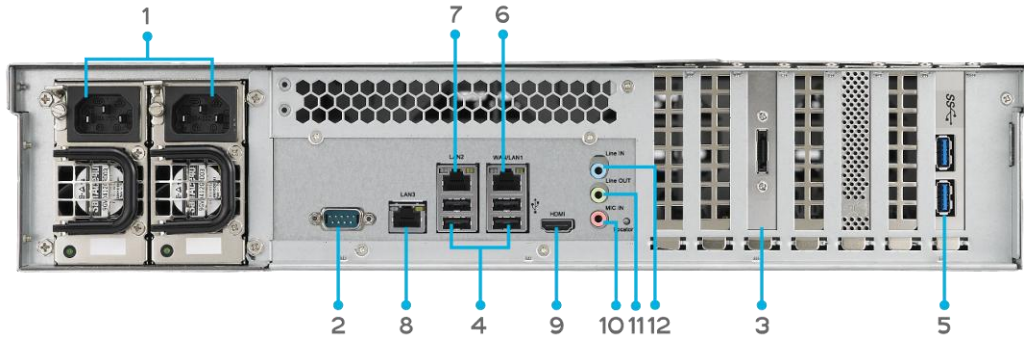

Back Panel	
Item	Description
1.Power Connector	• Connect the included power cords to these connectors
2.Serial Port	• This port is for external UPS device
3.eSATA Port	• eSATA port for high-speed storage expansion
4.USB Port	• USB 2.0 port for compatible USB devices, such as USB disks, and USB printers
5.USB Port	• USB 3.0 port for compatible USB devices.
6.WAN/LAN1 Port	• WAN/LAN1 port for connecting to an Ethernet network through a switch or router
7.LAN2 Port	• LAN2 port for connecting to an Ethernet network through a switch or router
8.LAN3 Port	• LAN3 port for HA connecting.
9.HDMI Port	• For Video/Audio out
10. Mic input	• Microphone input
11. Line out	• For Audio out
12.Line in	• For Audio in

N16000:

The N16000 rear panel features ports and connectors.

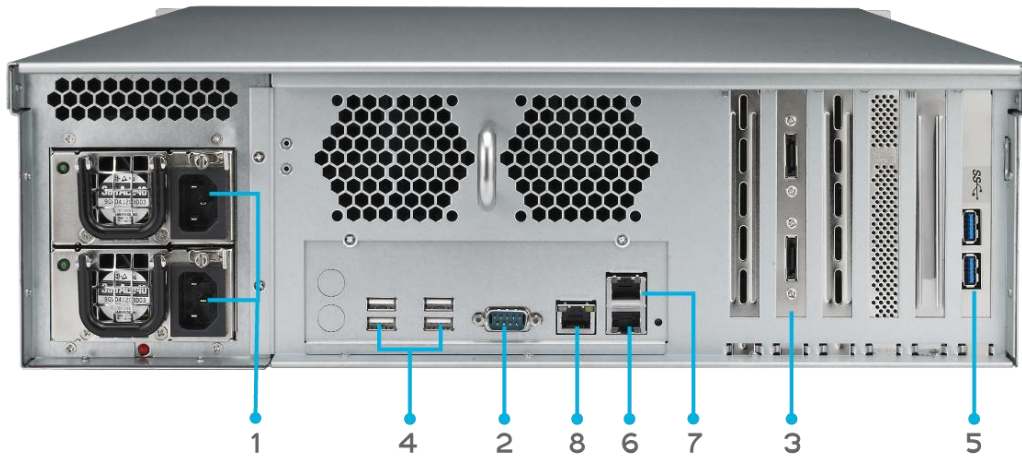

Back Panel	
Item	Description
1.Power Connector	• Connect the included power cords to these connectors
2.Serial Port	• This port is for external UPS device
3.eSATA Port	• eSATA port for high-speed storage expansion
4.USB Port	• USB 2.0 port for compatible USB devices, such as USB disks, and USB printers
5.USB Port	• USB 3.0 port for compatible USB devices.
6.WAN/LAN1 Port	• WAN/LAN1 port for connecting to an Ethernet network through a switch or router
7.LAN2 Port	• LAN2 port for connecting to an Ethernet network through a switch or router
8.LAN3 Port	• LAN3 port for HA connecting.

N16000V/N16000PRO:

N16000V/N16000PRO rear panel features ports and connectors.

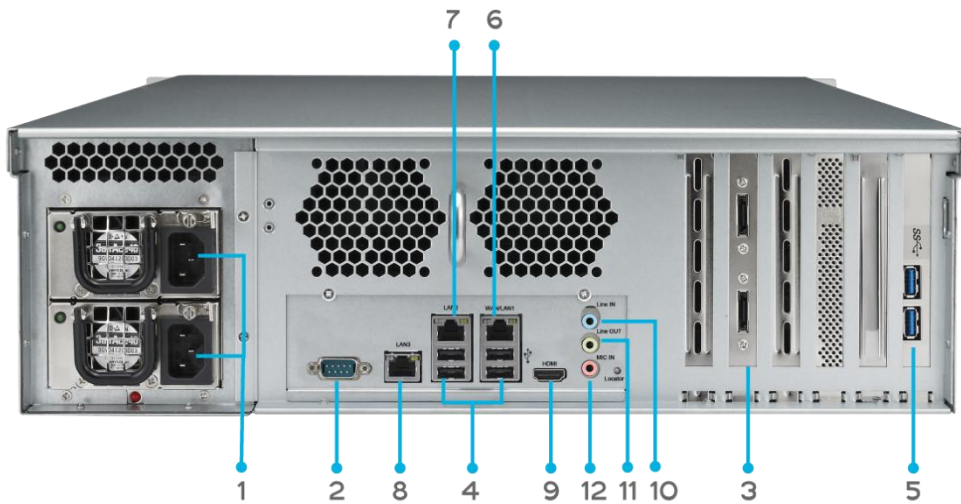

Back Panel	
Item	Description
1.Power Connector	<ul style="list-style-type: none"> • Connect the included power cords to these connectors
2.Serial Port	<ul style="list-style-type: none"> • This port is for external UPS device
3.eSATA Port	<ul style="list-style-type: none"> • eSATA port for high-speed storage expansion
4.USB Port	<ul style="list-style-type: none"> • USB 2.0 port for compatible USB devices, such as USB disks, and USB printers
5.USB Port	<ul style="list-style-type: none"> • USB 3.0 port for compatible USB devices.
6.WAN/LAN1 Port	<ul style="list-style-type: none"> • WAN/LAN1 port for connecting to an Ethernet network through a switch or router
7.LAN2 Port	<ul style="list-style-type: none"> • LAN2 port for connecting to an Ethernet network through a switch or router
8.LAN3 Port	<ul style="list-style-type: none"> • LAN3 port for HA connecting.
9.HDMI Port	<ul style="list-style-type: none"> • For Video/Audio out
10.Line in	<ul style="list-style-type: none"> • For Audio in
11. Line out	<ul style="list-style-type: none"> • For Audio out
12. Mic input	<ul style="list-style-type: none"> • Microphone input

N12850/N16850:

N12850/N16850 rear panel features ports and connectors.

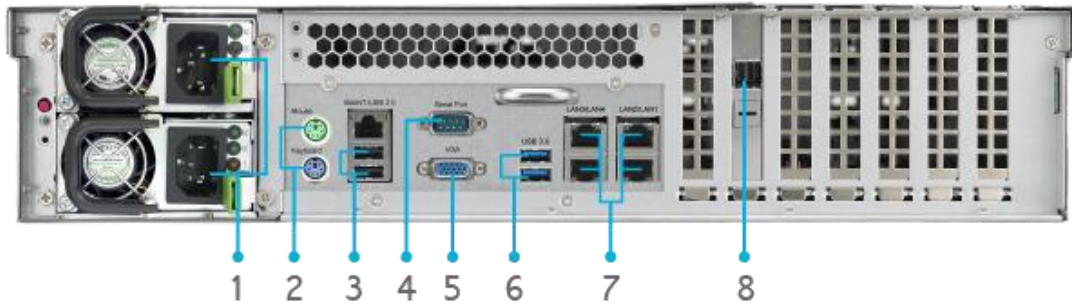

Back Panel	
Item	Description
1.Power Connector	<ul style="list-style-type: none">• Connect the included power cords to these connectors
2. PS/2 connector	<ul style="list-style-type: none">• The color-coded PS/2 connection ports (purple for keyboard and green for mouse)
3.USB Port	<ul style="list-style-type: none">• USB 2.0 port for compatible USB devices, such as USB disks, and USB printers
4.Serial Port	<ul style="list-style-type: none">• This port is for external UPS device
5.VGA Port	<ul style="list-style-type: none">• For Video out
6.USB Port	<ul style="list-style-type: none">• USB 3.0 port for compatible USB devices.
7. LAN1\LAN2\ LAN3\ LAN4 Port	<ul style="list-style-type: none">• LAN1\LAN2\ LAN3\ LAN4 port for connecting to an Ethernet network through a switch or router
8. SFF-8644 SAS Wide Port	<ul style="list-style-type: none">• Support Capacity expansion via Thecus JBOD device

N6850:

The N6850 rear panel features ports and connectors.

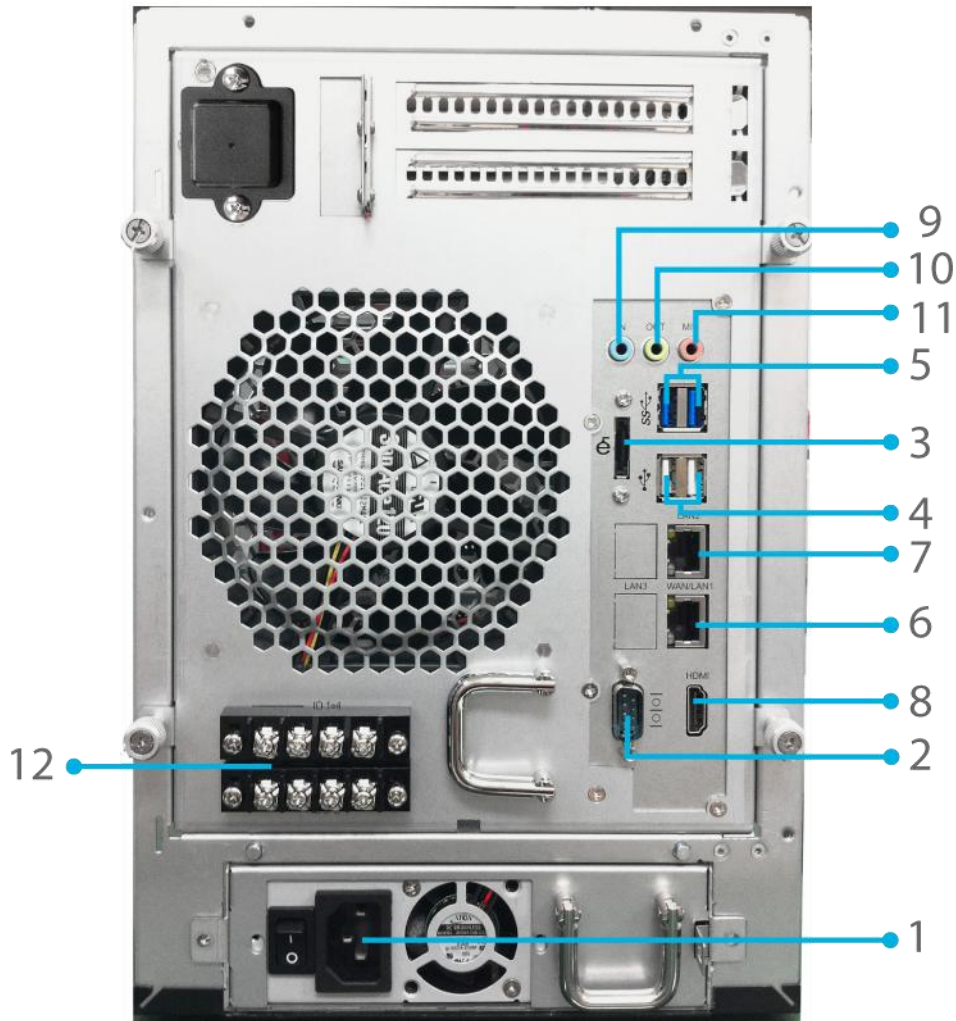

Back Panel	
Item	Description
1.Power Connector	<ul style="list-style-type: none"> • Connect the included power cords to these connectors
2.Serial Port	<ul style="list-style-type: none"> • This port is for external UPS device
3.eSATA Port	<ul style="list-style-type: none"> • eSATA port for high-speed storage expansion
4.USB Port	<ul style="list-style-type: none"> • USB 2.0 port for compatible USB devices, such as USB disks, and USB printers
5.USB Port	<ul style="list-style-type: none"> • USB 3.0 port for compatible USB devices.
6.WAN/LAN1 Port	<ul style="list-style-type: none"> • WAN/LAN1 port for connecting to an Ethernet network through a switch or router
7.LAN2 Port	<ul style="list-style-type: none"> • LAN2 port for connecting to an Ethernet network through a switch or router
8.HDMI Port	<ul style="list-style-type: none"> • For Video/Audio out
9.Line in	<ul style="list-style-type: none"> • For Audio in
10. Line out	<ul style="list-style-type: none"> • For Audio out
11. Mic input	<ul style="list-style-type: none"> • Microphone input
12. User GPIO	<ul style="list-style-type: none"> • Could define each GPIO (0~7) and implement its own functionality.

N8850:

The N8850 rear panel features ports and connectors.

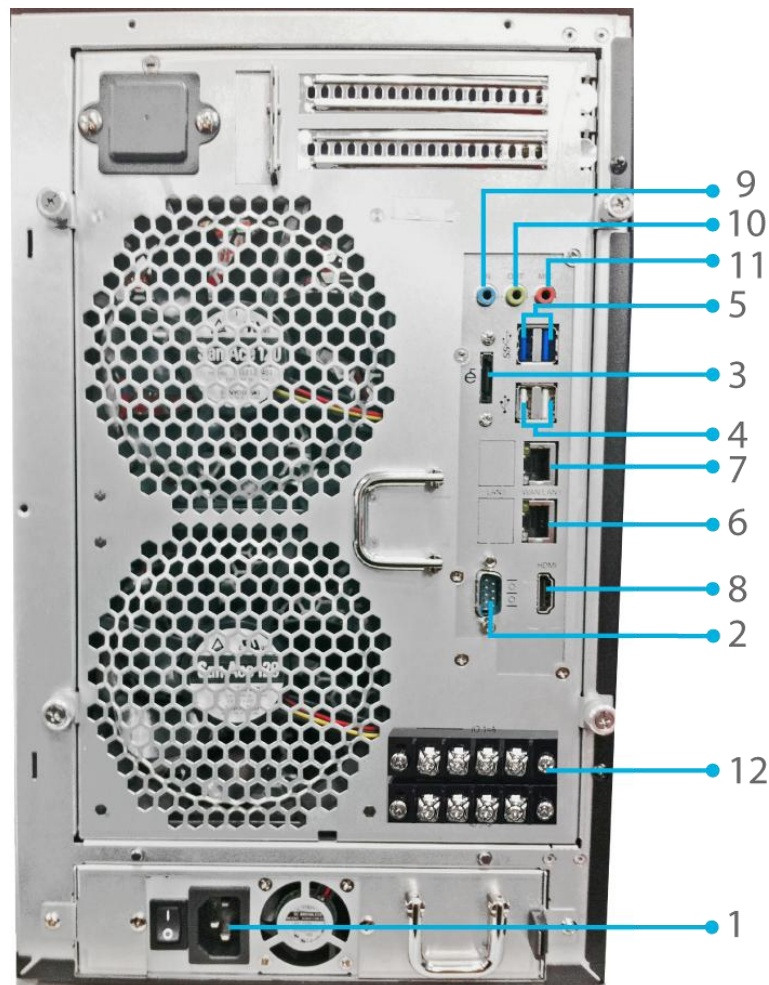

Back Panel	
Item	Description
1.Power Connector	<ul style="list-style-type: none">• Connect the included power cords to these connectors
2.Serial Port	<ul style="list-style-type: none">• This port is for external UPS device
3.eSATA Port	<ul style="list-style-type: none">• eSATA port for high-speed storage expansion
4.USB Port	<ul style="list-style-type: none">• USB 2.0 port for compatible USB devices, such as USB disks, and USB printers
5.USB Port	<ul style="list-style-type: none">• USB 3.0 port for compatible USB devices.
6.WAN/LAN1 Port	<ul style="list-style-type: none">• WAN/LAN1 port for connecting to an Ethernet network through a switch or router
7.LAN2 Port	<ul style="list-style-type: none">• LAN2 port for connecting to an Ethernet network through a switch or router
8.HDMI Port	<ul style="list-style-type: none">• For Video/Audio out
9.Line in	<ul style="list-style-type: none">• For Audio in
10. Line out	<ul style="list-style-type: none">• For Audio out
11. Mic input	<ul style="list-style-type: none">• Microphone input
12. User GPIO	<ul style="list-style-type: none">• Could define each GPIO (0~7) and implement its own functionality.

N10850:

The N10850 rear panel features ports and connectors.

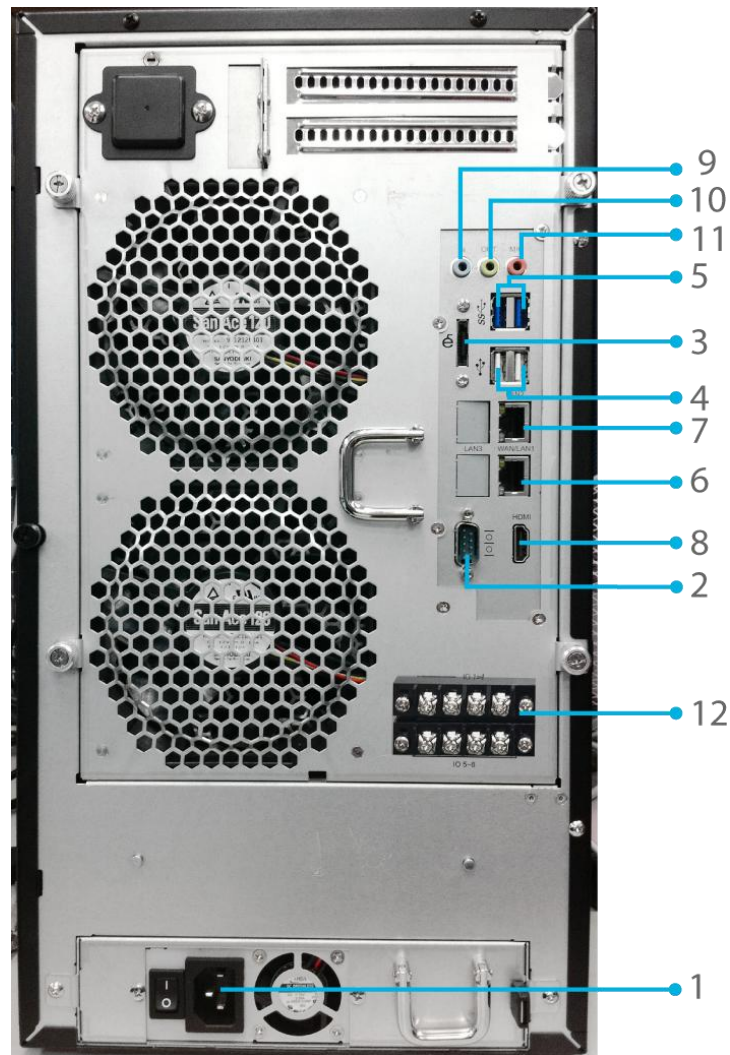

Back Panel	
Item	Description
1.Power Connector	• Connect the included power cords to these connectors
2.Serial Port	• This port is for external UPS device
3.eSATA Port	• eSATA port for high-speed storage expansion
4.USB Port	• USB 2.0 port for compatible USB devices, such as USB disks, and USB printers
5.USB Port	• USB 3.0 port for compatible USB devices.
6.WAN/LAN1 Port	• WAN/LAN1 port for connecting to an Ethernet network through a switch or router
7.LAN2 Port	• LAN2 port for connecting to an Ethernet network through a switch or router
8.HDMI Port	• For Video/Audio out
9.Line in	• For Audio in
10.Line out	• For Audio out
11.Mic input	• Microphone input
12. User GPIO	• Could define each GPIO (0~7) and implement its own functionality.

N7700PRO V2:

The N7700PRO V2 rear panel features ports and connectors.

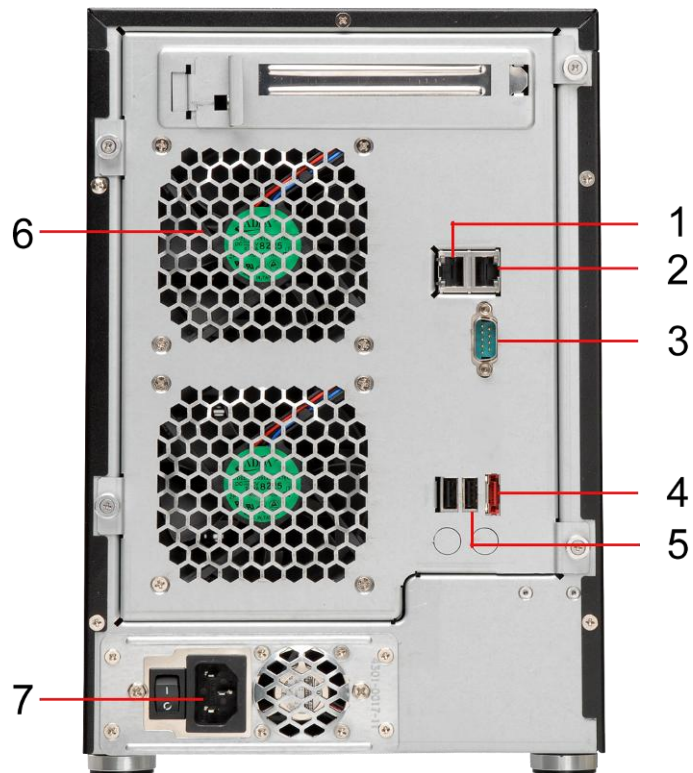

Back Panel	
Item	Description
1.LAN2 Port	• LAN2 port for connecting to a local Ethernet network through a switch or router.
2.WAN/LAN1 Port	• WAN/LAN1 port for connecting to an Ethernet network through a switch or router.
3.Serial Port	• This port is for an external UPS device.
4.eSATA Port	• eSATA port for high-speed storage expansion.
5.USB Port	• USB 2.0 port for compatible USB devices, such as USB disks, and USB printers.
6.System Fan	• System fan that exhausts heat from the unit.
7.Power Connector	• Connect the included power cord to this connector.

N7710 series/N7770-10G:

The N7710 series rear panel features ports and connectors.

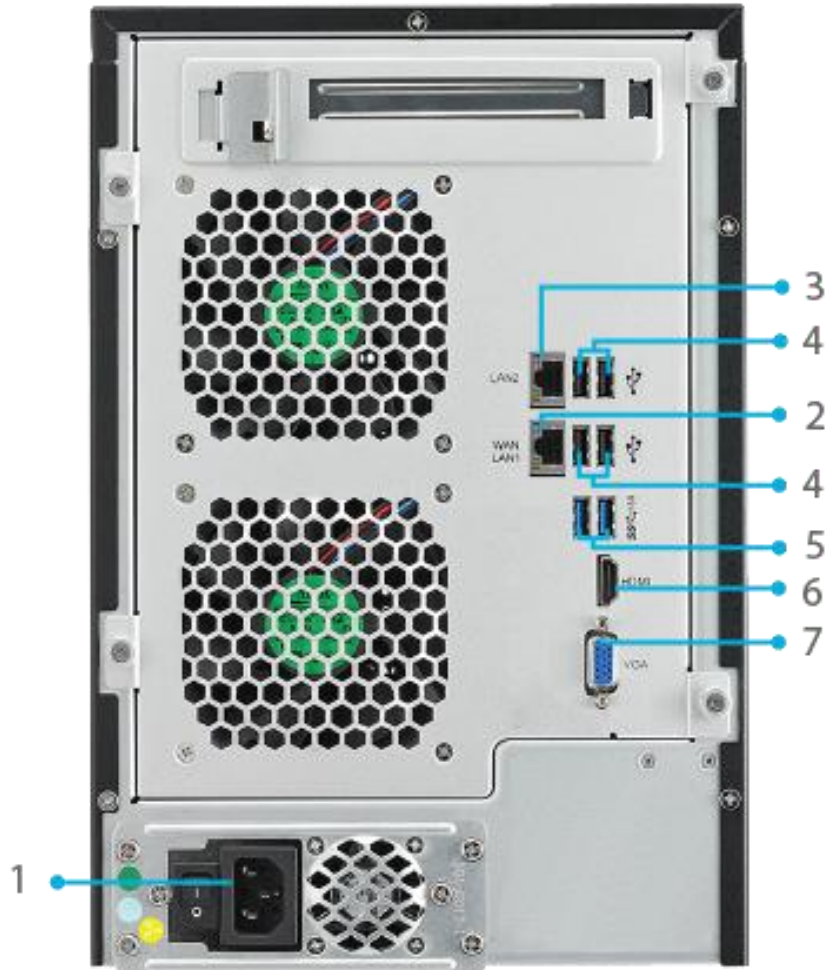

Back Panel	
Item	Description
1.Power Connector	• Connect the included power cords to these connectors
2. WAN/LAN1 Port	• WAN/LAN1 port for connecting to an Ethernet network through a switch or router
3. LAN2 Port	• LAN2 port for connecting to an Ethernet network through a switch or router
4.USB Port	• USB 2.0 port for compatible USB devices, such as USB disks, and USB printers
5.USB Port	• USB 3.0 port for compatible USB devices, such as USB disks, and USB printers
6.HDMI Port	• For Video/Audio out
7.VGA Port	• For Video out

N8800PRO V2:

The N8800PRO V2 rear panel features ports and connectors.

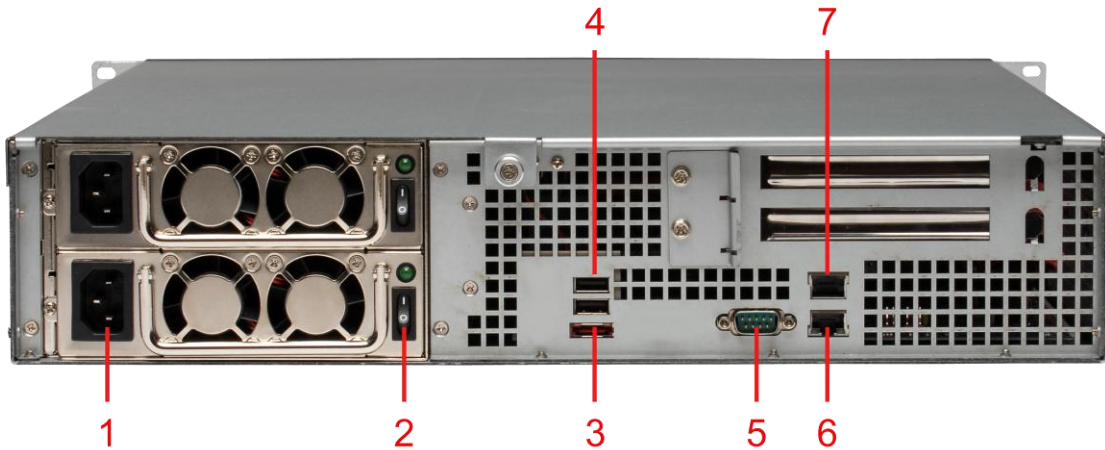

Back Panel	
Item	Description
1.Power Connector	• Connect the included power cords to these connectors
2.Power Switch	• Switch for power supply
3.eSATA Port	• eSATA port for high-speed storage expansion
4.USB Port	• USB 2.0 port for compatible USB devices, such as USB disks, and USB printers
5.Serial Port	• This port is for external UPS device
6.WAN/LAN1 Port	• WAN/LAN1 port for connecting to an Ethernet network through a switch or router
7.LAN2 Port	• WAN/LAN1 port for connecting to an Ethernet network through a switch or router

N8810U series/N8880U-10G:

The N8810U series rear panel features ports and connectors.



Back Panel	
Item	Description
1.Power Connector	• Connect the included power cords to these connectors
2. WAN/LAN1 Port	• WAN/LAN1 port for connecting to an Ethernet network through a switch or router
3. LAN2 Port	• LAN2 port for connecting to an Ethernet network through a switch or router
4.USB Port	• USB 2.0 port for compatible USB devices, such as USB disks, and USB printers
5.USB Port	• USB 3.0 port for compatible USB devices, such as USB disks, and USB printers
6.HDMI Port	• For Video/Audio out
7.VGA Port	• For Video out

N5550:

The N5550 rear panel features ports and connectors.

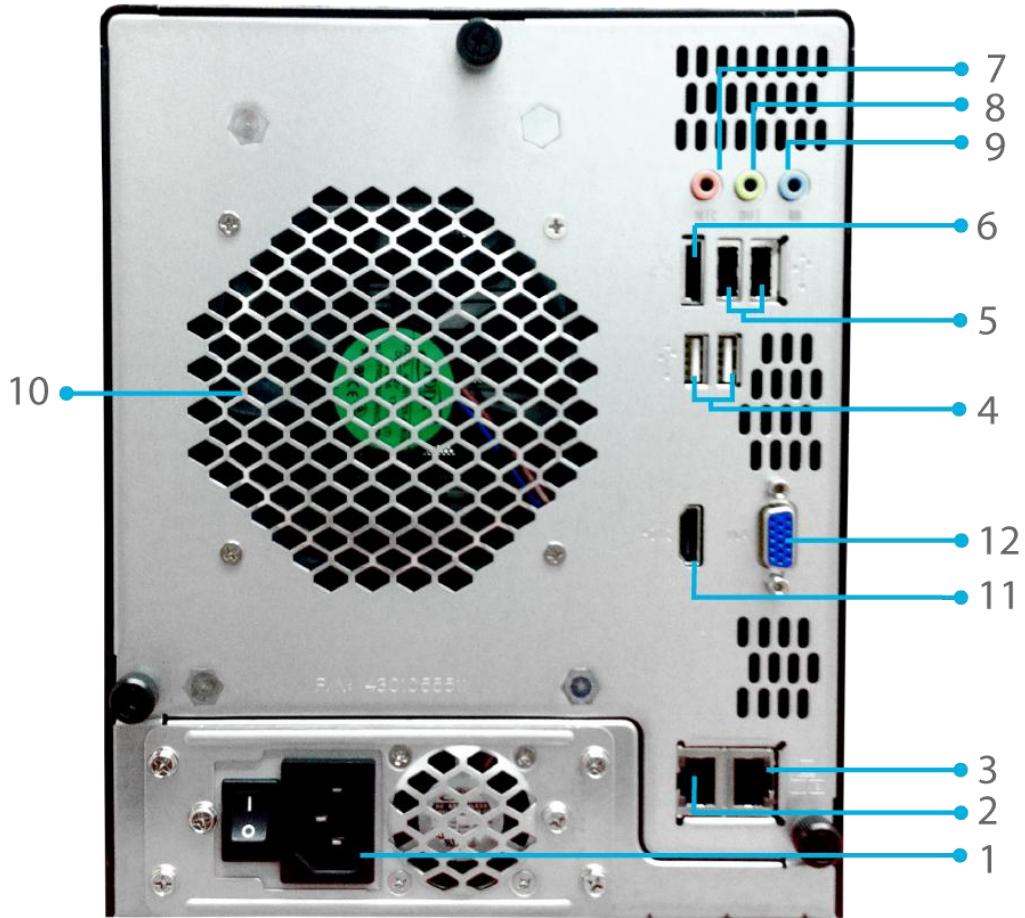

Back Panel	
Item	Description
1.Power Connector	• Connect the included power cords to these connectors
2. WAN/LAN1 Port	• WAN/LAN1 port for connecting to an Ethernet network through a switch or router
3. LAN2 Port	• LAN2 port for connecting to an Ethernet network through a switch or router
4.USB Port	• USB 2.0 port for compatible USB devices, such as USB disks, and USB printers
5.USB Port	• USB 2.0 port for compatible USB devices.
6.eSATA Port	• eSATA port for high-speed storage expansion
7.Line in	• For Audio in
8. Line out	• For Audio out
9. Mic input	• Microphone input
10.System Fan	• System fan that exhausts heat from the unit.
11.HDMI Port	• For Video/Audio out
12.VGA Port	• For Video out

N5810/N5810PRO:

The N5810/N5810PRO rear panel features ports and connectors.

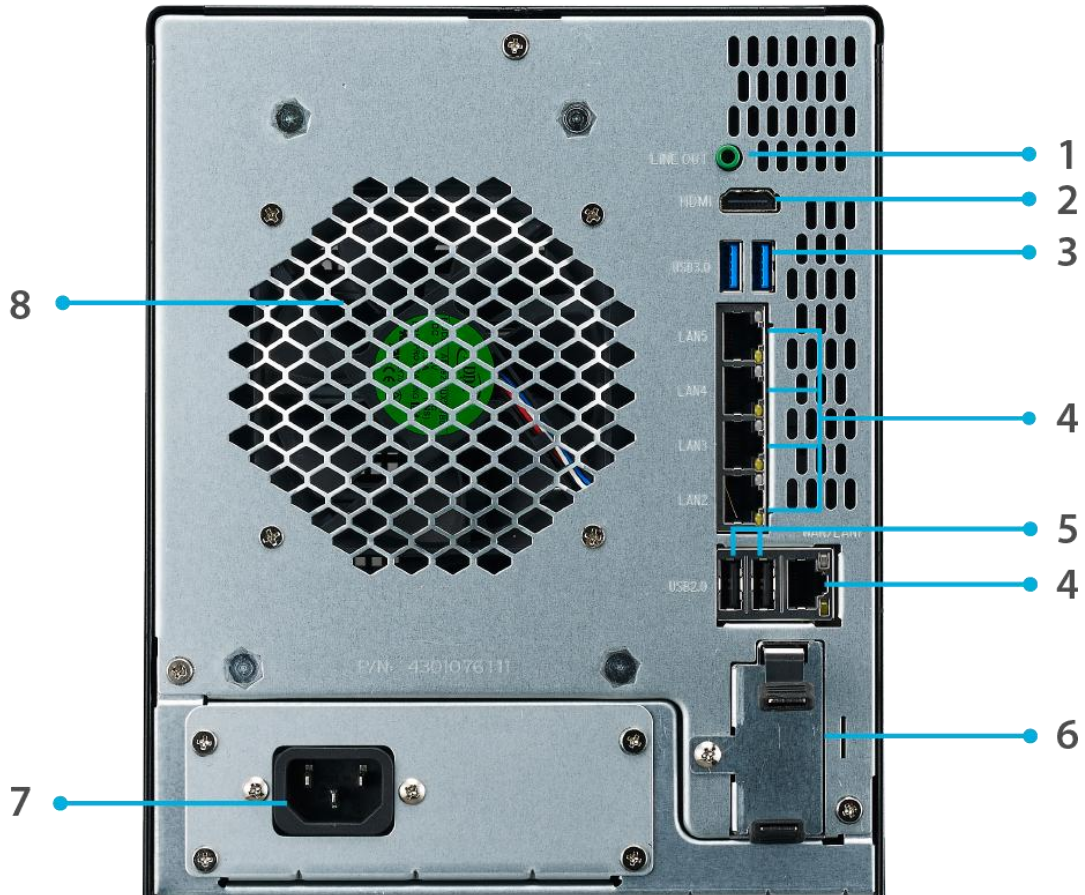

Back Panel	
Item	Description
1. Line out	• For Audio out
2.HDMI Port	• For Video/Audio out
3.USB Port	• USB 3.0 port for compatible USB devices, such as USB disks, and USB printers
4. WAN/LAN1/ LAN2/LAN3/LAN4/LAN5 Port	• WAN/LAN1/LAN2/LAN3/LAN4/LAN5 port for connecting to an Ethernet network through a switch or router
5.USB Port	• USB 2.0 port for compatible USB devices.
6.UPS Battery slot (N5810PRO)	• For UPS Battery
7.Power Connector	• Connect the included power cords to these connectors
8.System Fan	• System fan that exhausts heat from the unit.

N4510U-R:

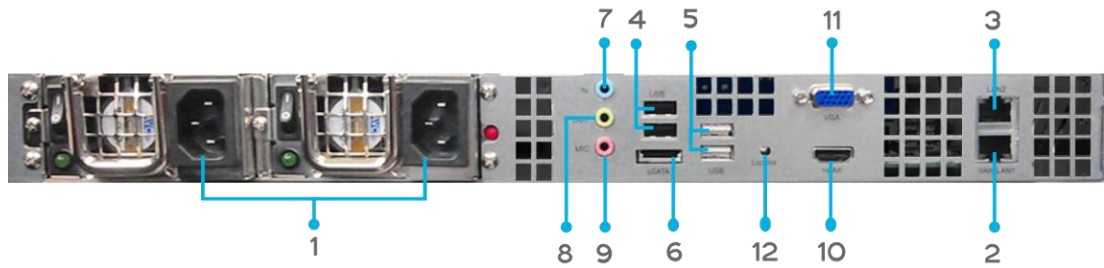

Back Panel	
Item	Description
1.Power Connector	• Connect the included power cords to these connectors
2. WAN/LAN1 Port	• WAN/LAN1 port for connecting to an Ethernet network through a switch or router
3. LAN2 Port	• LAN2 port for connecting to an Ethernet network through a switch or router
4.USB Port	• USB 2.0 port for compatible USB devices, such as USB disks, and USB printers
5.USB Port	• USB 2.0 port for compatible USB devices.
6.eSATA Port	• eSATA port for high-speed storage expansion
7.Line in	• For Audio in
8. Line out	• For Audio out
9. Mic input	• Microphone input
10.HDMI Port	• For Video/Audio out
11.VGA Port	• For Video out
12. Locator LED	• Identifies each NAS within a rack mount configuration.

N4510U-S:

The rear panel of the N4510U-S is similar to the N4510U-R, but with a single power connector:

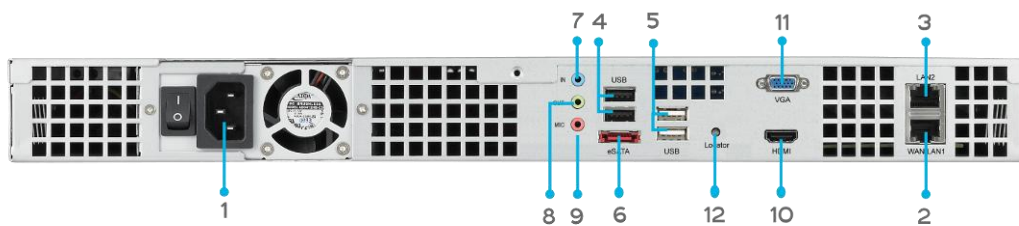

N4510U PRO-R:

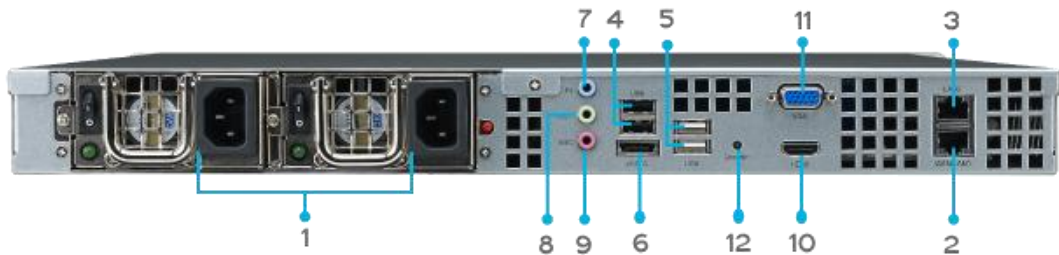

Back Panel	
Item	Description
1.Power Connector	• Connect the included power cords to these connectors
2. WAN/LAN1 Port	• WAN/LAN1 port for connecting to an Ethernet network through a switch or router
3. LAN2 Port	• LAN2 port for connecting to an Ethernet network through a switch or router
4.USB Port	• USB 2.0 port for compatible USB devices, such as USB disks, and USB printers
5.USB Port	• USB 2.0 port for compatible USB devices.
6.eSATA Port	• eSATA port for high-speed storage expansion
7.Line in	• For Audio in
8. Line out	• For Audio out
9. Mic input	• Microphone input
10.HDMI Port	• For Video/Audio out
11.VGA Port	• For Video out
12. Locator LED	• Identifies each NAS within a rack mount configuration.

N4510U PRO-S:

The rear panel of the N4510U PRO-S is similar to the N4510U PRO-R, but with a single power connector:

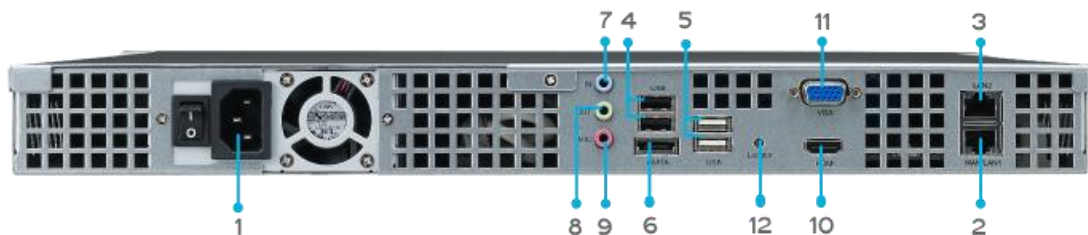

N7510:

The N7510 rear panel features ports and connectors.

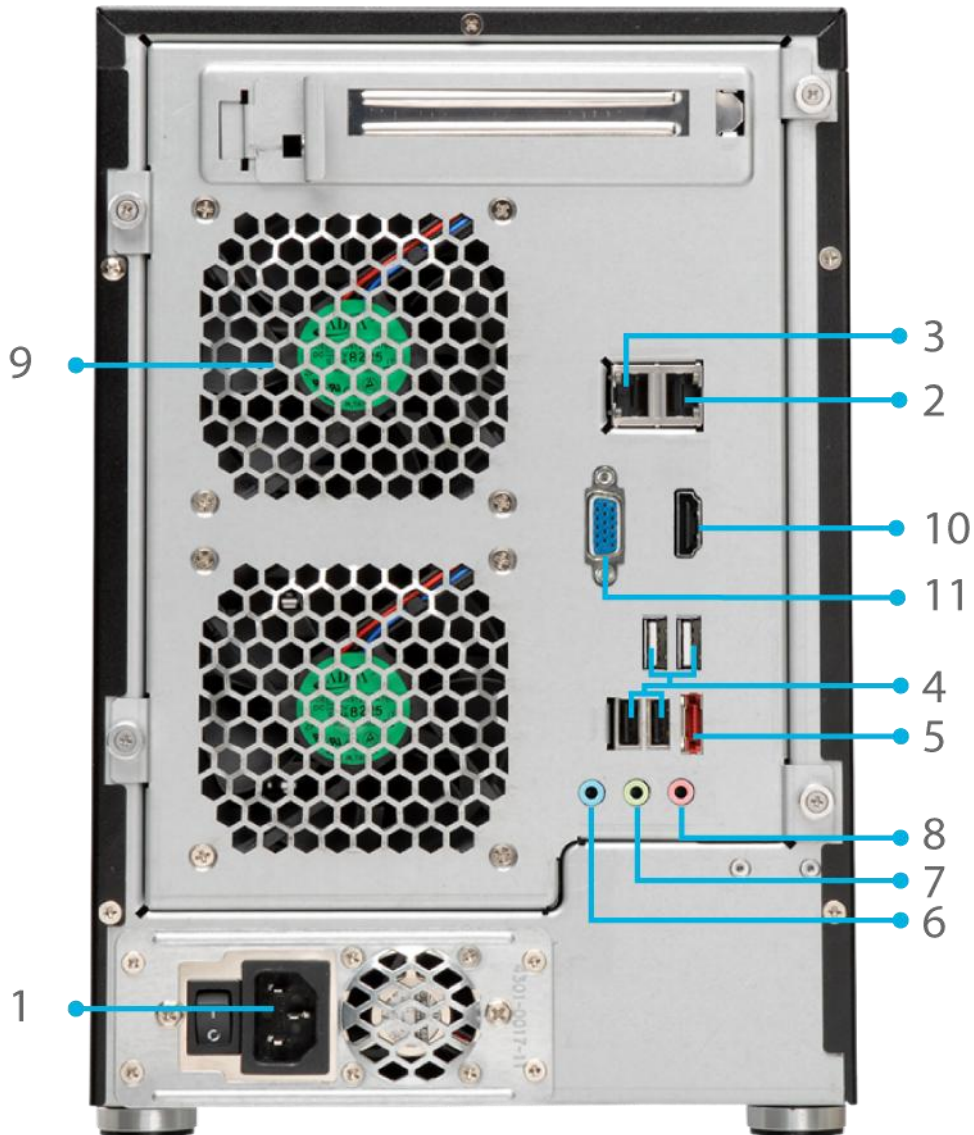

Back Panel	
Item	Description
1.Power Connector	• Connect the included power cords to these connectors
2. WAN/LAN1 Port	• WAN/LAN1 port for connecting to an Ethernet network through a switch or router
3. LAN2 Port	• LAN2 port for connecting to an Ethernet network through a switch or router
4.USB Port	• USB 2.0 port for compatible USB devices, such as USB disks, and USB printers
5.eSATA Port	• eSATA port for high-speed storage expansion
6.Line in	• For Audio in
7. Line out	• For Audio out
8. Mic input	• Microphone input
9.System Fan	• System fan that exhausts heat from the unit.
10.HDMI Port	• For Video/Audio out
11.VGA Port	• For Video out

Chapter 2: Hardware Installation

Overview

Your Thcus IP storage is designed for easy installation. To help you get started, the following chapter will help you quickly get your Thcus IP storage up and running. Please read it carefully to prevent damaging your unit during installation.

Before You Begin

Before you begin, be sure to take the following precautions:

1. Read and understand the **Safety Warnings** outlined in the beginning of the manual.
2. If possible, wear an anti-static wrist strap during installation to prevent static discharge from damaging the sensitive electronic components on the Thcus IP storage.
3. Be careful not to use magnetized screwdrivers around the Thcus IP storage's electronic components.

Cable Connections

To connect the Thcus IP storage product to your network, follow the steps below:

1. Connect an Ethernet cable from your network to the WAN/LAN1 port on the back panel of the Thcus IP storage.

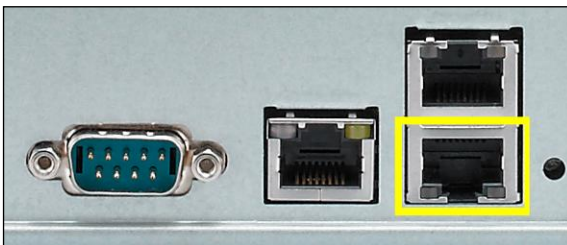

▲ N12000 series/N16000 series/N8900 series/N12850/N16850 WAN/LAN1 port

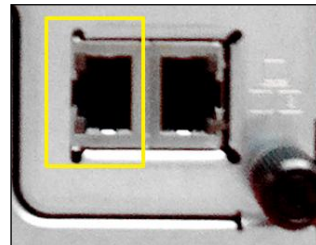

▲N5550 WAN/LAN1 port

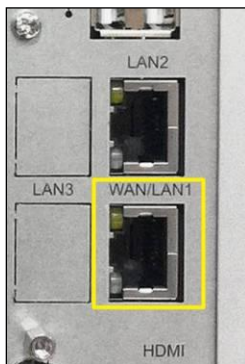

▲ N6850/N8850/N10850 WAN/LAN1 port



▲ N7700PRO V2 WAN/LAN1 port



▲ N8800PRO V2/N8810U series/N8880U-10G WAN/LAN1 port

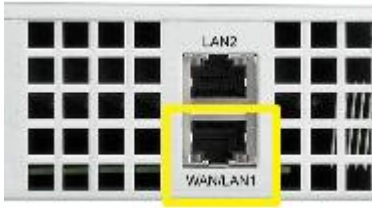

▲ N4510U/N4510U PRO
WAN/LAN1 port



▲ N7510/N7710
series/N7770-10G WAN/LAN1
port

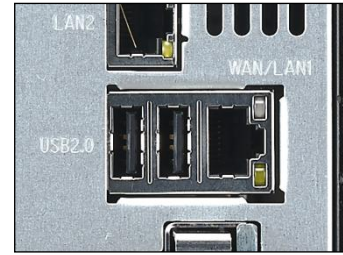

▲ N5810/N5810PRO
WAN/LAN1 port

2. Connect the provided power cord into the universal power socket on the back panel. Plug the other end of the cord into a surge protector socket.

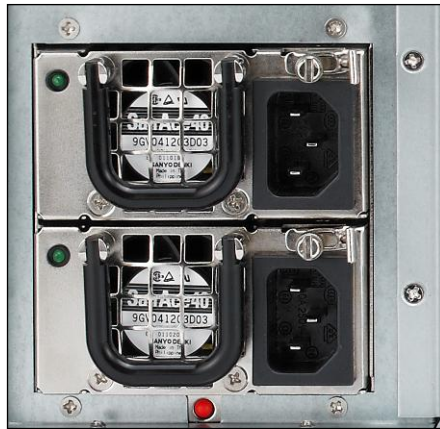

▲ N12000 series/N16000 series/N8900 series/N12850/N16850 power socket

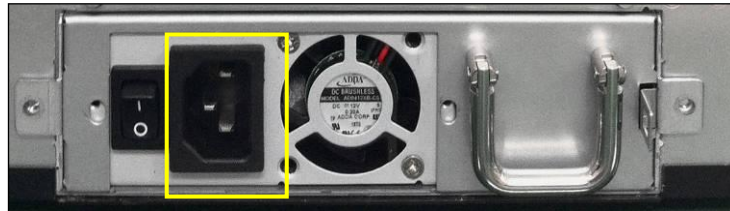

▲ N6850/N8850/N10850 power socket



▲ N7700PRO V2/N7710 series/N7510/
N7770-10G power socket



▲ N8800PRO V2/N8810U/N8880U-10G series
power socket

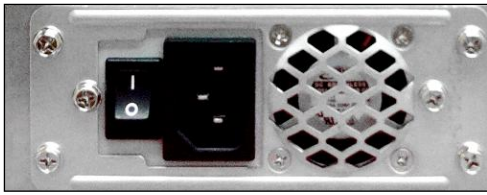

▲ N5550 power socket



▲ N4510U/N4510U PRO power socket



▲ N5810/N5810PRO power socket

3. Press the power button on the Front Panel to boot up the Thecus IP storage.

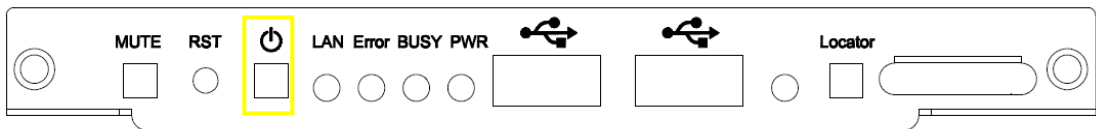

▲ N12000 series/N16000 series/N8900 series/N12850/N16850 power button



▲ N6850/N8850/N10850 power button



▲ N5550 power button



▲ N5810/N5810PRO power button



▲ N7700PRO V2/N7710 series/
N7510/N7770-10G power
button



▲ N8800PRO V2/N8810U series/N8880U-10G power button



▲ N4510U power button



▲ N4510U PRO power button

Chapter 3: First Time Setup

Overview

Once the hardware is installed, physically connected to your network, and powered on, you can configure the Thecus IP storage so that it is accessible to your network users. There are two ways to set up your Thecus IP storage: using the **Thecus Setup Wizard** or the **LCD display**. Follow the steps below for initial software setup.

Thecus Setup Wizard

The handy Thecus Setup Wizard makes configuring Thecus IP storage a snap. To configure the Thecus IP storage using the Setup Wizard, perform the following steps:

1. Insert the installation CD into your CD-ROM drive (the host PC must be connected to the network).
2. The Setup Wizard should launch automatically. If not, please browse your CD-ROM drive and double click on **Setup.exe**.



NOTE

For MAC OS X users, double click on Thecus Setup Wizard .dmg file.

3. The Setup Wizard will start and automatically detect all Thecus storage devices on your network. If none are found, please check your connection and refer to [Chapter 7: Troubleshooting](#) for assistance.

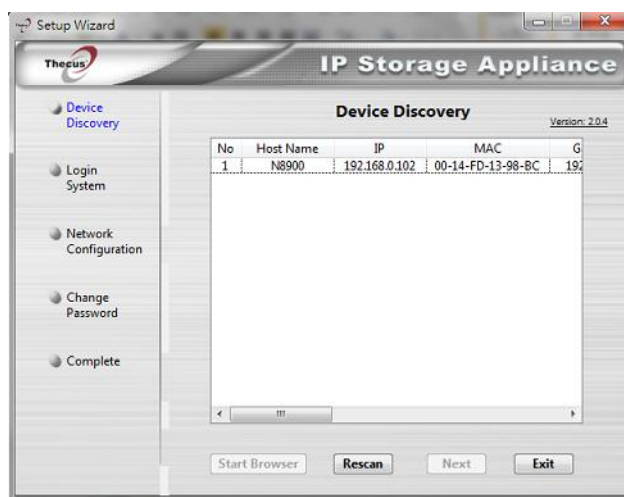

4. Select the Thecus IP storage that you like to configure.
5. Login with the administrator account and password. The default account and password are both "admin".



6. Name your Thecus IP storage and configure the network IP address. If your switch or router is configured as a DHCP Server, configuring the Thecus IP storage to automatically obtain an IP address is recommended. You may also use a static IP address and enter the DNS Server address manually.

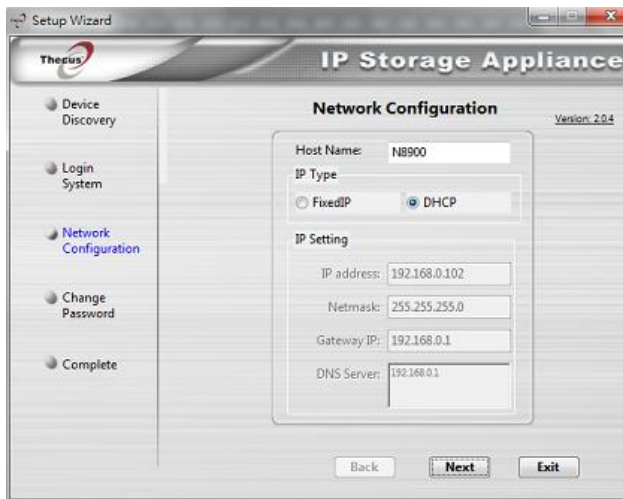

7. Change the default administrator password.



- Finished! Access the Thcus IP storage Web Administrator Interface by pressing the **Start Browser** button. You can also configure another Thcus IP storage at this point by clicking the **Setup Other Device** button. Press **Exit** to exit the wizard.



NOTE

The Thcus Setup Wizard is designed for installation on systems running Windows XP/2000/vista/7 or Mac OSX or later. Users with other operating systems will need to install the Thcus Setup Wizard on a host machine with one of these operating systems before using the unit.

LCD Operation (N7700PRO V2/N8800PRO V2/ N7710 series/N8810U series/N5550/N5810/N5810PRO/N4510U series/N7510/N7770-10G/N8880U-10G/N12850/N16850)

The mentioned models above are equipped with an LCD on the front for easy status display and setup. There are four buttons on the front panel to control the LCD functions.

LCD Controls

Use the **Up** (▲), **Down** (▼), **Enter** (↵) and **Escape** (ESC) keys to select various configuration settings and menu options for Thcus IP storage configuration.

The following table illustrates the keys on the front control panel:

LCD Controls		
Icon	Function	Description
▲	Up Button	Select the previous configuration settings option.
▼	Down Button	USB copy confirmation display.
↵	Enter	Enter the selected menu option, sub-menu, or parameter setting.
ESC	Escape	Escape and return to the previous menu.

There are two modes of operation for the LCD: **Display Mode** and **Management Mode**.

Display Mode

During normal operation, the LCD will be in **Display Mode**.

Display Mode	
Item	Description
Host Name	Current host name of the system.
WAN/LAN1	Current WAN/LAN1 IP setting.
LAN2	Current LAN2 IP setting.
Link Aggregation	Current Link Aggregation status
System Fan1	Current system fan1 status.
System Fan2	Current system fan2 status.
CPU Fan	Current CPU fan status
2009/05/22 12:00	Current system time.
Disk Info	Current status of disk slot has been installed
RAID	Current RAID status.

The Thecus IP storage will rotate these messages every one-two seconds on the LCD display.

USB Copy

The USB Copy function enables you to copy files stored on USB devices such as USB disks and digital cameras to the Thecus IP storage by press button. To use USB copy, follow the steps below:

1. Plug your USB device into an available USB port on the Front end.
2. In **Display Mode**, press the **Down Button (▼)**.
3. The LCD will display "USB Copy?"
4. Press **Enter (↵)** and the Thecus IP storage will start copying USB disks connected to the front USB port.
5. All of data will be copied into system folder named "USB copy".

Management Mode

During setup and configuration, the LCD will be in **Management Mode**.

To enter into Management Mode, press **Enter (↵)** and an "Enter Password" prompt will show on the LCD.

At this time, the administrator has to enter the correct LCD password. System will check whether the correct LCD password has been entered. The default LCD password is "0000". If correct password is entered, you will enter into the **Management Mode** menu.

Management Mode	
Item	Description
WAN/LAN1 Setting	IP address and netmask of your WAN/LAN1 ports.
LAN2 Setting	IP address and netmask of your LAN2 ports.
Link Agg. Setting	Select Load Balance , 802.3ad or Failover .
Change Admin Passwd	Change administrator's password for LCD operation.
Reset to Default	Reset system to factory defaults.
Exit	Exit Management Mode and return to Display Mode .

NOTE

You can also change your LCD password using the Web Administration Interface by navigating to **System Management > Administrator Password**. For more on the Web Administration Interface, see **Chapter 4: System Management**.

OLED Operation(Does not apply to the N7700PRO V2/N8800PRO V2/N7710 series/N8810U series/N5550/N5810/N5810PRO/N4510U series/N7510/N7770-10G/N8880U-10G)

OLED Operation

The Thecus IP storage is equipped with an OLED on the front for easy status display and setup. There are four buttons on the front panel to control the OLED functions.

OLED Controls

Use the **Up** (▲), **Down** (▼), **Enter** (↵) and **Escape** (ESC) keys to select various configuration settings and menu options for Thecus IP storage configuration.

The following table illustrates the keys on the front control panel:

OLED Controls		
Icon	Function	Description
▲	Up Button	Select the previous configuration settings option.
▼	Down Button	USB copy confirmation display.
↵	Enter	Enter the selected menu option, sub-menu, or parameter setting.
ESC	Escape	Escape and return to the previous menu.

There are two modes of operation for the OLED: **Display Mode** and **Management Mode**.

Display Mode

During normal operation, the OLED will be in **Display Mode**.

Display Mode	
Item	Description
Host Name	Current host name of the system.
WAN/LAN1	Current WAN/LAN1 IP setting.
LAN2	Current LAN2 IP setting.
Link Aggregation	Current Link Aggregation status
System Fan	Current system fan status.
CPU Fan	Current CPU fan status
2009/05/22 12:00	Current system time.
RAID	Current RAID status.

The Thecus IP storage will rotate these messages every one-two seconds on the OLED display.

USB Copy

The USB Copy function enables you to copy files stored on USB devices such as USB disks and digital cameras to the Thecus IP storage with a press of a button. To use USB copy, follow the steps below:

1. Plug your USB device into an available USB port on the Front Panel.
2. In **Display Mode**, press the **Enter** (↵).

3. The LCD will display "USB Copy?"
4. Press **Enter** (↵) and the Thecus IP storage will start copying USB disks connected to the front USB port. The LCD will display the USB copy progress and results.

Typical Setup Procedure

From the Web Administration Interface, you can begin to setup your Thecus IP storage for use on your network. Setting up the Thecus IP storage typically follows the five steps outlined below.

For more on how to use the Web Administration Interface, see **Chapter 4: Web Administration Interface**.

Step 1: Network Setup

From the Web Administration Interface, you can configure the network settings of the Thecus IP storage for your network. You can access the **Network** menu from the menu bar.

For details on how to configure your network settings, refer to **Chapter 4: System Network**.

Step 2: RAID Creation

Next, administrators can configure their preferred RAID setting and build their RAID volume. You can access RAID settings from the menu bar of the Web Administration Interface by navigating to **Storage Management > RAID Management**.

For more information on configuring RAID, see **Chapter 4: Storage > RAID Management**.

Don't know which RAID level to use? Find out more about the different RAID levels from **Appendix B: RAID Basics**.

Step 3: Create Local Users or Setup Authentication

Once the RAID is ready, you can begin to create local users for Thecus IP storage, or choose to setup authentication protocols such as Active Directory (AD).

For more on managing users, go to **Chapter 4: User and Group Authentication**.

For more information on configuring Active Directory, see **Chapter 4: User and Group Authentication > ADS Support**.

For information about the benefits of Active Directory, see **Appendix D: Active Directory Basics**.

Step 4: Create Folders and Set Up ACLs

Once users are introduced into your network, you can begin to create various folders on the Thecus IP storage and control user access to each using Folder Access Control Lists.

More information on managing folders, see **Chapter 4: Storage Management > Share Folder**.

To find out about configuring Folder Access Control Lists, see **Chapter 4: Storage Management > Share Folder> Folder Access Control List (ACL)**.

Step 5: Start Services

Finally, you can start to setup the different services of Thecus IP storage for the users on your network. You can find out more about each of these services by clicking below:

[SMB/CIFS](#)

[Apple File Protocol \(AFP\)](#)

[Network File System \(NFS\)](#)

[File Transfer Protocol \(FTP\)](#)

[iTunes Server](#)

[Printer Server](#)

Chapter 4: System Administration

Overview

The Thecus IP storage provides an easily accessible **Web Administration Interface**. With it, you can configure and monitor the Thecus IP storage anywhere on the network.

Web Administration Interface

Make sure your network is connected to the Internet. To access Thecus IP storage **Web Administration Interface**:

1. Type the Thecus IP storage IP address into your browser. (Default IP address is `http://192.168.1.100`)

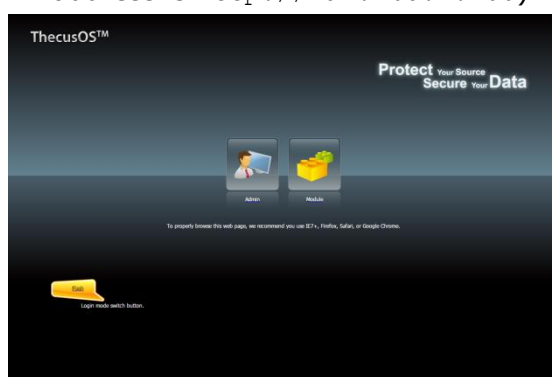

NOTE

Your computer's network IP address must be on the same subnet as the Thecus IP storage. If the Thecus IP storage has default IP address of 192.168.1.100, your managing PC IP address must be 192.168.1.x, where x is a number between 1 and 254, but not 100.

2. Login to the system using the administrator user name and password. The factory defaults are:

User Name: admin

Password: admin

- ※ If you changed your password in the setup wizard, use the new password.

Once you are logged in as an administrator, the disclaimer page will appear as below. Please click the check box if you do not want to have this page displayed during the next login.

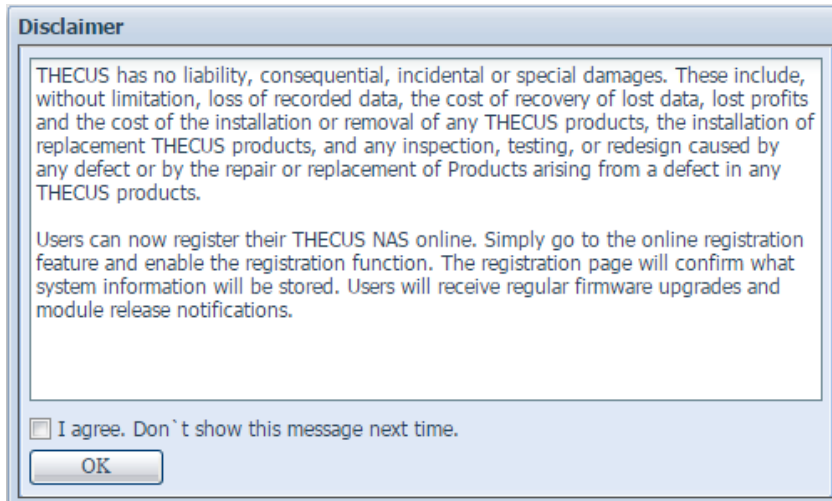

Following the disclaimer page, you will see the **Web Administration Interface**. From here, you can configure and monitor virtually every aspect of the Thecus IP storage from anywhere on the network.

My Favorite

The user interface with "My Favorite" shortcut allows the user to designate often used items and have them display on the main screen area. The figure below displays system favorite functions.

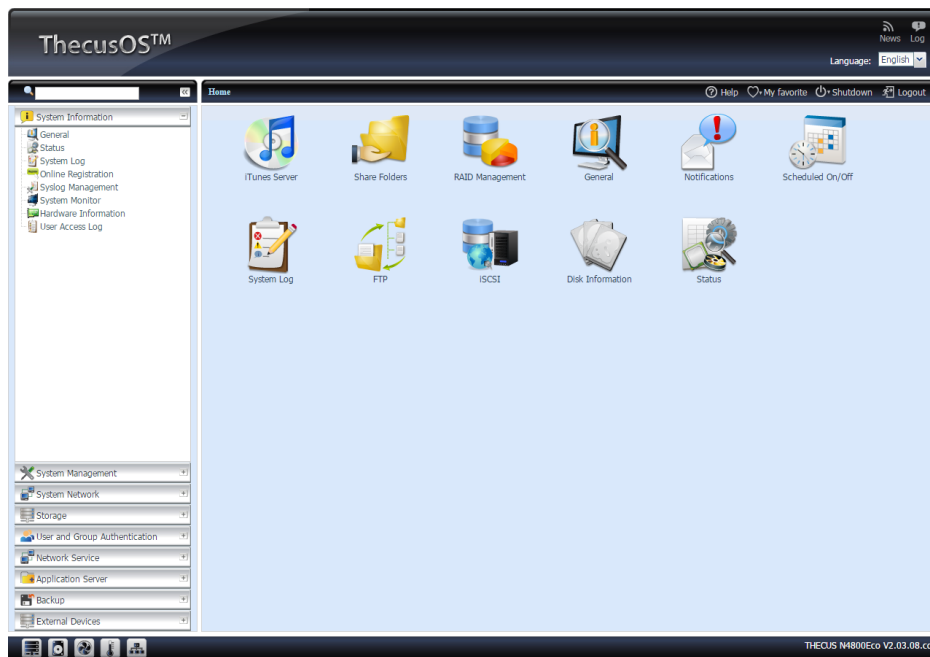

Administrators can add or remove favorite functions to My Favorites by right clicking the mouse on the menu tree.

Another way the administrators can add favorite functions is by clicking the "Add Favorite" icon in each function screen. See the figure below with the red circled icon.



To return to the favorite screen, simply click "Home" located at the left hand corner of the main screen.



Menu Bar

The **Menu Bar** is where you will find all of the information screens and system settings of Thecus IP storage. The various settings are placed in the following groups on the menu bar:



Menu Bar	
Item	Description
System Information	Current system status of the Thecus IP storage.
System Management	Various Thecus IP storage system settings and information.
System Network	Information and settings for network connections, as well as various services of the Thecus IP storage.
Storage	Information and settings for storage devices installed into the Thecus IP storage.
User and Group Authentication	Allows configuration of users and groups.
Network Service	Use the Network Service menu to make network service support settings.
Application Server	App and iTunes Server set-up of the Thecus IP storage.
Backup	Category of Backup Features setup of the Thecus IP storage.
External Devices	The Thecus IP storage supports printer server and UPS via USB interface.





Moving your cursor over any of these items will display the dropdown menu selections for each group.

In the following sections, you will find detailed explanations of each function, and how to configure your Thecus IP storage.

Message Bar

You can get quick information about your system status by moving your mouse over these icons.



Message Bar		
Item	Status	Description
	RAID Information.	Display the status of created RAID volume. Click to go to RAID information page as short cut.
	Disks Information.	Display the status of disks installed in the system. Click to go to Disk information page as short cut.
	FAN.	Display system FAN Status. Click to go to System Status page as short cut.
	Temperature	Display system temperature, click to go to System Status page as shot cut.
	Network.	Green: Connection to the network is normal. Red: abnormal connection to the network

Logout

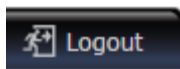

Click to logout Web Administration Interface.

Language Selection

The Thecus IP storage supports multiple Languages,

- English
- Japanese
- Traditional Chinese
- Simplified Chinese
- French
- German
- Italian
- Korean
- Spanish
- Turkish
- Russian
- Polish
- Portuguese
- Czech

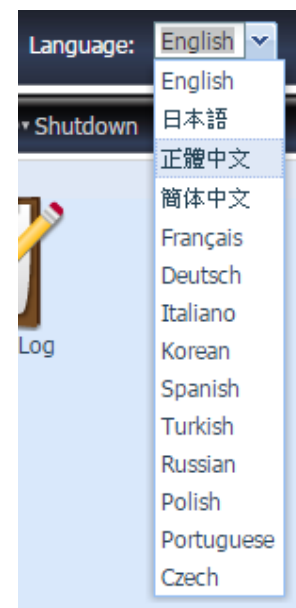

On the menu bar, click **Language** and the **selection** list appears. This user interface will switch to the selected language for Thecus IP storage.

System Information

Information provides viewing on current Product info, System Status, Service Status and Logs.

The menu bar allows you to see various aspects of the Thecus IP storage. From here, you can discover the status of the Thecus IP storage, and also other details.

General

Once you login, you will first see the basic **system Information** screen providing **Manufacturer, Product No., Firmware Version, and System Up Time** information.

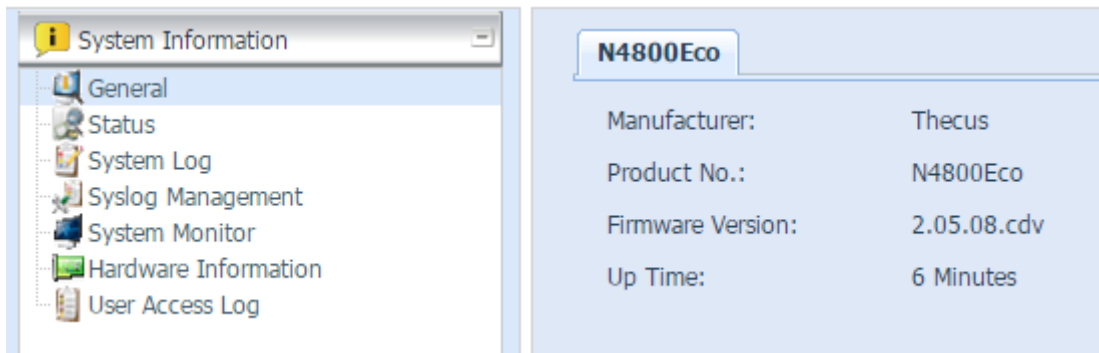

System Information	
Item	Description
Manufacturer	Displays the name of the system manufacturer.
Product No.	Shows the model number of the system.
Firmware version	Shows the current firmware version.
Up time	Displays the total run time of the system.

The Thecus N8900/N12000/N16000/N12850/N16850 series are supporting the addition of the JBOD device Thecus D16000 to expand storage capacity. From **General** in **System Information**, JBOD device info will be displayed if applicable.

N8900	D16000 - 4	N8900	D16000 - 4
Manufacturer:	Thecus	Manufacturer:	Thecus
Product No.:	N8900	Product No.:	D16000
Firmware Version:	2.03.01	Firmware Version:	109D
Up Time:	16 hours 19 minutes	Position:	4

Status

From the **System Information** menu, choose the **Status** item, **System Service Status** and **HW Status** screens appear. These screens provide basic system and service status information.

Logs

From the **System Information** menu, choose the **System Logs** option and the **System Logs** screen will appear. This screen shows a history of system usage and important events such as disk status, network information, and system booting.

Logs	
Item	Description
Number of records to export	This can be selected from a dropdown list to export the log(s) as a single file.
Export log option	This can be set to Auto Export or Auto Delete.
Log Type	The default logs displayed are for system events. From the dropdown list, administrators can choose from various forms

	of user access, such as AFP, Samba, etc. Note: Users need to enable the "User Access Log" service to view these details.
Log Level	ALL: Provides all log information including system, warning, and error messages. INFO: Shows information about system messages. WARNING: Shows only warning messages. ERROR: Shows only error messages.
Export Records	Export all logs to an external file.
Delete Records	Clear all log files.
Auto Refresh	Specify the auto refresh time interval.
The number of lines per page	Specify the desired number of lines to display per page.
Sort Ascending	Shows logs by date in ascending order.
Sort Descending	Shows logs by date in descending order.
<< < > >>	Use the forward (> >>) and backward (<< <) buttons to browse through the log pages.
	Reload logs.

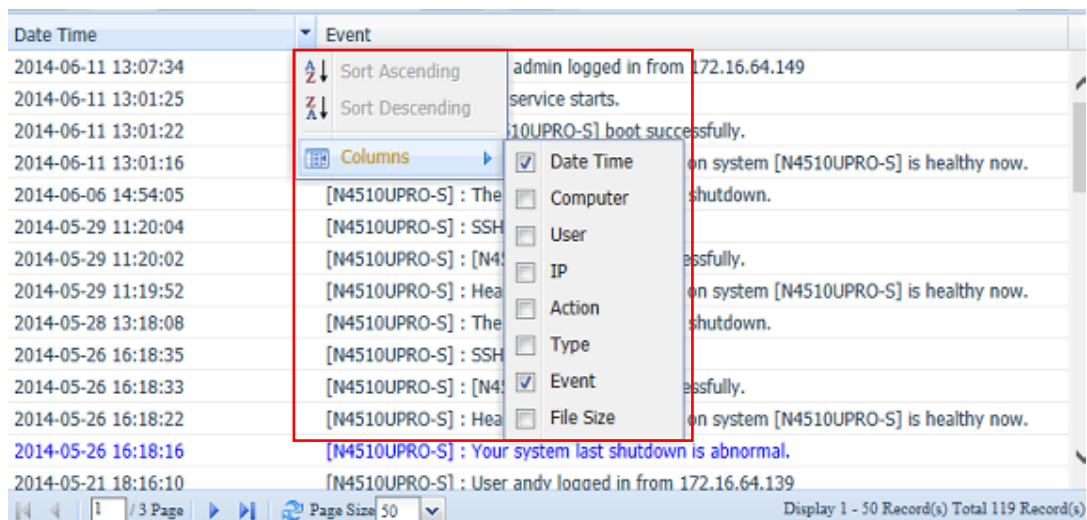

Columns can also be added to display additional information about each event.

Syslog Management

Generates system log to be stored locally or remotely, it also can be chose to act as syslog server for all other devices.

These messages are stored on your NAS in: Nsync > log> messages.

Information can be obtained in two ways: locally and remotely.

Configuration with syslog server:

The screenshot shows the Syslog Management configuration window. The 'Syslog Daemon' is set to 'Enable'. The 'Syslog service' is set to 'server'. The 'Target' is set to 'Local'. The 'Syslog folder' is set to 'NAS_Public'. The 'Log Level' is set to 'All'. The 'Remote IP Address' is set to '172.16.65.147'. An 'Apply' button is visible at the bottom.

Configuration with syslog client and target to store locally:

The screenshot shows the Syslog Management configuration window. The 'Syslog Daemon' is set to 'Enable'. The 'Syslog service' is set to 'client'. The 'Target' is set to 'Local'. The 'Syslog folder' is set to 'NAS_Public'. The 'Log Level' is set to 'All'. The 'Remote IP Address' is set to '172.16.65.147'. An 'Apply' button is visible at the bottom.

Configuration with syslog client and target to store remotely:

The screenshot shows the Syslog Management configuration window. The 'Syslog Daemon' is set to 'Enable'. The 'Syslog service' is set to 'client'. The 'Target' is set to 'Remote'. The 'Syslog folder' is set to 'NAS_Public'. The 'Log Level' is set to 'All'. The 'Remote IP Address' is set to '172.16.65.147'. An 'Apply' button is visible at the bottom.

See the following table for a detailed description of each item:

Time	
Item	Description
Syslog Daemon	Enable/Disable syslog daemon.
Syslog service	If Server has been selected then associated syslog folder will be used to store all system logs from other NAS devices which has

	assigned this system for syslog server as well as syslog of this server unit. It can be seen from associated syslog folder with files "error", "Information" and "warning". If client has been selected then "Local" or "Remotely" can be choose.
Target	Choose Local, all system logs will be stored in an associated syslog folder filled in from next filed. And the syslog folder will have file "messages" to store all system logs. If Remotely has been selected, a syslog server is needed and an IP address is required.
Syslog folder	Select from a drop down share list, all of the system logs will be stored on it. This syslog folder is applied to "syslog server" or "syslog client" with "local" selected.
Log Level	The user can choose from 3 different levels. "All", "Warning/Error" or "Error".
Remote IP Address	Input the syslog server IP address if choose to store syslog info remotely.

System Monitor

The system monitor is capable to monitor system status including CPU/memory utilization, fan/temperature status, network throughput and on-line user list in various protocols.

To monitor system status, simply click on "System Monitor" from the tree menu and the screen will appear as below.

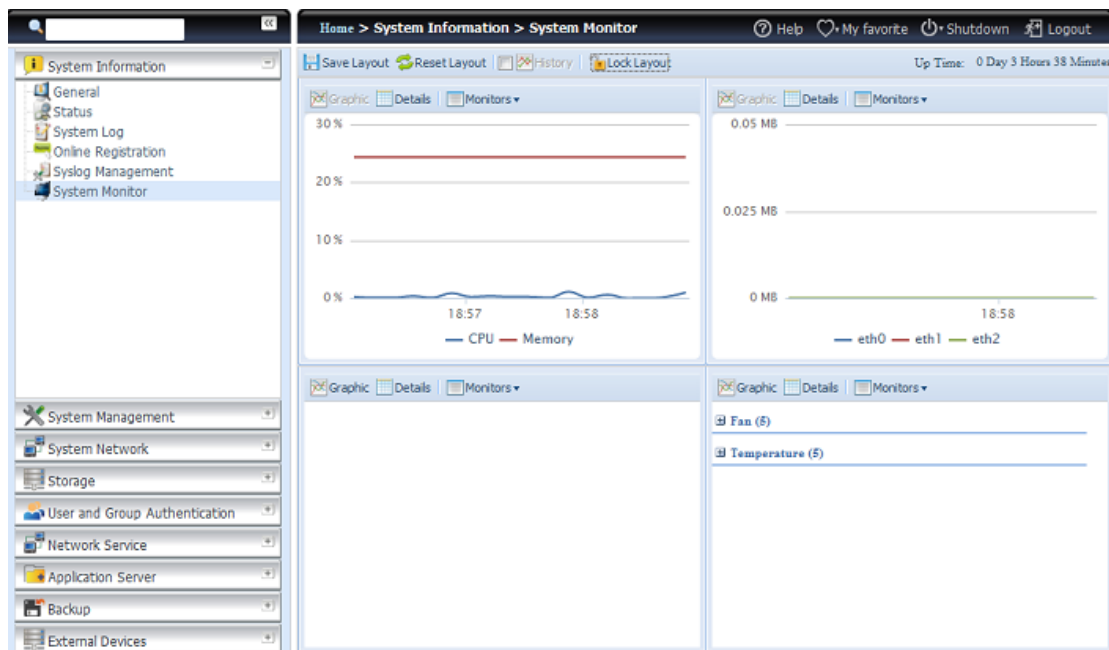

It is divided into 4 sections. Each section can be modified to monitor specific items by using the drop down list from the "Monitors" tab, simply click on the items you would like to monitor. From each section, you can also choose to display the information graphically by selecting "Graphic" or by plain text mode by selecting "Details".

NOTE

Only 2 sections can be set in graphic mode at the same time.

If graphic mode is chosen, 3 minutes of information is displayed on the x-axis. A resume of the information is displayed by dragging the mouse over the graphic at a specific time. See example below:

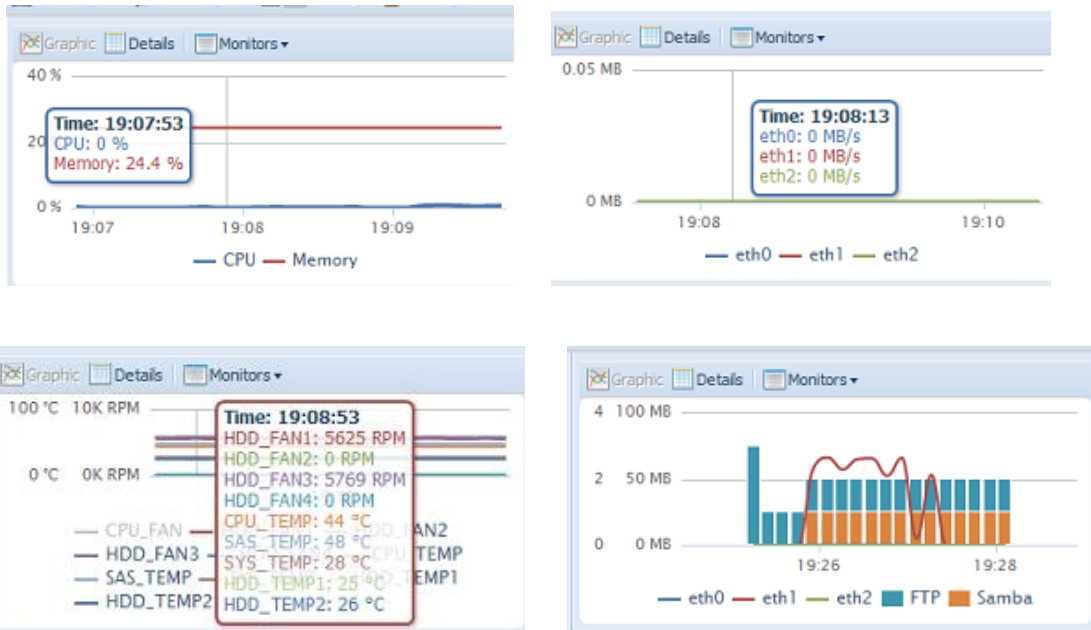

For the on-line users list, system monitor will display the on-line users and the share folder they have visited.

System Monitor		
CPU (1)		
Sys	0.75 %	
FTP (1)		
172.16.64.138	andy	_NAS_Picture_
Samba (1)		
172.16.64.138	root	test

System Monitor	
Item	Description
Save Layout	Saving selected monitoring items. Layout will remain the same for future visits.
Reset Layout	Set back to default monitoring settings and layout.
History	Click on this check box and system monitor will write the monitoring history to a designate path in the RAID volume.
Lock Layout	All of the monitoring items are fixed and cannot be changed. Click again to unlock it.

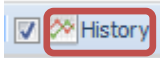
If the History has been enabled, click on  and system monitor will display the history with different period for selection.

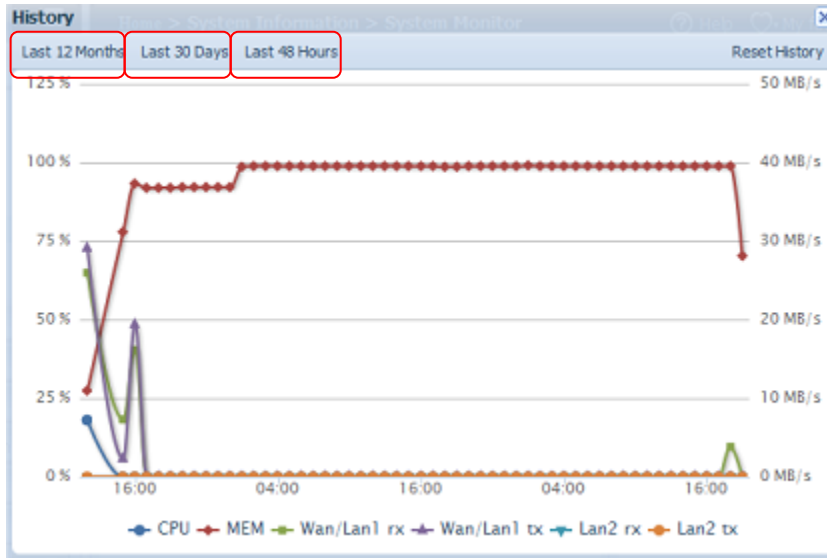

Hardware Information

From the **System Information** category, choose the **Hardware Information** item and the system will display the related HW details for the associated model. Below is an example of the information for a Thecus N4800Eco.

The screenshot shows the 'Hardware Information' page. The breadcrumb path is 'Home > System Information > Hardware Information'. The left sidebar lists 'System Information' with sub-items: General, Status, System Log, Syslog Management, System Monitor, Hardware Information (selected), and User Access Log. The main content area has tabs for 'General', 'Network Interface Card', 'Universal Serial Bus', and 'Disk Controller'. The 'General' tab is active, showing the following details:

CPU:	Intel CPU D2700 @ 2.13GHz
Memory:	2004 MB
DOM:	Single DOM
OLED:	Agent Revision:1600.2.0 Pic Revision:13

User Access Log

The screenshot shows the 'User Access Log Support' configuration page. The 'User Access Log' is set to 'Enable'. The 'Folder' is set to 'NAS_Public'. The 'Service' section has checkboxes for AFP, FTP, iSCSI, Samba/CIFS, and SSH, all of which are checked. An 'Apply' button is located below the service selection. A 'Description' section provides the following information:

- The access log will list selected services with associated items as shown below.
 AFP: Login, Logout
 FTP: Delete, Download, Folder Create, Login, Logout, Rename, Upload
 iSCSI: Login, Logout
 Samba: Delete, Folder Create, Folder Open, Read, Rename, Write
 SSH: Login, Logout
- To view the access log, please go to system log page then select desired services.
- The selected service will be restarted.

The **User Access Log Support** section allows administrators to select the desired protocols to record user activity for.

User Access Log	
Item	Description
User access log	Enable or disable the User Access Log service.
Folder	Select from the dropdown list where to store the user access log.
Service	Select from the check box which access details to record.
Apply	Click Apply to save changes.
Description	The user access list will record different activities depending on which protocol is selected. <ol style="list-style-type: none"> 1. AFP: User login and logout. 2. FTP: User file deletion, uploads/downloads, folder creation, object renaming, and login and logout. 3. iSCSI (if applicable): User login and logout. 4. Samba: User file deletion, folder creation, folder opening, and object reading, renaming, and writing. 5. SSH (if applicable): User login and logout.

After the **User Access Log Support** has been set up and the “Apply” button selected, all selected services will restart.

To view user access details related to the selected service(s), please go to **System Log** and choose a service from the “Display” dropdown list.

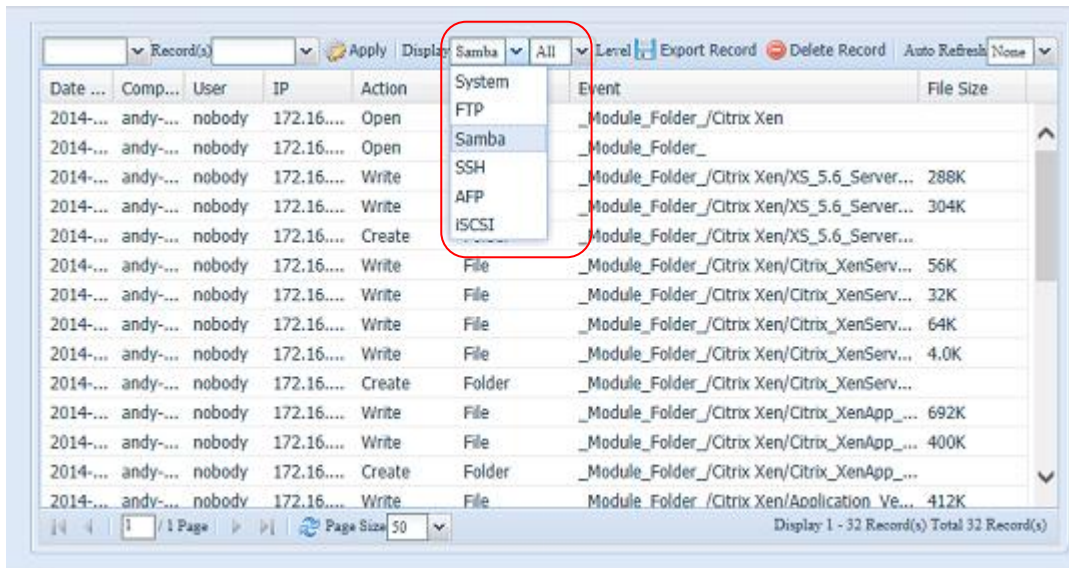

To export details from the User Access Log as a single file from target folder, administrators must first select the desired number of records from the dropdown list and also select the “Auto export” option. Please choose the number of logs export and click “Apply” to activate these settings.

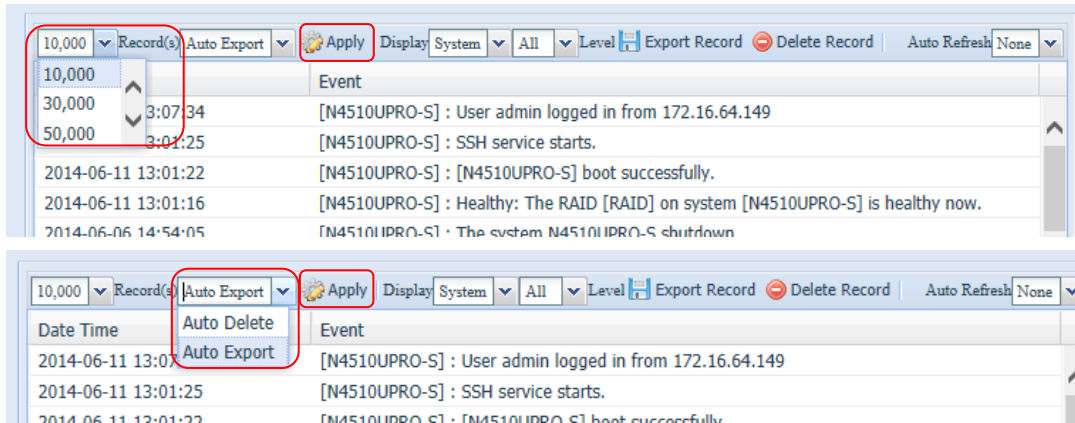

Once (for example) 10,000 records have been reached, the log file will appear in /NAS_public/access_log/

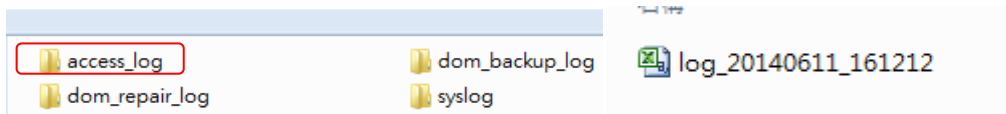

System Management

The **System Management** menu gives you a wealth of settings that you can use to configure your Thecus IP storage system administration and functions. You can set up system time, system notifications, and even upgrade firmware from this menu.

Date and Time: Setting system time

From the **System Management** menu, choose the **Date and Time** item and the **System Date and Time Settings** screen appears. Set the desired **Date**, **Time**, and **Time Zone**. You can also elect to synchronize the system time on Thecus IP storage with an **NTP (Network Time Protocol) Server**.

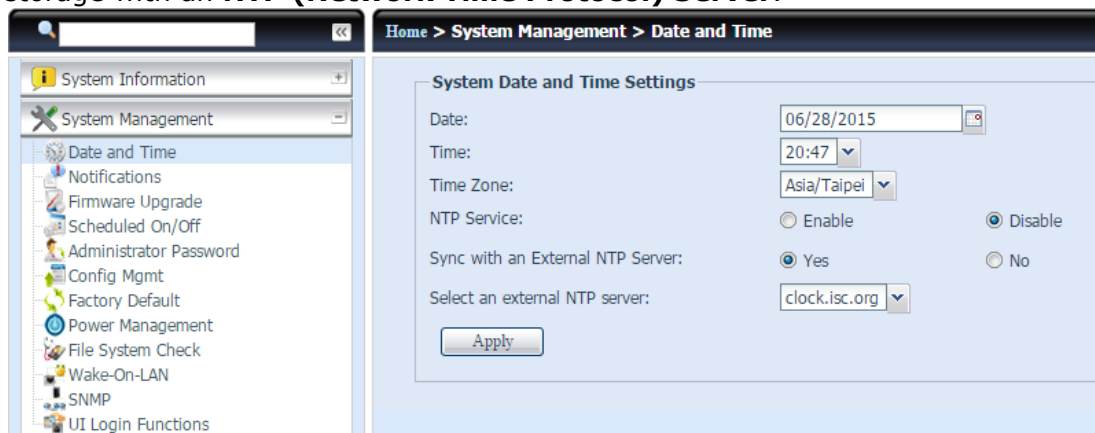

See the following table for a detailed description of each item:

Time	
Item	Description
Date	Sets the system date.
Time	Sets the system time.
Time Zone	Sets the system time zone.
NTP Service	Select Enable to synchronize with the NTP server. Select Disable to close the NTP server synchronization.
Sync with external NTP Server	Select YES to allow Thecus IP storage to synchronize with an NTP server of your choice.
Select an external NTP server	Choice an external NTP server.
Apply	Click Apply to save changes.

WARNING

If an NTP server is selected, please make sure your Thecus IP storage has been setup to access the NTP server.

Notification configuration

From the **System Management** menu, choose the **Notifications** item, and the **Notifications Configuration** screen appears. This screen lets you have Thecus IP storage notify you in case of any system malfunction. Press **Apply** to confirm all settings. See following table for a detailed description of each item.

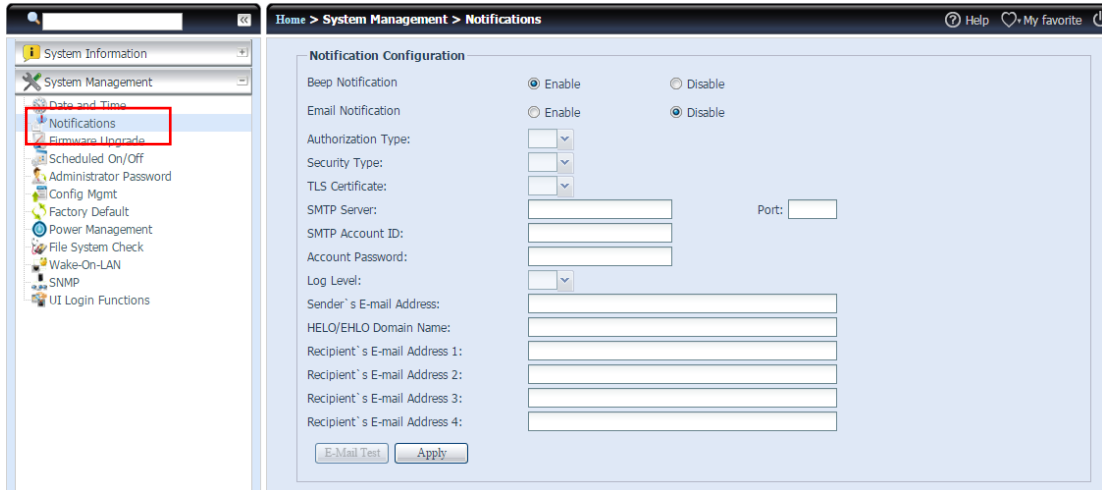

Notification Configuration	
Item	Description
Beep Notification	Enable or disable the system buzzer that beeps when a problem occurs.
Email Notification	Enable or disable email notifications of system problems.
Authentication Type	Select the SMTP Server account authentication type.
Security Type	Select Security Type: SSL or StartTLS
TLS Certificate	On/off TLS Certificate.
SMTP Server	Specifies the hostname/IP address of the SMTP server.
Port	Specifies the port to send outgoing notification emails.
SMTP Account ID	Set the SMTP Server Email account ID.
Account Password	Enter a new password.
Log Level	Select the log level to send the e-mail out.
Sender's E-mail Address	Set senders email address to send email notifications.
HELO/EHLO Domain Name	Enter the HELO/EHLO domain name.
Receiver's E-mail Address (1,2,3,4)	Add one or more recipient's email addresses to receive email notifications.

NOTE

Consult with your mail server administrator for email server information.

Firmware Upgrade

From the menu, choose the **Firmware Upgrade** item and the **Firmware Upgrade** screen appears.

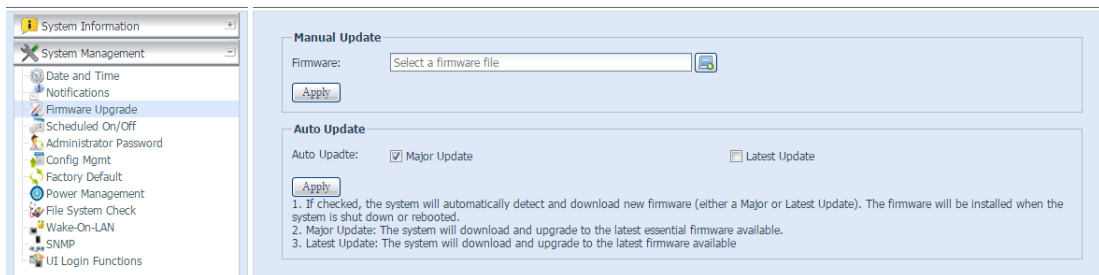

● Manual Update

Follow the steps below to upgrade your firmware manually:

1. Use the **Browse** button  to find the firmware file.
2. Press **Apply**.
3. The buzzer will beep and the Busy LED will blink until the upgrade is complete.

NOTE

- The buzzer only beeps if it is enabled in the System Notification menu.
- Check Thecus website for the latest firmware release and release notes.
- Downgrading firmware is not permitted.

WARNING

Do not turn off the system during the firmware upgrade process. This will lead to a catastrophic result that may render the system inoperable.

● Auto Update

If checked, the system will automatically detect and download new firmware (either a Major or Latest Update). The firmware will be installed when the system is shut down or rebooted.

Follow the steps below to upgrade your firmware automatically:

1. Check the **Major Update** or the **Latest Update**.
2. Press **Apply**.

Firmware Upgrade-Auto Update	
Item	Description
Major Update	The system will download and upgrade to the latest essential firmware available.
Latest Update	The system will download and upgrade to the latest firmware available

Schedule Power On/Off

Using the Thecus IP storage System Management, you can save energy and money by scheduling the Thecus IP storage to turn itself on and off during certain times of the day.

From the **System Management** menu, choose the **Schedule Power On/Off** item and the **Schedule Power On/Off** screen appears.

To designate a schedule for the Thecus IP storage to turn on and off, first enable the feature by checking the **Enable Schedule Power On/Off** checkbox.

Then, simply choose an on and off time for each day of the week.

Finally, click **Apply** to save your changes.

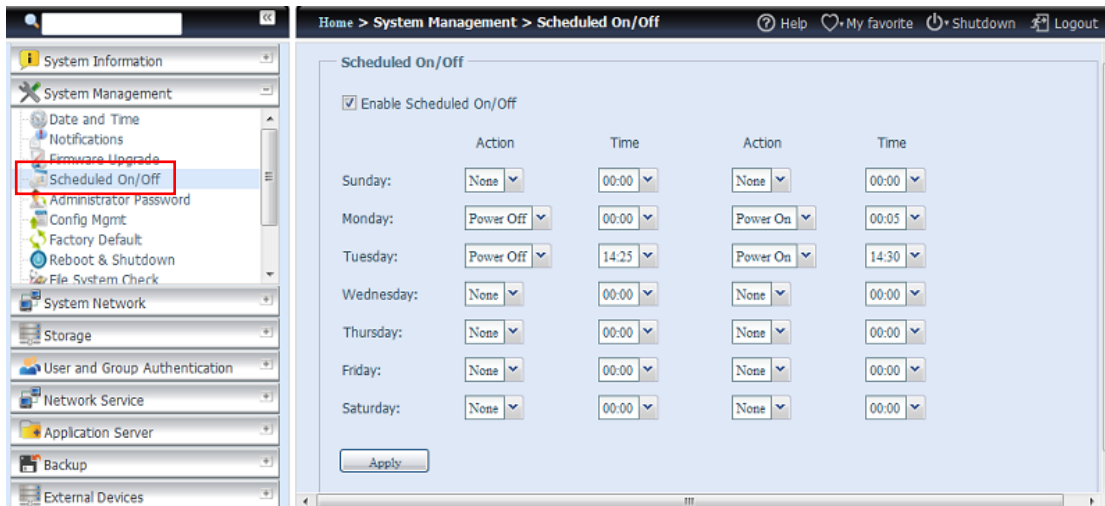

Example - Monday: On: 8:00; Off: 16:00

System will turn on at 8:00 AM on Monday, and off at 16:00 on Monday. System will turn on for the rest of the week.

If you choose an on time, but do not assign an off time, the system will turn on and remain on until a scheduled off time is reached, or if the unit is shutdown manually.

Example - Monday: On: 8:00

System will turn on at 8:00 AM on Monday, and will not shut down unless powered down manually.

You may also choose two on times or two off times on a particular day, and the system will act accordingly.

Example - Monday: Off: 8:00; Off: 16:00

System will turn off at 8:00 AM on Monday. System will turn off at 16:00 PM on Monday, if it was on. If the system was already off at 16:00 PM on Monday, system will stay off.

Administrator Password

From the menu, choose the **Administrator Password** item and the **Change Administrator Password** screen appears. Enter a new password in the **New Password** box and confirm your new password in the **Confirm Password** box. Press **Apply** to confirm password changes.

There is also a **password** to enter the **OLED** setting that you can setup here. Enter a new password in the **New Password** box and confirm your new password in the **Confirm Password** box. Press **Apply** to confirm password changes.

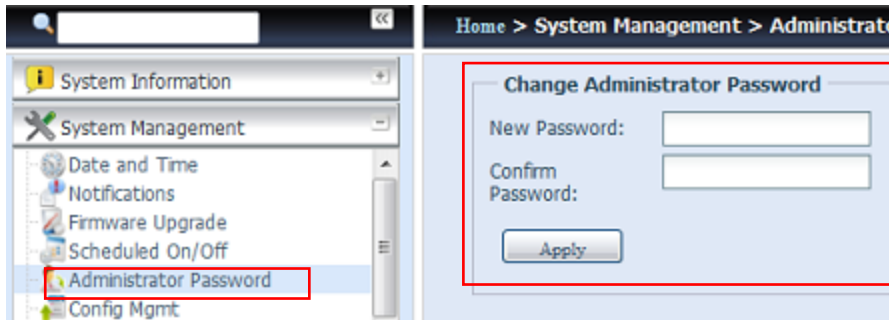

See the following table for a detailed description of each item.

Change Administrator and LCD Entry Password	
Item	Description
New Password	Type in a new administrator password.
Confirm Password	Type the new password again to confirm.
Apply	Press this to save your changes.

Config Mgmt

From the menu, choose the **Config Mgmt** item and the **System Configuration Download/Upload** screen appears. From here, you can download or upload stored system configurations.

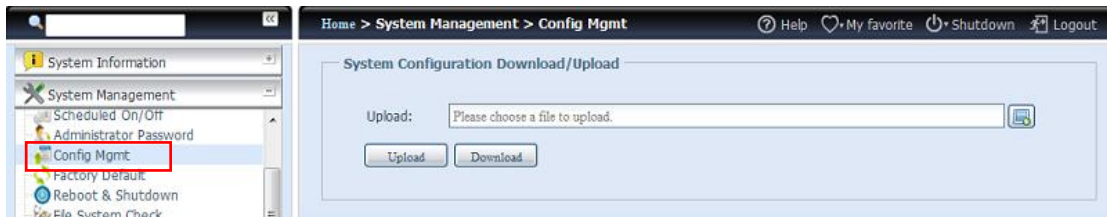

See the following table for a detailed description of each item.

System Configuration Download/Upload	
Item	Description
Download	Save and export the current system configuration.
Upload	Import a saved configuration file to overwrite the current system configuration.

NOTE

Backing up your system configuration is a great way to ensure that you can revert to a working configuration when you are experimenting with new system settings. The system configuration you have backed up can only be restored in the same firmware version. The backup details exclude user/group accounts.

Factory Default

From the menu, choose the **Factory Default** item and the **Reset to Factory Default** screen appears. Press **Apply** to reset Thecus IP storage to factory default settings.

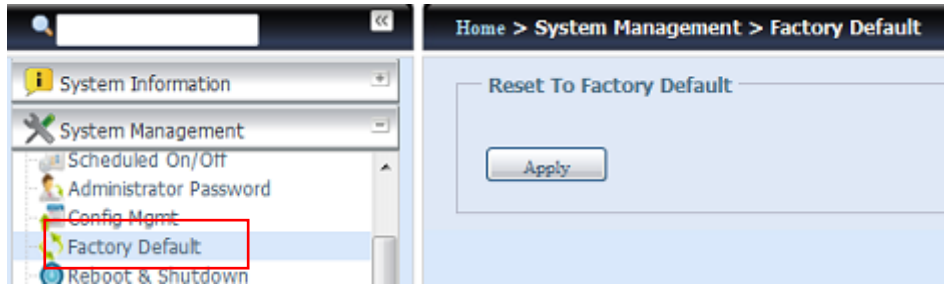

WARNING

Resetting to factory defaults will not erase the data stored in the hard disks, but WILL revert all the settings to the factory default values.

Power Management:

From the menu, choose **Power Management** item, and the **Shutdown/Reboot System** screen appears.

- **Shutdown/Reboot System**

Press **Reboot** to restart the system or **Shutdown** to turn the system off.

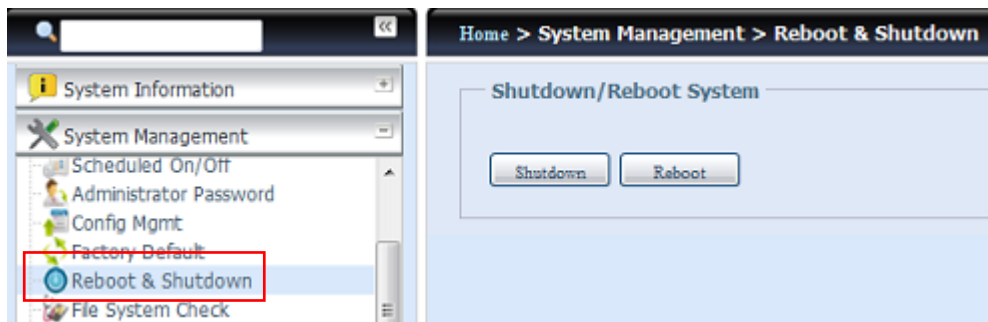

- **Automatic Resume**

The setting determines how the Thecus IP Storage behaves when the power is restored after an unexpected power loss.

Power Automatic Resume	
Item	Description
No	The Thecus IP Storage remains power off until power on manually.
Yes	The Thecus IP Storage power on automatically when the power restores..
Previous Status	If Thecus IP Storage was on , it will power on when the power restores. If Thecus IP Storage was off, it will remains power off when the power restores.
Apply	Press this to save your changes.

WARNING

The Automatic Resume feature will only be enabled when power is lost for at least 10 seconds.

File System Check

The File System Check allows you to perform a check on the integrity of your disks' file system. Under the menu, click **File system Check** and the **File System Check** prompt appears.



To perform a file system check, click **Apply**. Once clicked, the following prompt will appear:

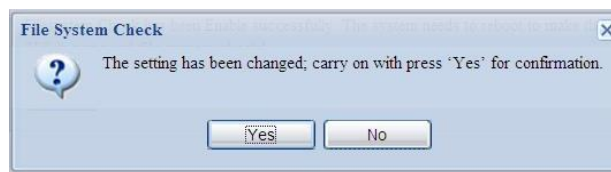

Click **Yes** to reboot the system.

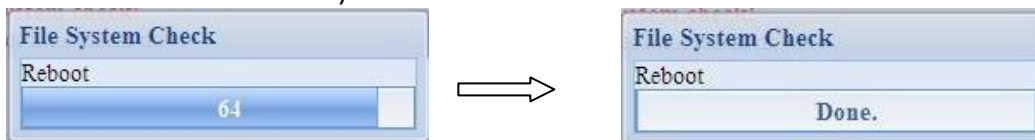

Once the system has rebooted, you will be returned to the **File System Check** prompt. There you will see the available RAID volumes to run the file system check. Check the desired RAID volumes and click **Next** to proceed with the file system check. Click **Reboot** to reboot without running the check.

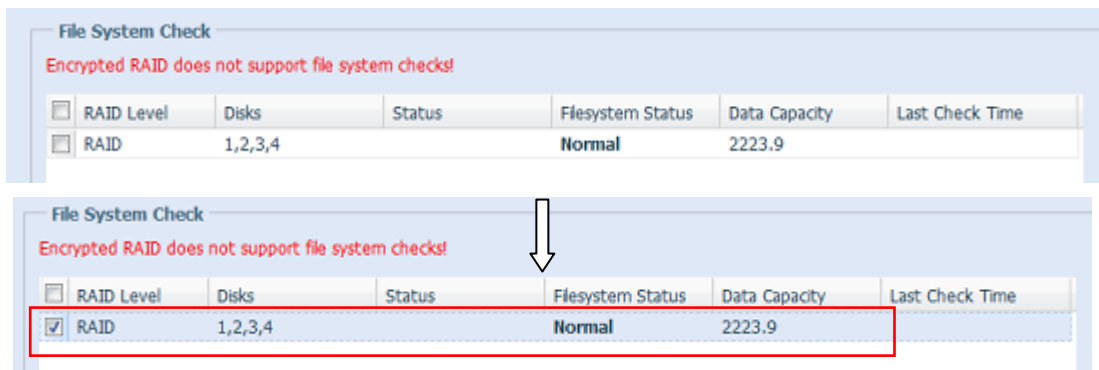

Once you click **Next**, you will see the following screen:



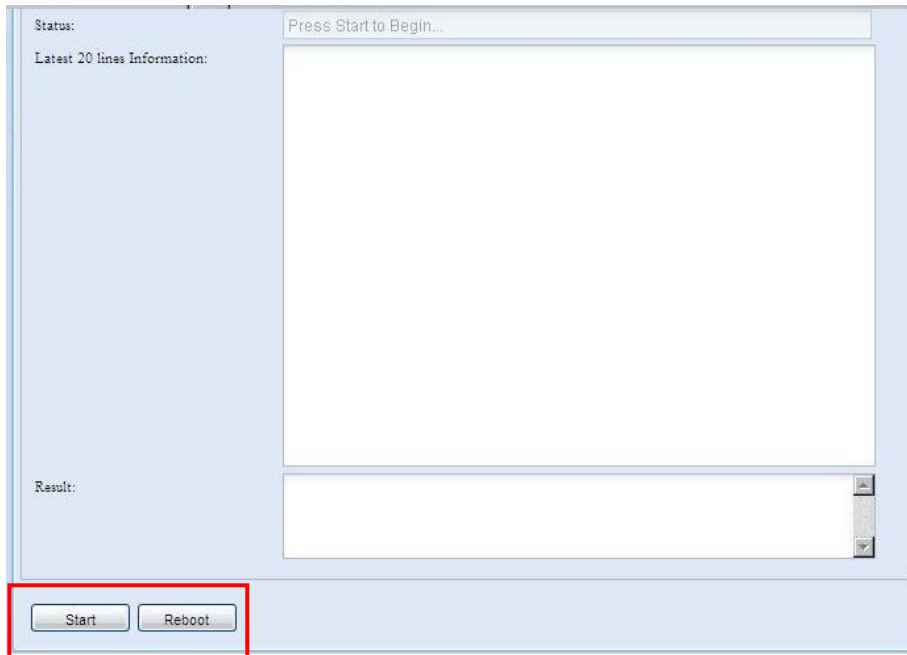

Click **Start** to begin the file system check. Click **Reboot** to reboot the system. When the file system check is running, the system will show 20 lines of information until it is complete. Once complete, the results will be shown at the bottom.

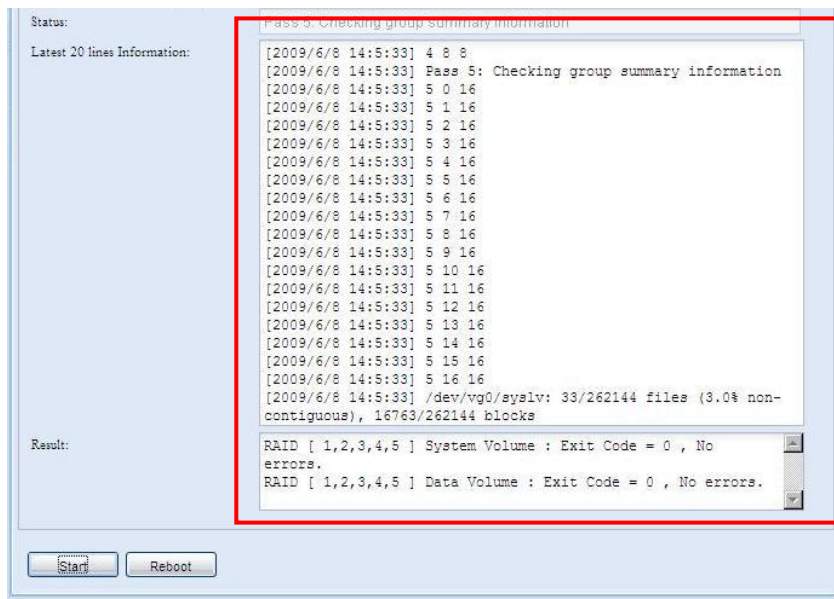

NOTE

The system must be rebooted before Thecus IP storage can function normally after file system check completes.

Wake-Up On LAN (WOL)

The Thecus IP storage has the ability to be awoken from sleep mode via WAN/LAN1 or LAN2 port.

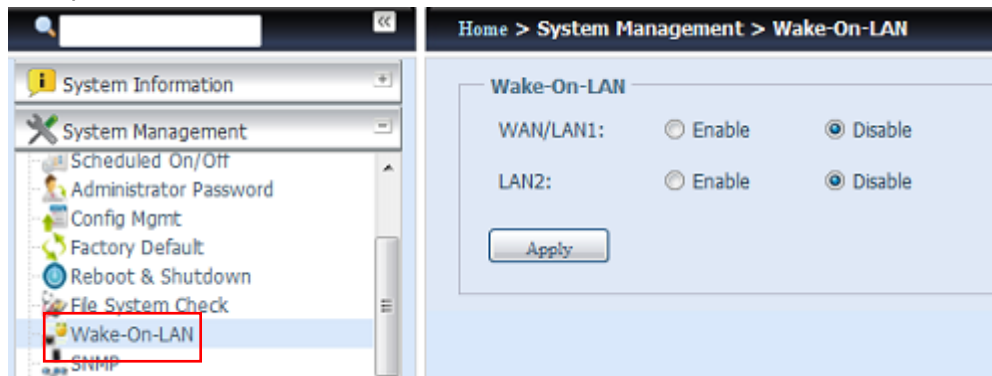

From the menu, choose the **WOL** item, and the **Wake-up On LAN** screen appears. From here, you can **Enable** or **Disable**.

Wake-up On LAN Configuration	
Item	Description
WAN/LAN1	Enable or Disable WOL service from WAN/LAN1
LAN2	Enable or Disable WOL service from LAN2
Apply	Click Apply to save changes.

SNMP Support

From the menu, choose the **SNMP** item and the **SNMP Support** screen appears. You could enable the SNMP function and filled in the related information in each fields. With the SNMP management software, you can get other system's basic information.

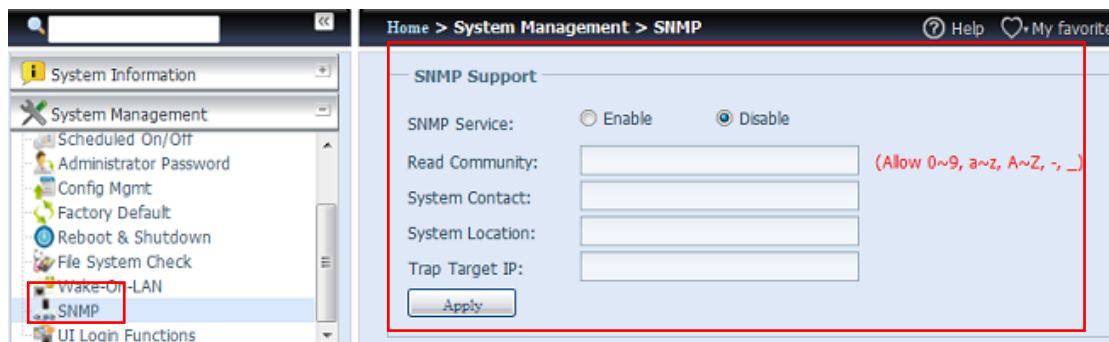

From the menu, choose the **SNMP** item, and the **SNMP Support** screen appears. From here, you can **Enable** or **Disable**.

UI Login Function

Adjusts UI Login Configuration settings, you can enable/disable the Web Disk, Photo Server and modules functions, according to your needs.

UI Login Functions

Web Disk: Enable Disable

Photo Server: Enable Disable

Module: Enable Disable

System Network

Use the **System Network** menu to make network configuration settings to an on board network port or additional NIC as well as DHCP and link aggregation.

Networking

From the **System Network** menu, choose **Networking**, and the **Networking Configuration** screen appears. This screen displays the network parameters of the global setting and available network connection. You may change any of these items and press **Apply** to confirm your settings. See a description of each item in the following table:

Home > System Network > Networking ? Help My favorite

Host Settings

Host Name: Domain Name:

WINS Server 1: WINS Server 2:

DNS Settings

Mode: Manual DHCP (Get From WAN/LAN1)

DNS 1:

DNS 2:

DNS 3:

WAN/LAN1 LAN2 LAN3 Additional LAN4 Additional LAN5 Additional LAN6 Additional LAN7

Status: Disabled Enabled Speed: 1000Mb/s

MAC Address: 00:14:FD:15:59:84 Link Status: Connected

Jumbo Frame:

IPv4

Enable:

Mode: Manual DHCP

IP:

Netmask:

Gateway:

IPv6

Enable:

Mode: Manual DHCP

IP:

Prefix Length:

Gateway:

Note:

Default Gateway:

The available system network ports are coming from embedded system ports and additional system ports added through the reserved PCI-e slot with associated

compatible list. Therefore, the screen shown above is an example of a Thcus N16000 with 3 on board GbE NIC and an additionally Intel PRO/1000 PT quad port NIC, for a total of 7 NIC ports.

Network Configuration (Global parameter)	
Item	Description
Host name	Host name that identifies the Thcus IP storage on the network.
Domain name	Specifies the domain name of Thcus IP storage.
WINS Server	To set a server name for NetBIOS computer.
DNS Mode	Select the DNS server is coming from DHCP server or manual input. A total of 3 DNS servers can be input. If the DNS setting is chosen from DHCP server, then it will refer to WAN/LAN1 port.
DNS Server 1,2,3	Domain Name Service (DNS) server IP address.
Network Configuration (NIC port)	
Link speed	Display associated NIC port link speed.
Link status	Display associated NIC port link status.
MAC address	MAC address of the network interface.
Jumbo Frame Support	Enable or disable Jumbo Frame Support of associate interface on your Thcus IP storage.
IPv4/IPv6	Click to enable IPv4/IPv6 for TCP/IP. The default is IPv4 enabled.
Mode	It can choose a static IP or Dynamic IP.
IP	IP address of associate NIC interface.
Netmask/Prefix Length	Input netmask for IPv4 and Prefix length for IPv6.
Gateway	Gateway for associate NIC.
Default gateway	It can be chosen from a drop down list of default gateway that's been used for the Thcus IP storage.

NOTE

- Only use Jumbo Frame settings when operating in a Gigabit environment where all other clients have Jumbo Frame Setting enabled.
- Proper DNS setting is vital to networks services, such as SMTP and NTP.

WARNING

Most faster Ethernet (10/100) Switches/Routers do not support Jumbo Frame and will not be able to connect to your Thcus NAS after Jumbo Frame is turned on.

VLAN

Each NIC is capable of VLAN support. To enable VLAN, simply click the check box and input the VLAN ID (VLAN ID can be any digital number). The system with the same VLAN ID will become a Virtual LAN group to allow more specific communication among members.

The screenshot shows the network configuration for WAN/LAN1. The interface includes the following fields and values:

- Status: Normal
- Speed: 1000Mb/s
- MAC Address: 00:14:FD:17:99:76
- Link Status: Connected
- Jumbo Frame: 1500 bytes
- Enable VLAN:
- VLAN ID:

DHCP/RADVD

From the **System Network** menu, choose **DHCP/RADVD**, and the **DHCP/RADVD Configuration** screen appears. This screen displays available NIC status. If each NIC has been set-up to a static IP, then each NIC can be configured to act as DHCP/RADVD server.



DHCP/RADVD Server Configuration

A DHCP/RADVD server can be configured to assign IP addresses (IPv4) or Prefix (IPv6) to devices connected to the associated NIC port.

DHCP Configuration	
Item	Description
DHCP/RADVD Service	Enable or disable the DHCP/RADVD service to automatically assign IP address to PCs connected to associate NIC interface.
Start IP (IPv4)	Specifies the lower IP address of the DHCP range.
End IP in (IPv4)	Specifies the highest IP address of the DHCP range.
Default Gateway (IPv4)	Specifies gateway for the DHCP server service.
DNS Server 1,2,3 (IPv4)	Displayed the DNS server IP address.
Prefix (IPv6)	Specifies prefix
Prefix Length (IPv6)	Specifies prefix length

WARNING

The IP address of associated NIC should not be in the range of the Start IP address and End IP address (IPv4).

Linking Aggregation

The Thecus IP storage supports link aggregation from either on board network port or additional NIC. Simply click on "+" as shown in the screen shot below.

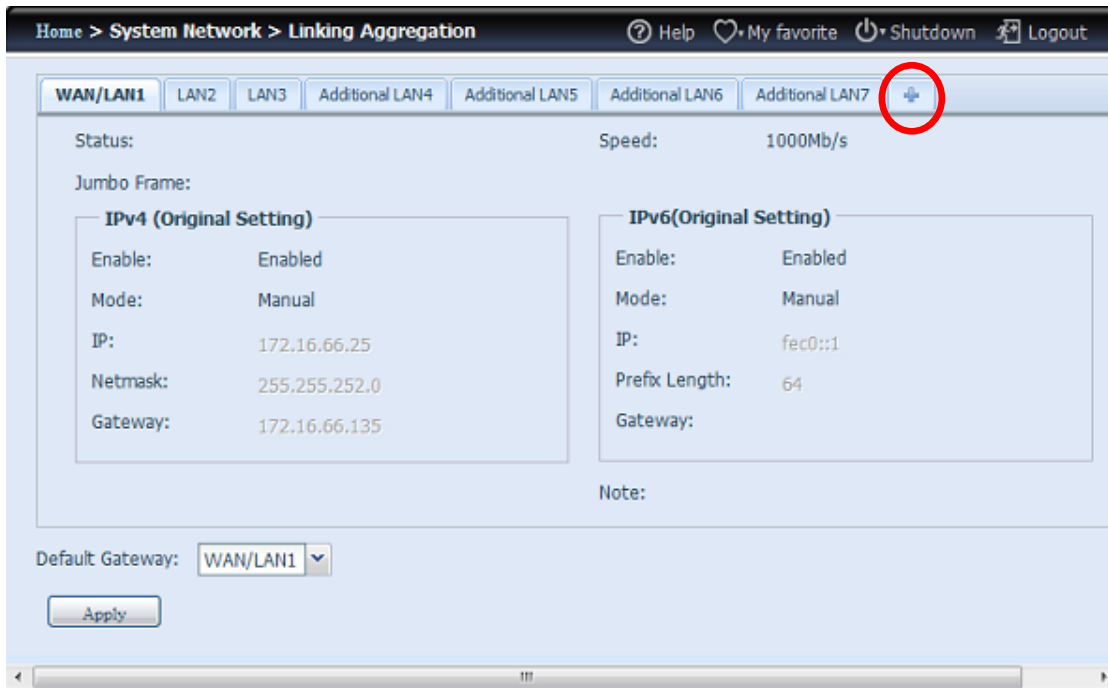

The associated screen shot will appear after the "+" is clicked.

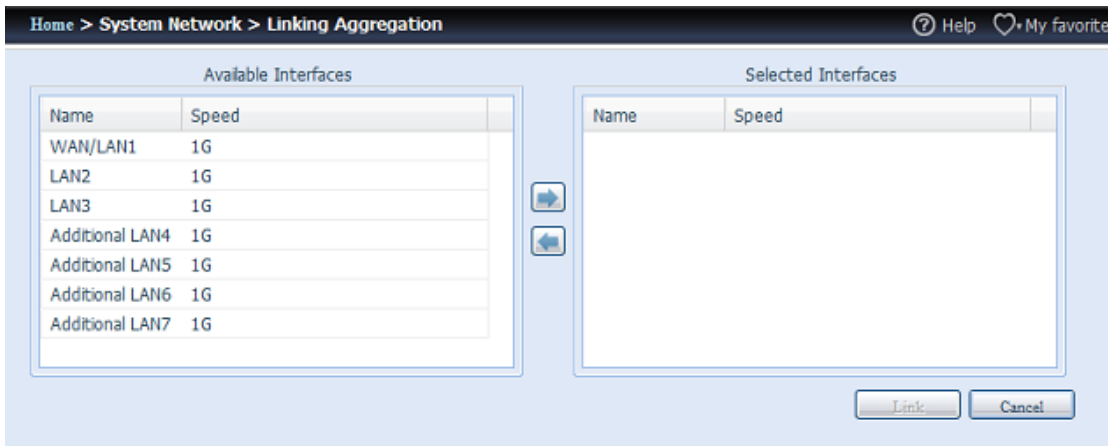

Select from available network port then move over to selected box.

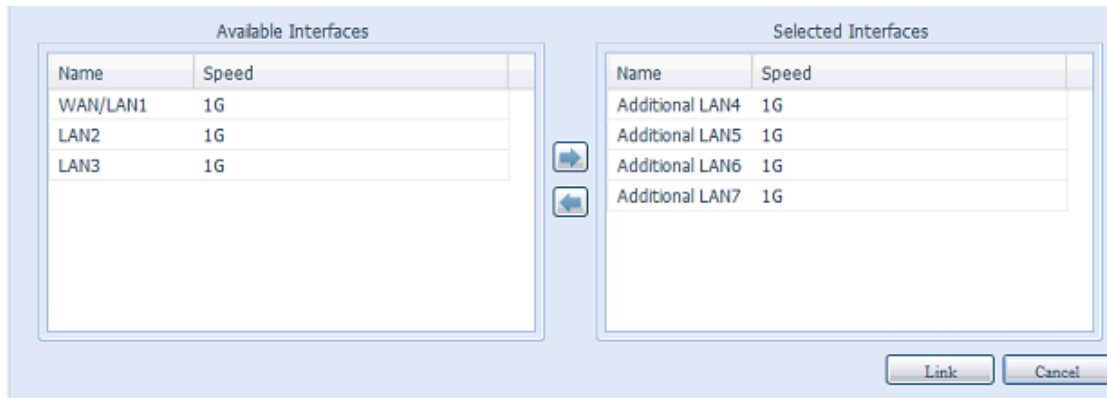

Click "Link" to confirm the selection. The newly created tab will appear for more settings required to complete the link aggregation configuration.

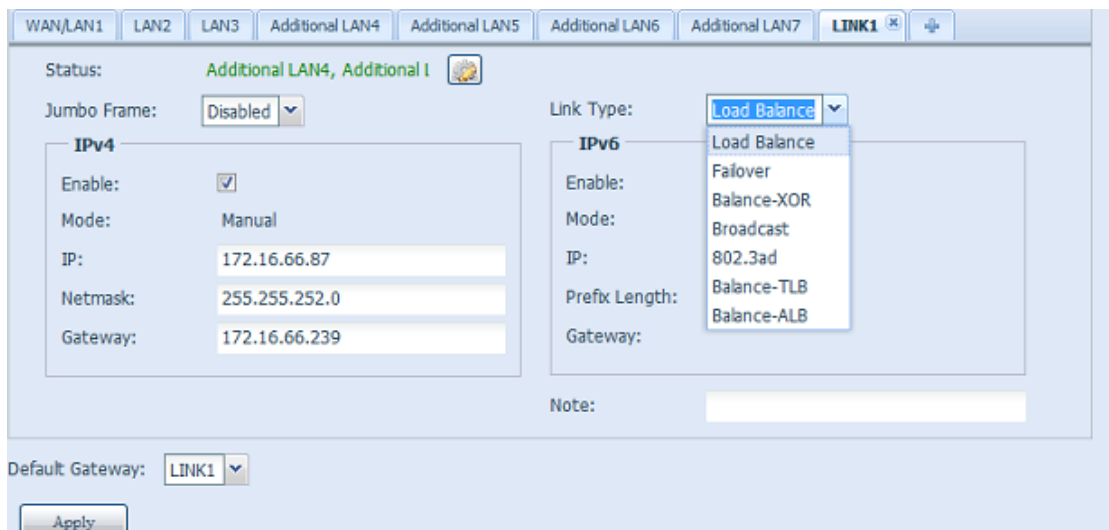

Link1 Configuration	
Status	Specifies the network ports being used with the associated link aggregation. Click on  to modify the selected network ports.
Jumbo Frame Support	Enable or disable Jumbo Frame Support of the associated interface on your Thecus IP storage.
Link Type	Select from drop down list for desired mode.
IPv4/IPv6	Click to enable IPv4/IPv6 for TCP/IP. The default is IPv4 enabled.
Mode	It has to be a static IP with the link aggregation being used.
IP	IP address of link aggregation.
Netmask/Prefix Length	Input netmask for IPv4 and Prefix length for IPv6.
Gateway	Gateway for associated link aggregation
Default gateway	It can be chosen from the drop down list of default gateway being used for the Thecus IP storage.

Now under the networking, a "Link1" tab will appear from the network title bar.

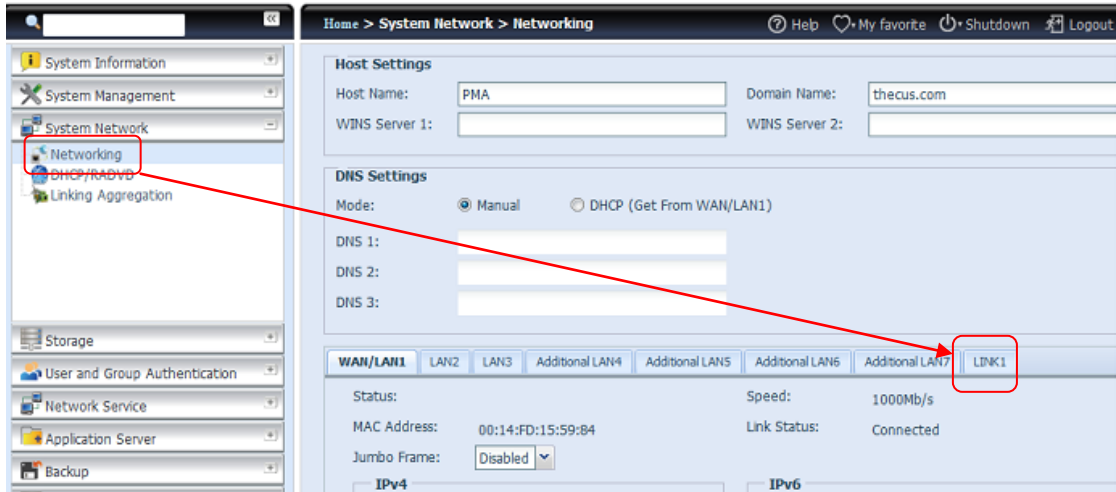

To modify or delete LINK1, go to Link Aggregation setting page. Click on

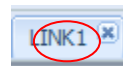

to modify the settings or click on

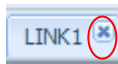

Additional LAN

Other than on-board LAN port, Thecus IP storage supports additional NIC to be added in its available PCI-e slot. For the details of additional NIC support list please visit Thecus website.

http://www.thecus.com/sp_comlist.php

Once the additional NIC is installed into Thecus IP storage, the "Additional LANx" will appear under the "Networking" category. Click the associated NIC to setup the details. The screen shot below shows an example of an Intel PRO/1000 PT Quad port installed thru a PCI-e slot in the Thecus IP storage.

Home > System Network > Linking Aggregation

Help My favorite Shutdown Logout

WAN/LAN1 LAN2 LAN3 Additional LAN4 Additional LAN5 Additional LAN6 Additional LAN7

Status: Speed: 1000Mb/s

Jumbo Frame:

IPv4 (Original Setting)		IPv6 (Original Setting)	
Enable:	Enabled	Enable:	Enabled
Mode:	Manual	Mode:	Manual
IP:	172.16.66.25	IP:	fec0::1
Netmask:	255.255.252.0	Prefix Length:	64
Gateway:	172.16.66.135	Gateway:	

Note:

Default Gateway: WAN/LAN1

Apply

Storage Management

The **Storage** menu displays the status of storage devices installed in the Thecus IP storage. It includes storage configuration options such as RAID and disk settings, folder configuration, iSCSI and ISO Mount.

Disk Information

From the **Storage** menu, choose the **Disk Information** item and the **Disk Information** screen appears. From here, you can see various installed hard disks. The disk slot position will appear if the mouse is moved over the installed disk.

NOTE

- The screen shot below is just an example from a Thecus IP Storage. The disk slots number can range from 8, 12 to 16 slots depending on the model of Thecus IP storage. Also it will list the disk info of JBOD devices if applicable

The screenshot shows the 'Disk Information' page in a web browser. The main table lists disks with columns for Disk No., Model, Capacity, Firmware, and Bad Block. There are two groups of disks: 'N8900 (7Disks)' and 'D16000 - 4 (6Disks)'. A detailed view of disk 7 is shown on the right, including a 'Position' grid.

Disk No.	Model	Capacity	Firmware	Bad Block
N8900 (7Disks)				
2	ST31000524NS	932 GB	SN11	
3	WD6000BKHG-02A29	559 GB	VG03	
4	WD6000BKHG-02A29	559 GB	VG03	
5	Hitachi HDS72101	932 GB	A3MA	
6	Hitachi HDS72101	932 GB	A3MA	
7	Hitachi HDS72101	932 GB	A25C	
8	Hitachi HDS72101	932 GB	A25C	
D16000 - 4 (6Disks)				
J4-6	WD6000BKHG-02A29	559 GB	VG03	
J4-7	WD6000BKHG-02A29	559 GB	VG03	

Total Capacity: 9132 (GB)

Disk Power Management: 30 Minute Apply

Position	1	2	3	4
9				
8				

Disks Information	
Item	Description
Disk No.	Indicates disk location.
Capacity	Shows the SATA hard disk capacity.
Model	Displays the SATA hard disk model name.
Firmware	Shows the SATA hard disk firmware version.
Bad Block scan	Yes to start scan Bad Block.

S.M.A.R.T. Information

On the **Disk Information** screen, select a disk then click on "Smart" to list the **S.M.A.R.T.** info of the associated disk.

The screenshot shows the 'Disk Information' page with the 'Smart' button highlighted by a red box. The table below shows the same disk information as the previous screenshot, but with a 'Position' grid visible for disk 7.

Disk No.	Model	Capacity	Firmware	Bad Block
N8900 (7Disks)				
2	ST31000524NS	932 GB	SN11	
3	WD6000BKHG-02A29	559 GB	VG03	
4	WD6000BKHG-02A29	559 GB	VG03	
5	Hitachi HDS72101	932 GB	A3MA	
6	Hitachi HDS72101	932 GB	A3MA	

Position	1	2	3	4
9				
8				

You may also perform a disk SMART test (doesn't apply to SAS HDD); simply click "Test" to start the SMART test. The result is only for reference and the system will not take any action from its results.

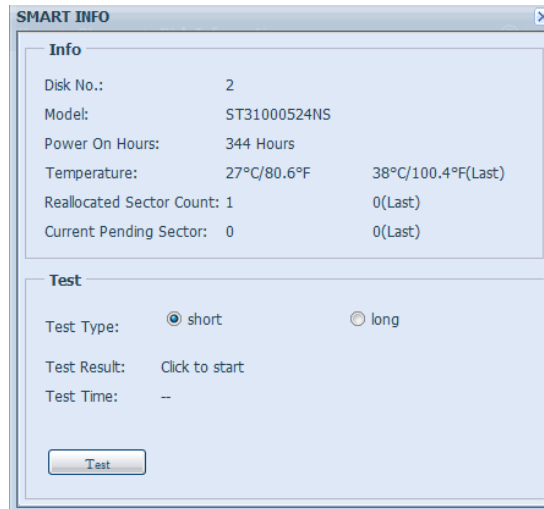

S.M.A.R.T. Information	
Item	Description
Tray Number	Tray the hard disk is installed in.
Model	Model name of the installed hard disk.
Power ON Hours	Count of hours in power-on state. The raw value of this attribute shows total count of hours (or minutes, or seconds, depending on manufacturer) in power-on state.
Temperature Celsius	The current temperature of the hard disk in degrees Celsius.
Reallocated Sector Count	Count of reallocated sectors. When the hard drive finds a read/write/verification error, it marks this sector as "reallocated" and transfers data to a special reserved area (spare area). This process is also known as remapping and "reallocated" sectors are called remaps. This is why, on a modern hard disks, you cannot see "bad blocks" while testing the surface - all bad blocks are hidden in reallocated sectors. However, the more sectors that are reallocated, the more a decrease (up to 10% or more) can be noticed in disk read/write speeds.
Current Pending Sector	Current count of unstable sectors (waiting for remapping). The raw value of this attribute indicates the total number of sectors waiting for remapping. Later, when some of these sectors are read successfully, the value is decreased. If errors still occur when reading sectors, the hard drive will try to restore the data, transfer it to the reserved disk area (spare area), and mark this sector as remapped. If this attribute value remains at zero, it indicates that the quality of the corresponding surface area is low.
Test Type	Set short or long time to test.
Test Result	Result of the test.
Test Time	Total time of the test.

NOTE

If the Reallocated Sector Count > 32 or the Current Pending Sector of a hard disk drive > 0 , the status of the disk will show "Warning". This warning is only used to alert the system administrator that there are bad sectors on the disk, and they should replace those disks as soon as possible.

Bad Block Scan

On the **Disk Information** screen, select a disk then click on "Detect Bad Block" to perform bad block scan of the associated disk. The result is only for reference and the system will not take any action from its results.

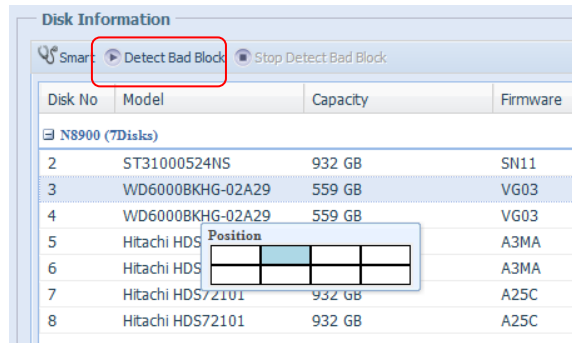

The bad block scan can be terminated by clicking on "Stop Detect Bad Block".

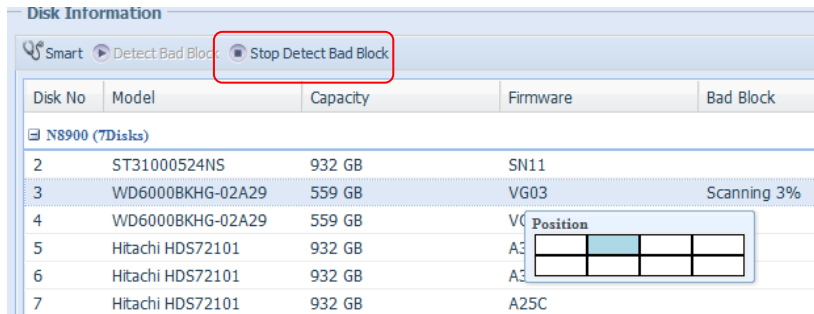

For Thecus product (N8900/N12000/N16000/N12850/N16850 series) which support JBOD device, the attached JBOD device and his associated disks will also list under the **Disk Information** page. Please see below for a screen shot of a N8900 with a Thecus D16000 attached and installed disks list on.

The JBOD device will have a unique ID that ranges from 1 to 10. The disk no. lead ID will indicate the different JBOD devices. The screen shot below show a JBOD device with ID 4, so J4-6 is indicated under the JBOD device disk list with 6 slots.

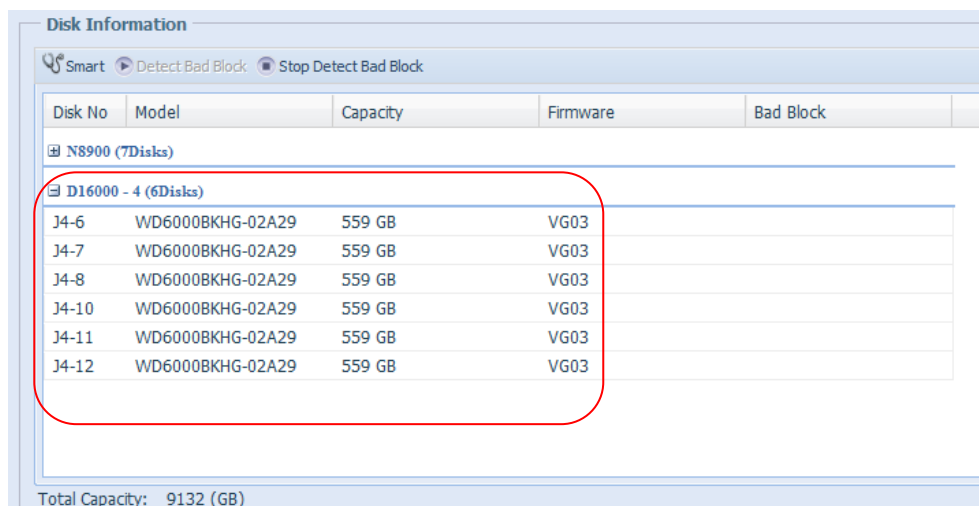

RAID Information

From the **Storage** menu, choose the **RAID Management** item and the **RAID Management** screen appears.

This screen lists the RAID volumes currently residing in the Thecus IP storage. From this screen, you can get information about the status of your RAID volumes, as well as the capacities allocated for data.

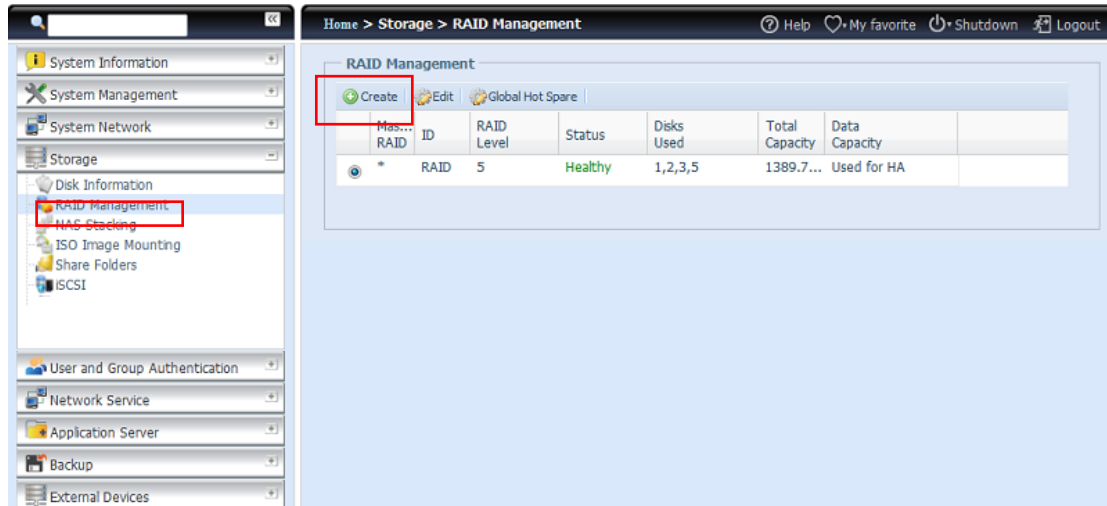

RAID Information	
Item	Description
Master RAID	The RAID volume currently designated as the Master RAID volume.
ID	ID of the current RAID volume. NOTE: All RAID IDs must be unique.
RAID Level	Shows the current RAID configuration.
Status	Indicates status of the RAID. Can read either Healthy , Degraded , or Damaged .
Disks Used	Hard disks used to form the current RAID volume.
Total Capacity	Total capacity of the current RAID.
Data Capacity	Indicates the used capacity and total capacity used by user data.

Create a RAID

On the **RAID Information** screen, press the **Create** button to go to the **RAID Volume Creation** screen. In addition to RAID disk information and status, this screen lets you make RAID configuration settings.

Using **Create RAID**, you can select stripe size, choose which disks are RAID disks or the Spare Disk. .

RAID Configurations	
Item	Description
Disk No.	Number assigned to the installed hard disks.
Capacity (MB)	Capacity of the installed hard disks.
Model	Model number of the installed hard disks.
Status	Status of the installed hard disks.
Used	If this is checked, current hard disk is already part of a RAID volume.
Spare	If this is checked, current hard disk is designated as a spare for a RAID volume.
Master RAID	Check a box to designate this as the Master RAID volume. See the NOTE below for more information.

Stripe Size	This sets the stripe size to maximize performance of sequential files in a storage volume. Keep the 64K setting unless you require a special file storage layout in the storage volume. A larger stripe size is better for large files.
Data Percentage	The percentage of the RAID volume that will be used to store data.
Create	Press this button to configure a file system and create the RAID storage volume.

To create a RAID volume, follow the steps below:

1. On the **RAID Information** screen, clicks create.

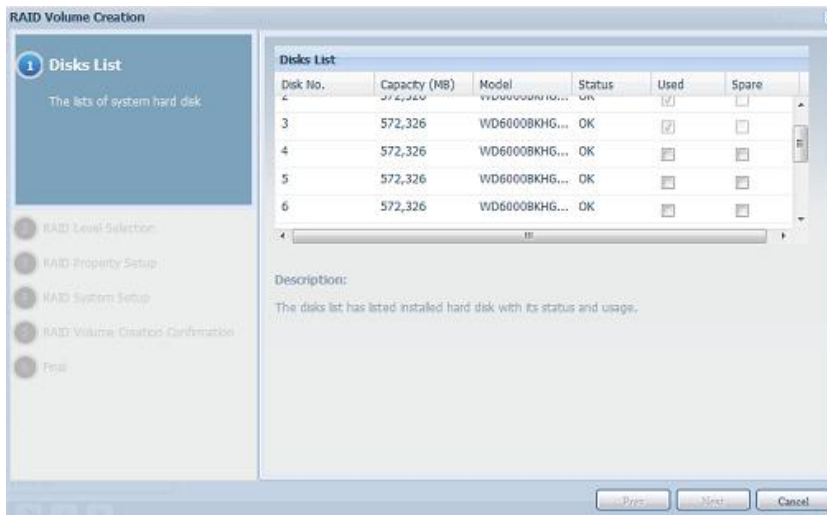

2. On the **RAID Configuration** screen, set the RAID storage space as **JBOD, RAID 0, RAID 1, RAID 5, RAID 6, RAID 10, RAID 50** or **RAID 60** (depends on model)— see [Appendix B: RAID Basics](#) for a detailed description of each.



NOTE

N8900/N12000/N16000 Series supports multiple RAID modes and are capable of creating up to five RAID volumes within a single NAS system.

3. Specify a RAID ID.

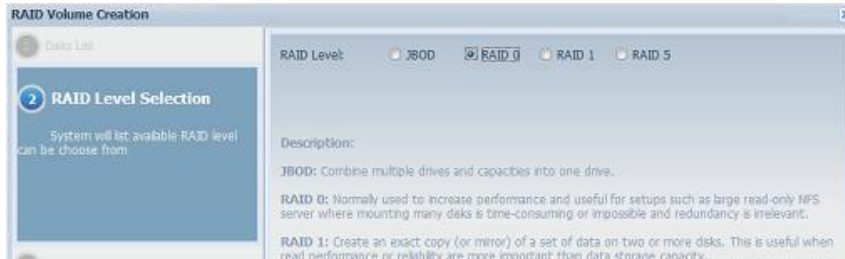

- If this RAID volume is meant to be the Master RAID volume, tick the **Master RAID** checkbox.

NOTE

In a multiple RAID configuration, one RAID volume must be designated as the Master RAID volume. The Master RAID volume will store all installed modules. If the Master RAID is changed to another location (i.e. assigning volume 2 to be the Master RAID volume after volume 1 had been previously assigned), then all modules must be reinstalled. In addition, all system folders that were contained on the Master RAID volume will be invisible. Reassigning this volume to be the Master RAID will make these folders visible again.

- Selected whether the RAID volume will be encrypted or not. The RAID volume can protect data by using RAID Volume Encryption function to prevent the risk of data exposure. To activate this function, the **Encryption** option needs to be enabled while the RAID is created and followed by a password input for identification. Also, an external writable USB disk plugged into any USB port on the system is required to save the password you have entered while the RAID volume is being created. See the screenshot below for details.

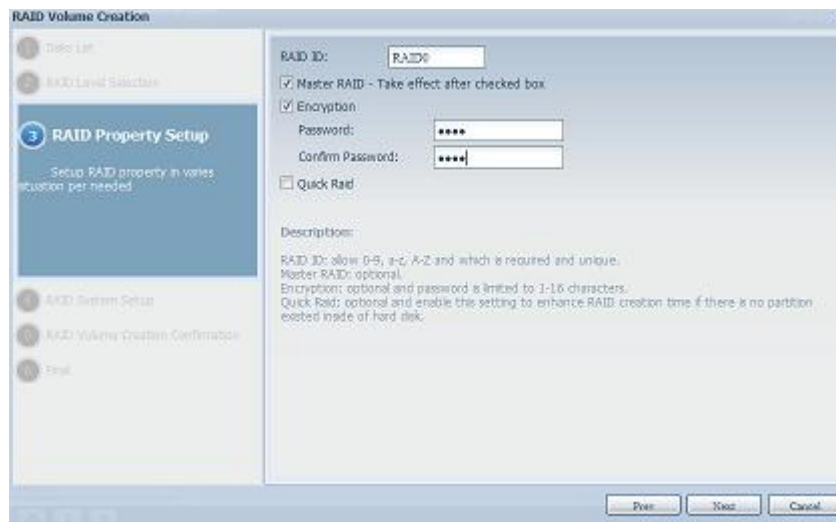

Once the **Create** button has been pressed with the **Encryption** checkbox enabled, the following message pop-up will appear for confirmation.

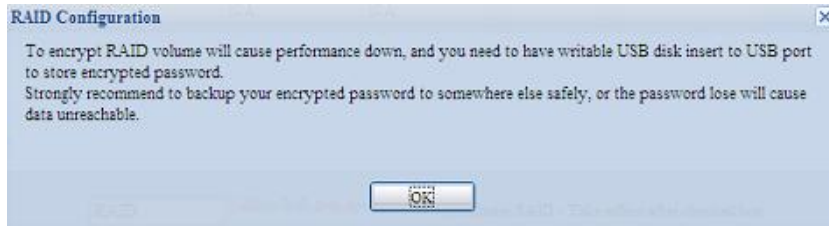

After the RAID volume has been created, you may remove the USB disk until the next time the system boots. The RAID volume cannot be mounted if the USB disk with the encryption key isn't found in any system USB port when the volume is accessed. To activate the encrypted volume, plug the USB disk containing the encryption key and into any system USB port.

We strongly recommended copying the RAID volume encryption key to a safe place. You can find the encryption key file from the USB disk in the following format:

`(RAID volume created date)_xxxxxx.key`

WARNING

Please keep your USB disk in a safe place and also backup the encrypted key.

There is no way to rescue data back if the key is lost.

NOTE

With RAID volume encryption enabled, the system performance will go down.

RAID volumes with encryption enabled will be displayed with a key lock symbol next to volume ID name.

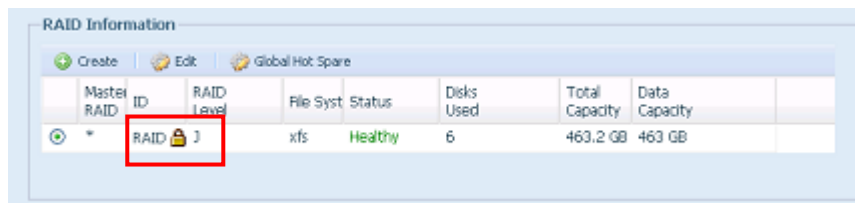

6. Quick RAID — Enabled the quick RAID setting is going to enhance RAID creation time.

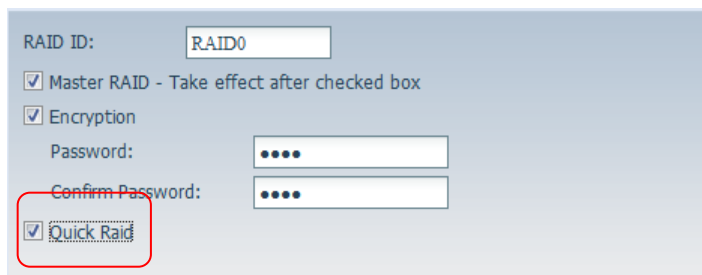

NOTE

We recommend using the "Quick RAID" setting only if the hard disks are brand new or if no existing partitions are contained.

7. Specify a stripe size — 64K is the default setting.

- Selected the file system you would like to have for this RAID volume. The selection is available from ext3, XFS and ext4.

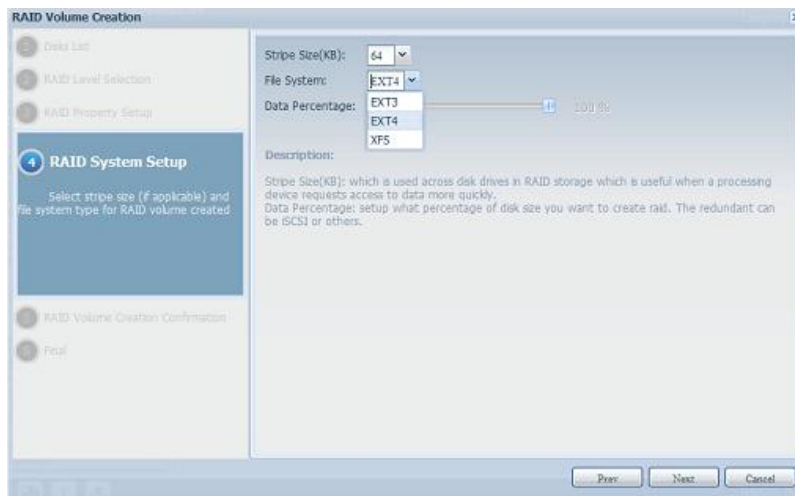

NOTE

Single volume size supported:
 ext3 → 8TB
 XFS → 48TB
 ext4 → 36TB

- Press **Submit** to build the RAID storage volume.

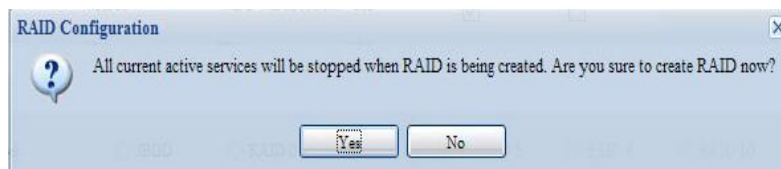
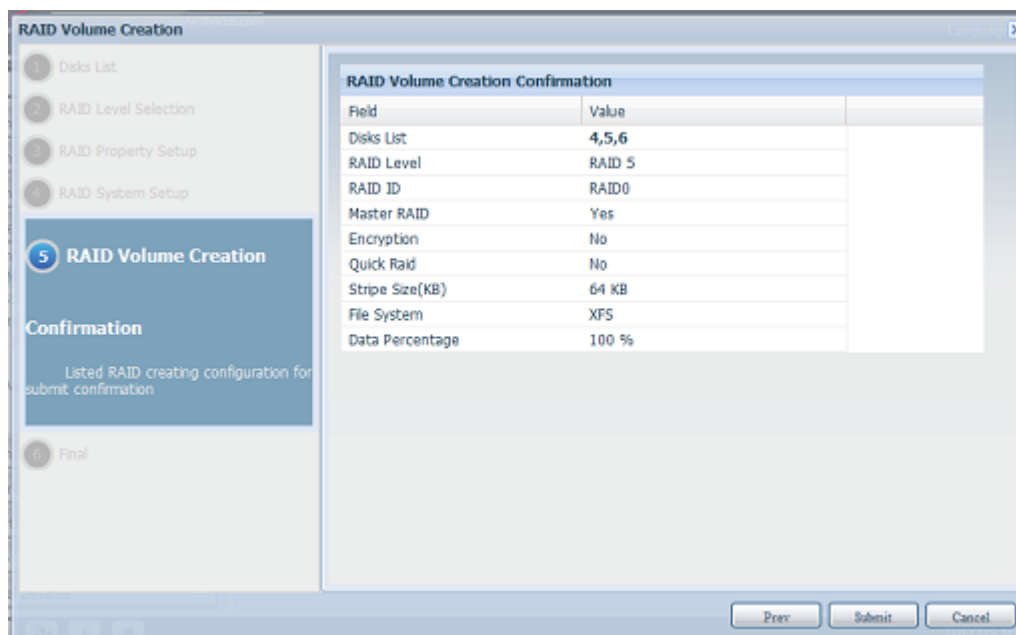

- Press "Yes" for RAID volume creation preparation. Then click "Finish" to start up with RAID volume building.

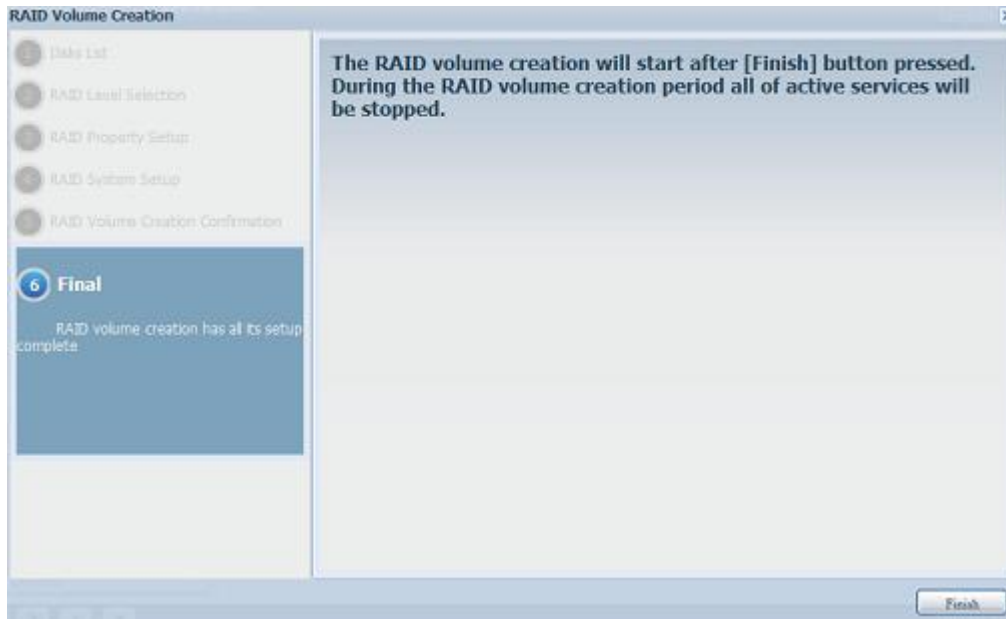

NOTE

Building a RAID volume may be time consuming, depending on the size of hard drives and RAID mode. In general, if the RAID volume building process is up to "RAID Building", then the data volume is accessible.

WARNING

Creating RAID destroys all data in the current RAID volume. The data will be unrecoverable.

RAID Level

You can set the storage volume as **JBOD, RAID 0, RAID 1, RAID 5, RAID 6, RAID 10, RAID 50 or RAID 60 (depending on model).**

Level \ Model	JBOD	RAID 0	RAID 1	RAID 5	RAID 6	RAID 10	RAID 50	RAID 60
N12000 series	•	•	•	•	•	•	•	•
N16000 series	•	•	•	•	•	•	•	•
N12850 series	•	•	•	•	•	•	•	•
N16850 series	•	•	•	•	•	•	•	•
N8900 series	•	•	•	•	•	•	•	•
N6850	•	•	•	•	•	•	•	
N8850	•	•	•	•	•	•	•	•
N10850	•	•	•	•	•	•	•	•
N7700PRO V2	•	•	•	•	•	•	•	
N8800PRO V2	•	•	•	•	•	•	•	•
N7710 series/N7770-10G	•	•	•	•	•	•	•	
N8810U series/N8880U-10G	•	•	•	•	•	•	•	•
N5550	•	•	•	•	•	•		
N5810/N5810PRO	•	•	•	•	•	•		
N4510U series	•	•	•	•	•	•		
N7510	•	•	•	•	•	•	•	

RAID configuration is usually required only when you first set up the device. A brief description of each RAID setting follows:

RAID Levels	
Level	Description
JBOD	The storage volume is a single HDD with no RAID support. JBOD requires a minimum of 1 disk.
RAID 0	Provides data striping but no redundancy. Improves performance but not data safety. RAID 0 requires a minimum of 2 disks.
RAID 1	Offers disk mirroring. Provides twice the read rate of a single disk, but same write rate. RAID 1 requires a minimum of 2 disks.
RAID 5	Data striping and stripe error correction information provided. RAID 5 requires a minimum of 3 disks. RAID 5 can sustain one failed disk.
RAID 6	Two independent parity computations must be used in order to provide protection against double disk failure. Two different algorithms are employed to achieve this purpose. RAID 6 requires a minimum of 4 disks. RAID 6 can sustain two failed disks.
RAID 10	RAID 10 has high reliability and high performance. RAID 10 is implemented as a striped array whose segments are RAID 1 arrays. It has the fault tolerance of RAID 1 and the performance of RAID 0. RAID 10 requires 4 disks. RAID 10 can sustain two failed disks.
RAID 50	RAID 50 combines the straight block-level striping of RAID 0 with the distributed parity of RAID 5. This is a RAID 0 array striped across RAID 5 elements. It requires at least 6 drives.
RAID 60	RAID 60 combines the straight block-level striping of RAID 0 with the distributed double parity of RAID 6. That is, a RAID 0 array striped across RAID 6 elements. It requires at least 8 disks.

WARNING

If the administrator improperly removes a hard disk that should not be removed when RAID status is degraded, all data will be lost.

Edit RAID

On the **RAID Information** screen, press the **Edit** button to go to the **RAID Information** screen.

Using **Edit RAID**, you can select RAID ID and the Spare Disk.

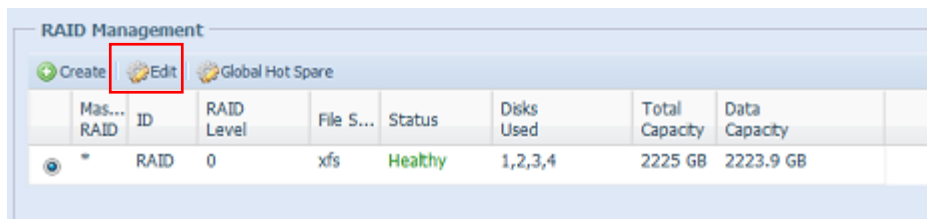

Edit

Disk No.	Capacity (MB)	Model	Status	Used	Spare
1	572,326	WD6000BKHG...	OK	<input checked="" type="checkbox"/>	<input type="checkbox"/>
2	572,326	WD6000BKHG...	OK	<input checked="" type="checkbox"/>	<input type="checkbox"/>
3	572,326	WD6000BKHG...	OK	<input checked="" type="checkbox"/>	<input type="checkbox"/>
4	572,326	WD6000BKHG...	OK	<input checked="" type="checkbox"/>	<input type="checkbox"/>
5	N/A	N/A	N/A	<input type="checkbox"/>	<input type="checkbox"/>
6	953,870	Hitachi HDS72...	OK	<input type="checkbox"/>	<input type="checkbox"/>
7	N/A	N/A	N/A	<input type="checkbox"/>	<input type="checkbox"/>
8	N/A	N/A	N/A	<input type="checkbox"/>	<input type="checkbox"/>

RAID Level: JBOD RAID 0 RAID 1 RAID 5 RAID 6 RAID 10 RAID 50 RAID 60

RAID ID: (Allow 0~9, a~z, A~Z) Master RAID - Take effect after checked box

Encryption: Password: (Allow 1~16 characters) Confirm Password:

Quick Raid: (Enable this setting to enhance RAID creation time if there is no partition existed inside of hard disk)

Stripe Size(KB):

File System:

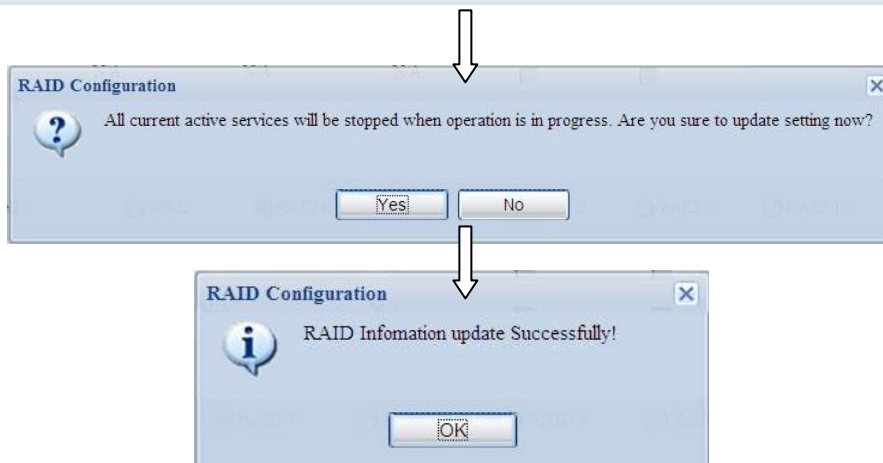

Remove RAID

Click to remove the RAID volume. All user data and iSCSI created in the selected RAID volume will be deleted.

To remove a RAID volume, follow the steps below:

1. On the RAID List screen, select the RAID volume by clicking on its radio button, and click **RAID Information** to open the **RAID Configuration** screen.
2. On the **RAID Configuration** screen, click **Remove RAID**.
3. A confirmation screen will appear, you will have to click "Yes" to complete the "**Remove RAID**" operation.

Edit

Disk No.	Capacity (MB)	Model	Status	Used	Spare
1	572,326	WD6000BKHG...	OK	<input checked="" type="checkbox"/>	<input type="checkbox"/>
2	572,326	WD6000BKHG...	OK	<input checked="" type="checkbox"/>	<input type="checkbox"/>
3	572,326	WD6000BKHG...	OK	<input checked="" type="checkbox"/>	<input type="checkbox"/>
4	572,326	WD6000BKHG...	OK	<input checked="" type="checkbox"/>	<input type="checkbox"/>
5	N/A	N/A	N/A	<input type="checkbox"/>	<input type="checkbox"/>
6	953,870	Hitachi HDS72...	OK	<input type="checkbox"/>	<input type="checkbox"/>
7	N/A	N/A	N/A	<input type="checkbox"/>	<input type="checkbox"/>
8	N/A	N/A	N/A	<input type="checkbox"/>	<input type="checkbox"/>

RAID Level: JBOD RAID 0 RAID 1 RAID 5 RAID 6 RAID 10 RAID 50 RAID 60

RAID ID: (Allow 0~9, a~z, A~Z) Master RAID - Take effect after checked box

Encryption: Password: (Allow 1~16 characters) Confirm Password:

Quick Raid: (Enable this setting to enhance RAID creation time if there is no partition existed inside of hard disk)

Stripe Size(KB):

File System:

WARNING

Remove RAID destroys all data in the selected RAID volume. The data will be unrecoverable.

Global Hot Spare

Up to 5 RAID volumes can be created per system. The global hot spare support can eliminate the redundant disk usage in each RAID volume. Simply select an unused disk from the global hot spare disk list then apply to activate.

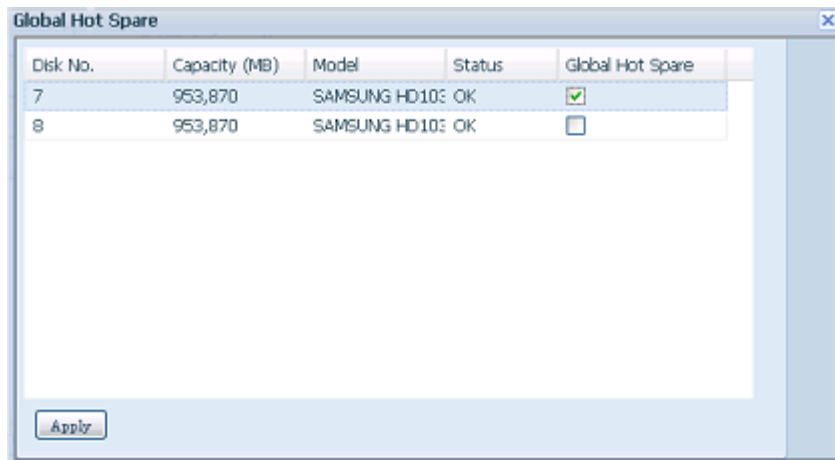

Expanding a RAID

To expand a RAID 1, RAID 5, or RAID 6 volume, follow the steps below:

1. Replace one of the hard drives in the RAID volume and allow it to automatically rebuild.
2. Once rebuilt, you can continue to replace any remaining disks in the RAID array.
3. When you are done replacing hard drives, log on to Web Management. Navigate to **Storage > RAID** to open the **RAID Configuration** screen.
4. On the **RAID Information** screen, click **Edit** to open the **RAID Configuration** screen.
5. On the **RAID Configuration** screen, click **Expand**.

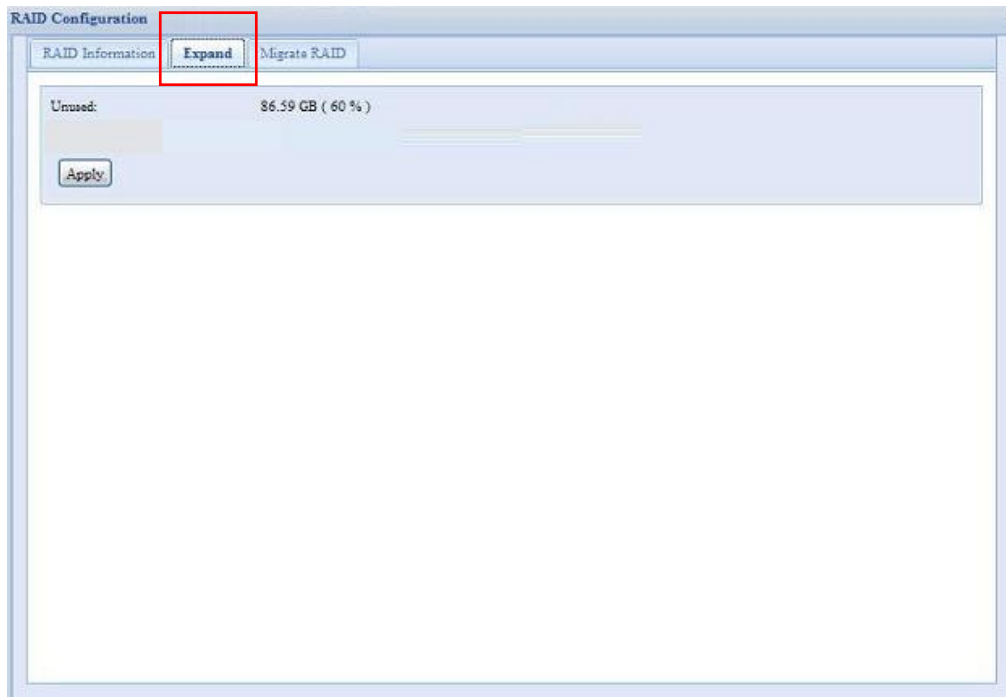

Migrating a RAID

Once a RAID volume has been created, you may want to move it to other physical drives or change the RAID array all together. To migrate a RAID 1, RAID 5, RAID 6, RAID50 or RAID 60 volume, follow the steps below:

1. From the RAID Configuration screen, click **Migrate RAID**.
2. A list of possible RAID migration configurations will be listed. Select the desired migration scheme and click **Apply**.
3. The system will begin migrating the RAID volume.

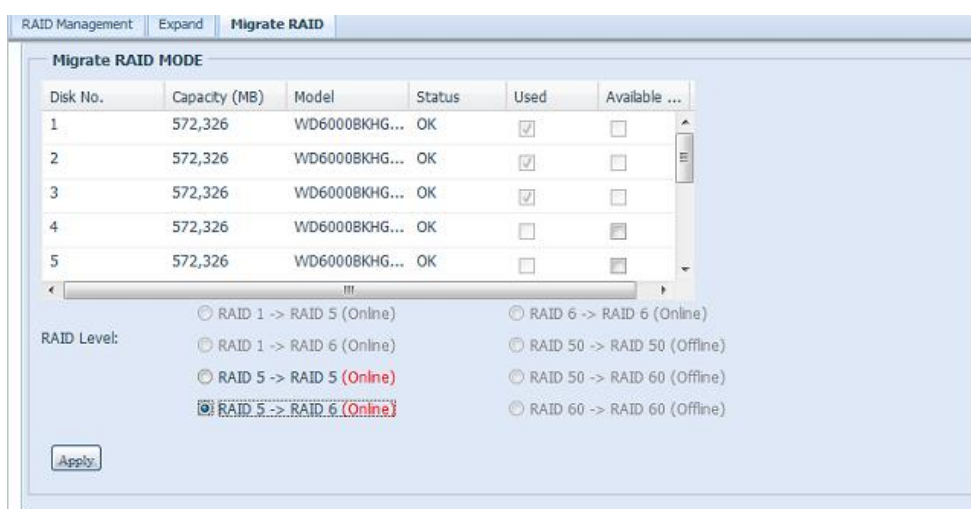

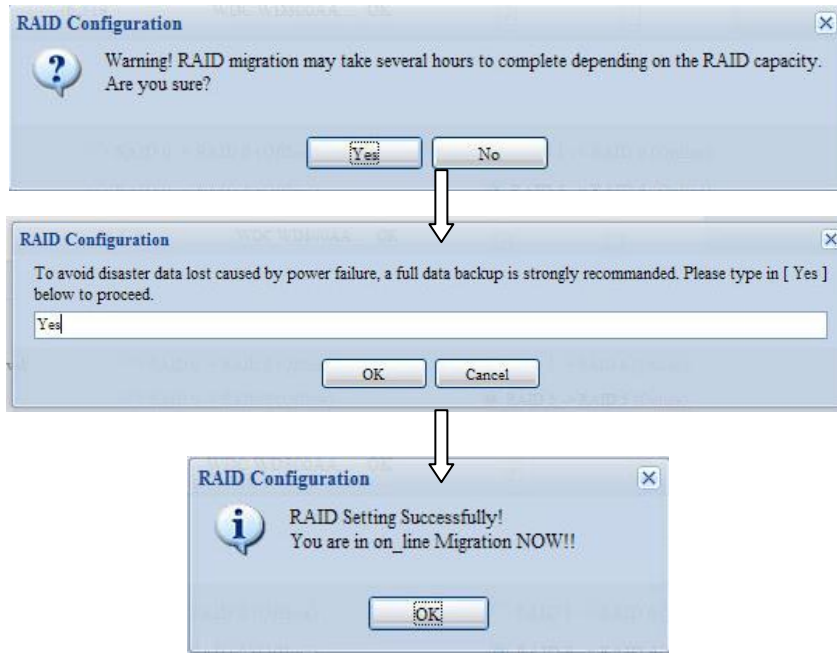

NOTE

- Migrating a RAID volume could take several hours to complete
- The RAID migration feature is available only when it is configurable.

Here is a list of limitation with RAID level migration function:

1. During RAID level migration, it is not permitted to reboot or shutdown system.
2. For RAID migration from **R1 to R5 or R1 to R6**, all services will restart and "iSCSI" volume will be in read only mode but read/write of the "user data" will be possible during the operation.

NOTE

The migration scheme below is based on Thecus IP Storage product's maximum possible combination. For other model which supports less HDD, please refer to the web UI while RAID migration operates.

Below is a table listing of possible RAID migration schemes:

To From	RAID 0	RAID 5	RAID 6
RAID 1		[RAID 1] HDDx2 to [RAID 5] HDDx3 [RAID 1] HDDx2 to [RAID 5] HDDx4 [RAID 1] HDDx2 to [RAID 5] HDDx5 [RAID 1] HDDx2 to [RAID 5] HDDx6 [RAID 1] HDDx2 to [RAID 5] HDDx7 [RAID 1] HDDx2 to [RAID 5] HDDx8HDDx16 [RAID 1] HDDx3 to [RAID 5] HDDx4 [RAID 1] HDDx3 to [RAID 5] HDDx5 [RAID 1] HDDx3 to [RAID 5] HDDx6 [RAID 1] HDDx3 to [RAID 5] HDDx7 [RAID 1] HDDx3 to [RAID 5] HDDx8HDDx16 [RAID 1] HDDx4 to [RAID 5] HDDx5 [RAID 1] HDDx4 to [RAID 5] HDDx6 [RAID 1] HDDx4 to [RAID 5] HDDx7 [RAID 1] HDDx4 to [RAID 5] HDDx8HDDx16 [RAID 1] HDDx5 to [RAID 5] HDDx6 [RAID 1] HDDx5 to [RAID 5] HDDx7 [RAID 1] HDDx5 to [RAID 5] HDDx8HDDx16 [RAID 1] HDDx6 to [RAID 5] HDDx7 [RAID 1] HDDx6 to [RAID 5] HDDx8HDDx16 [RAID 1] HDDx7 to [RAID 5] HDDx8HDDx16	[RAID 1] HDDx2 to [RAID 6] HDDx4 [RAID 1] HDDx2 to [RAID 6] HDDx5 [RAID 1] HDDx2 to [RAID 6] HDDx6 [RAID 1] HDDx2 to [RAID 6] HDDx7 [RAID 1] HDDx2 to [RAID 6] HDDx8HDDx16 [RAID 1] HDDx3 to [RAID 6] HDDx4 [RAID 1] HDDx3 to [RAID 6] HDDx5 [RAID 1] HDDx3 to [RAID 6] HDDx6 [RAID 1] HDDx3 to [RAID 6] HDDx7 [RAID 1] HDDx3 to [RAID 6] HDDx8HDDx16 [RAID 1] HDDx4 to [RAID 6] HDDx5 [RAID 1] HDDx4 to [RAID 6] HDDx6 [RAID 1] HDDx4 to [RAID 6] HDDx7 [RAID 1] HDDx4 to [RAID 6] HDDx8HDDx16 [RAID 1] HDDx5 to [RAID 6] HDDx6 [RAID 1] HDDx5 to [RAID 6] HDDx7 [RAID 1] HDDx5 to [RAID 6] HDDx8HDDx16 [RAID 1] HDDx6 to [RAID 6] HDDx7 [RAID 1] HDDx6 to [RAID 6] HDDx8HDDx16 [RAID 1] HDDx7 to [RAID 6] HDDx8HDDx16
RAID 5	X	[RAID 5] HDDx3 to [RAID 5] HDDx4 [RAID 5] HDDx3 to [RAID 5] HDDx5 [RAID 5] HDDx3 to [RAID 5] HDDx6 [RAID 5] HDDx3 to [RAID 5] HDDx7 [RAID 5] HDDx3 to [RAID 5] HDDx8HDDx16 [RAID 5] HDDx4 to [RAID 5] HDDx5 [RAID 5] HDDx4 to [RAID 5] HDDx6 [RAID 5] HDDx4 to [RAID 5] HDDx7 [RAID 5] HDDx4 to [RAID 5] HDDx8HDDx16 [RAID 5] HDDx5 to [RAID 5] HDDx6 [RAID 5] HDDx5 to [RAID 5] HDDx7 [RAID 5] HDDx5 to [RAID 5] HDDx8HDDx16 [RAID 5] HDDx6 to [RAID 5] HDDx7 [RAID 5] HDDx6 to [RAID 5] HDDx8HDDx16 [RAID 6] HDDx7 to [RAID 5] HDDx8HDDx16	[RAID 5] HDDx3 to [RAID 6] HDDx5 [RAID 5] HDDx3 to [RAID 6] HDDx6 [RAID 5] HDDx3 to [RAID 6] HDDx7 [RAID 5] HDDx3 to [RAID 6] HDDx8HDDx16 [RAID 5] HDDx4 to [RAID 6] HDDx6 [RAID 5] HDDx4 to [RAID 6] HDDx7 [RAID 5] HDDx4 to [RAID 6] HDDx8HDDx16 [RAID 5] HDDx5 to [RAID 6] HDDx7 [RAID 5] HDDx5 to [RAID 6] HDDx8HDDx16 [RAID 5] HDDx6 to [RAID 6] HDDx8HDDx16

RAID 6	X	X	[RAID 6] HDDx4 to [RAID 6] HDDx5 [RAID 6] HDDx4 to [RAID 6] HDDx6 [RAID 6] HDDx4 to [RAID 6] HDDx7 [RAID 6] HDDx4 to [RAID 6] HDDx8HDDx16 [RAID 6] HDDx5 to [RAID 6] HDDx6 [RAID 6] HDDx5 to [RAID 6] HDDx7 [RAID 6] HDDx5 to [RAID 6] HDDx8HDDx16 [RAID 6] HDDx6 to [RAID 6] HDDx7 [RAID 6] HDDx6 to [RAID 6] HDDx8HDDx16 [RAID 6] HDDx7 to [RAID 6] HDDx8HDDx16
--------	---	---	--

NAS Stacking

The Thecus IP storage’s capacity can be expanded even further using the stackable function. With it, users can expand the capacity of their network storage systems up to 5 other stack target volumes which are located in different systems. These can be stacked through single network access like SMB or AFP acting as a share folder type.

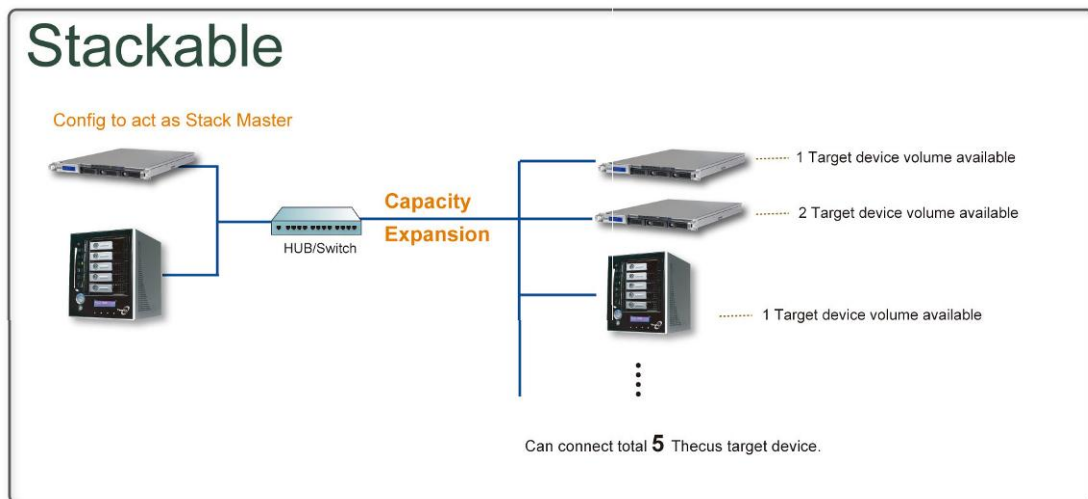

From the main menu, the stackable feature is located under “Storage”. Please refer the figure below for reference.

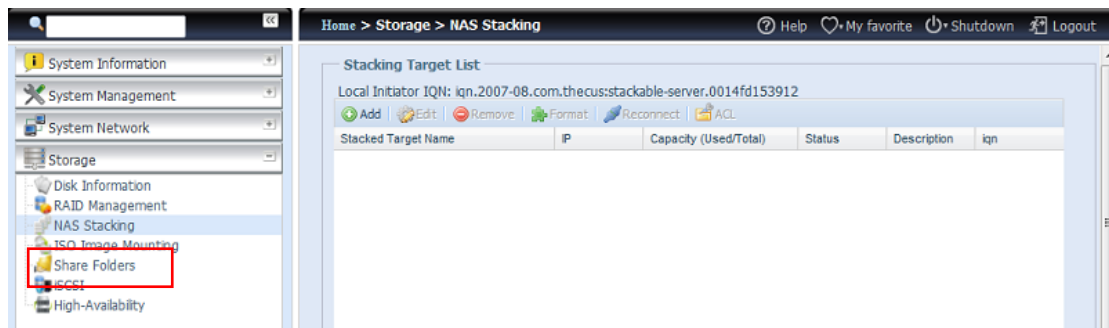

A. Add a Stack Target Volume

From the figure above, click **Add** to access the stackable target device configuration page. Please refer to the figure below:

With the added stack target you can "Enable" or "Disable" the stack target now or later depending on usage required.

Add iSCSI Target (Add Stack Target)

Enable iSCSI Target: Enable Disable

Stackable Target IP:

iqn: ▼

Username:

Password:

Stacked Target Name: (Limit : (0~9, a~z))

Description:

Browseable: yes no

Public: yes no

Stackable will mount the first LUN of the iSCSI target if it has more than one LUN.

Next, input the target IP address of the stackable device and click the **Discovery** button. The system will list available target volumes from the inputted IP address.

Once the volume IP has been set, you may need to input a valid user name and password to validate your access rights. If there is no user name and password needed to access target volume, then leave it blank.

Add iSCSI Target (Add Stack Target)

Enable iSCSI Target: Enable Disable

Stackable Target IP:

iqn: ▼

Username:

Password:

Stacked Target Name: (Limit : (0~9, a~z))

Description:

Browseable: yes no

Public: yes no

Stackable will mount the first LUN of the iSCSI target if it has more than one LUN.

The **Stacked Target name** will become the network share name and will be displayed through network access such as SMB. You may refer to the figure below to see the result. Please note the naming limitation.

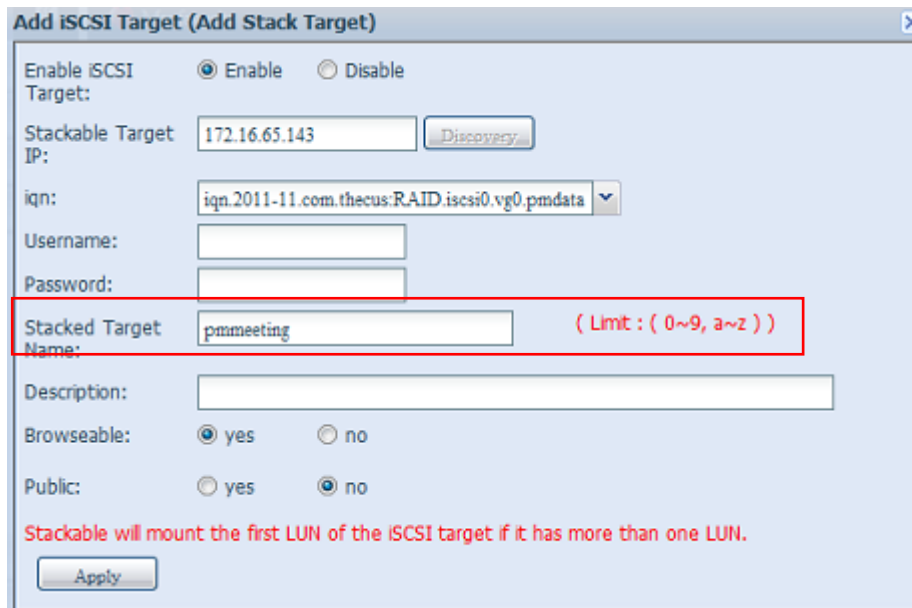

From the figure above, the **Stacked Target name** is "pmmeeting". The figures below show the result before and after via Microsoft Network Access when settings have been completed.

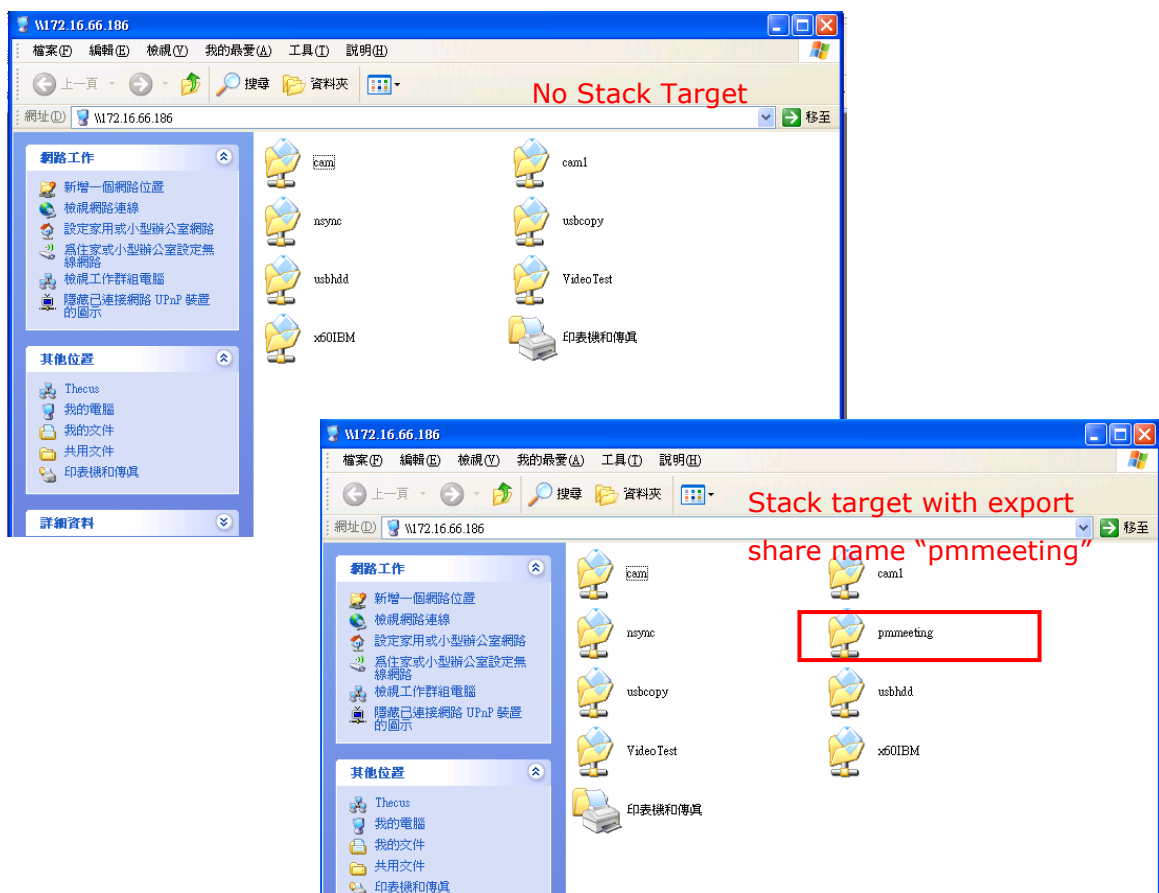

The **Browseable** setting is the same method used for setting a system share folder. It designates whether or not this folder will be visible through web disk. You may refer to the figure below for reference when **Yes** and **No** are selected.

The screenshot shows the 'Add iSCSI Target (Add Stack Target)' dialog box. The 'Enable iSCSI Target' is set to 'Enable'. The 'Stackable Target IP' is '172.16.65.143'. The 'iqn' is 'iqn.2011-11.com.thecus:RAID.iscsi0.vg0.pmdata'. The 'Stacked Target Name' is 'pmmeeting'. The 'Browseable' setting is highlighted with a red box and is set to 'yes'. The 'Public' setting is set to 'no'. A red note at the bottom states: 'Stackable will mount the first LUN of the iSCSI target if it has more than one LUN.' An 'Apply' button is at the bottom.

The **Public** setting will be set the same way as the setting for the system share folder associated with the ACL permission is. If **Public** is set to **Yes**, all users will be able to access it, and **ACL** button will be grayed out. If **Public** is set to **No**, the ACL button will be available in the **Stack Target List** window.

The screenshot shows the 'Add iSCSI Target (Add Stack Target)' dialog box. The 'Browseable' setting is set to 'yes'. The 'Public' setting is highlighted with a red box and is set to 'no'. The rest of the settings are the same as in the previous screenshot. A red note at the bottom states: 'Stackable will mount the first LUN of the iSCSI target if it has more than one LUN.' An 'Apply' button is at the bottom.

Click **Apply** to save your changes.

B. Activate a Stack Target

After your settings have been applied, the system will bring you back to the **Stack Target List** window as shown below. There is one stack target device that has been attached into this stack master.

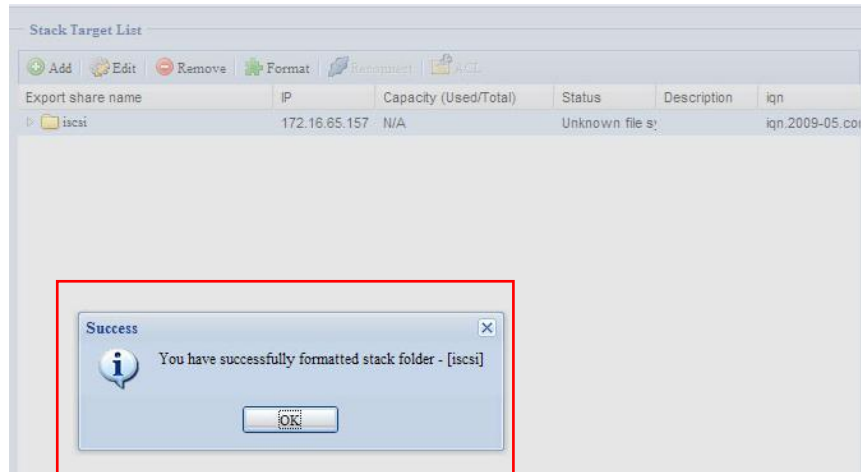

With this newly attached stack target device, you will see the information displayed and also have access to several options to choose from.

In general, if the attached stack target device has been used by another Thecus NAS as stack target volume, then the **Format** item will be display and system will recognize it straight away and display its capacity. Otherwise, the **Format** item will be available and the **Capacity** and **Status** items will show as "N/A" and "Unknown file system" respectively.

Next, click **Format** to proceed with formatting.

After the format is completed, the stack target volume will be created successfully. You will see the volume's capacity and status in the **Stack Target List** screen.

C. Edit a Stack Target

To make any changes to a stack target, click **Edit** for the corresponding stack target, and the system will bring up the following dialogue window:

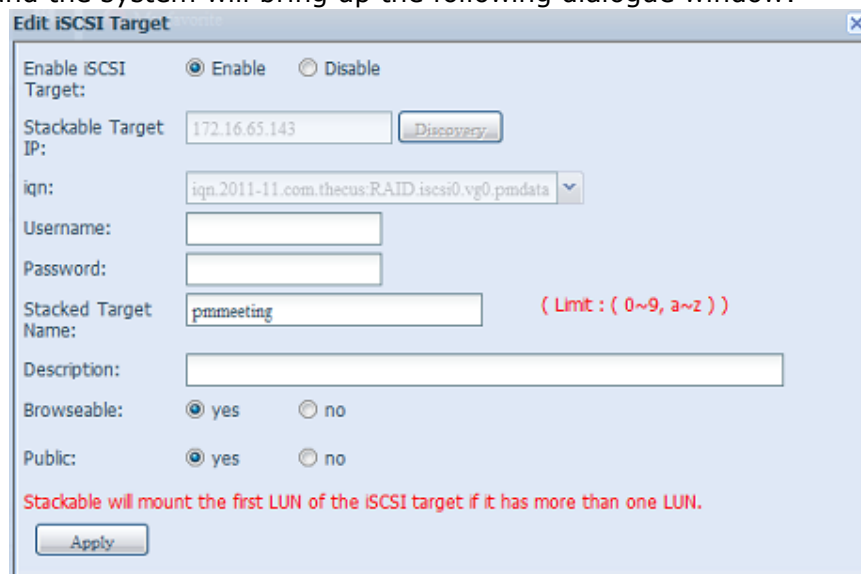

After your changes have been made, click **Apply** to confirm any modifications. Once changes are applied, the associated information will be updated on the **Stack Target List** window.

D. Stack Target ACL

If the stack target **Public** setting set to **Yes**, then the **ACL** button will be grayed out. However, if **Public** setting is set to **No**, then the **ACL** button will be available for you to setup user access permissions for the stack target.

The **ACL** settings will be exactly the same as the system folder that you may have setup previously.

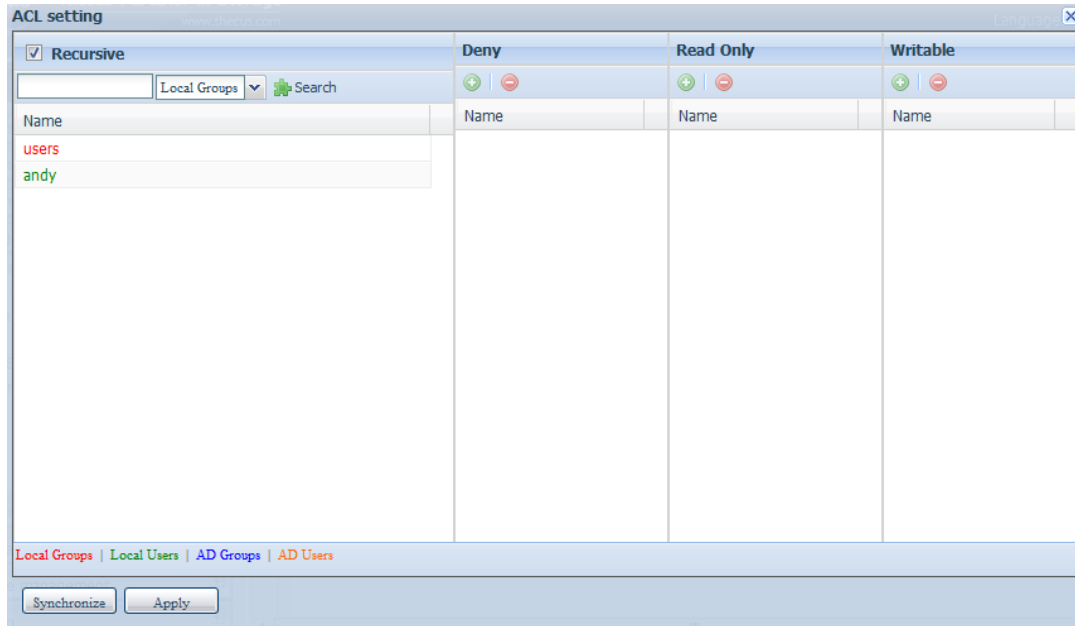

E. Reconnect a Stack Target

This is used to enable stack target devices that may have been disconnected due to a power outage or a disconnected network. When this happens, the **Reconnect** button will become available. To attempt to reconnect the stack target, click **Reconnect**.

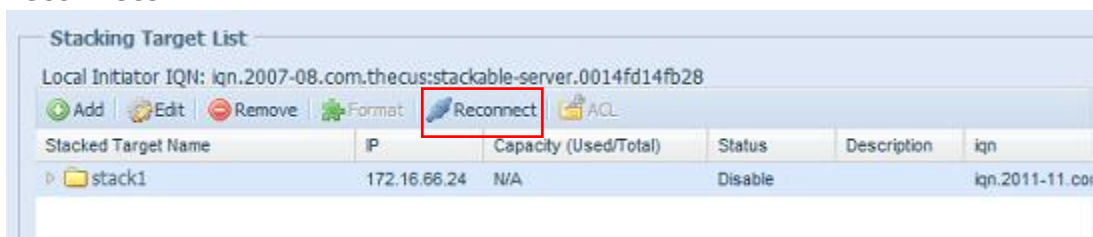

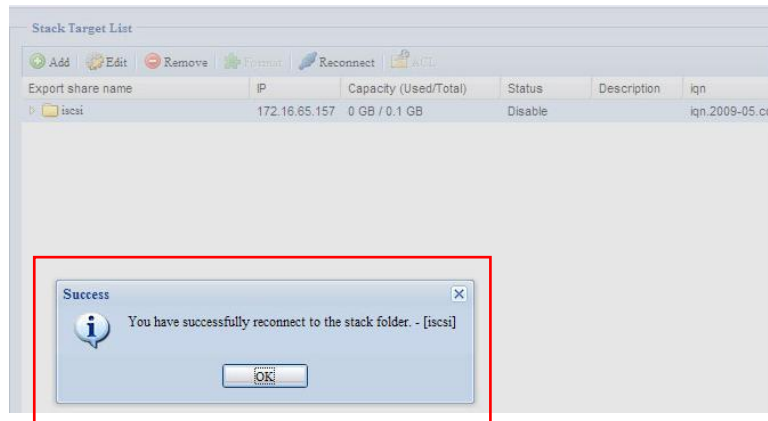

ISO Mount

The ISO Mount feature is a very useful tool from the Thecus products. With it, users can mount an ISO file and have the export name display all the details from the mounted ISO file.

From the main menu, the ISO Mount feature is located under "Storage". Please refer the figure below for reference.

Select the **ISO Image Mounting** function and the ISO Image Mounting window will appear as shown here.

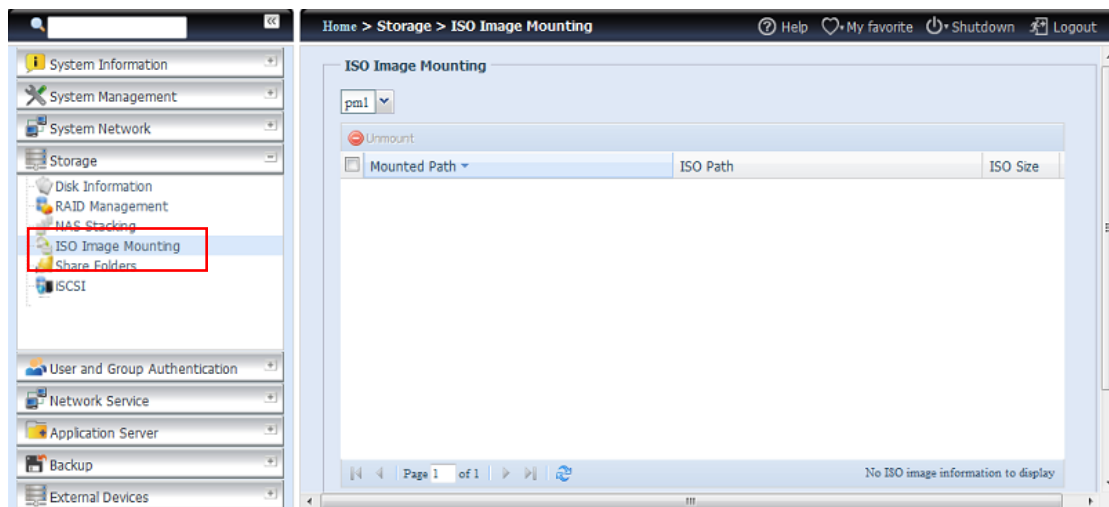

A. Add an ISO file

From the figure above, select an ISO file from the drop down share list.

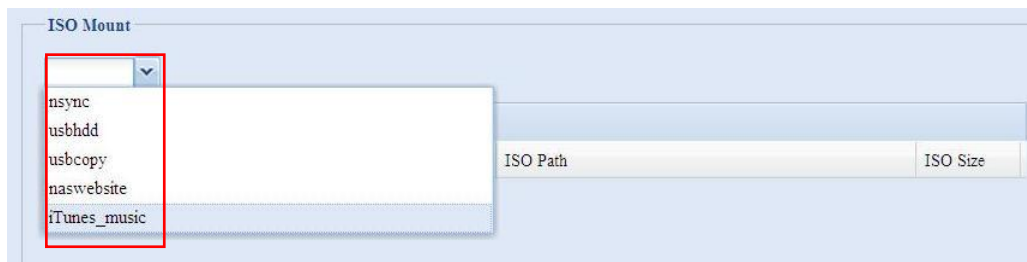

After selection, the system will bring up the Mount table screen for further settings.

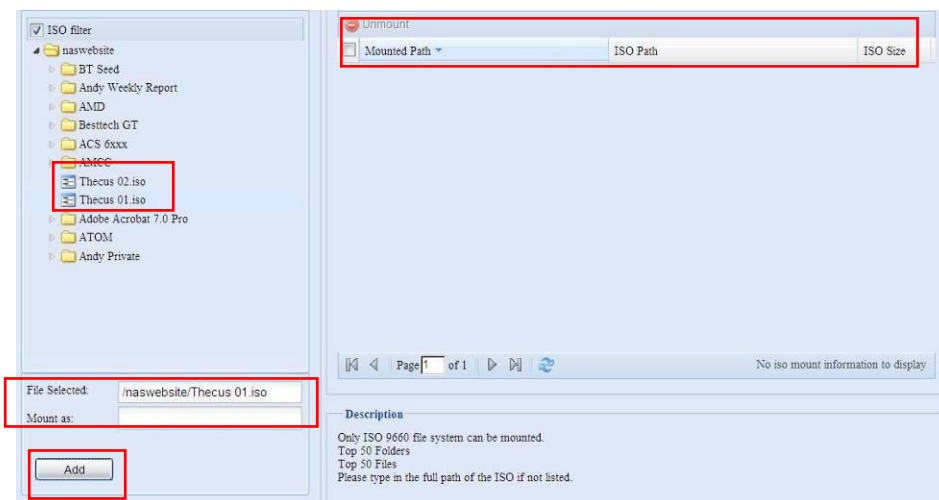
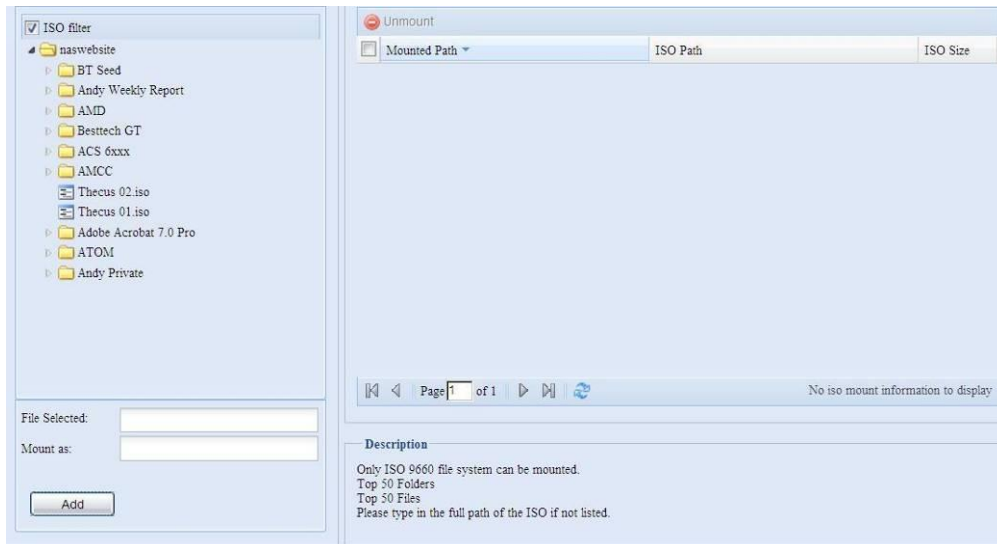

To mount the new ISO file, select one file from the list of files and input the desired mounting name into the "Mount as:" field. Click "ADD" to confirm the completion of the mounting. If nothing is input in the "Mount as" ISO file export name field, the system will automatically give an export name to the ISO file. The mounting name will then be defined by the ISO file name.

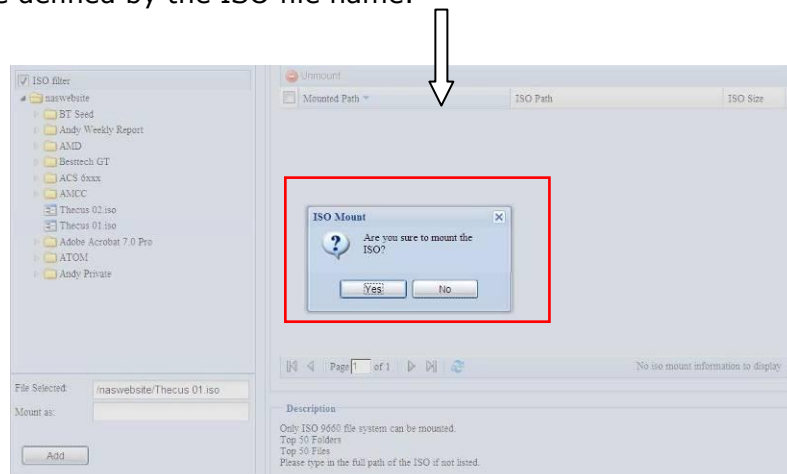

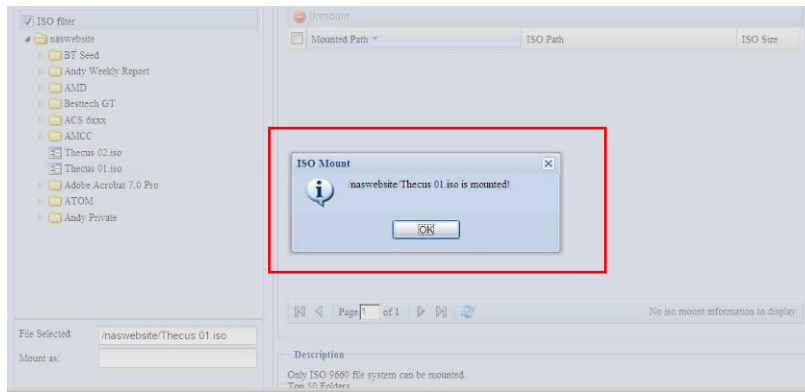

After completion, the page will display all mounted ISO files.

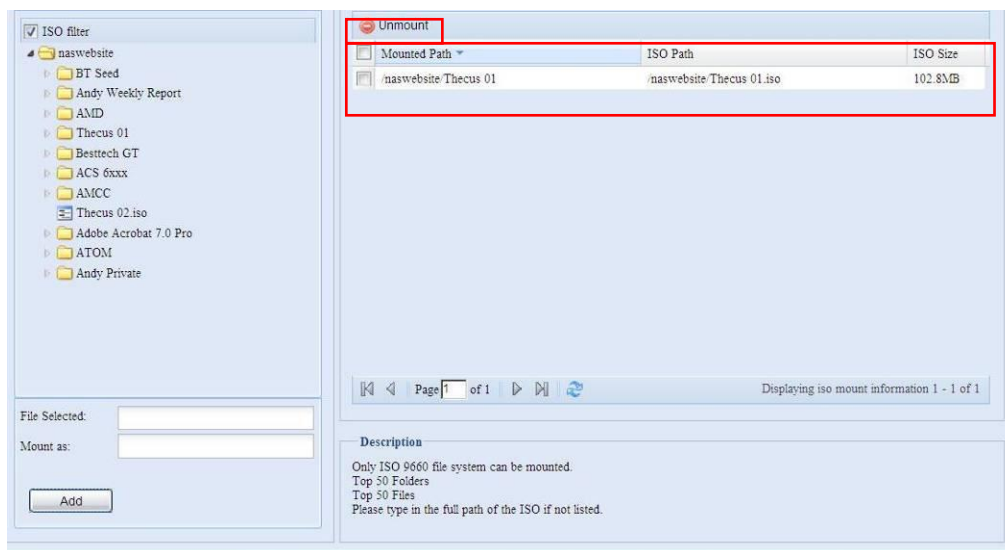

You can click "Unmount" to eliminate a mounted ISO file.

B. Using ISO

The mounted ISO file will be located in the share folder of the same name as the file. Please refer the screen shot below. Here, the ISO file "Thecus 01" wasn't assigned a mounting name, so the system automatically created a folder "Thecus 01".

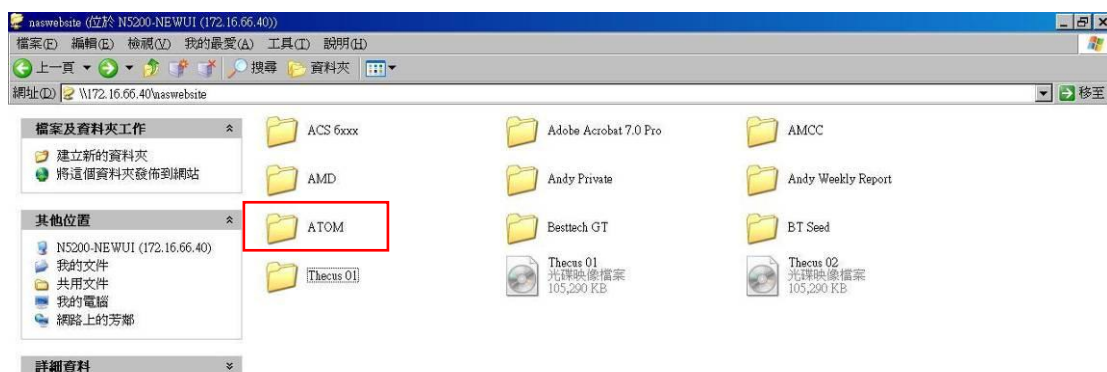

Share Folder

From the **Storage** menu, choose **Share Folders**, and the **Shared Folder** screen appears. This screen allows you to create and configure folders on the Thecus IP storage volume.

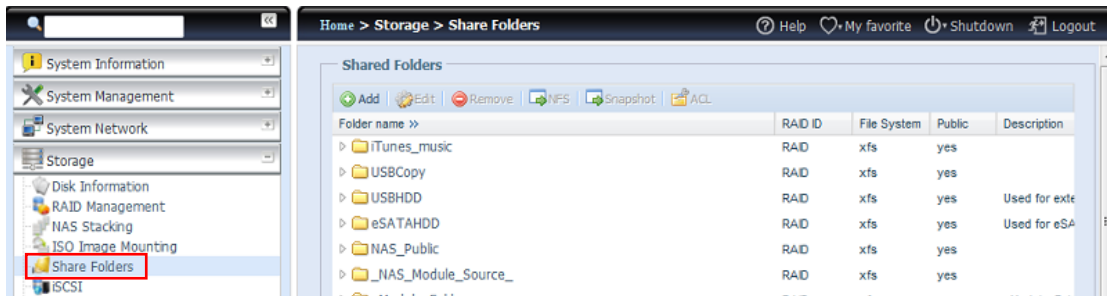

Adding Folders

On the **Folder** screen, press the **Add** button and the **Add Folder** screen appears. This screen allows you to add a folder. After entering the information, press **Apply** to create new folder.

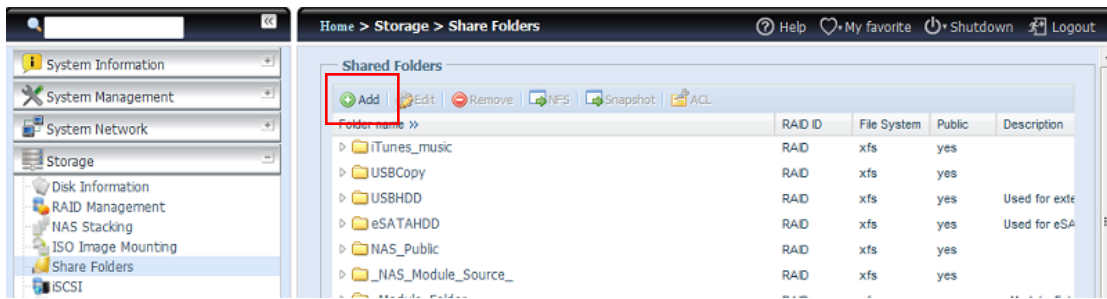

add folder

RAID ID:

Folder name:

Description:

Browseable: Yes No

Public: Yes No

Add Folder	
Item	Description
RAID ID	RAID volume where the new folder will reside.
Folder Name	Enter the name of the folder.
Description	Provide a description the folder.
Browseable	Enable or disable users from browsing the folder contents. If Yes is selected, then the share folder will be browseable.
Public	Admit or deny public access to this folder. If Yes is selected, then users do not need to have access permission to write to this folder. When accessing a public folder via FTP, the behavior is similar to anonymous FTP. Anonymous users can upload/download a file to the folder, but they cannot delete a file from the folder.
Apply	Press Apply to create the folder.

NOTE

Folder names are limited to 60 characters. Systems running Windows 98 or earlier may not support file names longer than 15 characters.

Modify Folders

On the **Folder** screen, press the **Edit** button and the **Modify Folder** screen appears. This screen allows you to change folder information. After entering the information, press **Apply** to save your changes.

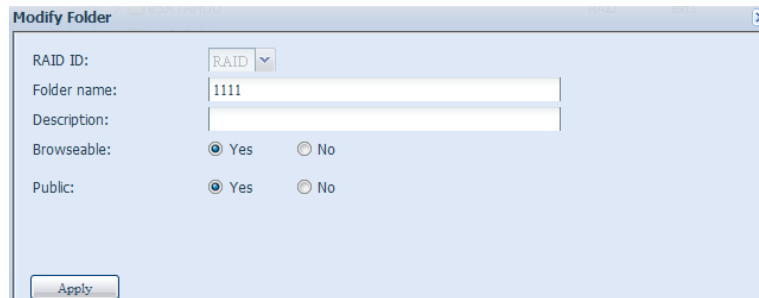

Modify Folder	
Item	Description
RAID ID	RAID volume where the folder will reside.
Folder Name	Enter the name of the folder.
Description	Provide a description the folder.
Browseable	Enable or disable users from browsing the folder contents. This setting will only apply while access via SMB/CIFS and web disk.
Public	Admit or deny public access to this folder.

Remove Folders

To remove a folder, press the **Remove** button from the specified folder row. The system will confirm folder deletion. Press **Yes** to delete the folder permanently or **No** to go back to the folder list.

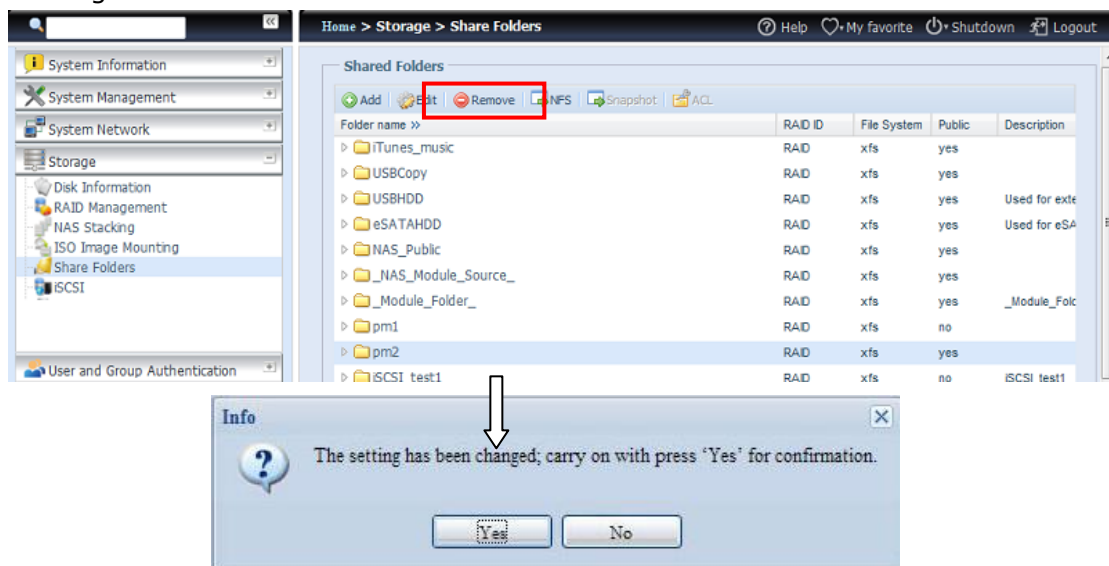

WARNING

All the data stored in the folder will be deleted once the folder is deleted. The data will not be recoverable.

NFS Share

To allow NFS access to the share folder, enable the **NFS Service**, and then set up hosts with access rights by clicking **Add**.

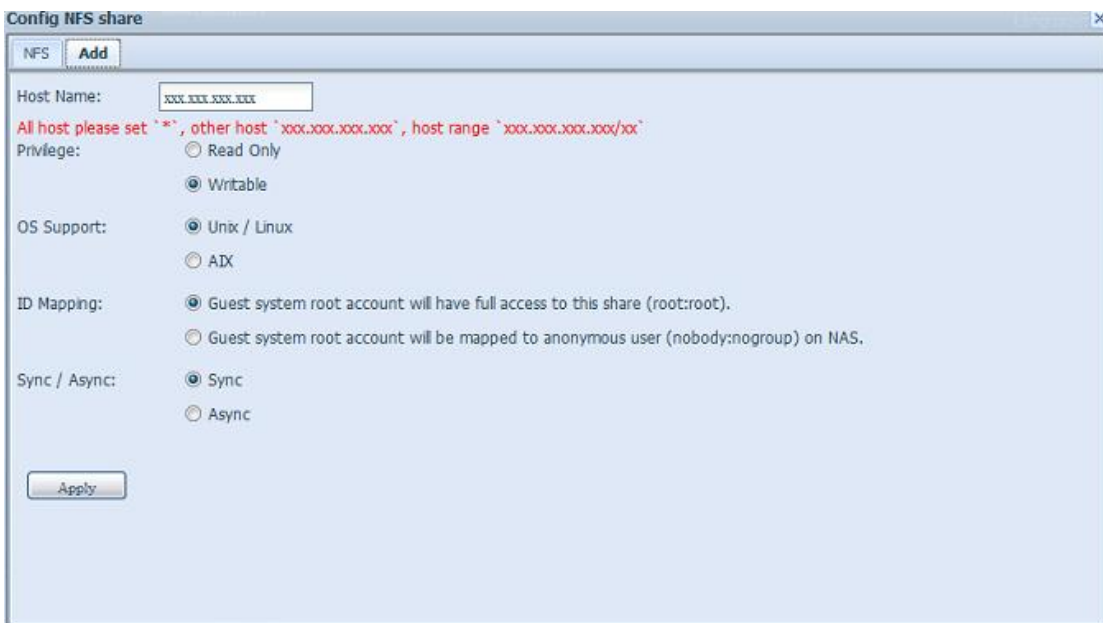
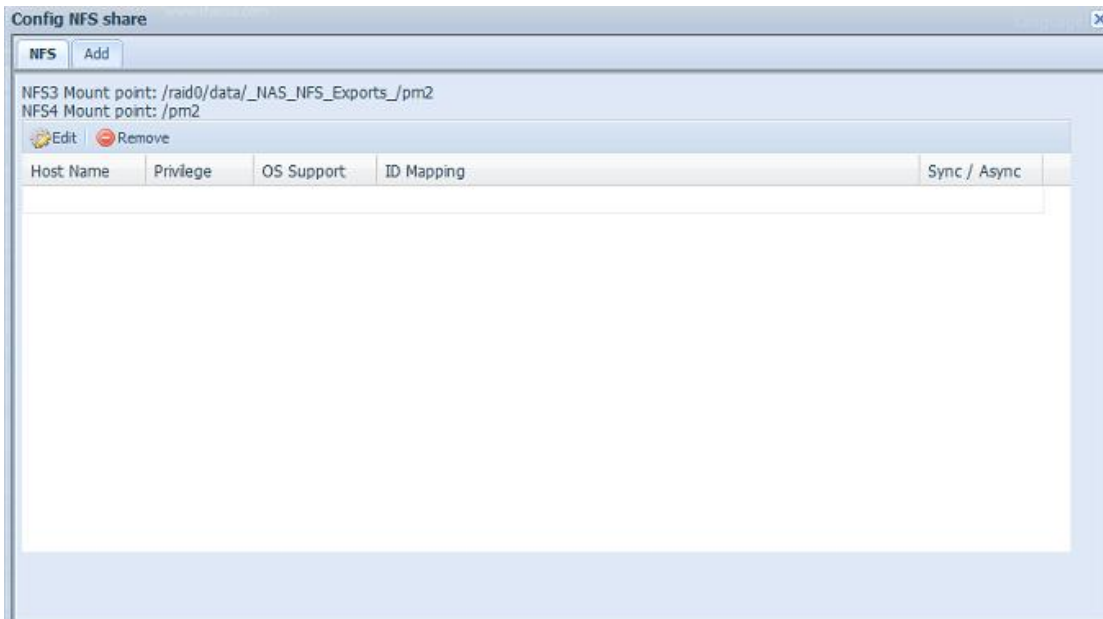

NFS Share	
Item	Description
Hostname	Enter the name or IP address of the host
Privilege	Host has either read only or writeable access to the folder.
OS Support	There are two selections available: <ul style="list-style-type: none"> • Unix / Linux System • AIX (Allow source port > 1024) Choose the one which best fits your needs.
ID Mapping	There are three selections available: <ul style="list-style-type: none"> • Guest system root account will have full access to this

	<p>share (root:root).</p> <ul style="list-style-type: none"> • Guest system root account will be mapped to anonymous user (nobody:nogroup) on NAS. • All user on guest system will be mapped to anonymous user (nobody:nogroup) on NAS. <p>Choose the one which best fits your needs.</p>
Sync / Async	Choose to determine the data "Sync" at once or "Async" in arranged batch.
Apply	Click to save your changes.

Folder and sub-folders Access Control List (ACL)

On the Folder screen, press the **ACL** button, and the **ACL setting** screen appears. This screen allows you to configure access to the specific folder and sub-folders for users and groups. Select a user or a group from the left hand column and then choose **Deny**, **Read Only**, or **Writable** to configure their access level. Press the **Apply** button to confirm your settings.

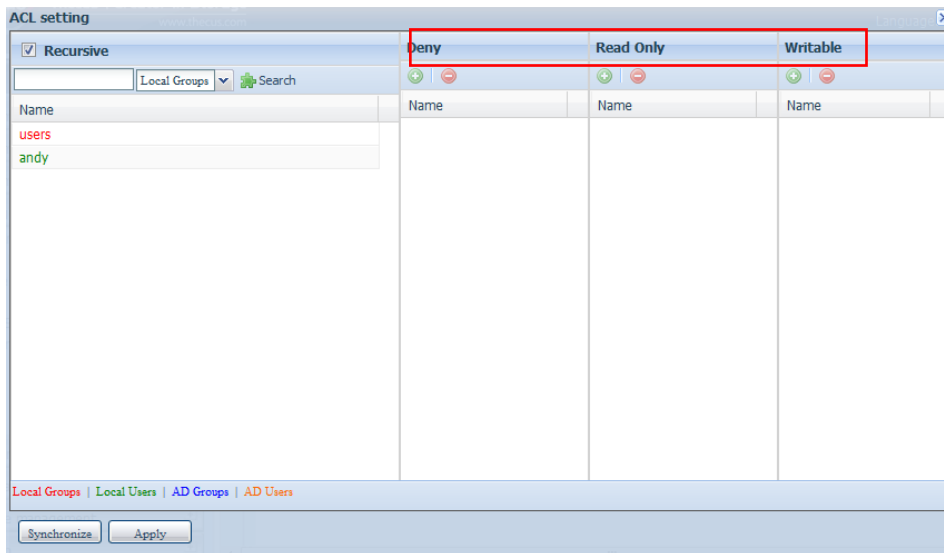
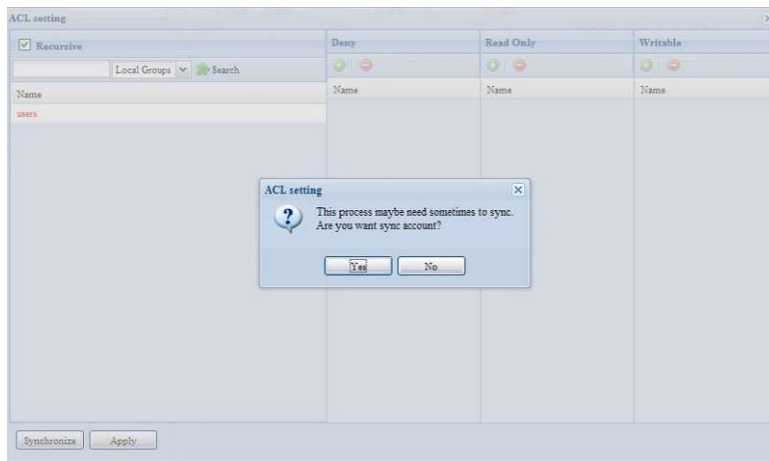

ACL setting	
Item	Description
Deny	Denies access to users or groups who are displayed in this column.
Read Only	Provides Read Only access to users or groups who are displayed in this column.

Writable	Provides Write access to users or groups who are displayed in this column.
Recursive	Enable to inherit the access right for all its sub-folders.

To configure folder access, follow the steps below:

1. On the **ACL** screen, all network groups and users are listed in the left hand column. Select a group or user from this list.
2. With the group or user selected, press one of the buttons from the three access level columns at the top. The group or user then appears in that column and has that level of access to the folder.
3. Continue selecting groups and users and assigning them access levels using the column buttons.
4. To remove a group or user from an access level column, press the **Remove**  button in that column.
5. When you are finished, press **Apply** to confirm your ACL settings.

NOTE

If one user has belonged to more than one group with different privilege, then the priority of the privilege will be as followed:
Deny > Read Only > Writable

To setup sub-folders ACL, click on "▶" symbol to extract sub folders list as screen shot shows below. You may carry on with same steps as share level ACL setting.

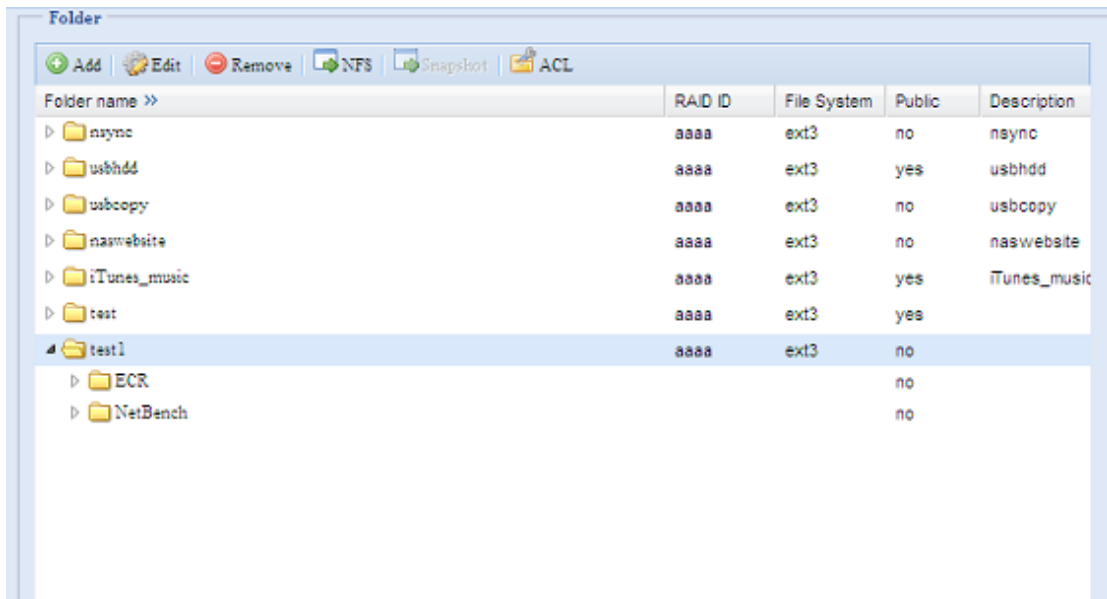

NOTE

The ACL can only be set for share and sub-folders level, not for files.

The ACL screen also allows you to search for a particular user. To do this, follow the steps below:

1. In the blank, enter the name of the user you would like to find.

- From the drop down select the group you would like to search for the user in.
- Click **Search**.

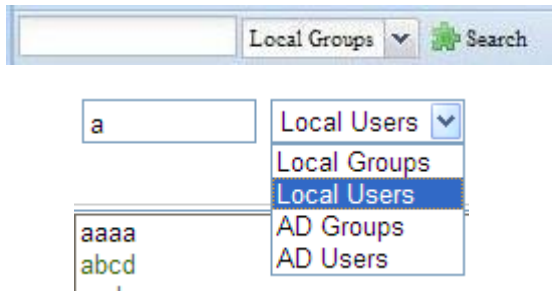

NOTE The system will list up to 1,000 users from the chosen category. To narrow your search, enter a search term in the blank provided.

Snapshot

SMB and enterprise Thecus IP storage systems are now capable of saving 16 Snapshot versions of files and folders. For Snapshot to function, a "BTRFS" file system is required.

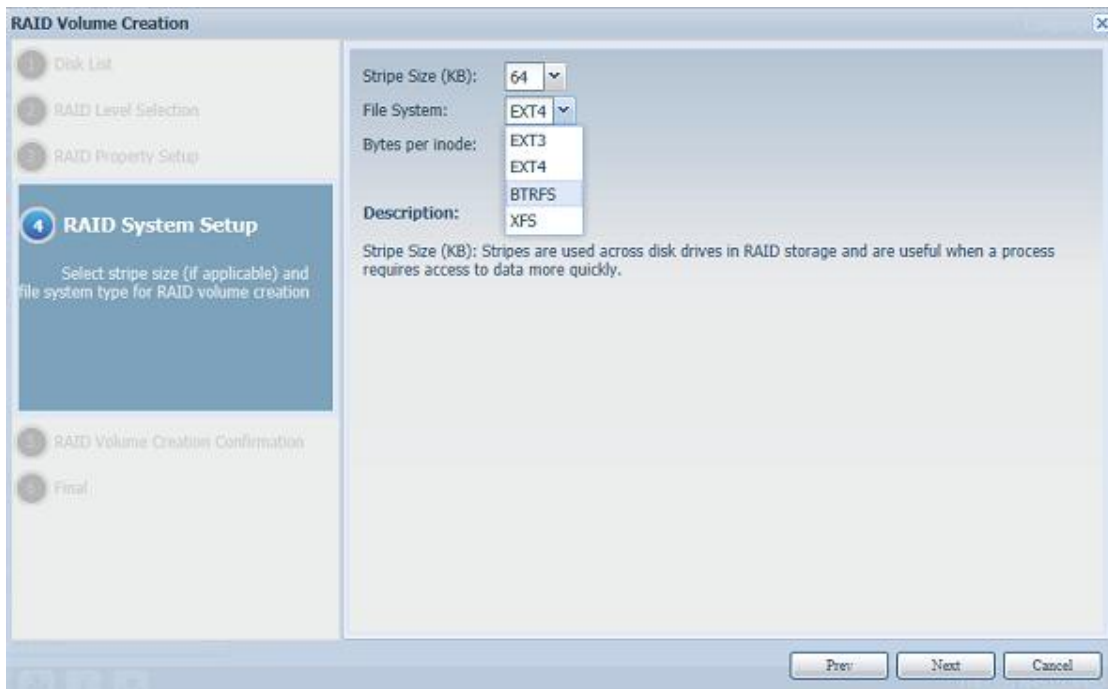

Any folder using a "BTRFS" file system is capable of being included in the Snapshot function. In the "Share Folder" submenu, the Snapshot button is available in the tool bar.

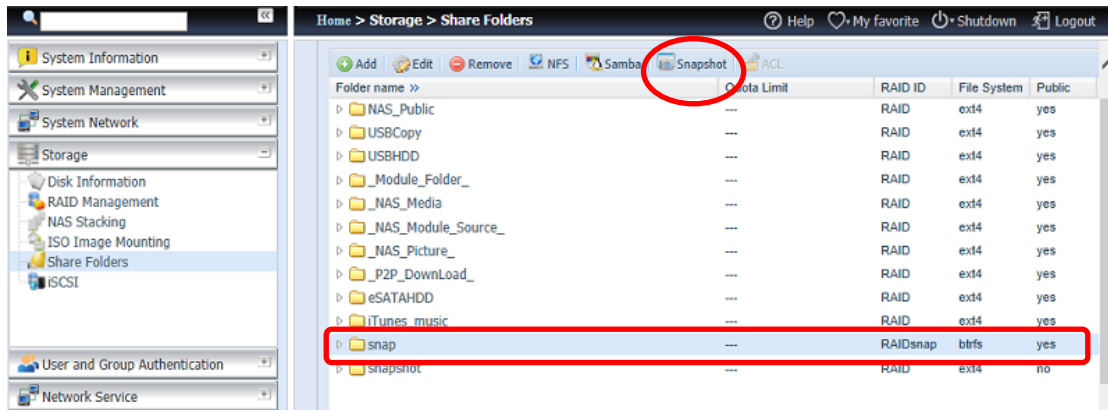

Taking a Snapshot

Click on the "Snapshot" button. The management screen will then appear as below for the associated folder.

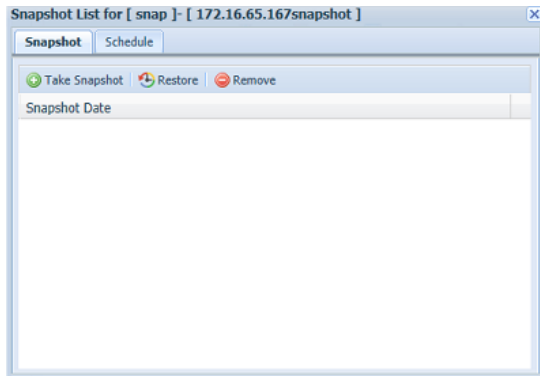

To manually take a Snapshot, simply click "Take Snapshot" and the Snapshot history will be listed. It can store up to 16 versions.

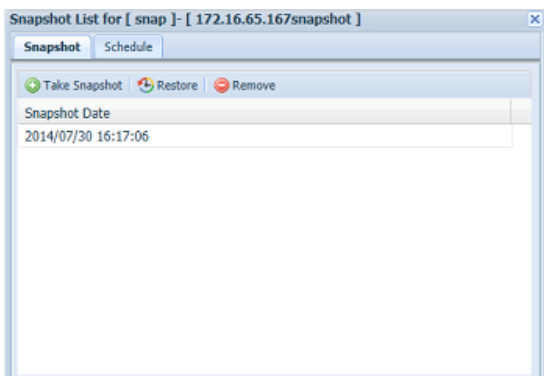

To locate where the Snapshot files or folders are stored, please browse to \\System_IP\Snapshot. Please note that you will need to have the relevant folder permissions enabled for your account.

Besides manual Snapshots, this feature also allows for scheduled backups. Click on "Schedule" and the setup screen will appear. Check "Enable Snapshot Schedule"

and select the desired Snapshot interval. Options include Daily, Weekly, or Monthly.

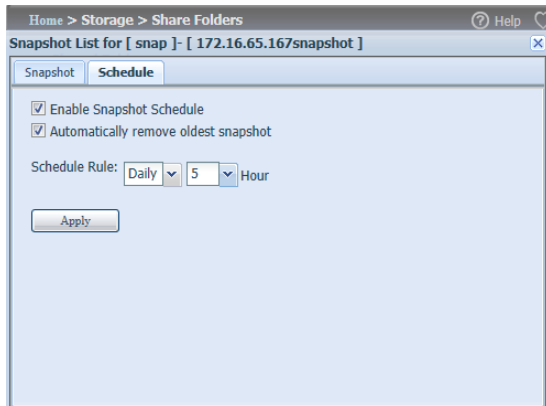

Since files and folders are limited to 16 Snapshots versions, the "Automatically remove oldest Snapshot" option allows for the removal of the oldest version automatically once the limit is reached.

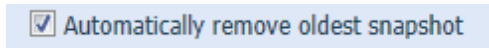

Snapshot Restore

To restore a Snapshot, simply select the desired version from list and click "Restore". Once the restore confirmation has been made, the selected Snapshot will overwrite the current associated file or folder.

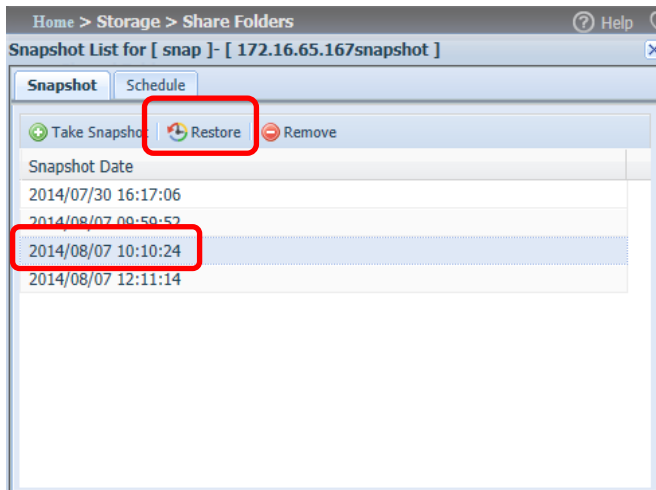

The other way to restore a recorded Snapshot version is manually by browsing to the "Snapshot" folder via SAMBA ([\\System_IP/Snapshot](http://System_IP/Snapshot)). All Snapshot versions are stored here, and you can copy or paste to restore a version manually.

For example, the NAS system at 172.16.65.167 has a folder named "snap" with a Snapshot version backed up. If the user were to browse to [\\172.16.65.167/Snapshot](http://172.16.65.167/Snapshot), the following details would be visible:

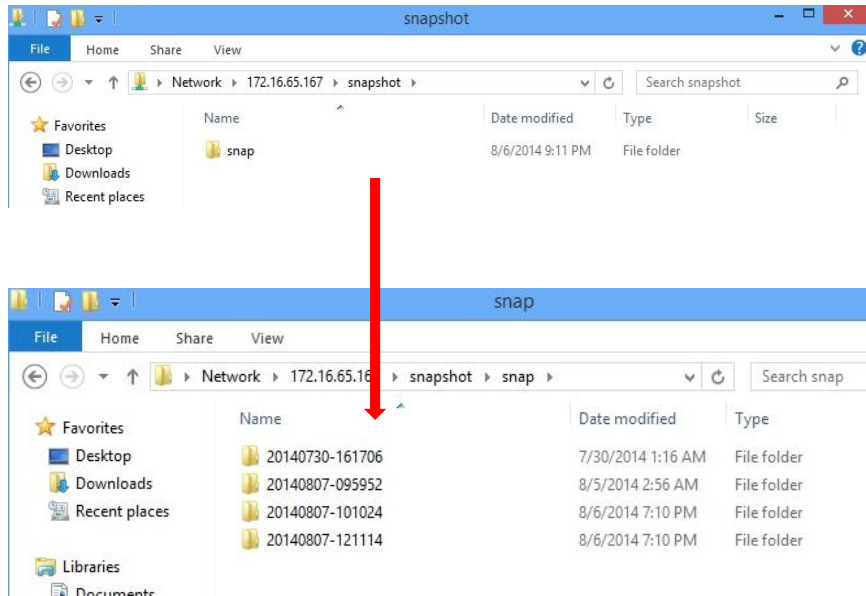

NOTE To access the Snapshot folder, a user requires the relevant authentication rights.

NOTE If the Snapshot folder is used for iSCSI purposes, it can only be restored from the WebUI (i.e. through the Snapshot feature) and cannot be done manually.

Snapshot Removal

To remove a Snapshot, simply select the desired version from list and click "Remove".

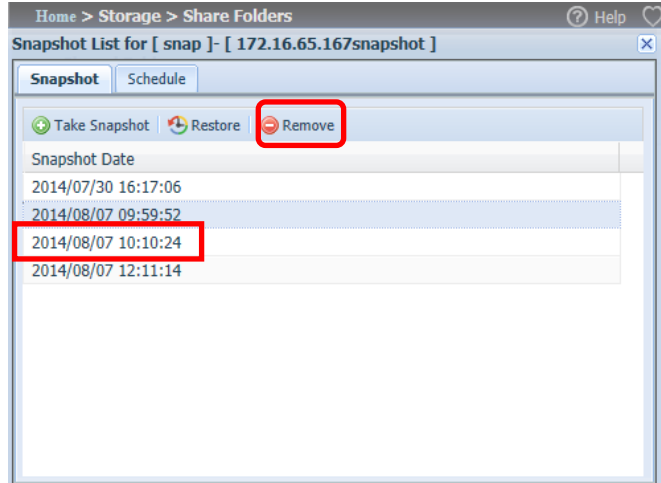

iSCSI

You may specify the space allocated for iSCSI. See the table below to the allowed iSCSI target number per system:

Model	N8900V N6850 N5550 N4510U series N7510	N8800PRO N12000V N16000V N7700PRO V2 N8800PRO V2 N7710 series N8810U series N10850 N8850 N5810 N5810PRO	N8900 N12000 N16000 N12000PRO N16000PRO N7770-10G N8880U-10G N12850 N16850
Allowed iSCSI volume	15	25	50

The screenshot displays the iSCSI configuration interface. It is divided into three main sections:

- RAID Management:** A table showing RAID details.

Master RAID	ID	RAID Level	Status	Disks Used	Total Capacity	Data Capacity	File System
*	RAID	0	Healthy	1,2,3,4	2225	12.8 GB / 2223.9 GB	xfs
- iSCSI Support:** A section with radio buttons for 'Enable' and 'Disable' (selected), and an 'Apply' button.
- iSCSI Target:** A section containing two sub-tables:
 - iSCSI Target Table:**

Name	Status
test1	Disabled
 - LUN Table:**

Name	Capacity(GB)	LUN Allocation
test101	2	Instant Allocation

iSCSI Target

To add iSCSI target volume, click **iSCSI** with associated RAID volume from its drop down list and select the desired RAID volume.

iSCSI Target	
Item	Description
Add	Click to allocate space to iSCSI target from associated RAID volume.
Modify	Click this to modify the iSCSI Target.
Advanced	There are 3 options (iSCSI CRC/Checksum, Max Connections, Error Recovery Level) These currently allow

	the Admin to Enable/Disable the Thecus IP storage associated with the iSCSI setting.
Delete	Click this to delete the iSCSI Target.

Allocating Space for iSCSI Volume

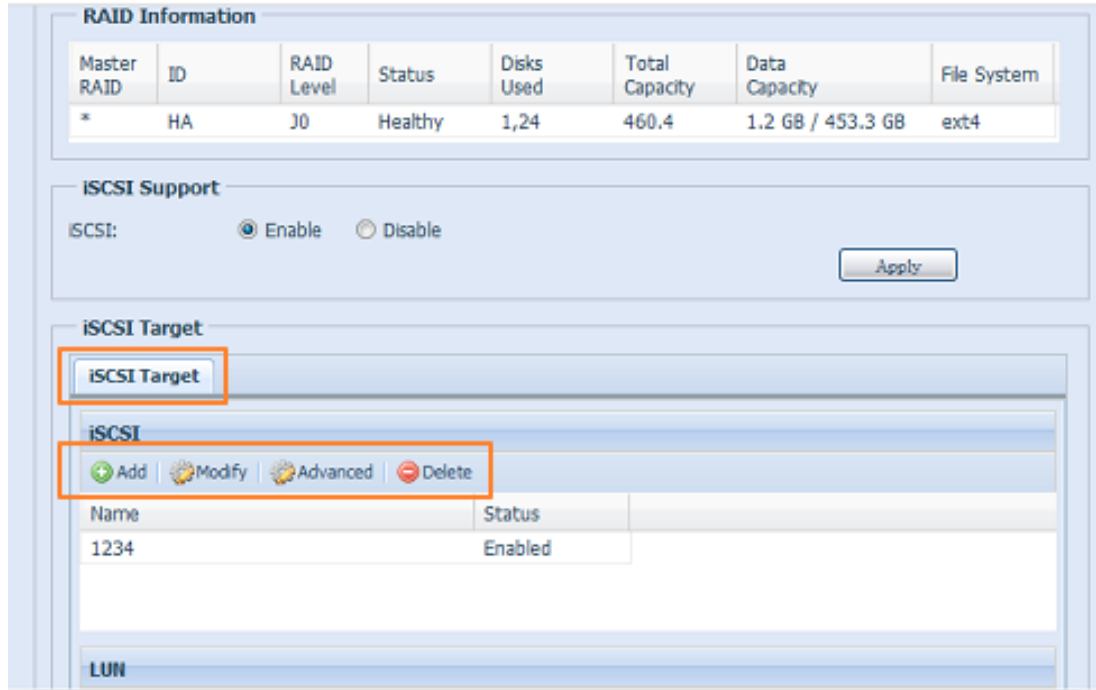

To allocate space for an iSCSI target on the current RAID volume, follow the steps below:

1. Under the **iSCSI Target List**, select **iSCSI Target** then **click Add**. The **Create iSCSI Volume** screen appears.

Create iSCSI Volume

iSCSI Target Volume: Enable Disable

Target Name: Limit:(0~9, a~z)

iqn_Year: 2010

iqn_Month: 12

Authentication: None CHAP

Username: Limit:(0~9, a~z, A~Z)

Password: Limit:(0~9, a~z, A~Z,length between 12~16)

Password Confirm:

Mutual CHAP

Username: Limit:(0~9, a~z, A~Z)

Password: Limit:(0~9, a~z, A~Z,length between 12~16)

Password Confirm:

Create LUN

RAID ID: RAID

LUN Allocation: Thin-Provision Instant Allocation

LUN Name: Limit:(0~9, a~z)

Unused: 363 GB

Allocation: 1 GB

LUN ID: 0

iSCSI Block size: 512 Bytes(For older version)

Description

The iSCSI block size can be set under system advance option, default is 512 Bytes.
Please use [4K] block size while more than 2TB capacity will be configured in Windows XP.
Please use [512 Bytes] block size for application like VMware etc.

OK

Create iSCSI Volume	
Item	Description
iSCSI Target Volume	Enable or Disable the iSCSI Target Volume.
Target Name	Name of the iSCSI Target. This name will be used by the Stackable NAS function to identify this export share.
iqn_Year	Select the current year from the dropdown.
Iqn_Month	Select the current month from the dropdown.
Authentication	You may choose CHAP authentication or choose None.
Username	Enter a username.
Password	Enter a password.
Password Confirm	Reenter the chosen password
Mutual CHAP	With this level of security, the target and the initiator authenticate each other.
Username	Enter a username.
Password	Enter a password.
Password Confirm	Reenter the chosen password
RAID ID	ID of current RAID volume.
LUN Allocation	Two modes can be choose from: Thin-provision : iSCSI thin-provisioning shares the available physical capacity to multiple iSCSI target volumes. It allows virtual capacity to be assigned to targets prior to adding physical space when it has run out. Instant Allocation: Allocate available physical capacity to iSCSI target volumes.
LUN Name	Name of the LUN.
Unused	Unused space on current RAID volume.
Allocation	Percentage and amount of space allocated to iSCSI volume.

LUN ID	Specific Logic unit ID number.
iSCSI Block size	The iSCSI block size can be set under system advance option, default is 512 Bytes. [4K] block size while more than 2TB capacity will be configured in Windows XP. [512 Bytes] block size for application like VMware etc.

NOTE

Be sure the iSCSI target volume has been enabled or it will not list out while using Initiator to get associated iSCSI target volumes.

NOTE

The iSCSI target volume creation will associate at least one LUN together. It can be assigned either "Thin-Provisioning" or "Instant Allocation".

2. Enable the **iSCSI Target Volume** by selecting **Enable**.
3. Enter a **Target Name**. This will be used by the **Stackable NAS** function to identify this export share.
4. Choose the current year from the **Year** dropdown.
5. Choose the current month from the **Month** dropdown.
6. Choose to enable **CHAP** authentication or choose **None**.
7. If you've enabled CHAP authentication, enter a **username** and a **password**. Confirm your chosen password by reentering it in the **Password Confirm** box.
8. Choose **Thin-Provision** or **Instant Allocation**
9. Enter a **LUN Name**.
10. Designate the percentage to be allocated from the **Allocation** drag bar.
11. When iSCSI target volume has been created, the LUN ID is configurable from 0 to 254 with a default of the next available number in ascending numerical order. The LUN ID is unique and cannot be duplicated.
12. Choose [**4K**] **block size** to have iSCSI target volume over 2TB barrier or [**512 Bytes**] **block size** in some application needed.
13. Click **OK** to create the iSCSI volume.

Modify iSCSI Volume

To modify iSCSI target on the current RAID volume, follow the steps below:

1. Under the **iSCSI Target List**, click **Modify**. The **Modify iSCSI Volume** screen appears.

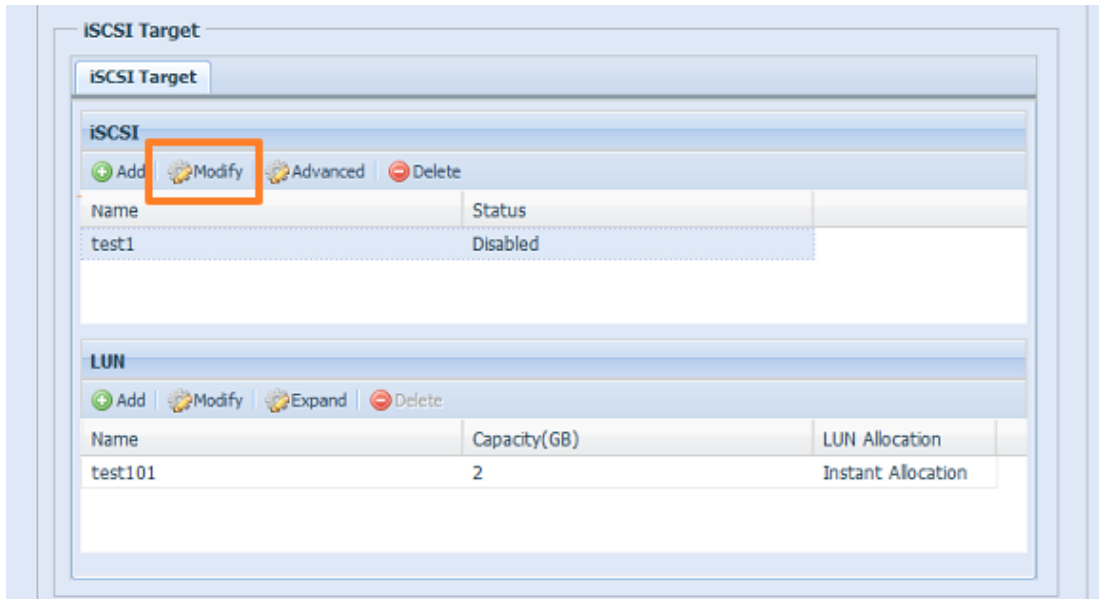

2. Modify your settings. Press **ok** to change.

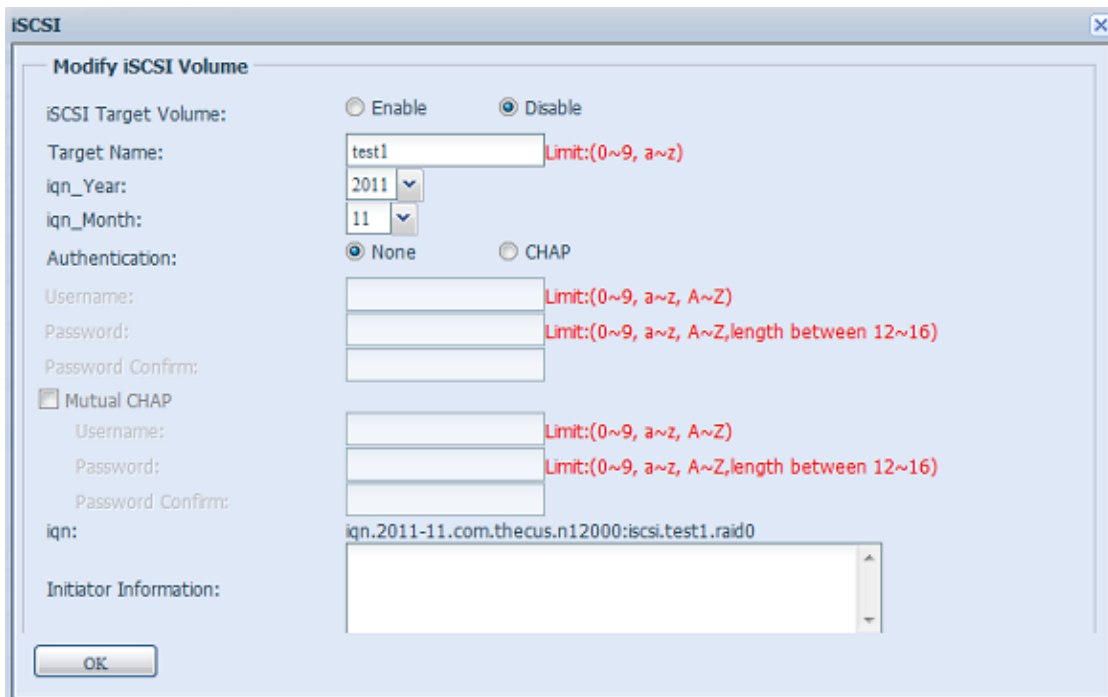

Expand Volume

The iSCSI volume is now able to expand its capacity from unused space (Instant Allocation mode only). From the volume list, simply select the iSCSI volume you like to expand and click the **Expand** button:

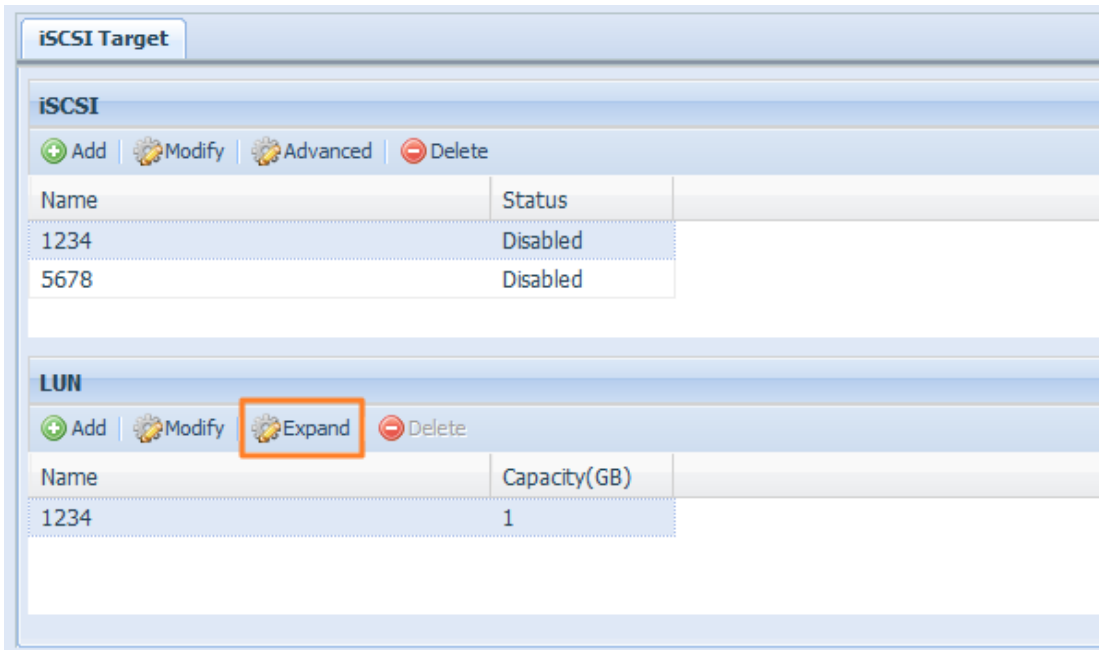

You will then see the dialog box displayed below. Drag the **Expand Capacity** bar to the size you want. Then press **Expand** to confirm the operation.

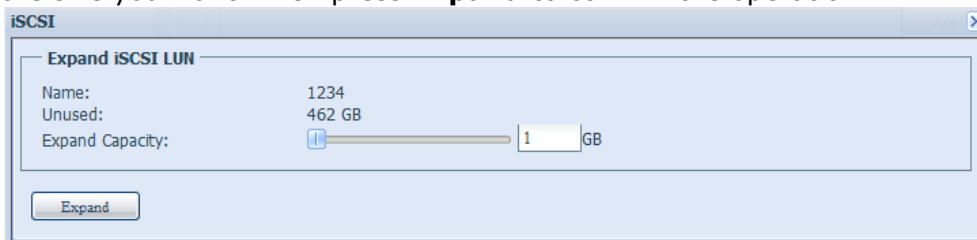

Delete Volume

To delete volume on the current RAID volume, follow the steps below:

1. Under the **Volume Allocation List**, click **Delete**.
The **Space Allocation** screen appears.

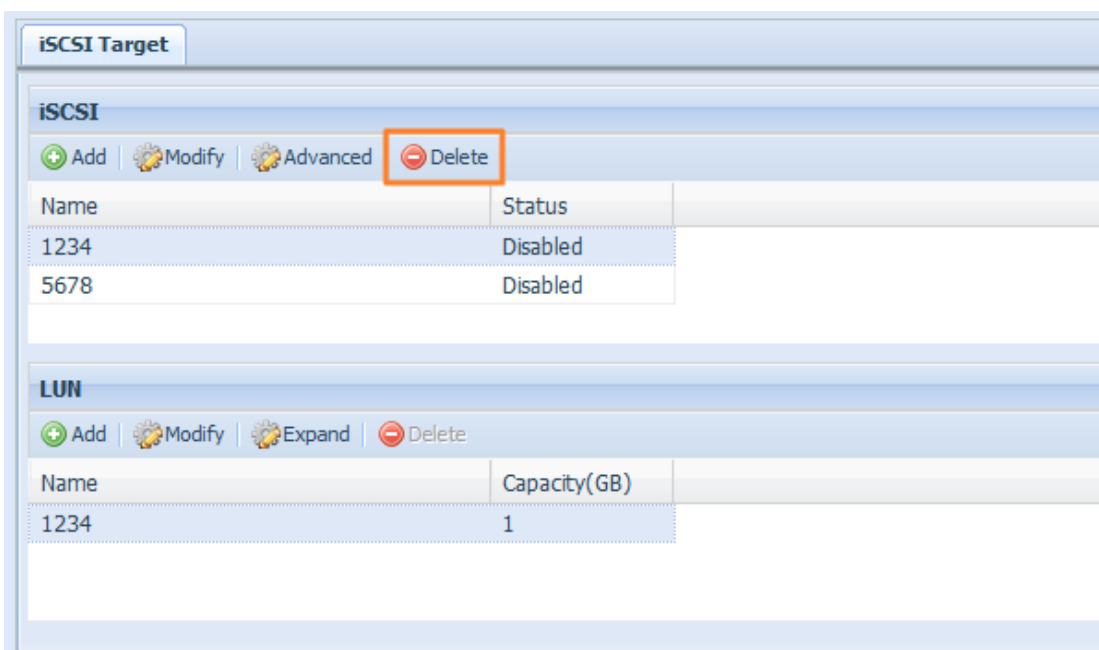

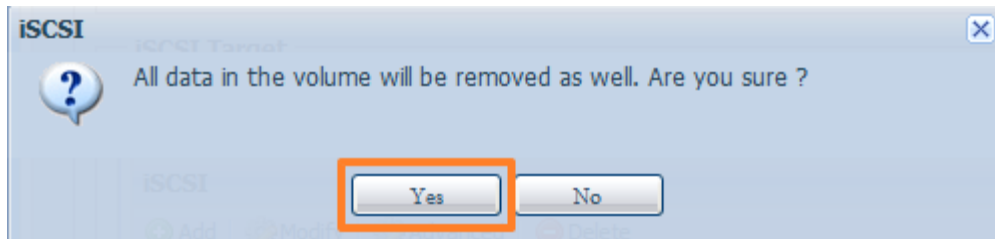

2. Press **YES**. All data in the volume will be removed.

iSCSI Thin-Provisioning

If iSCSI Thin-Provisioning is selected when creating an iSCSI target volume, virtual memory is assigned to the target, allowing the physical memory to reach maximum capacity and adding new disks only when needed.

To setup iSCSI thin-provisioning, simply select "Thin-Provision" mode from the "Create LUN" setting screen.

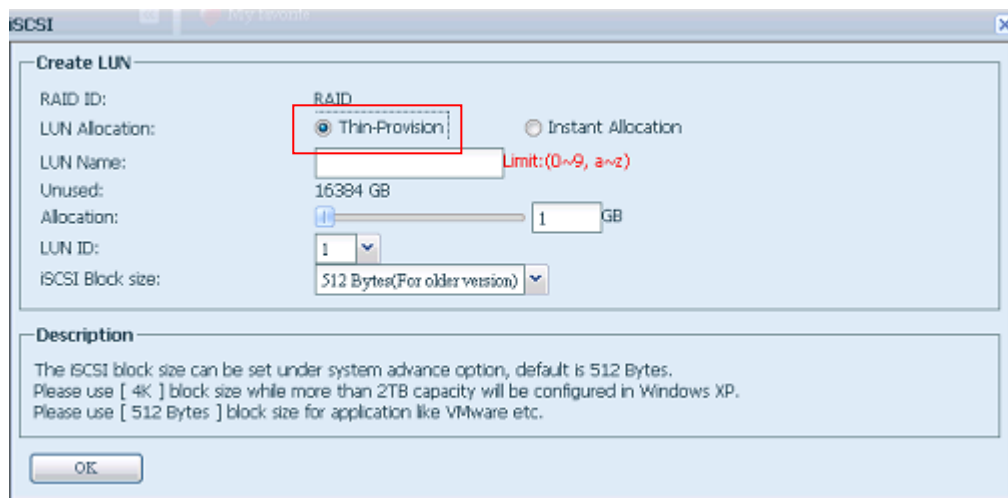

Next, allocate capacity for the iSCSI thin-provision volume by dragging the **Allocation** bar to the desired size.

After the size has been determined, click **OK** to confirm. Now you will see the iSCSI thin-provisioning volume is available from the list. Please refer to the screenshot below.

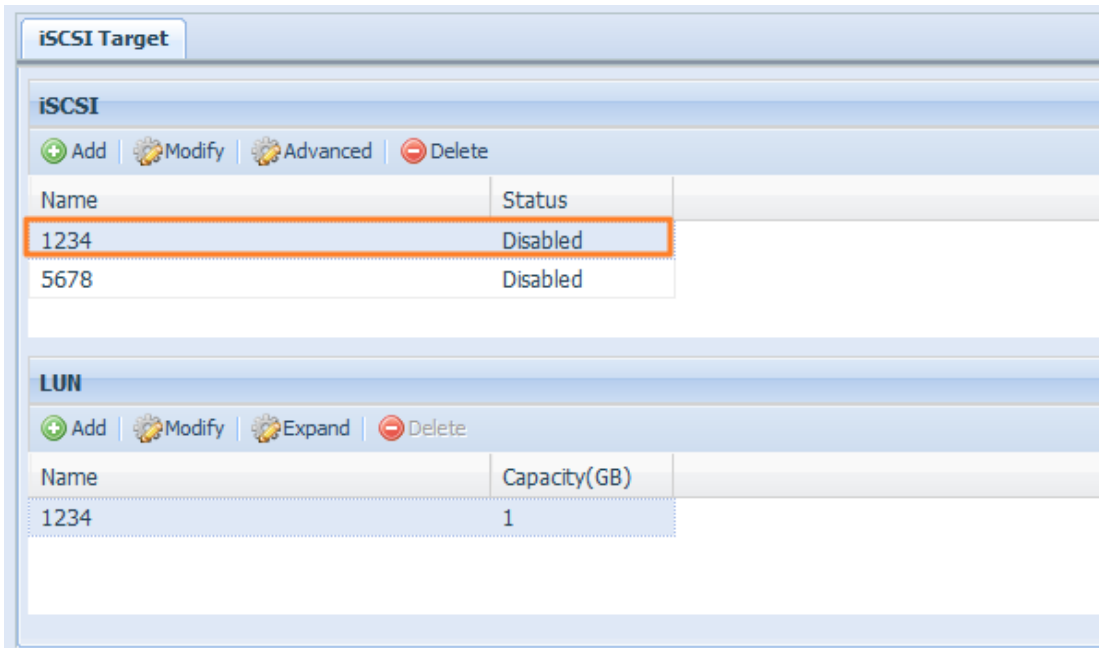

If creating an iSCSI target volume under "Instant Allocation", physical memory is assign to the target, being limited by the available memory. For the iSCSI target volume created under "thin-provisioning", virtual memory is assigned to the volume, which can go up to 16384GB (16TB).

Advance Option

There are 3 available options for the user to operate Thecus IP storage associated with iSCSI setting. The details are listed in the following screenshot. If the options are modified, the system will need to reboot for the changes to take place.

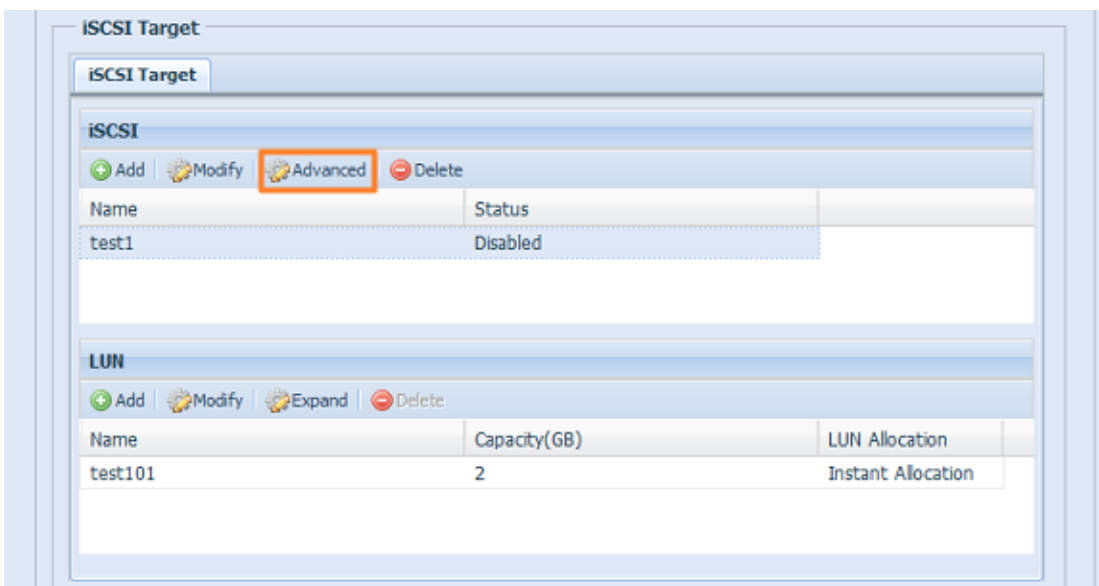

iSCSI CRC/Checksum

To enable this option, the initiator can connect with "Data digest" and "Header digest".

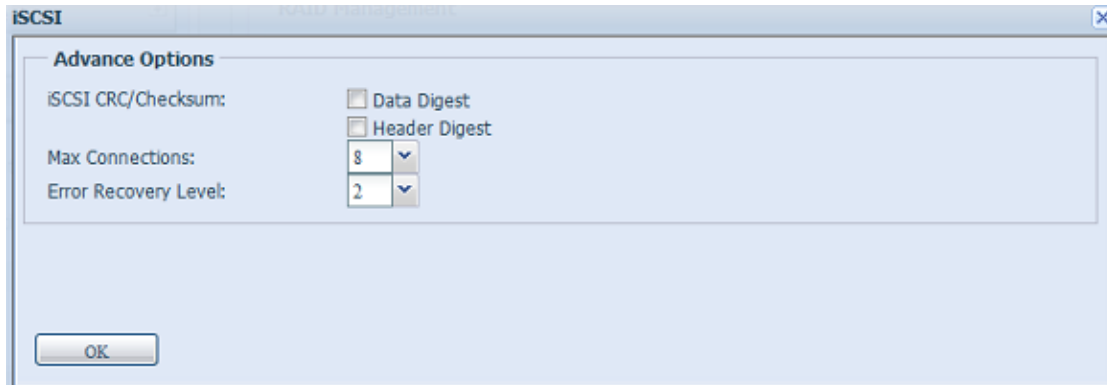

Max Connections

The maximum number of iSCSI connections.

Error Recovery Level

The Error Recovery Level (ERL) is negotiated during a leading iSCSI connection login in traditional iSCSI (RFC 3720) and iSER (RFC 5046).

ERL=0: Session Recovery

ERL=0 (Session Recovery) is triggered when failures within a command, within a connection, and/or within TCP occur. This causes all of the previous connections from the failed session to be restarted on a new session by sending a iSCSI Login Request with a zero TSIHRestart all iSCSI connections on any failure.

ERL=1: Digest Failure Recovery

ERL=1, only applies to traditional iSCSI. For iSCSI/SCTP (which has its own CRC32C) and both types of iSER (so far), handling header and data checksum recovery can be disabled.

ERL=2: Connection Recovery

ERL=2, allows for both single and multiple communication path sessions within a iSCSI Nexus (and hence the SCSI Nexus) to actively perform realligence/retry on iSCSI ITTs from failed iSCSI connections. ERL=2 allows iSCSI fabrics to take advantage of recovery in all regards of transport level fabric failures, and in a completely OS independent fashion (i.e. below the host OS storage stack).

Disk Clone and Wipe

Disks installed on this device are able to utilize the Disk Clone and Wipe function

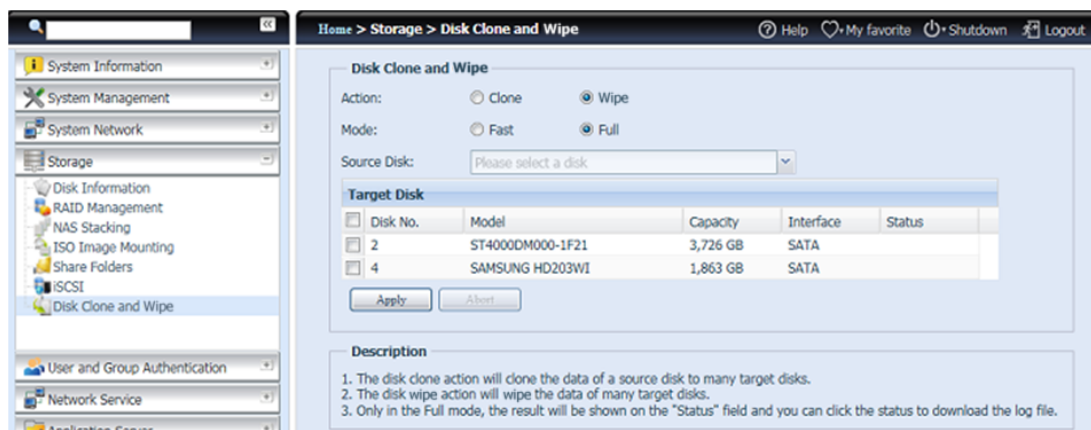

Disk Clone:

Unused Disks that have been installed on this storage device can utilize the disk clone function. If disks have already been configured in a RAID volume or as a spare disk, they cannot perform disk clone.

To start disk clone, select the source disk from the drop down menu and target a disk from the dialog box as seen below. Carry on to press "Apply," then the task will start. It may take a few hours depending on the size of the disk.

Please be sure the source disk is equal to or smaller than the target disk.

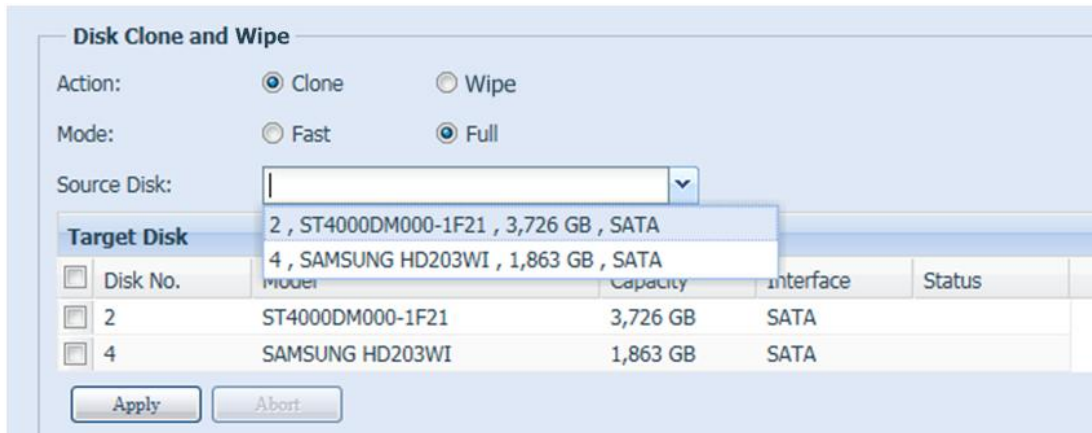

Disk Wipe:

Disk Wipe is able to erase data from selected disks. Again, disks that have already been configured in a RAID volume or as a spare disk cannot perform this function.

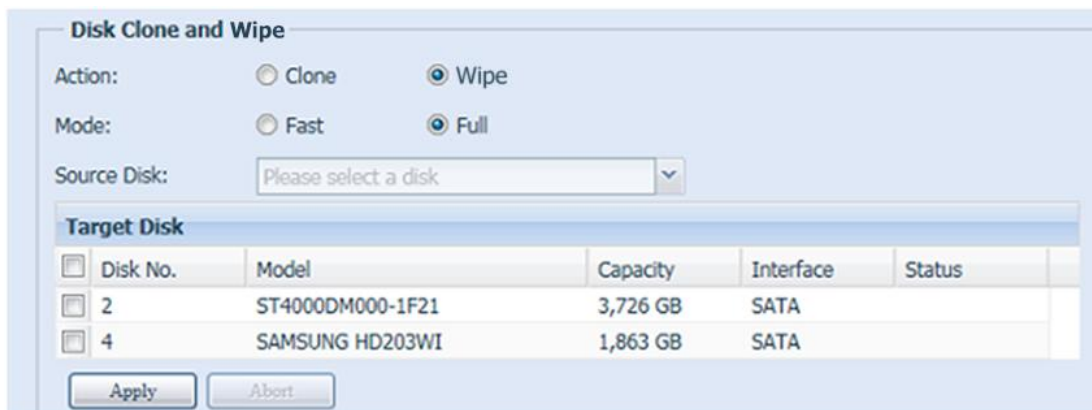

Disk Clone and Wipe	
Item	Description
Action	Click to choose to perform Disk Clone or Disk Wipe
Mode	2 options can be chosen: Fast: suitable for single disk to many tasks but less information to be displayed Full: suitable for single to single disk operation and will have a complete log recorded during operation
Source Disk	Listed available disks can used as the source disk while performing disk clone
Target Disk	Listed available disks can be used for disk clone or disk wipe
Apply	To save your settings.

High-Availability (N8900, N12000 series/N16000 series/N12850/N16850 only)

HA keeps your data active on two separate systems, Thecus Supports Active/Passive HA — provides a fully redundant instance of each node, which is only brought online when its associated primary node fails.

HA setup procedure:

HA needs two **identical** Thecus systems (same models and same hard disk slot installed) which are capable for high availability features. One needs to be setup as "Primary" and the second unit as "Secondary", both units' needs to have the RAID volume build up prior installation.

WARNING

Please be notified that if the system has been used as a standalone station before and contained more than one RAID volume with data inside, once it is used for HA, all of data will be destroyed.

Let's see an example with two Thecus Units.

1st unit: Host name: PMA (172.16.66.25) with JBOD RAID volume. This unit will be setup as the Primary server.

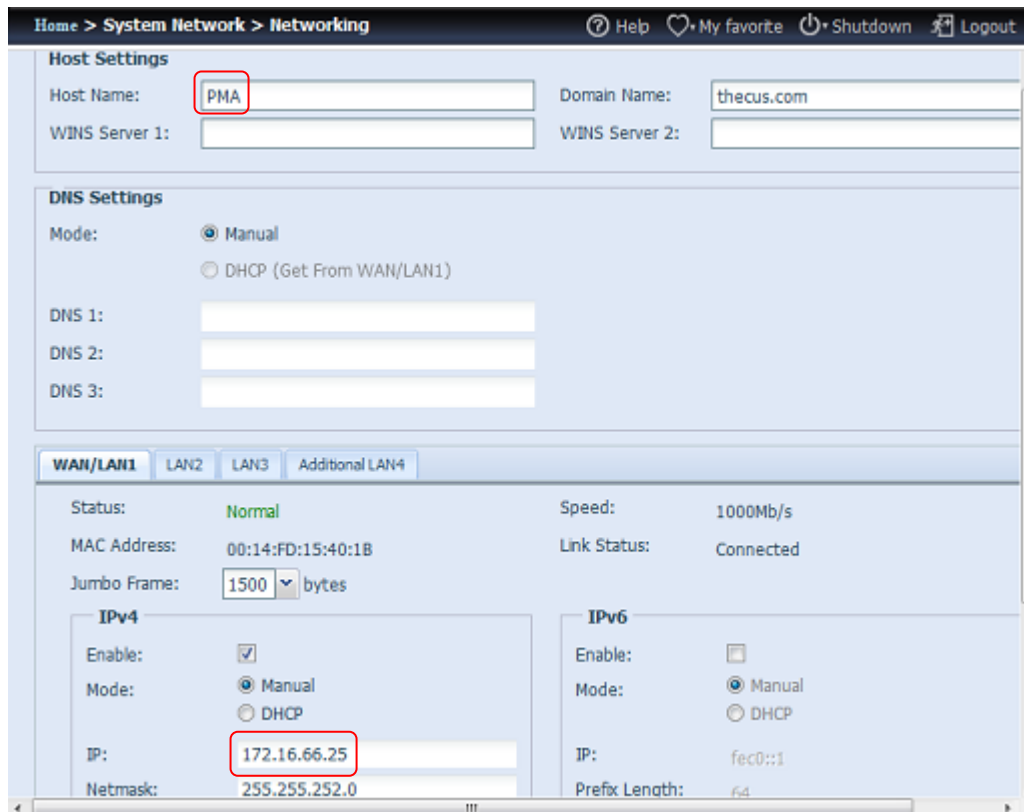

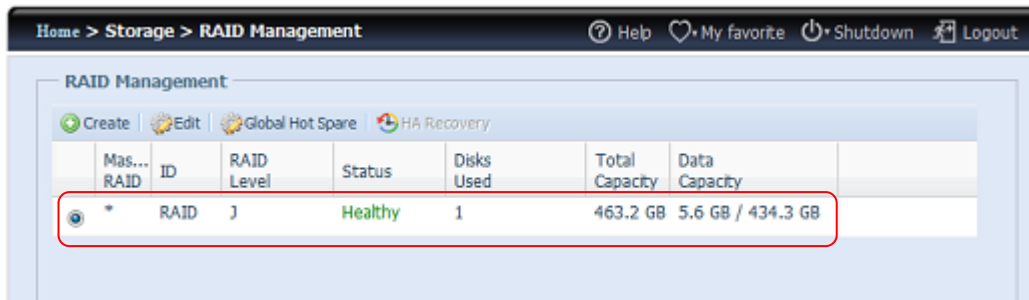

2nd unit: Host name: PMS (172.16.66.24) with JBOD RAID volume. This unit will be setup as the Secondary server.

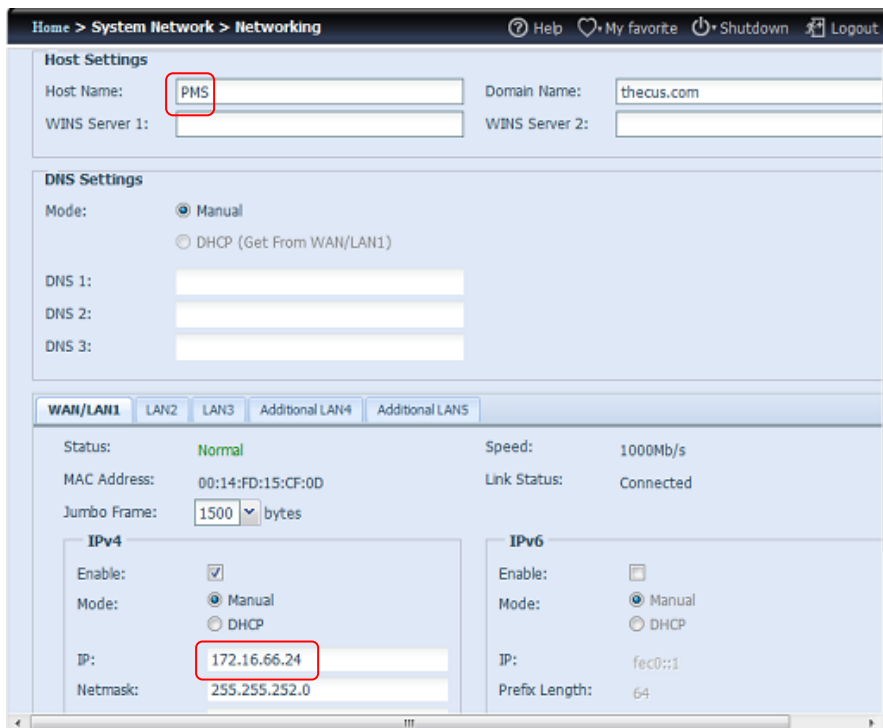

WARNING

The HDD capacity of HA Secondary server must be equal or greater than the Primary server or a warning message will appear.

Setting up the Primary unit for HA. Let's use the Primary unit from our example PMA (172.16.66.25):

- i. Login in to web UI of system 172.16.66.25. Then go to "High Availability" HA configuration page under the Storage category.

- ii. Click on "Enable" radio button, then the setting page will appear.

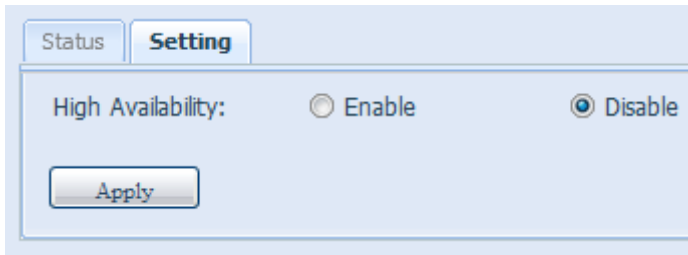

- iii. Choose the server role of the system, for this example, we will have this unit as 'Primary Server'. So "Primary Server" is checked.

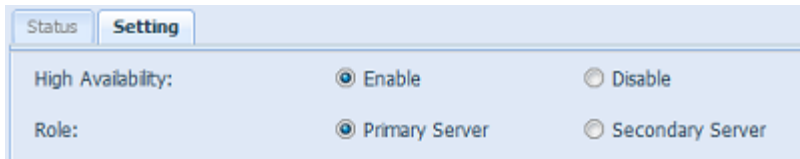

- iv. Choose the "Auto Failback" option, the default is disabled. For more details about auto failback, please refer to the description below.

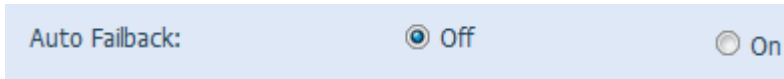

Auto Fail Back:	
Auto Fail Back:	<p>In legacy Heartbeat clusters, the auto failback option would determine whether a resource would automatically fail back to its "Active" node, or remain on whatever node is serving it until that node fails, or an administrator intervenes. The possible values for auto failback were:</p> <p>on - enable automatic failbacks off - disable automatic failback</p> <p>When auto failback is off (default): After the original active server is damaged and then returned to a healthy state, the original standby server will remain active and the original active server will go into standby mode. The servers will exchange roles.</p> <p>When auto failback is on: After the original active server is damaged and then returned to a healthy state, the original standby server will go back into standby mode and the original active server will become active again. The servers return to their original roles.</p> <p>With or without auto failback, synchronization will begin immediately without a break in service when the damaged server returns. The roles described above are assumed immediately and do not need to wait for synchronization. The virtual IP will always be mapped to the current active server.</p>

- v. Fill in the "Virtual Server" hostname information for further access need. For this example, we will use "HApm" for the virtual server hostname.

Virtual host name:

- vi. Fill in the "Secondary Server" hostname information. For this example, we will use "PMS" for the secondary server hostname. Please make sure the associated Secondary server with the "PMS" host name has been setup.

Secondary host name:

- vii. Fill in the "Virtual IP" information:
 1. Please select the network interface from the drop down list of physical connective available. It can be either on board LAN ports or additional add-in NIC, even 10G.

The screenshot shows the 'Virtual IP' configuration window. The 'Interface' dropdown menu is open, displaying the following options: WAN/LAN1, LAN2, LAN3, and Additional LAN4. The 'Indicator IP' field is currently empty.

2. Input "Indicate" IP address. This "indicate IP" is used for the system to ping out then check whether the system is still alive. So please input an IP address that is going to response properly.

Indicator IP:

3. Filled in IP information for the "Virtual IP" and "Secondary Server IP" in either IPv4 or IPv6. For our example we chose the "WAN/LAN1" for the connection interface and virtual IP 172.16.66.87. The secondary server IP address is 172.16.66.24 has mentioned earlier.

The screenshot shows the 'Virtual IP' configuration window with the following settings:

- Interface: WAN/LAN1
- Indicator IP: 172.16.66.135
- IPv4:
 - Virtual IP: 172.16.66.87
 - Primary IP: 172.16.66.25
 - Secondary IP: 172.16.66.24
- IPv6:
 - Virtual IP: (empty)
 - Primary IP: (empty)
 - Secondary IP: (empty)

Buttons at the bottom: Advance options..., Apply

- viii. Choose the network interface for heartbeat in between the systems. It can be selected from the drop down list, if there is additional LAN card that has been installed, such as 10G card, it can be used for the heartbeat role. After inserting the IP addresses for direct link needed in between the primary and secondary servers, default value will appear. Normally, no modifications will be required. The example here we will use the "Additional LAN4" which is a 10G NIC to be used for the heartbeat link between the primary and secondary servers.

Virtual IP **Heartbeat**

Interface: Additional LAN4

IPv4 Primary IP: LAN3

IPv4 Secondary IP: 192.168.5.201

Virtual IP **Heartbeat**

Interface: Additional LAN4

IPv4 Primary IP: 192.168.5.200

IPv4 Secondary IP: 192.168.5.201

- ix. Advance options can be setup by pressing the associated button.

Advance options... Apply

Advance options

Keepalive Time: 2

Deadtime: 30

Warntime: 10

Initial Deadtime: 120

UDP Port: 3694

Interface: LAN3

IPv4 Primary IP: 192.168.5.200

OK

Heart Beats Configuration	
Item	Description
Keep alive time	The keep alive directive sets the interval between heartbeat packets. It is specified according to the Heartbeat time syntax.
Dead time	The dead ping directive is used to specify how quickly Heartbeat should decide that a ping node in a cluster is dead. Setting this value too low will cause the system to falsely declare the ping node dead. Setting it too high will delay detection of communication failure. This feature has been replaced by the more flexible ping resource agent in Pacemaker, and should no longer be used.
Warning time	The warn time directive is used to specify how quickly Heartbeat should issue a "late heartbeat" warning.
Initial dead time	The initial dead parameter is used to set the time that it takes to declare a cluster node dead when Heartbeat is first started. This parameter generally needs to be set to a higher value, because experience suggests that it sometimes takes operating systems many seconds for their communication systems before they operate correctly.
UDP port	The udp port directive specifies which port Heartbeat will use

	for its UDP intra-cluster communication. The default value for this parameter is UDP 694 port.
--	--

- x. Click "Apply", the Primary server will prompt the message below and wait for the "Standby" server settings to be completed.

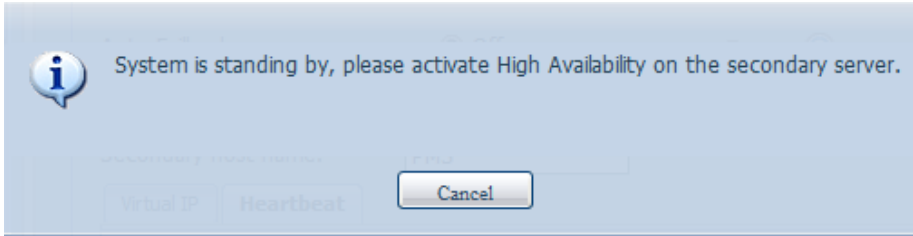

Setting up the Secondary unit for HA. The secondary unit for our example is PMS (172.16.66.24):

- xi. Login in to the web UI of the system 172.16.66.24 then go to "High Availability" HA configuration page under the Storage category.
- xii. Click on the "Enable" radio button, the setting page will appear.

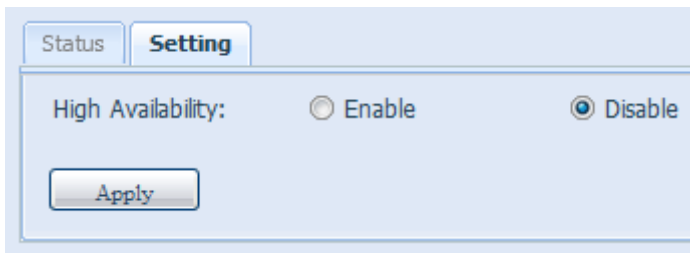

- xiii. Choose the server role of the system, for this example, we will have this unit set as the "Secondary Server". So "Secondary Server" is checked. After, please fill in the associated "Primary Server" IP address.

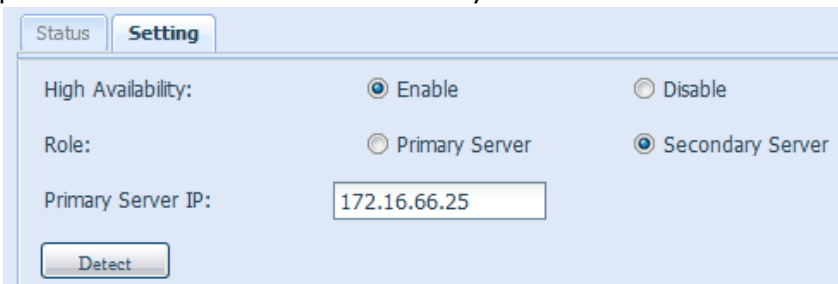

- xiv. Click "Detect" and the Secondary unit will start to check for the Primary server status. If the Primary server has replied properly, then the message will appear as below.

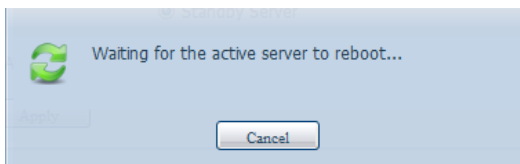

Please check the Primary Server unit. You will see an interactive message saying to reboot both "Primary" and "Secondary" server together to complete the High Availability settings.

The last state of the Primary server is: waiting for the Secondary server as shown in the screen shot below:

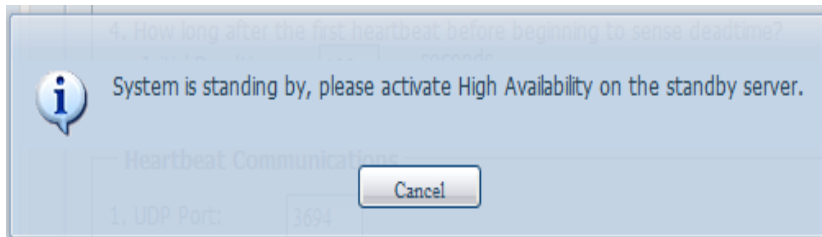

After the Secondary server has communicated with Primary Server successfully, then the state will changed to:

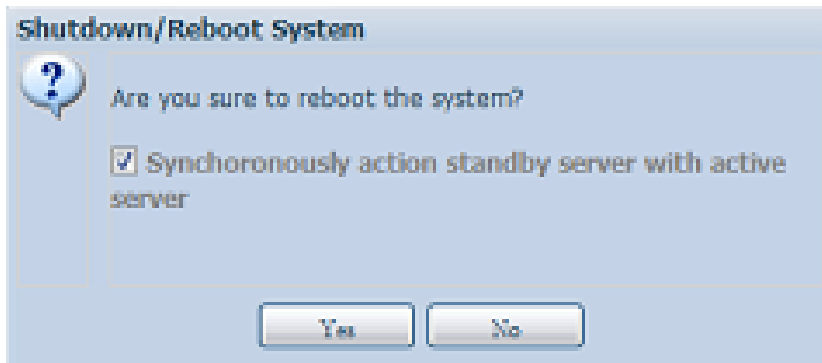

Click "Yes" to reboot both Primary and Secondary server.

If the communication has failed then you will see an error message as below.

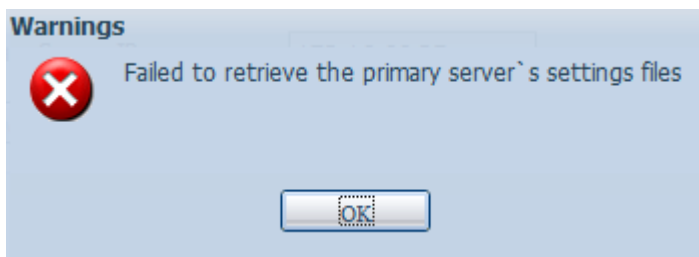

Conditions in which the secondary server will take over to play the role as Active:

1. Primary server RAID is damaged
2. Loss of the primary server's data port connection
3. Primary server goes down for any other reason

When the primary server encounters the above-mentioned situations, the secondary server (PMS) will immediately take over to play the role as active. The secondary server's system log will show "HA changed to active, getting resources", and "Healthy: The RAID [HA] on system [PMS] is healthy now."

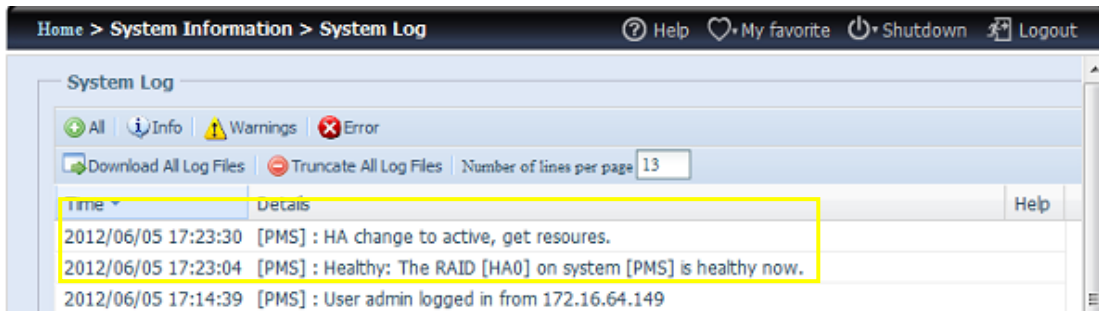

At this time, the virtual IP address will be mapped to the PMS system because it is in an active state.

HA Ready:

After both Primary and Secondary systems has rebooted, the HA link status and the HA RAID volume can be seen from the HA status page.

Please note, it will take 1~2 minutes to complete the primary and secondary servers' role played. If both servers are displayed as standby, please wait for the systems to synchronize with each other.



From the HA Primary server "PMA (172.16.66.25)" it will denote the role of "Active" and for the "PMS (172.16.66.24)", it will show the role as Standby.

The HA RAID volume status can be found as shown in the screen shot below.

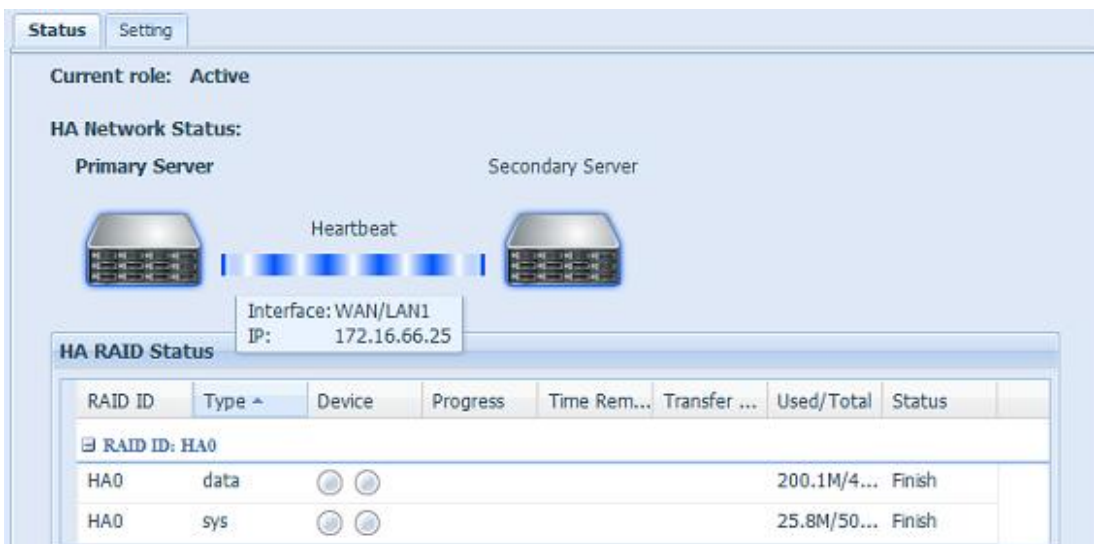

The user can access this newly create HA system by its virtual IP. Using widows, the user can simply input 172.16.64.87 or HApm in the navigation bar then the available share files will be listed as below:

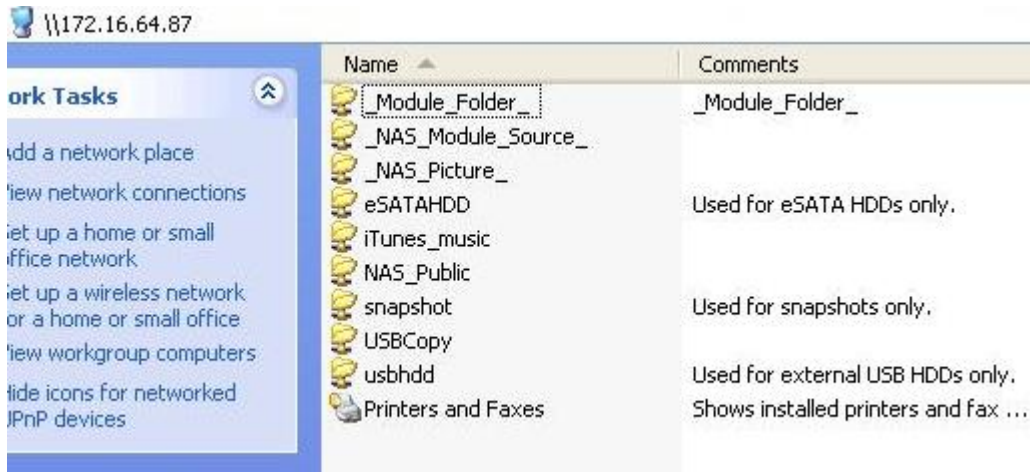

HA Recovery:

If one of the HA member is down and need to be recovered, simply go to the RAID management page and the "HA Recovery" icon will be available. Click on the "HA Recovery" icon, then the system will prompt a box to inquire about the Active server heartbeat link IP address. After inputting the IP address and pressing Apply, the unit will be recovered fully.

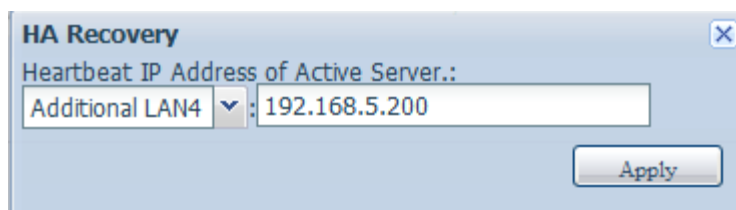

Another circumstance where HA recovery might be needed is when the HA button has been enable but the system detected a previously existing HA configuration. Then the screen will prompt the message box as shown below:

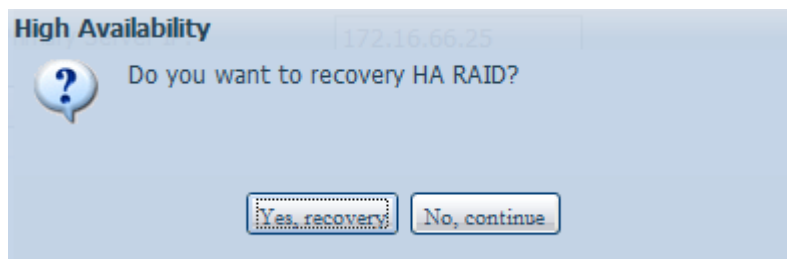

If the other HA member is running smoothly, please choose "Recovery HA" to complete HA recovery. Or select "No, continue" to let both HA members has they are.

WARNING

If there are transfers in progress when the Primary server encounters problems and the Secondary server becomes active, the session will be stopped. Please contact your network administrator to determine whether or not your transfers were completed.

WARNING

When the original primary server rejoins the HA environment, it will be updated with the newer data from the secondary server to synchronize for HA. Please be aware that the data on the original primary server will be replaced by the data from the secondary server.

User and Group Authentication

The Thcus IP storage has built-in user database that allows administrators to manage user access using different group policies. From the **User and Group Authentication** menu, you can create, modify, and delete users, and assign them to groups that you designate.

ADS/NT Support

If you have a Windows Active Directory Server (ADS) or Windows NT server to handle the domain security in your network, you can simply enable the ADS/NT support feature; the Thcus IP storage will connect with the ADS/NT server and get all the information of the domain users and groups automatically. From the **Accounts** menu, choose **Authentication** item and the **ADS/NT Support** screen appears. You can change any of these items and press **Apply** to confirm your settings.

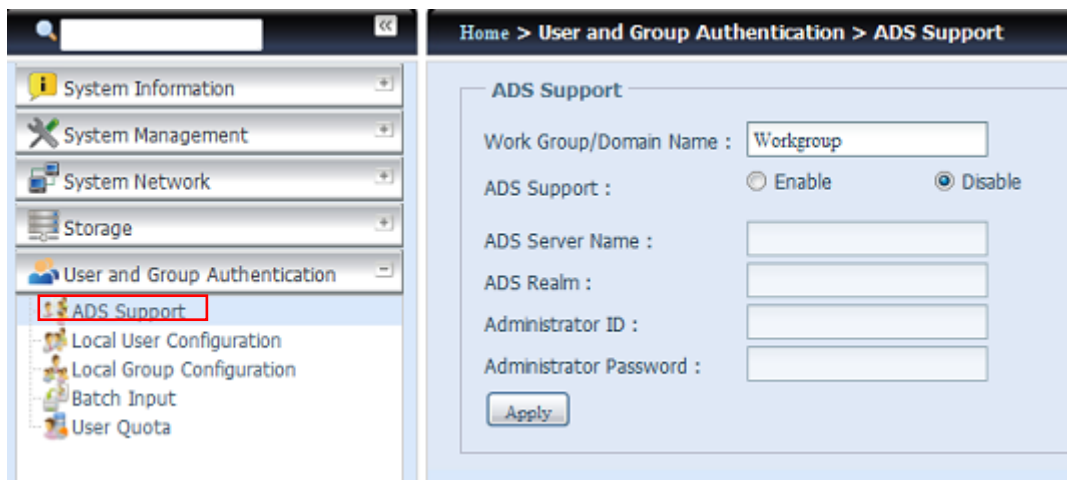

A description of each item follows:

ADS/NT Support

Item	Description
Work Group / Domain Name	Specifies the SMB/CIFS Work Group / ADS Domain Name (e.g. MYGROUP).
ADS Support	Select Disable to disable authentication through Windows Active Directory Server.
ADS Server Name	Specifies the ADS server name (e.g. adservername).
ADS Realm	Specifies the ADS realm (e.g. example.com).
Administrator ID	Enter the administrators ID of Windows Active Directory, which is required for Thecus IP storage to join domain.
Administrator Password	Enter the ADS Administrator password.
Apply	To save your settings.

To join an AD domain, you can refer to the figure here and use the example below to configure the Thecus IP storage for associated filed input:

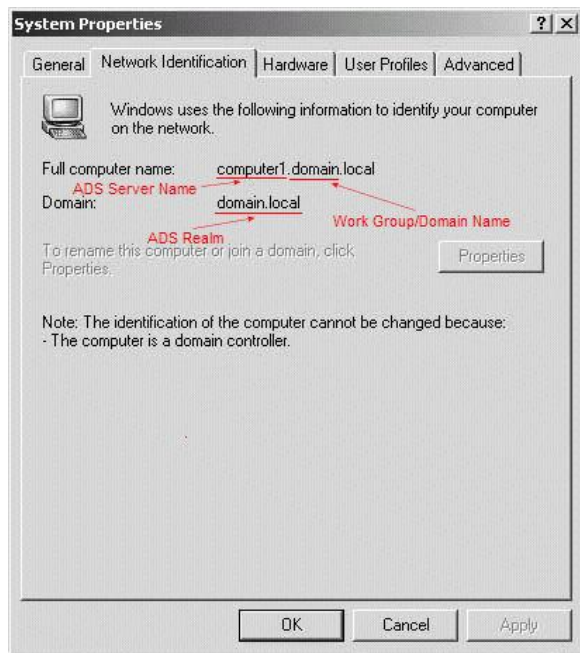

AD Domain Example	
Item	Information
Work Group / Domain Name	domain
ADS Support	Enable
ADS Server Name	Computer1
ADS Realm	Domain.local
Administrator ID	Administrator
Administrator Password	*****

NOTE

- The DNS server specified in the WAN/LAN1 configuration page should be able to correctly resolve the ADS server name.
- The time zone setting between Thecus IP storage and ADS should be identical.
- The system time difference between Thecus IP storage and ADS should be less than five minutes.
- The Administrator Password field is for the password of ADS (Active Directory Server) not Thecus IP storage.

Local User Configuration

From the **Accounts** menu, choose the **User** item, and the **Local User Configuration** screen appears. This screen allows you to **Add**, **Edit**, and **Remove** local users.

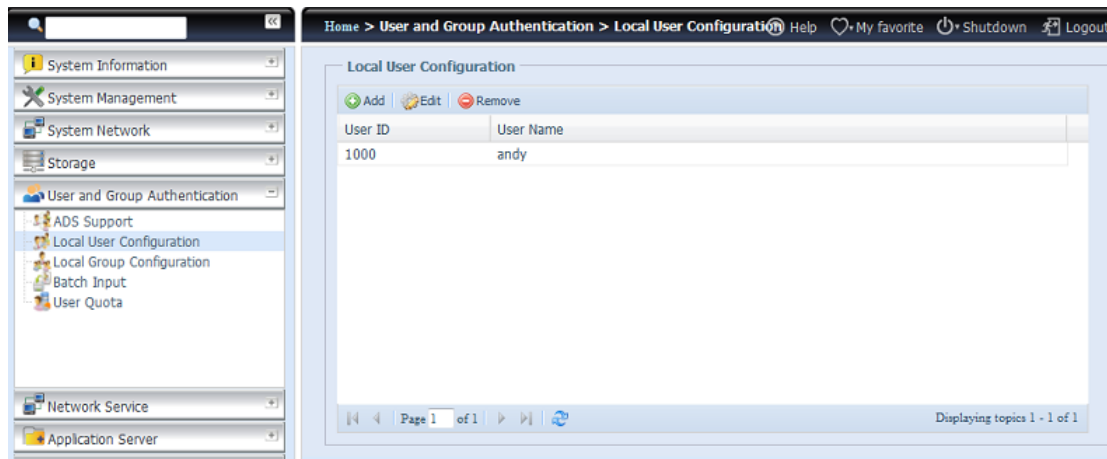

Local User Configuration	
Item	Description
Add	Press the Add button to add a user to the list of local users.
Edit	Press the Edit button to modify a local user.
Remove	Press the Remove button to delete a selected user from the system.

Add Users

1. Click on the **Add** button on **Local User Configuration** screen, and **Local User Setting** screen appears.
2. On the **Local User Setting** screen, enter a name in the **User Name** box.
3. Enter a **User ID** number or leave blank to use the system default value.
4. Enter a password in the **Password** box and re-enter the password in the **Confirm** box.
5. Select which group the user will belong to. **Group Members** is a list of groups this user belongs to. **Group List** is a list of groups this user does not belong to. Drag and drop to have this user join or leave a group.
6. Press the **Apply** button and the user is created.

Add

Local User Setting

User Name:

User ID:

Password:

Confirm Password:

Group Members

Group ID	Group Name
100	users

Group List

Search:

Group ID	Group Name
----------	------------

Apply

NOTE

All users are automatically assigned to the 'users' group.

Edit Users

1. Select an existing user from the **Local User Configuration** screen.
2. Click on the **Edit** button, and the **Local User Setting** screen appears.
3. From here, you can enter a new password and re-enter to confirm, or drag and drop list items to have this user join or leave a group. Click the **Apply** button to save your changes.

Edit

Local User Setting

User Name:

User ID:

Password:

Confirm Password:

Group Members

GroupID	Group Name
102	users

Group List

Search:

GroupID	Group Name
---------	------------

Apply

Remove Users

1. Select an existing user from the **Local User Configuration** screen.

2. Click on **Remove** button and the user is deleted from the system.

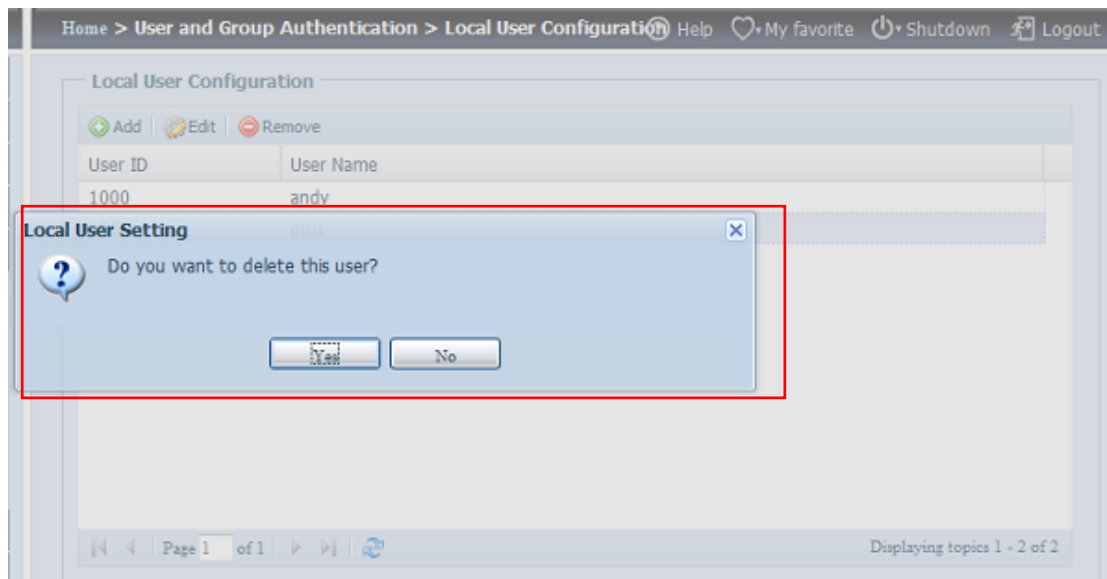

Local Group Configuration

From the **Accounts** menu, choose the **Group** item, and the **Local Group Configuration** screen appears. This screen allows you to **Add**, **Edit**, and **Remove** local groups.

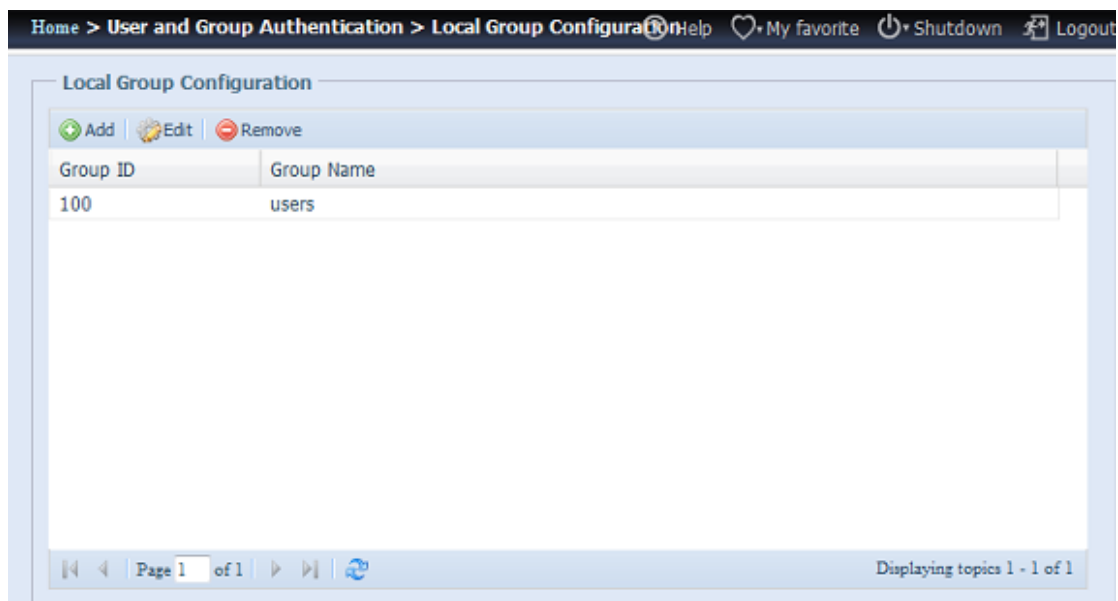

Local Group Configuration	
Item	Description
Add	Press the Add button to add a user to the list of local groups.
Edit	Press the Edit button to modify a selected group from the system.
Remove	Press the Remove button to delete a selected group from the system.

Add Groups

1. On the **Local Group Configuration** screen, click on the **Add** button.
2. The **Local Group Setting** screen appears.
3. Enter a **Group Name**.

4. Enter a **Group ID** number. If left blank, the system will automatically assign one.
5. Select users to be in this group from the **Users List** by adding them to the **Members List** using the << button.
6. Click the **Apply** button to save your changes.

The screenshot shows a dialog box titled "Add" with two main sections: "Local Group Setting" and "Users List".

Local Group Setting:

- Group Name:
- Group ID:

Members List:

UserID	User Name
--------	-----------

Users List:

Search:

UserID	User Name
1002	User

At the bottom of the dialog is an "Apply" button.

Edit Groups

1. On the **Local Group Configuration** screen, select a group name from the list.
2. Press the **Edit** button to modify the members in a group.
3. To add a user into a group, drag and drop the user from the **Users List** to move the user into the **Members List**.
4. To remove a user from a group, drag and drop the user from **Members List**.
5. Click the **Apply** button to save your changes.

The screenshot shows a dialog box titled "Edit" with two main sections: "Local Group Setting" and "Users List".

Local Group Setting:

- Group Name:
- Group ID:

Members List:

UserID	User Name
--------	-----------

Users List:

Search:

UserID	User Name
1002	User

At the bottom of the dialog is an "Apply" button.

Remove Groups

1. On the **Local Group Configuration** screen, select a group name from the list.

2. Press **Remove** to delete the group from the system.

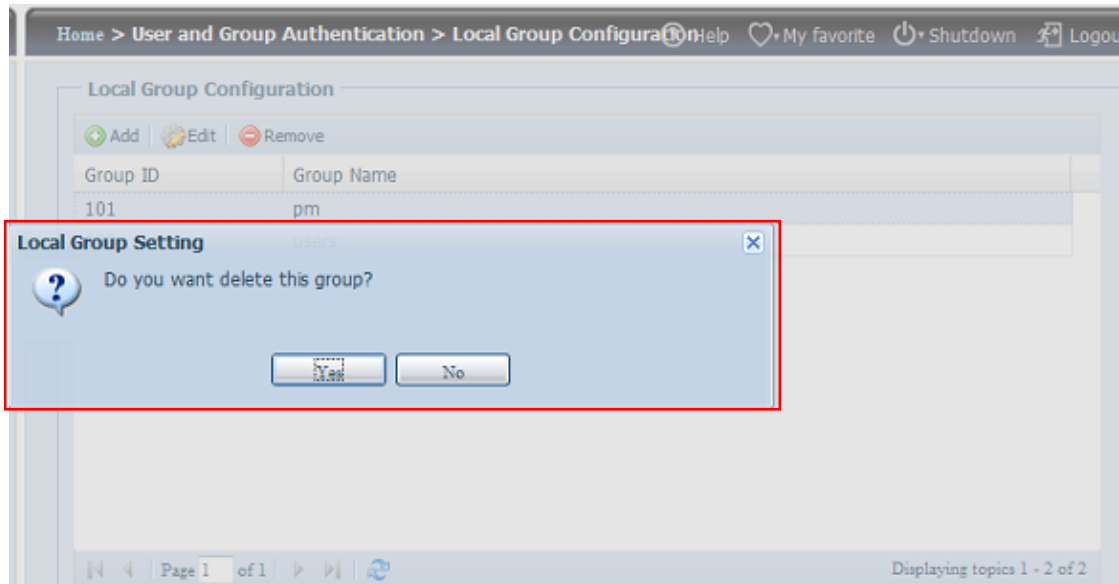

Batch Users and Groups Creation

The Thecus IP storage can also add users and groups in batch mode. This enables you to conveniently add numerous users and groups automatically by importing a simple comma-separated plain text (*.txt) file.

From the **Accounts** menu, click **Batch Input** and the **Batch User and Group Creation** dialogue will appear. To import your list of users and groups, follow these steps:

1. Click the **Browse** icon to locate your comma-separated text file.
The information in the text file should follow this format:

```
[USERNAME], [PASSWORD], [GROUP]
```

2. Click **Open**.
3. Click **Import** to begin the user list import.

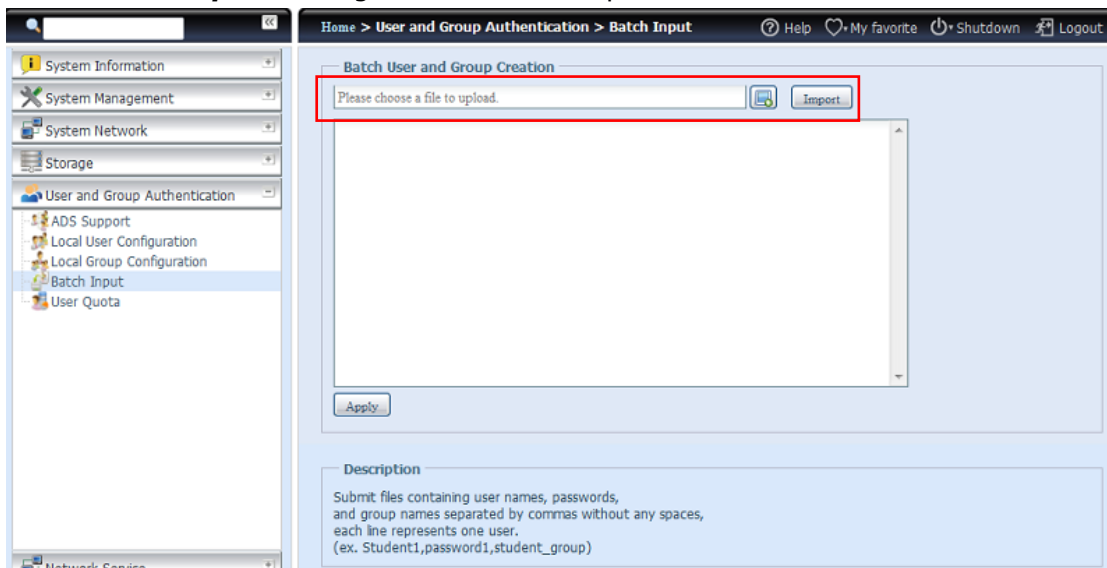

User Quota

The Thecus IP storage support local or AD users with storage quota limitations in each RAID volume of the system. To enable this function, simply click "Enable", then apply.



The screenshot shows a configuration panel titled "User Quota". Inside, there is a sub-section "Quota Support". Under "User Quota:", there are two radio buttons: "Enable" (which is unselected) and "Disable" (which is selected). To the right of these options is an "Apply" button.

Next, each user can be setup a global storage quota size for each RAID volume. Simply click on "Quota Size" for each user and input the desired capacity. After the setup is complete, please click on "Apply" to activate the user quota size.

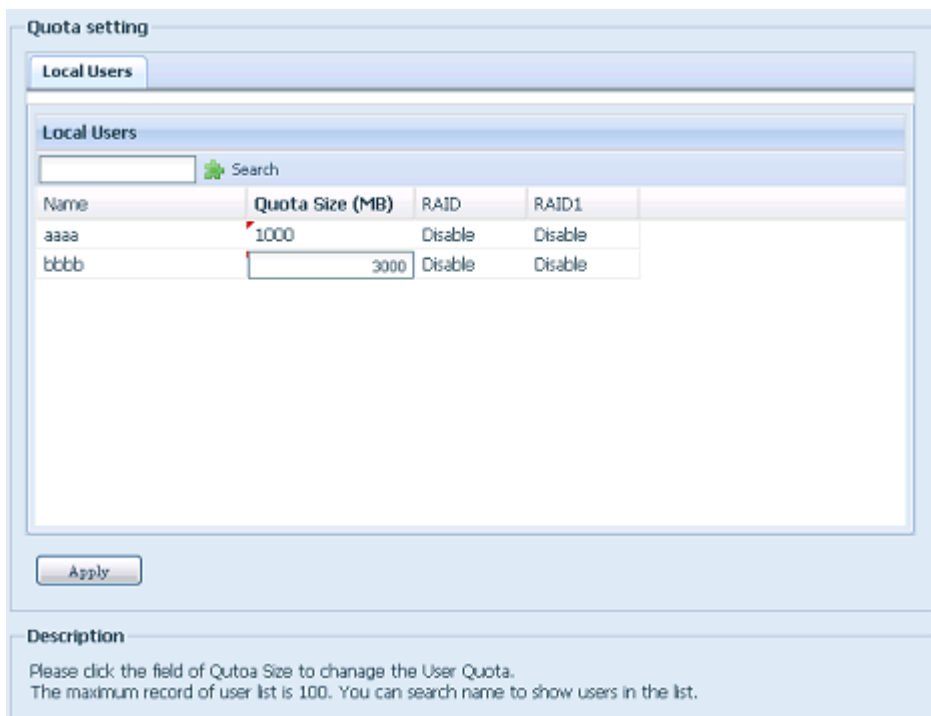

The screenshot shows the "Quota setting" interface. It has a "Local Users" tab selected. Below the tab is a search bar with a magnifying glass icon and the word "Search". A table lists local users with columns for Name, Quota Size (MB), RAID, and RAID1. The "aaaa" user has a quota size of 1000 MB, and the "bbbb" user has a quota size of 3000 MB. Both users have RAID and RAID1 set to "Disable". Below the table is an "Apply" button. At the bottom, there is a "Description" section with the following text: "Please click the field of Quota Size to change the User Quota. The maximum record of user list is 100. You can search name to show users in the list."

Name	Quota Size (MB)	RAID	RAID1
aaaa	1000	Disable	Disable
bbbb	3000	Disable	Disable

User and Group Backup

The user and group backup feature allow system users and groups to be backed up to another location and be restored if needed.

Please note, when restoring previous backup users and groups, the current users and groups list will be replaced from this restore file's contents.

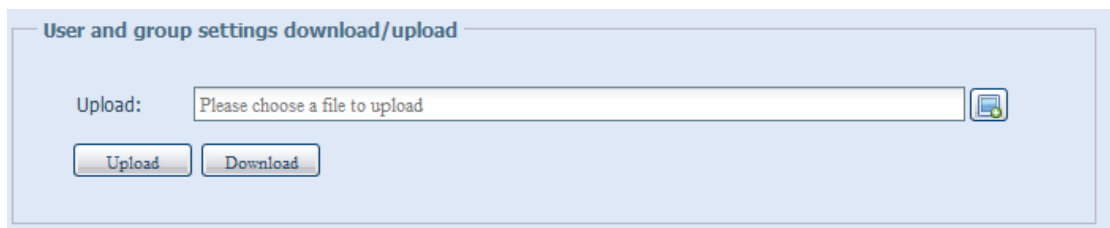

The screenshot shows a panel titled "User and group settings download/upload". It contains an "Upload:" label followed by a text input field with the placeholder text "Please choose a file to upload" and a file selection icon. Below the input field are two buttons: "Upload" and "Download".

LDAP Support

The LDAP is the other way to authenticate login users who has joined LDAP server, fill in the LDAP server information and get LDAP authentication started. Please make sure that the LDAP server has a Samba sam **and** a POSIX ObjectClass account.

The screenshot shows the 'LDAP Support' configuration page. The 'LDAP Support' section has radio buttons for 'Enable' and 'Disable', with 'Disable' selected. Below are input fields for 'LDAP Server IP', 'Base DN' (with a hint '(ex:dc=example,dc=com)'), 'Bind DN or LDAP administrator account', 'Password', 'User Base DN', and 'Group Base DN'. A dropdown menu for 'LDAP Security' is set to 'none'. The 'Current Samba ID' is displayed as 'S-1-5-21-4278180700-3855975606-1258057255'. There are 'Check objectClass' and 'Apply' buttons. A 'Description' section at the bottom lists five points regarding LDAP server requirements and security options.

A description of each item follows:

LDAP Support	
Item	Description
LDAP Support	Enable or Disable LDAP service.
LDAP Server IP	Input LDAP server IP address.
Base DN	Input base domain information ex. dc=tuned, dc=com, dc=tw
Bind DN or LDAP administrator account	Input Administrator's name.
Password	Input Administrator's password.
User Base DN	Input organization unit information where users are stored.
Group Base DN	Input organization unit information where groups are stored.
LDAP Security	Choose the LDAP security type from drop-down list.
Current Samba ID	Display the current Samba ID.
Apply	Click Apply to save your changes.
Check ObjectClass	Click this checkbox to ensure LDAP server has a Samba sam and a POSIX account or it may not work properly for LDAP client authentication.

Network Service

Use the **Network** Service menu to make network service support settings.

Samba / CIFS

There are options allow Admin to Enable/Disable to operate Thecus IP storage associated with Samba / CIFS protocol. With the option changed, it will need to reboot system to activate.

Samba/CIFS			
Samba Service:	<input checked="" type="radio"/> Enable	<input type="radio"/> Disable	
File Access Cache:	<input checked="" type="radio"/> Enable	<input type="radio"/> Disable	
Samba Anonymous Login Authentication:	<input type="radio"/> Enable	<input checked="" type="radio"/> Disable	
Samba Native Mode:	<input type="radio"/> Yes (Native Mode)	<input checked="" type="radio"/> No (Compatible Mode)	
Allow Trusted Domains:	<input type="radio"/> Yes	<input checked="" type="radio"/> No	
Block Size:	<input checked="" type="radio"/> 4096	<input type="radio"/> 1024	
Server Signing:	<input type="radio"/> Auto	<input type="radio"/> Mandatory	<input checked="" type="radio"/> Disable
Support Policy for LDAP:	<input type="radio"/> Sign	<input type="radio"/> Seal	<input checked="" type="radio"/> Plain
NT ACL Support:	<input type="radio"/> Enable	<input checked="" type="radio"/> Disable	
Allocated buffering size:	<input checked="" type="radio"/> Enable	<input type="radio"/> Disable	

Samba Service

Used for letting the operating system of UNIX series and SMB/CIFS of Microsoft Windows operating system (Server Message Block / Common Internet File System). Do the link in network protocol. Enable or Disable SMB/CIFS protocol for Windows, Apple, Unix drive mapping.

NOTE

- In some environments, due to security concerns, you may wish to disable SMB/CIFS as a precaution against computer viruses.

File Access Cache

File Access Cache is default **Enable**. This option will help to increase the performance while single client access share folder in writing under SMB/CIFS protocol.

Samba Anonymous Login Authentication

To enable this option, no matter there is share folder has been created in public access. The user account and password is needed from system to access under SMB/CIFS protocol. On the other hand, no more anonymous login is allowed.

Samba Native mode

The Thecus IP storage is supported Samba mode options. In the ADS environment with "Native" mode selected then Thecus IP storage is capable to become local master position.

Optimize Block Size

This function controls the behavior of Samba when reporting available disk space. This function was added to allow advanced administrators to increase block size to increase write performance without re-compiling the code.

Server Signing

This is setting while Samba server has been used in US of FDCC. If the system has used only in Windows environment choose "Mandatory" otherwise "Auto".

Samba/CIFS Options for Mac OS X

UNIX Extensions: Enable Disable

UNIX Extension

The default is enable for Samba usage, with situation using Mac OSX with smb connection may have permission issue. When it happened, please setup "UNIX Extension" disable to get issue solved.

Samba/CIFS Options for Recycle Bin

Samba Recycle Bin: Enable Disable

Recycle bin contents are deleted after: days (Set as 0 for manual deletion only)

Recycle Bin Folder Display: Enable Disable

Recycle Bin Max File Size: GB (Set as 0 for unrestricted)

Samba Recycle Bin

The Thecus IP storage is supported recycle bin via SMB/CIFS protocol.

Simply enable the "Recycle Bin" function and "Recycle Folder Display" then all of deleted files/folders will reside in the "_NAS_Recycle_(Associated RDID Volume)" share folder.

Samba/CIFS Options for Recycle Bin

Samba Recycle Bin: Enable Disable

Recycle bin contents are deleted after: days (Set as 0 for manual deletion only)

Recycle Bin Folder Display: Enable Disable

Recycle Bin Max File Size: GB (Set as 0 for unrestricted)

For example, the system has created 2 RAID volumes with ID "RAIDpm" and "RAID". Then it will have 2 recycle bin folder appear as "_NAS_Recycle_RAID" and "_NAS_Recycle_RAIDpm".

	Mas... RAID	ID	RAID Level	File System	Status
<input checked="" type="radio"/>		RAIDpm	J	EXT4	Healthy
<input type="radio"/>	*	RAID	J	XFS	Healthy

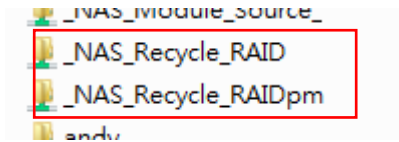

There are 2 more setting could help to manage the recycle bin for deleted folders/files.

1. Setup the "Day" to remove deleted folders/files which has resided in recycle bin permanently. Left default value "0" if desired to clean up recycle bin manually.
2. Setup the "Size" for recycle bin to allow deleted folders/files can store. Left default value "0" with no limitation.

NOTE

- The deleted files/folders which have resided in recycle bin will keep its permission. On the other hand, only the admin and owner can view/read/write these folders/files.
- If deleted single file size is large than 2GB then it won't reside in the recycle bin but erase permanently.

AFP (Apple Network Setup)

From the **Network Service** menu, choose the **AFP** item, and the **AFP Support** screen appears. This screen displays the configuration items for the Apple Filing Protocol. You can change any of these items and press **Apply** to confirm your settings.

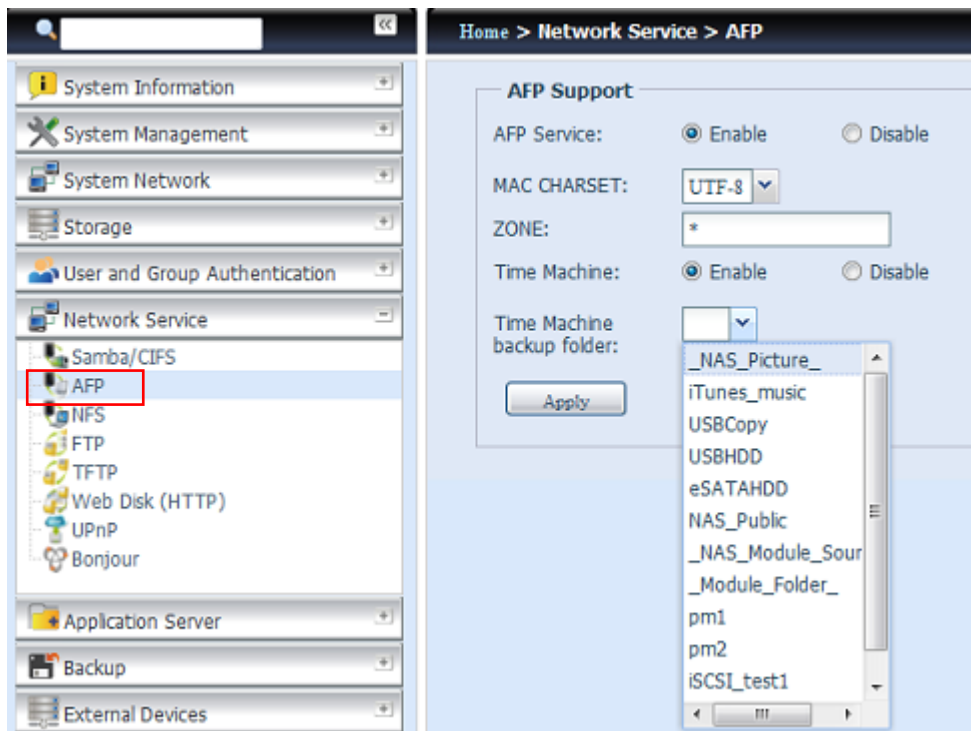

A description of each item follows:

Apple Network Configuration	
Item	Description
AFP Server	Enable or disable Apple File Service to use the Thecus IP storage with MAC OS-based systems.
MAC CHARSET	Specifies the code page from the drop down list.

Zone	Specifies Zone for Appletalk service. If your AppleTalk network uses extended networks and is assigned with multiple zones, assign a zone name to the Thecus IP storage. If you do not want to assign a network zone, enter an asterisk (*) to use the default setting.
Time Machine	Click the enable checked box if you would like your MAC system to use the Thecus IP storage as MAC time machine backup.
Time Machine backup folder	Select from the drop down list to designate the folder for time machine backup destination.

NFS Setup

From the **Network Service** menu, choose the **NFS** item, and the **NFS Support** screen appears. The Thecus IP storage can act as an NFS server, enabling users to download and upload files with their favorite NFS clients. Press **Apply** to confirm your settings.

NFS Support

NFS: Enable Disable

NFS Threads: Auto

Advanced: Add the Anonymous NFS User(nfsnobody:65534)

Apply

Description

The `_NAS_NFS_Exports_` is a system folder which cannot be accessed. Please refer to the following examples of how to mount a network device.

```
NFS3: mount -t nfs 192.168.2.254:/raid0/data/_NAS_NFS_Exports_/SAMPLE /mnt/sample
NFS4: mount -t nfs4 192.168.2.254:/SAMPLE /mnt/sample
```

A description of each item follows:

NFS Server Setting	
Item	Description
NFS	Enable or Disable NFS support.
NFS Threads	Choose the number of NFS threads.
Advanced	Checked to add the Anonymous NFS User.
Apply	Click Apply to save your changes.

FTP

The Thecus IP storage can act as an FTP server, enabling users to download and upload files with their favorite FTP programs. From the **Network Service** menu, choose the **FTP** item, and the **FTP** screen appears. You can change any of these items and press **Apply** to confirm your settings.

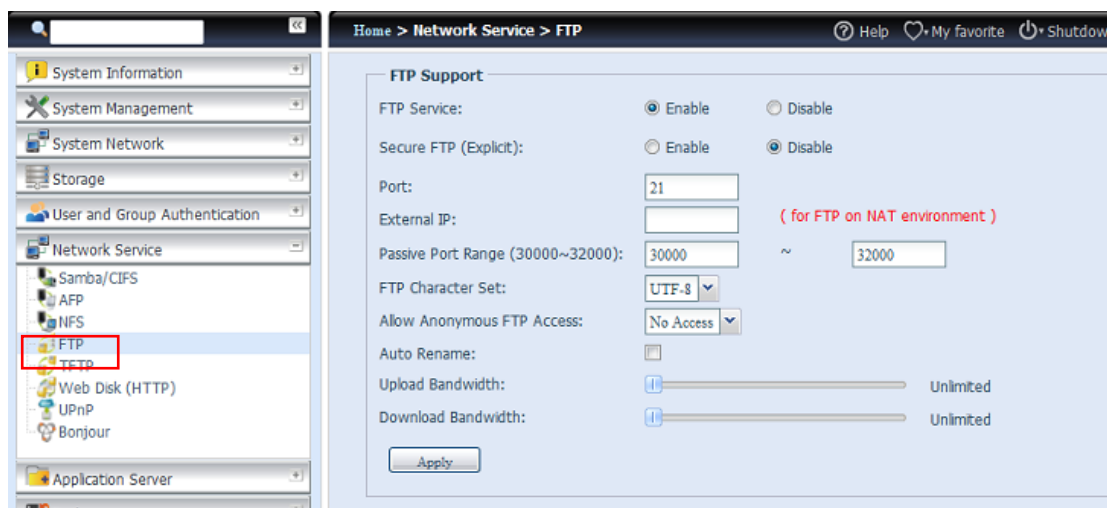

A description of each item follows:

FTP	
Item	Description
FTP	Enables FTP Service on the Thecus IP storage.
Security FTP	Enable or disable Security FTP, be sure the client FTP software has also security FTP setting enabled.
Port	Specifies the port number of an incoming connection on a non-standard port.
External IP	Input the public IP address of the router when the Thecus secure FTP server has been enabled. This can help to respond to the ftp client with proper communication information.
Passive Port Range (30000-32000)	Limited port range for the FTP server to use.
FTP ENCODE	If your FTP client or operating system does not support Unicode (e.g. Windows® 95/98/ME or MAC OS9/8), select the same encoding as your OS here in order to properly view the files and directories on the server. Available options are BIG5, HZ, GB2312, GB18030, ISO, EUC-JP, SHIFT-JIS and UTF-8.
Allow Anonymous FTP Access	Upload/Download: Allow anonymous FTP users to upload or download files to/from public folders. Download: Allow anonymous FTP users to download files from public folders. No access: Block anonymous FTP user access.
Auto Rename	If checked, the system will automatically rename files that are uploaded with a duplicate file name. The renaming scheme is [filename].#, where # represents an integer.
Upload Bandwidth	You may set the maximum bandwidth allocated for file uploads. Selections include Unlimited, 1 ~ 32 MB/s.
Download Bandwidth	You may set the maximum bandwidth allocated for file downloads. Selections include Unlimited, 1 ~ 32 MB/s.

To access the share folder on the Thecus IP storage, use the appropriate user login and password set up on the **Users** page. Access control to each share folder is set up on the **ACL** page (**Storage Management > Share Folder > ACL**).

TFTP

Thecus IP storage can act as a TFTP server, enabling users to download and upload files with their favorite TFTP programs. From the **Network Service** menu, choose the **TFTP** item, and the **TFTP** screen appears. You can change any of these items and press **Apply** to confirm your settings.

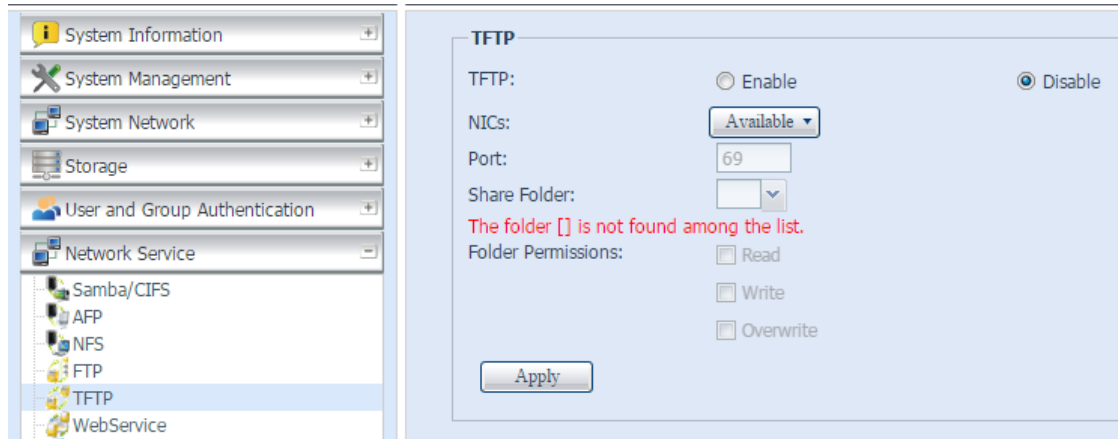

A description of each item follows:

TFTP	
Item	Description
TFTP	Enables TFTP Service on the Thecus IP storage.
NICs	Choose NICs to enable port use
Port	Specifies the port number of an incoming connection on a non-standard port.
Share Folder	Select the file stored folder, it cannot be empty.
Folder Permission	Select the folder permission

WebService

From the **Network Service** menu, choose the **WebService** item, and the **WebService Support** screen appears. This screen displays the service support parameters of the system. You can change any of these items and press **Apply** to confirm your settings.

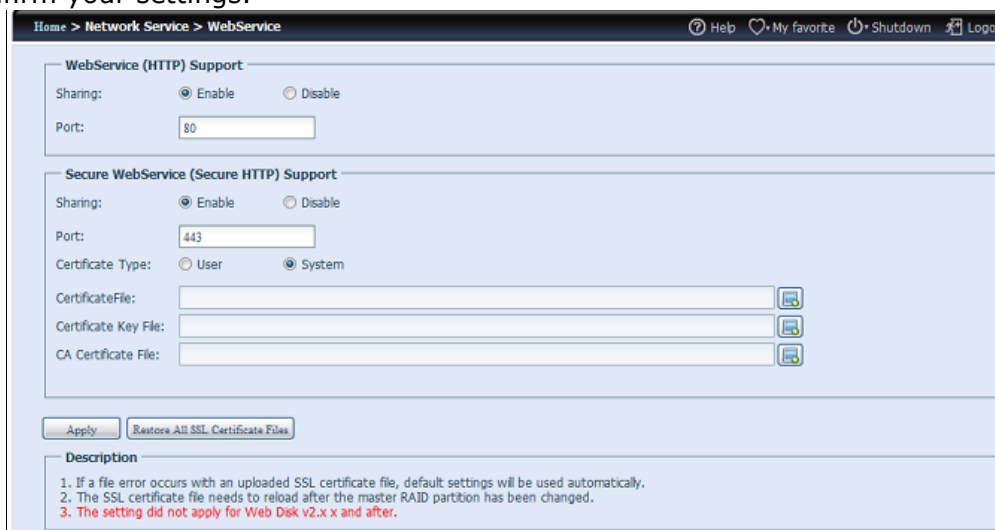

A description of each item follows:

Web Service	
Item	Description
WebService (HTTP) Support	Enable or disable WebDisk support. Enter the port number if this option is enabled. The port number is default 80.
Secure WebService (Secure HTTP) Support	Enable or disable secure WebDisk support. Enter the port if this option is enabled.
Certificate File	Upload Certificate File if choose Certificate type "User".
Certificate Key File	Upload Certificate Key File if choose Certificate type "User".
CA Certificate File	Upload CA Certificate File if choose Certificate type "User".
Restore All SSL Certificate Files	Click to set back to default certification details.
Apply	Click "Apply" to confirm the changes.

NOTE

- Disable HTTP support and Enable Secure HTTP support to guarantee secure access.

UPnP

This device supports UPnP Media server, which allows users to play media files with UPnP client (ex. DMA devices). Enable or disable Universal Plug and Play protocol. UPnP helps to find the IP address of Thecus IP storage.

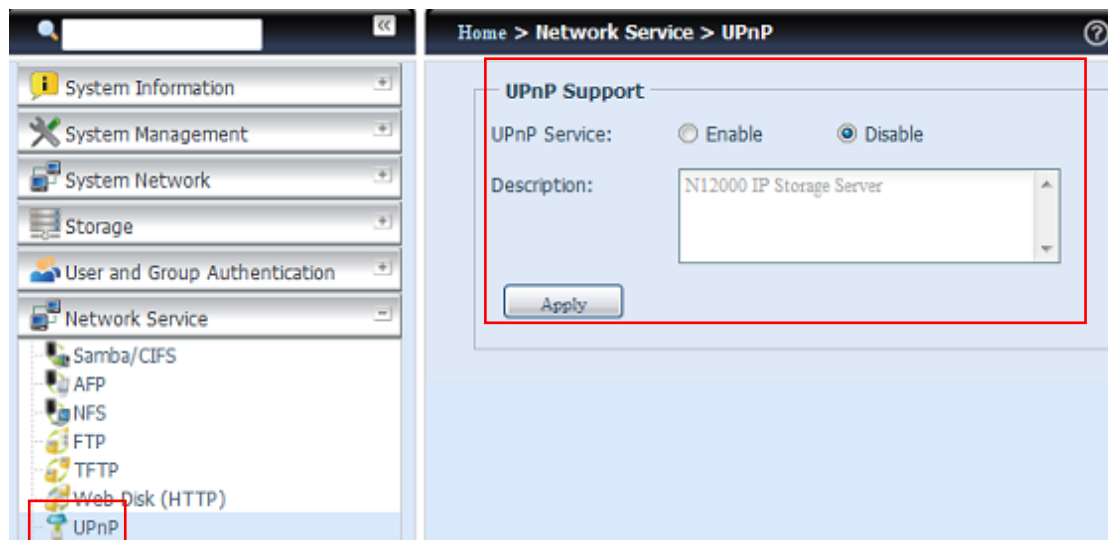

Bonjour Setting

Bonjour, is Apple Inc.'s trade name for its implementation of Zeroconf, a service discovery protocol. Bonjour locates devices such as printers, as well as other computers, and the services that those devices offer on a local network using multicast Domain Name System service records. This definitive guide walks you through Bonjour zero-configuration networking with a complete description of the protocols and technologies used to create Bonjour enabled applications and devices.

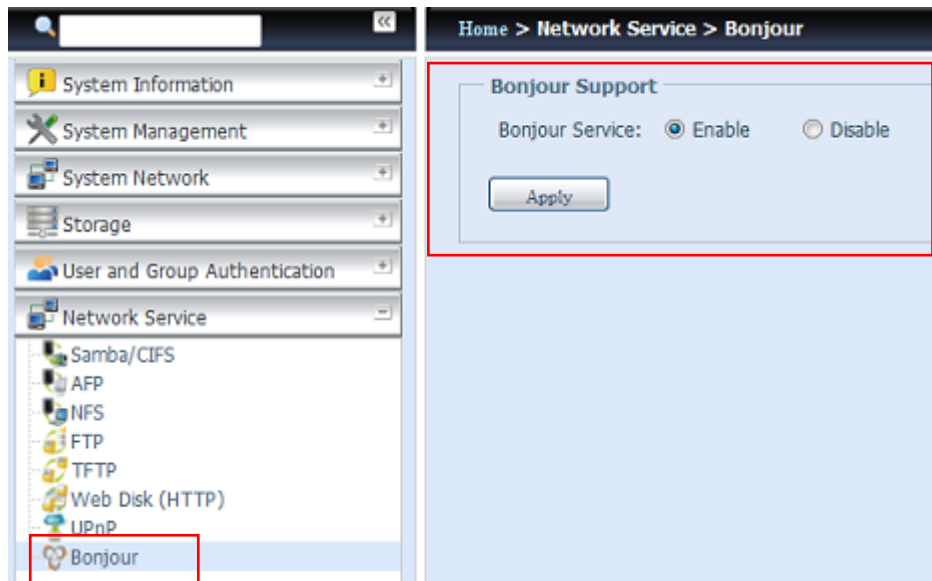

SSH

The device is now SSH protocol supported. It allows user to use SSH and have console to manipulate as needed. The SSH default login user name is "root" with full privilege and password is admin's password. The default admin password is "admin" so once the admin password has changed then SSH login need to change the password too.

A description for each item as following:

SSH	
Item	Description
SSH Service	Enable or disable SSH service.
Port	The port number is default 22.
SFTP	Enable or disable SFTP protocol under SSH service.
Apply	Click "Apply" to confirm the changes.



DDNS

To set up a server on the Internet and enable the users to connect to it easily, a fixed and easy-to remember host name is often required. However, if the ISP provides only dynamic IP address, the IP address of the server will change from time to time and is difficult to recall. You can enable the DDNS service to solve the problem.

After enabling the DDNS service of the NAS, whenever the NAS restarts or the IP address is changed, the NAS will notify the DDNS provider immediately to record the new IP address. When the user tries to connect to the NAS by the host name, the DDNS will transfer the recorded IP address to the user.

The NAS supports the DDNS providers:

DyDNS.org(Dynamic DNS),DyDNS.org(Custom DNS),DyDNS.org(Static DNS),
www.zoneedit.com,www.no-ip.com.

A description for each item as following:

DDNS	
Item	Description
DDNS Service	Enable or disable DDNS service.
Register	Choose the service provider from the drop down list
User name	Input user name with DDNS registry.
Password	Input password with DDNS registry.
Domain name	Input domain name with DDNS registry.
Apply	Click "Apply" to confirm the changes.



UPnP Port Management

One of the most convenient way to allow users to access required services such as FTP, SSH, web disk and http etc. from Internet environment is setting UPnP port management.

To set up this UPnP port forwarding feature, please be sure that the router has "UPnP Service" Enabled. The following is an example from one of the router manufacture with UPnP Configuration page.

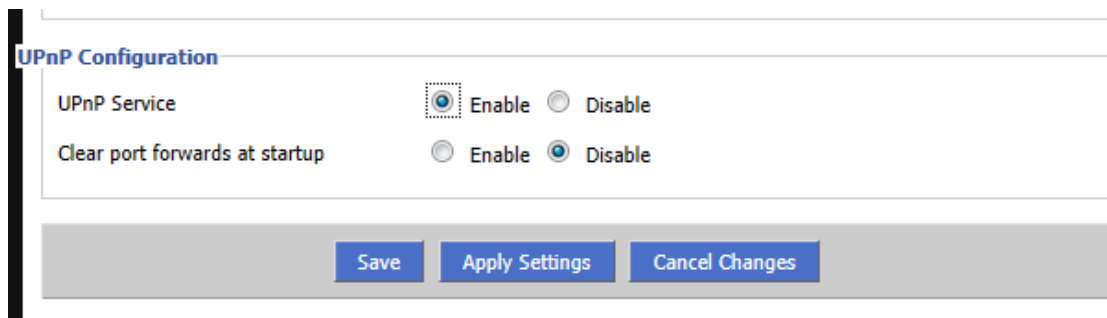

After the router has enabled "UPnP Service" then you will have information come from associated router to UPnP port management as shown in the screen shot below.

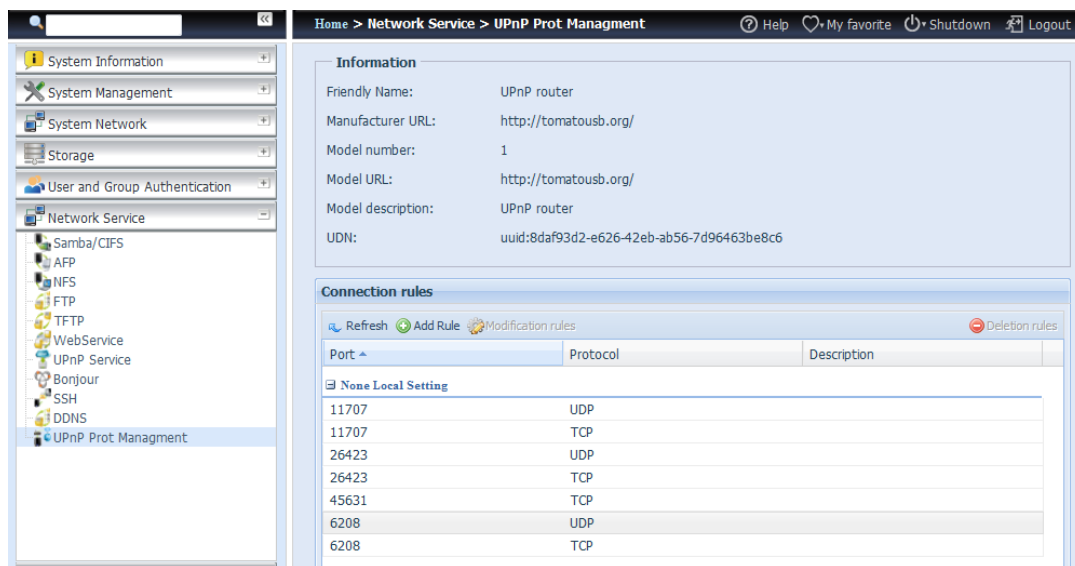

And click "Add Rule" to add more port mapping from Internet to access desired services or press "Refresh" to get most updated list.

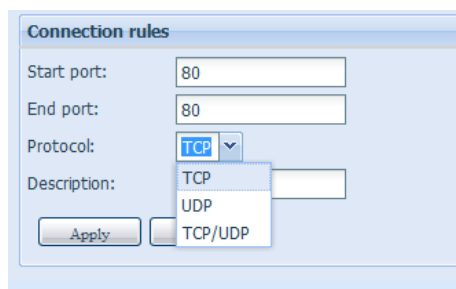

A description for each item as following:

UPnP Port Management	
Item	Description
Start port	Specific port number starts with.
End port	Specific port number ended
Protocol	Choose the protocol for port forwarding needed.
Description	Specific the port services if applicable.
Apply	Click "Apply" to confirm the changes.
Cancel	Click "Cancel" to abort the changes

WARNING

Some of the routers do not allow the input of port number below 1024. So it may have resulted "setting fails".

WebDAV

The WebDAV is an extended protocol of http(s) which allows remote access to your NAS system.

To begin using WebDAV and WebDAV SSL, simply click enable and provide the port number. The default port number is 9800, under normal circumstances this will not need to be changed.

WebDAV Support

WebDAV: Enable Disable
 Port:

WebDAV SSL: Enable Disable
 Port:

Browser View: Enable Disable

Description

- Port number must be > 1024 and < 65536
- Please set WebDAV ACL at [Share Folder] function
- [Browser View] provide valid user view files on browsers

WebDAV Configuration	
Item	Description
WebDAV Service	Press the Enable button to activate WebDAV service and specify the port number if it needs to change from the default value. P.S. Port number is limited to greater than 1024 and less than 65536
WebDAV SSL Service	Press the Enable button to activate WebDAV SSL service and specify the port number if it needs to be changed from the default value. P.S. The port number is limited to greater than 1024 and less than 65536
Browser View	Press the Enable button and viewing the share folder list through the browser will be allowed
Apply	Click "Apply" to confirm the changes.

Auto-Thumbnail

The auto thumbnail is a function on the GUI that can be used with the Thecus T-OnTheGo mobile application. It helps to resize a photo while when it is on written the NAS system. Enable this service allows you to speed up photo viewing on your Mobile device.

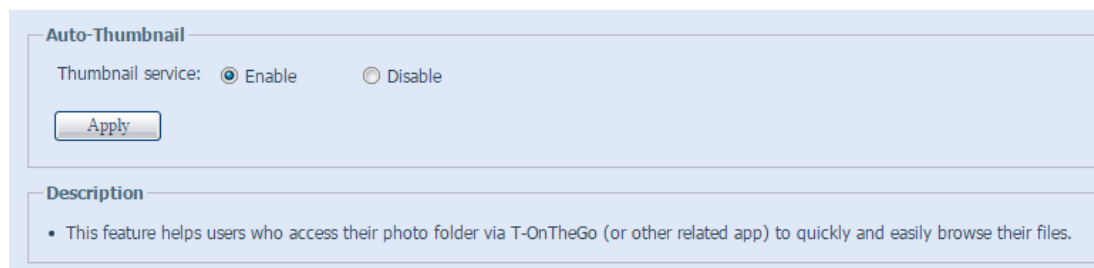

Auto-Thumbnail

Thumbnail service: Enable Disable

Description

- This feature helps users who access their photo folder via T-OnTheGo (or other related app) to quickly and easily browse their files.

Auto Thumbnail Configuration	
Item	Description
Auto Thumbnail Service	Press the Enable button to activate the auto thumbnail service.
Apply	Click "Apply" to confirm the changes.

Thecus ID

Creating a Thecus ID will give you full access to all that Thecus has to offer. After creating a Thecus ID, you'll receive a free* DDNS (i.e."yourname.thecuslink.com".) You can use your DDNS to easily access your NAS, make use of the mobile T-OnTheGo™ app, and share links to files with your friends. In the future, free cloud backup of your NAS configuration file will also be provided.

From here, it will display the current Thecus ID and DDNS information for the associated Thecus NAS system and also the port connection status. You can click logout if remote access is no longer needed.

If your Thecus NAS system is not currently logged in, or if DDNS has not yet been applied, then it can be done here.

- **Login Thecus NAS system:**

Simply input your existing Thecus ID and DDNS for this Thecus NAS then press **Apply**.

- **Create free DDNS for your Thecus NAS:**

With registered Thecus ID, you could create DDNS for your Thecus NAS by fill in valid Thecus ID and password. Then input desired DDNS name to complete DDNS creation.

DDNS settings

Thecus ID:

Password:

DDNS: .thecuslink.com

If you do not have a Thecus ID, please register a new account.

Description

For advanced My Thecus ID settings, please go to: <http://thecusid.thecuslink.com/mythecusid>

If you don't have a Thecus ID, click "Register" and the screen below will appear. Please fill in the required information and click Apply.

Create Thecus ID

Thecus ID:

Password:

Confirm Password:

First Name:

Middle Name:

Last Name:

Description

For advanced My Thecus ID settings, please go to: <http://thecusid.thecuslink.com/mythecusid>

Register Thecus ID	
Item	Description
Thecus ID	Input a valid email address. It will require confirmation to activate your Thecus ID.
Password	Input the password for your Thecus ID
Confirm Password	Re-input the password for your Thecus ID.
First Name	Input your First name
Middle Name	Input your Middle name

Last Name	Input your Last name
Apply	Click Apply to save your changes.

Once your ThecusID has been registered, you will be given access to a webpage providing more information (i.e. connection test, re-send password, etc.).

<http://thecusid.thecuslink.com/mythecusid/index.php>

Thecus Creator in Storage

My Thecus® ID

Home
Login
Forgot Password
Resend Activation Email

Thank you for using Thecus® NAS.

What is Thecus® ID?

A Thecus® ID is your account for everything you do with Thecus®. After creating a Thecus® ID, you'll get a free* DDNS, such as "wow.thecuslink.com". You can use your DDNS to easily access your NAS, make use of the mobile T-OnTheGo™ app, and share links to files with your friends. In the future, free cloud backups of your NAS configuration file will also be provided.

Please note that none of your information will be shared without your express permission.

*Your DDNS is guaranteed for the duration of the warranty of your Thecus® NAS.

VPN Client

To have this storage device join a Virtual Private Network, simply provide a VPN server IP address and a valid login user name and password. Once the input information has been confirmed, the connection will be made. This storage device will be capable of playing a role as a local device to communicate with other systems.

Home > Network Service > VPN Client

VPN Client

VPN Server IP:

Username:

Password:

Status:

Description

- Just support PPTP VPN server.

Once a connection has been successfully made, the granted IP address will be displayed in your status.

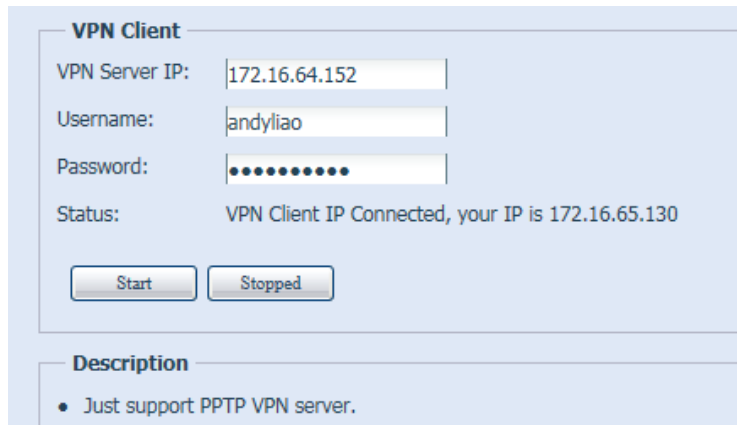

NOTE • Please notice that the connection to the VPN server only supports PPTP.

VPN Server

This storage device provides VPN server service and this allows remote access to this device via a secure connection. Settings can be found in the "Application Server" tab as seen below

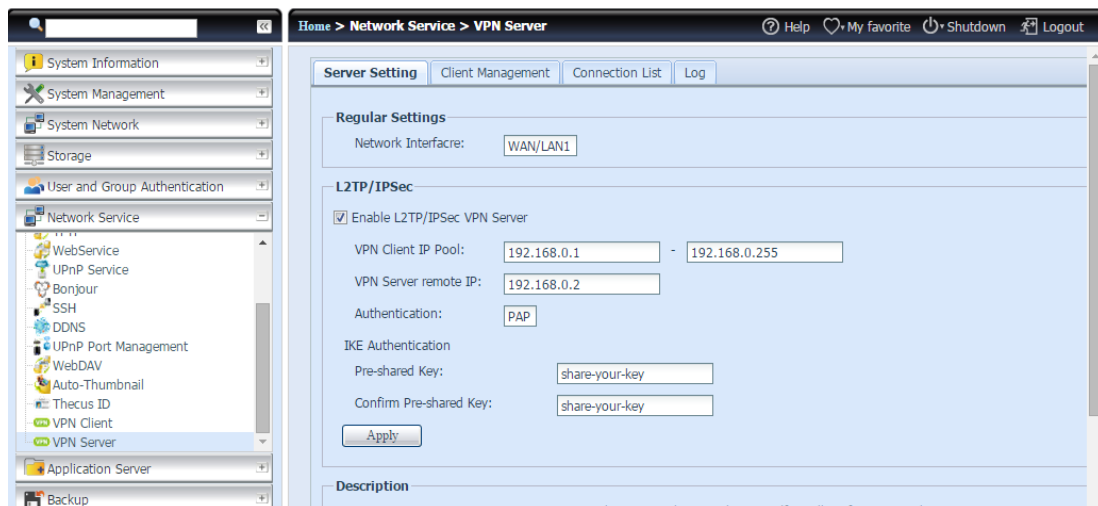

To setup your VPN server you must first choose the NIC interface from the drop down menu and complete the rest of the necessary information.

Below is a description of each item:

VPN Server	
Item	Description
Network Interface	Select the NIC interface to use for VPN server
Enable L2TP/IPSec VPN Server	Check to enable L2TP/IPSec VPN server service
VPN Client IP Pool	Input the IP range for client IP.
VPN Server remote IP	Input the IP for the VPN server for VPN client connection
Authentication	Input domain name with DDNS registry.
IKE Authentication	Internet Key Exchange for authentication while connection is made.
Pre-shared key	Input the key for connection authentication in between VPN client and server.
Confirm Pre-shared Key	Confirm the key
Apply	Click "Apply" to confirm the changes.

For the VPN client access control, simply click on "Client Management" tab. It will list all the users on this system and default "Allowed" for VPN connection. Un-tick the check box and confirm with the "Apply" button if users are prohibited from connecting with this VPN server.

User Name	L2TP/IPSec
pm1	<input checked="" type="checkbox"/>
pm2	<input checked="" type="checkbox"/>
pm3	<input type="checkbox"/>
aaa	<input checked="" type="checkbox"/>

To get the on-line connection list, click on the "Connection List" tab. It will display connected users with associated connection information.

Login Time	Uptime	User Name	Client Address	Service
Mon Jan 26 12:43	08:00:00	pm2	192.168.0.1	L2TP/IPSec

To retrieve the VPN service connection history information, click on "Log" tab. It will display the complete access log of the VPN service.

Date & Time	Event	Client Address
2015-01-26 12:43:22	user pm2 logged in on tty pts/0 intf ppp0	192.168.0.1 remote to 192.168.0.2
2015-01-26 12:42:49	Connect time 36.0 minutes. user logged out.	

NOTE

The VPN server only supports L2TP/IPSec connection.

Application Server

The Thecus IP storage supports build-in application such as iTunes server. The Thecus IP storage provides activation of the iTunes Server on the device. You will be able to play music files on this device with your iTunes client software directly. The following section shows you how.

iTunes® Server

With the built-in iTunes server capability, Thecus IP storage enables digital music to be shared and played anywhere on the network!

From the **Network Service** menu, choose the **iTunes Server** item, and the **iTunes Configuration** screen appears. You may enable or disable the iTunes Service from here. Once enabled, enter the proper information for each field and press **Apply** to save your changes.

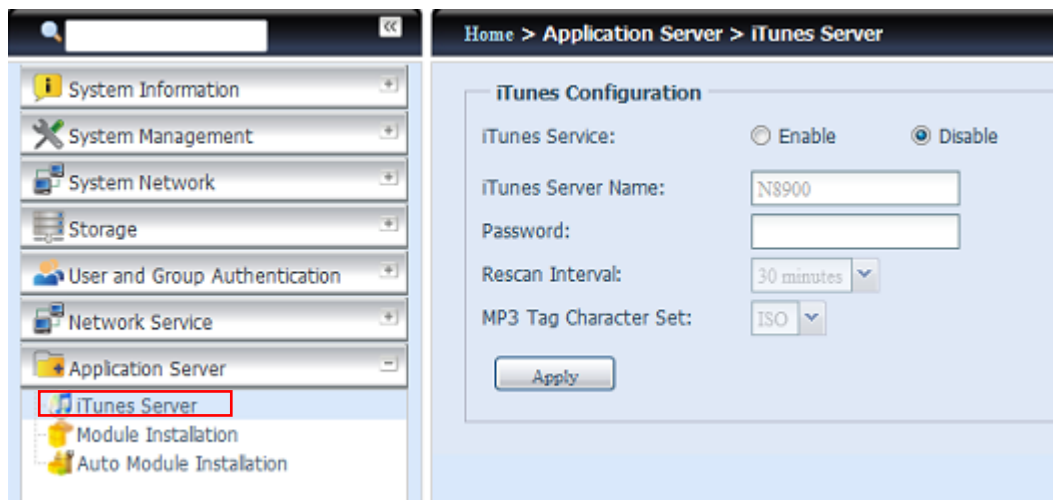

See the following table for a detailed description of each field:

iTunes Server Configuration	
Item	Description
iTunes Service	Enable or disable the iTunes Service.
iTunes Server Name	Name used to identify Thecus IP storage to iTunes clients.
Password	Enter a password to control access to your iTunes music.
Rescan Interval	Rescan interval in seconds.
MP3 Tag Encode	Specify tag encoding for MP3 files stored in Thecus IP storage. All ID3 tags will be sent out in UTF-8 format.

Once the iTunes service is enabled, Thecus IP storage will make all music located in the **Music** folder available for iTunes-equipped computers on the network.

App Installation

From the login page, other than admin, web disk and Piczza (Photo server) the app icon is a newly added feature for this FW release. After an app has been installed, a new option will be available to "Show in Login".

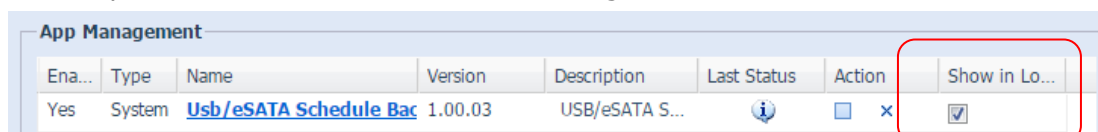

If this option is enabled then, when login to the system, the module icon will be available for all valid users to login through.



Auto App Installation

Choose the **Auto App Installation** item and the **Auto App Installation** screen appears. The default for this apps list is located online. So if the Thecus IP storage is capable to connect to Internet, then it will automatically link to the Thecus official website and list the available apps. Please refer the screen shot below.

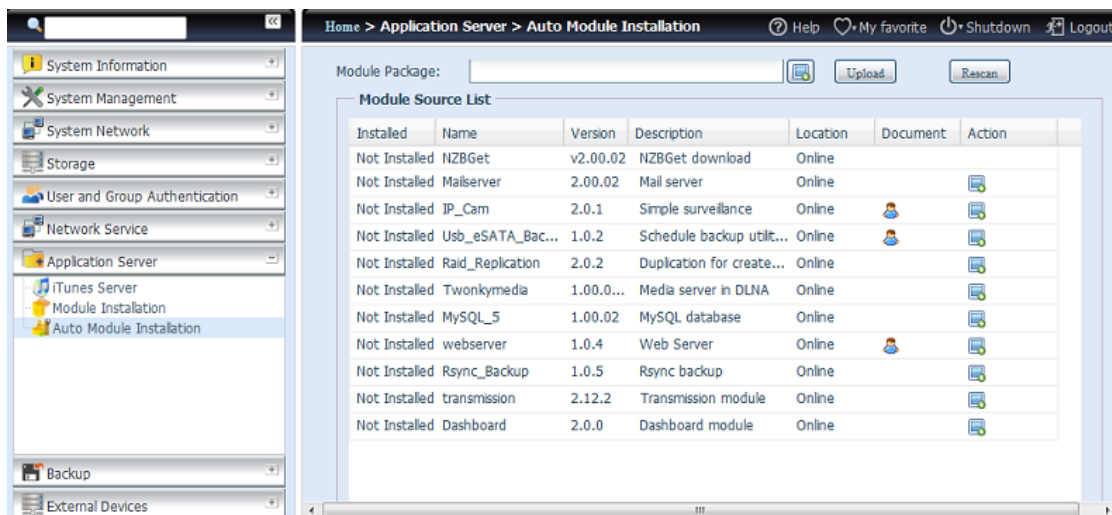

Auto Module Source List	
Item	Description
Installed	Status of module
Name	Module name
Version	The version of the released module
Description	The description of the module
Location	The module is either located on-line or disk
Document	The available documentation of the module
Action	To install or delete module. p.s. If the module list from on-line, then no delete option will be available
Rescan	Click to rescan from both on-line and disk

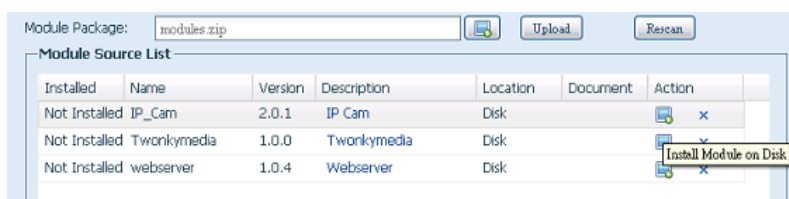

After clicking on "Action" to install a module, the module will become available under the list of Module Installation. Please go to Module installation and click "Enable" to activate the module.

Backup

There are a number of ways to back up data with the Thecus IP storage.

Dual DOM (N12000 series/N16000 series/N8900 series/N12850/N16850 only)

The unique Dual DOM feature can now perform "Auto Repair". The Thecus NAS will backup up to five versions of the system configuration either by the default timing of 1:00am every day automatically or as scheduled by the user.

This unique "Auto Repair" will be triggered if the primary DOM has a booting issue. In this instance, the 2nd DOM will take over the boot function. Then, the system will automatically load the most recent system configuration backup image to repair the primary DOM.

Task Name	Date	Firmware
backup_0000000	2002/01/01 01:00	5.00.00.12.dev

Rsync Target Server

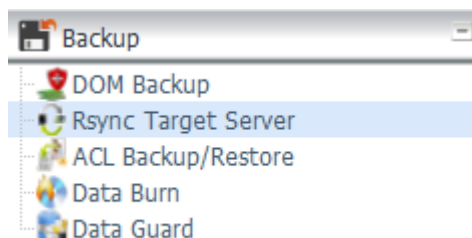

When it comes to backing up your data, it's very important to have flexibility. Data guard provides you with many options, including full backup for all shares, custom backup for selected shares and iSCSI volume backup. Being based on the Linux operating system, it is also much more stable and experiences much less frequent data loss during transfer than other remote backup systems.

-For this tutorial you will need to use Rsync Target Server (Step 1) and Data Guard (Step 2+3) under Backup for this client/server backup feature. It also can be named for function "Remote Replication".

Step 1 – Enabling Rsync on your target (backup) NAS

-Log in to your target (backup) NAS through the UI in your web browser

-Go to Rsync Target Server under Backup in the menu of the UI

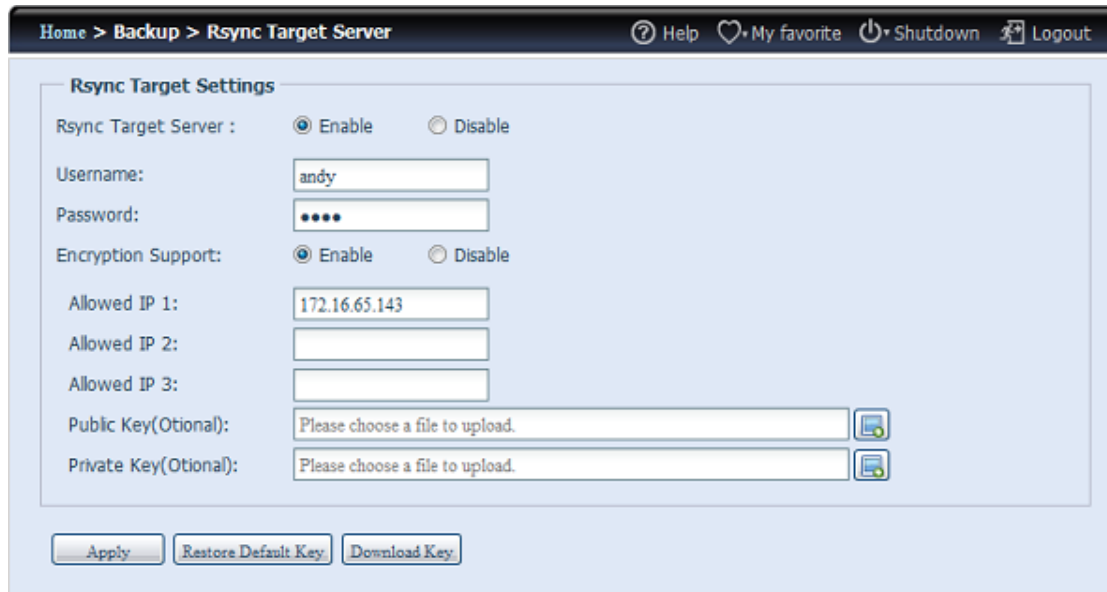

The screenshot shows a web browser window with the address bar displaying "Home > Backup > Rsync Target Server". The page title is "Rsync Target Settings". At the top right, there are navigation links: "Help", "My favorite", "Shutdown", and "Logout". The main content area contains the following settings:

- Rsync Target Server :** Enable Disable
- Username:**
- Password:**
- Encryption Support:** Enable Disable
- Allowed IP 1:**
- Allowed IP 2:**
- Allowed IP 3:**
- Public Key(Otional):**
- Private Key(Otional):**

At the bottom of the settings area, there are three buttons: "Apply", "Restore Default Key", and "Download Key".

1. Enable **Rsync Target Server**

2. Add a **username** and **password** (they can be different than your NAS's username and password)

3. Select **Apply**

NOTE

- You will need this user name and password while the data is going to remotely backup to this Rsync target server.

Now Rsync is turned on your NAS, which means it can be used as a target for Rsync backup, in other words, only the backup NAS needs to be activated in this way.

ACL Backup and Restore

The ACL backup and restore feature enables the system ACL (Access Control List) to be backed up on the RAID volume based to other location and restored if needed.

Let's look at the example bellow to see how it works.

We have one system with a RAID volume "RAID", select "Backup" to backup this RAID volume's ACL to other location. The current RAID volume "RAID" has share folder as listed on right hand screen shot.

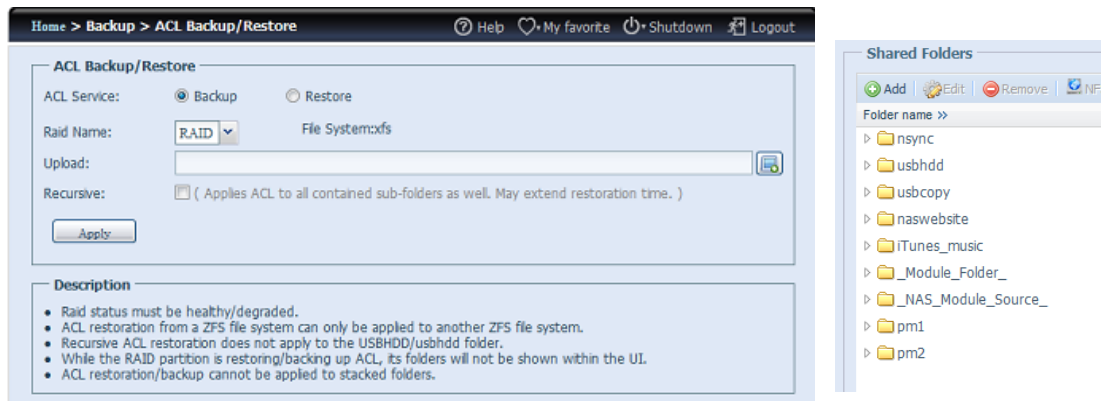

For the ACL restore, it can be restored in the same system or used in another unit. For example, let's restore the ACL backup file to another unit. This unit has a RAID volume "RAIDpm" with share folders as listed on right hand screen shot.

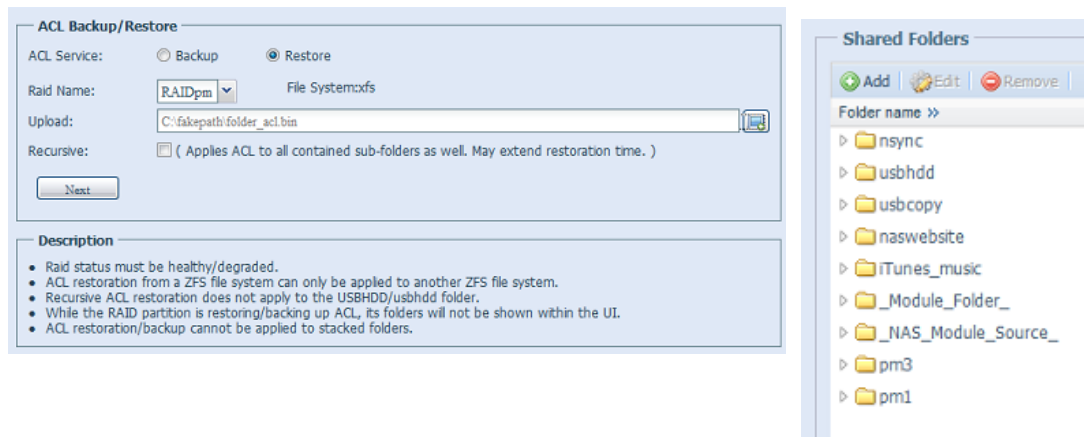

After inputting the ACL backup file and clicking the "Next" button, the system will show another screen to list the matched folders in between the backup file and this RAID volume. Just select the desired folders for the ACL restore.

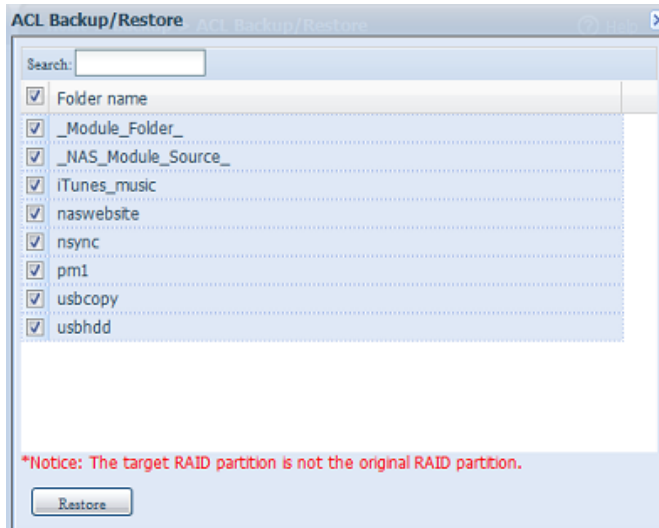

NOTE

- The ACL backup will only back to share folder level; it does not apply to its sub-layer.
- The ACL backup/restore can be used among ext3/ext4/XFS file system. ZFS can only be used with other RAID volume with ZFS file system created.
- If recursive has been checked during the ACL restoration, it will apply to all of its sub-folders with the same permission.

Data Burn

The data burn is featured to support 3 different modes of data burning for files/folders to and from image file and physical optical disk.

The 3 different modes are "Write Files/folders to disc", "Write image to disk" and "Write files/folders to image".

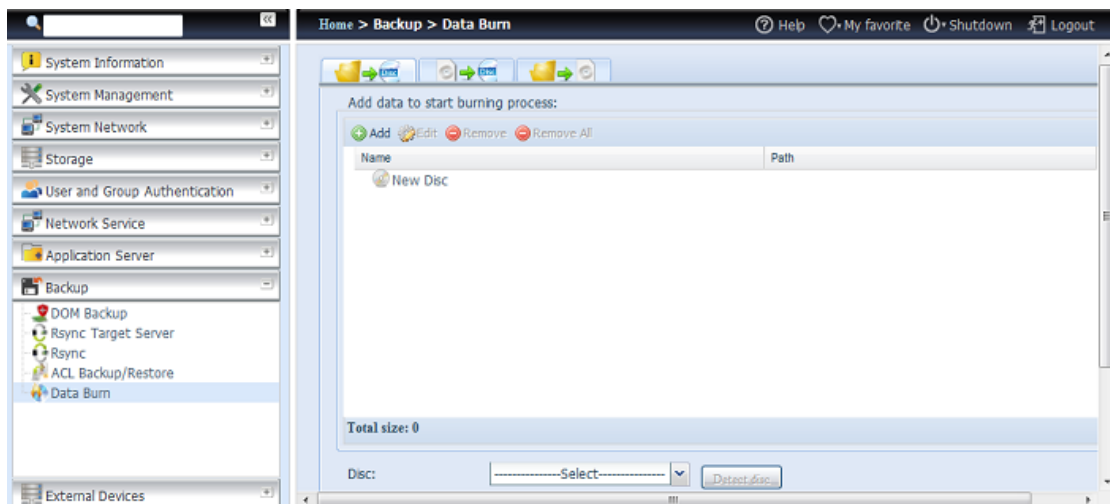

1. Write Files/folders to disc

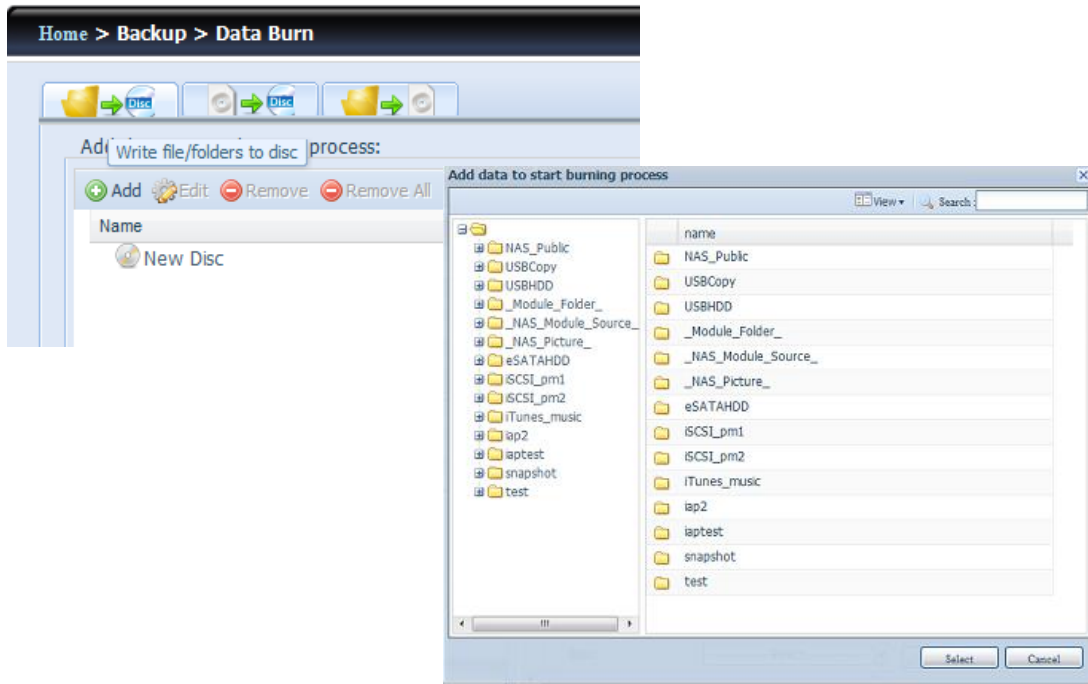

a. Click the Add button and the NAS share list appears.

b. Select files/folders which you would like to burn. All of the selected folders/files will be seen under the disc label name "New Disc". The disc label name can be changed by clicking on it and press "Edit" from menu bar. The selected folders/files also can be removed by clicking on them and then pressing "remove" or "remove all" for all selected items.

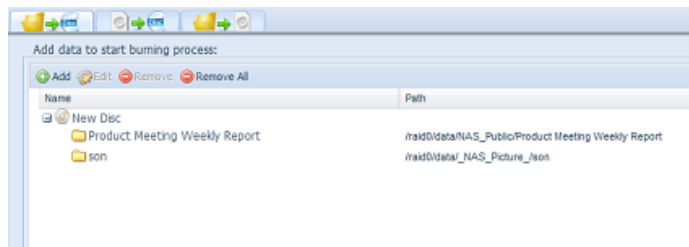

c. Select from the installed USB or SATA(for N6850/N8850/N10850) burning devices. Please click the "detect disc" button to check the status once the disc is inserted.

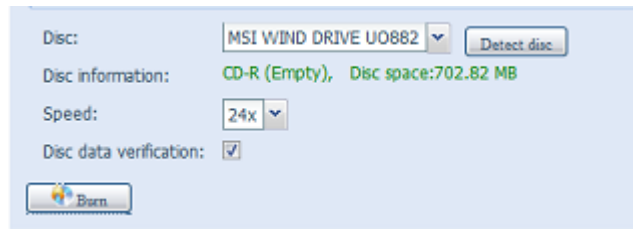

d. Select the burning speed from the drop down list.

e. Select whether disc data verification is required or not.

f. Click "Burn" to start disc burning.

2. Write image file to disc

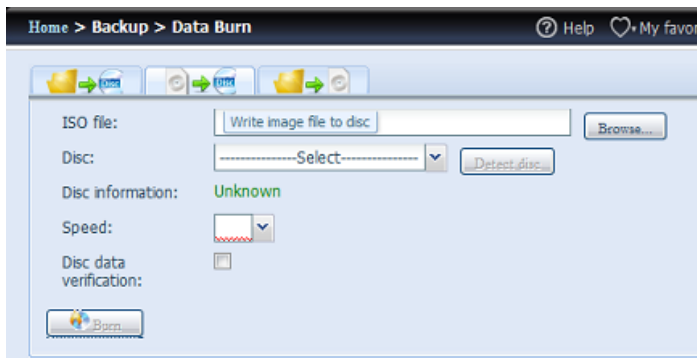

- a. Click "Browser" and the NAS share list will appear to locate the desired image file burn.

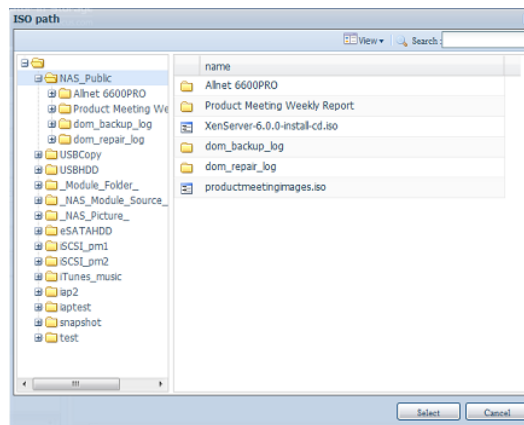

to

- b. Select the ISO file.

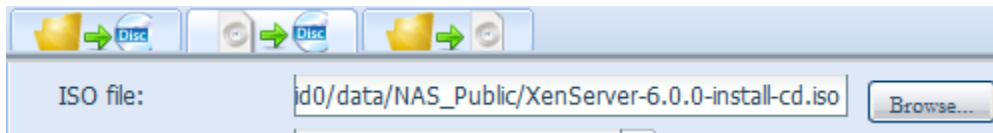

- c. Select from the installed USB or SATA(for N6850/N8850/N10850) burning devices. Please click the "detect disc" button to check the status once the disc is inserted.
- d. Select the burning speed from the drop down list.
- e. Select whether disc data verification is required or not.
- f. Click "Burn" to start disc burning.

3. Create image file from files/folders

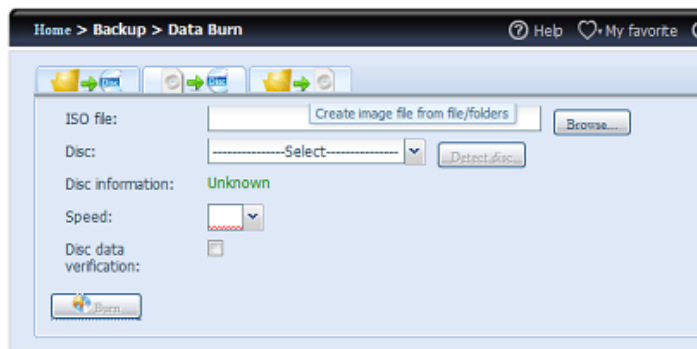

- a. Click the Add button and the NAS share list will appear.

- b. Select the files/folders which you would like to burn. All of the selected folders/files will appear under the disc label name "New Disc". The disc label name can be changed by clicking on it and pressing "Edit" from the menu bar. The selected folders/files also can be removed by clicking on them and pressing "remove" or "remove all" for all the selected items.
- c. Input the path where the ISO file is going to be stored, you can press the "Browse" button to have the share list appear.
- d. Input the ISO file name for burned image file.
- e. Click "Burn" to start the ISO file burning.

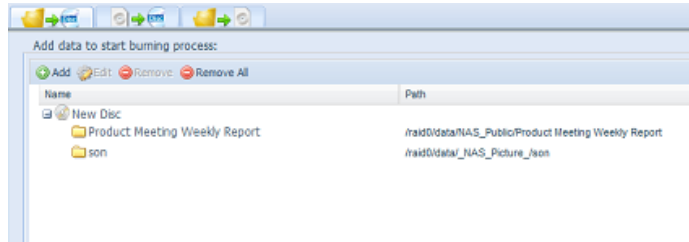

NOTE

- The data burn does not support rewriteable media if it has been burned with left space. On the other hand, the used rewriteable media will be erased first then carry on with burning.

Data Guard (Remote Backup)

Setting up your backup task and schedule on your source NAS

- Log in to your other NAS (your source NAS) through the UI in your web browser
- Go to **Data Guard** under **Backup** in the menu of the UI

-From the **Data Guard** function list, choose **Add**

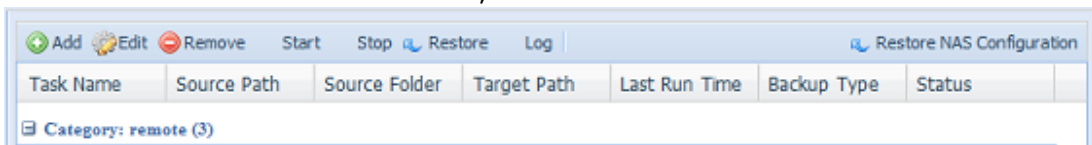

Remote Data backup	
Item	Description
Add	Add new task.
Edit	Edit select task.
Remove	Remove select task
Start	If associated task has been setup in schedule and like to start at once, click on to start task right away.
Stop	Stop the associated running task. The other scenario is if a task has been setup in real-time then clicking "Stop" can terminate the running process. Simple click 'Start" to re-start the real-time operation.
Restore	Restore the associated task
Log	Click to view the associated task in process details.
Restore NAS Configuration	Click to restore system configuration from selected destination to source unit. More details will describe in sections.

The data backup setup wizard appears as below, click on 'Remote Backup':



Then 3 different selections appear and can be chosen from:

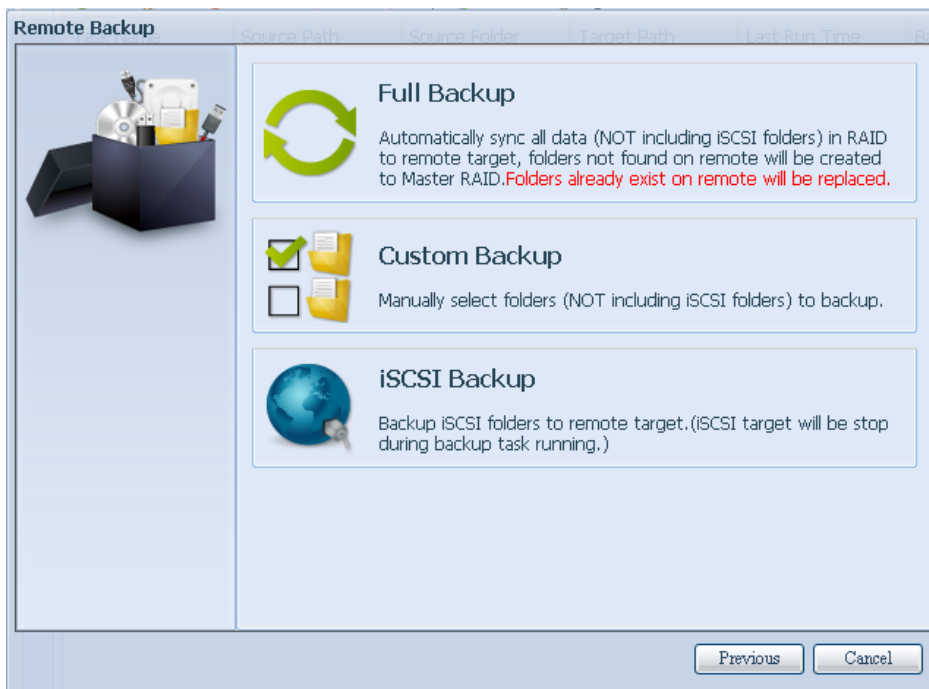

Remote Data backup	
Item	Description
Full Backup	The "Full backup" will have all shares from source backup to destination. It could also create shares automatically from destination if it is not existent. This only applies if the target server is the same model as the source.
Custom Backup	The "Custom backup" allows user to choose desired shares backup to destination.
iSCSI Backup	The "iSCSI backup" can backup iSCSI volume as single file to destination.

Full Backup

Click on full backup and the setup screen appear as below. Fill in the remote target IP (Destination) and port (need to be changed only if this port is already in use). If encryption is required then enable it. Please make sure the associated target server also has encryption enabled.

Carry on with inputting valid remote target server account name and password.

Remote Backup > Full Backup

Remote Target: 172.16.64.131 Port: 873

Encrypt with SSH: Off On

Account : cheryl

Password : *****

Connection Test

Previous Cancel

After the settings are complete, please click on "Connection Test". The source unit will try to connect with the associated target system. If a connection can be built up successfully then "Connection passed" will be prompted, otherwise "Failed" will appear.

Remote Target: 172.16.64.131 Port: 873

Encrypt with SSH: Off On

Account : cheryl

Password : *****

Connection Test

Connection test passed! Click Next to continue.

Click "Next" and more setting will appear.

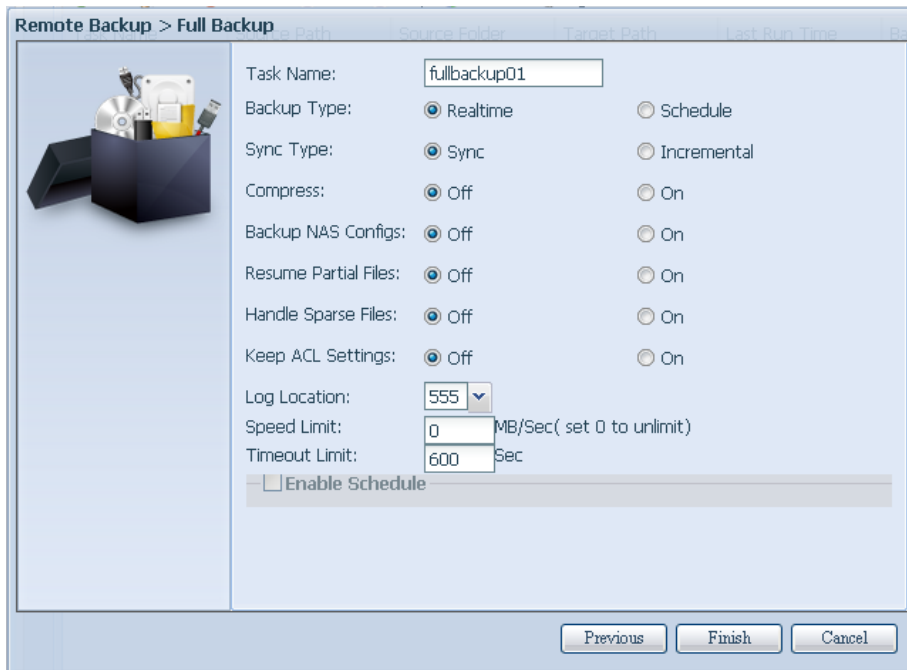

-Fill out all the necessary details and choose your parameters

Add Rsync Backup Task	
Item	Description
Task Name	This is how this task will appear in the task list.
Backup Type	<p>Real time: It will backup folders/files from source to target on the fly. On the other hand, any changes from the source will back up to the target right away.</p> <p>Schedule: The task will start only according to the schedule.</p>
Sync Type	<p>Sync mode: Makes your source match your target completely; deleting and adding files on your target as they are deleted and added on your source.</p> <p>Incremental Mode : Makes your source match your target and keep all old files; adding files on your target as they are added on your source, but NOT deleting files on your target as they are deleted on your source.</p>
Compress	With this option, compress the file data as it is sent to the destination machine, which reduces the amount of data being transmitted – something that is useful over a slow connection.
Backup NAS Config	Enabling this will back up the source unit system configurations to the designed path on the target system.
Handle Sparse File	Try to handle sparse file efficiently so they take up less space on the destination.
Keep ACL Setting	It will backup not just data itself but also ACL configuration with associated folders/files.
Log Location	Choose the folder to save the log details while the task is executed.
Speed Limit	Input the bandwidth control for data backup operation.

Timeout Limit	Setup the timeout when trying to build up a connection in between the source and the target system.
Enable Schedule	If backup is set as "Schedule", please input the related period and time.

After the required fields are filled and the parameters are setup, click 'Finish' to complete. The data guard task will appear in the list as shown below.

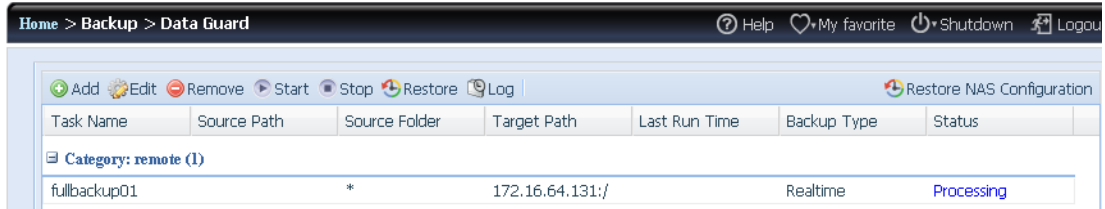

From the task list, you can now see the newly added task "fullbackup01". The backup is setup as "real time". From the status field, "Processing" can be read as the back-up is performed on the fly.

Custom Backup

The custom backup setting is similar to the full backup. The only differences are explained below:

1. Inputs the share folder name of target sever where the source is going to backup. The sub-folder can be left as blank.

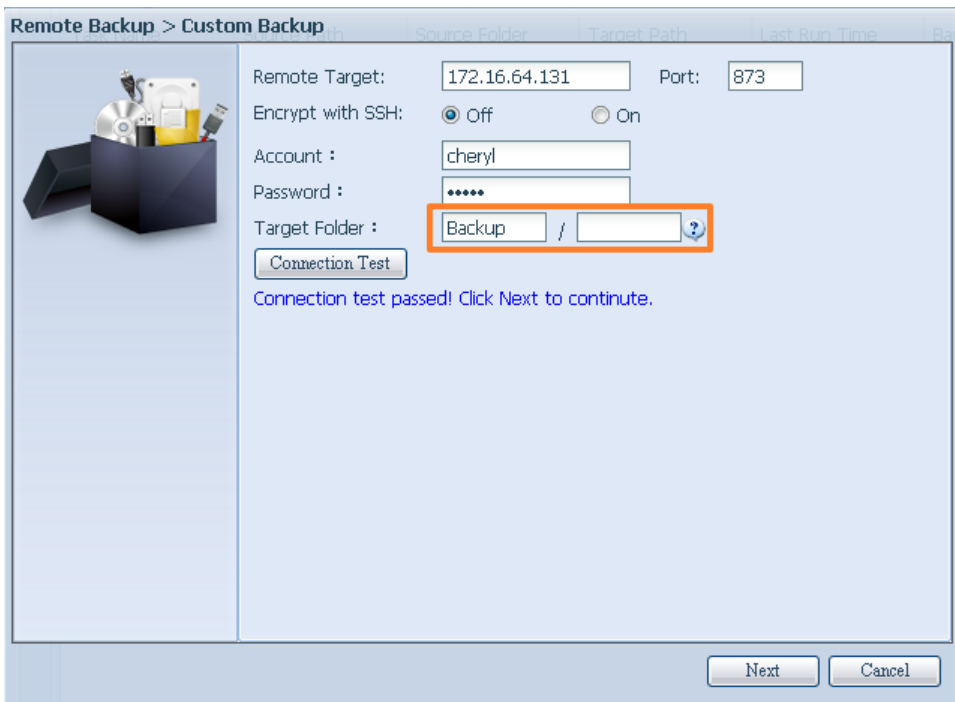

2. Select the source share folder(s) which are desired to be backed up to the target server. You can also click on "Select All" from top right corner check box.

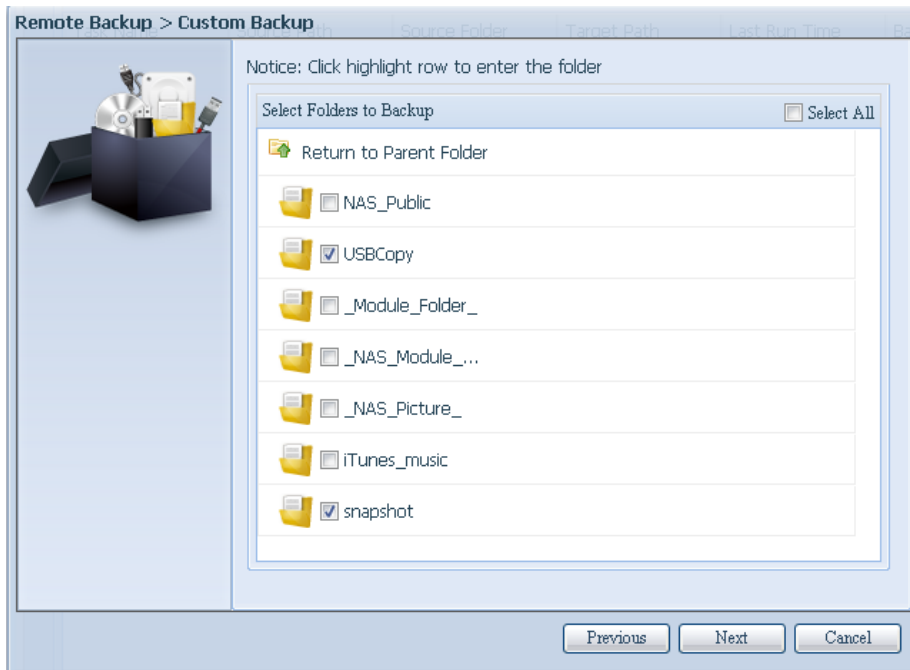

3. Click "Next" and more setting appears. These are the as the settings for "Full backup"

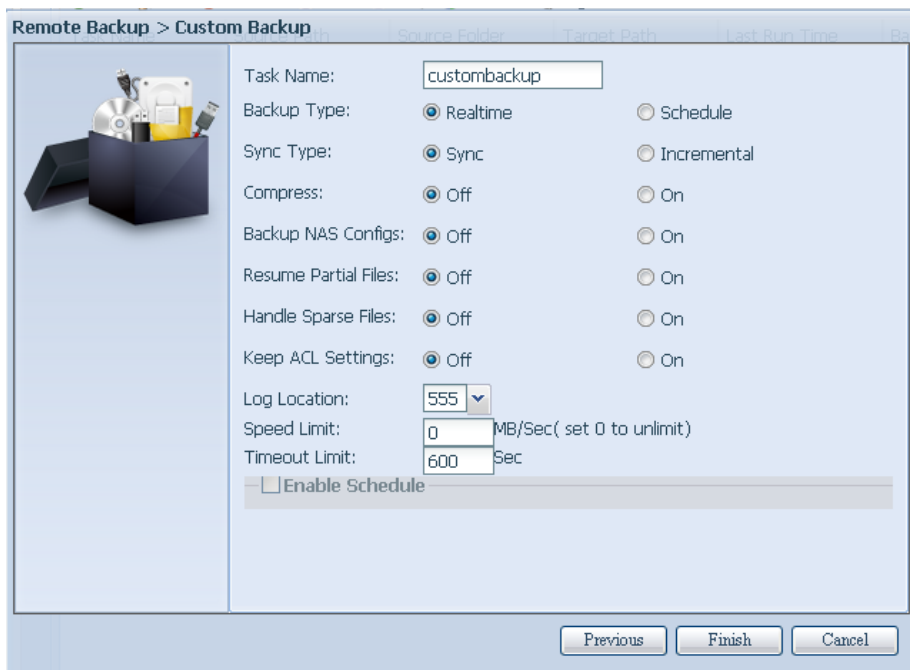

4. Click "Finish" and the data guard task will appear in the list as shown below.

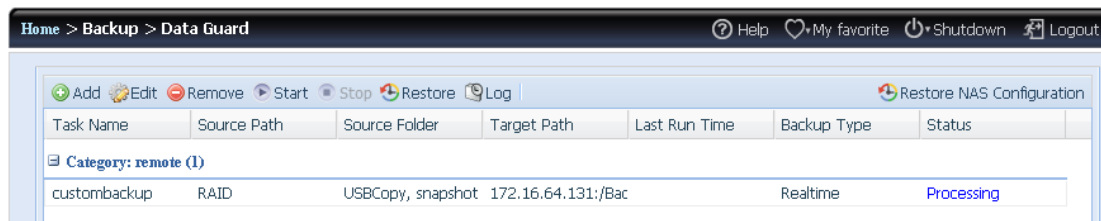

From the task list, you can now see the newly added "customback01". This backup is setup as "schedule".

iSCSI Backup

If the source unit contains iSCSI volume, it can be backed up to the target unit as a single file. The procedure is the same as for the previous "Full backup" and "Custom backup", select "iSCSI backup" from data guard wizard.

1. Inputs the share folder name of the target sever where the source is going to backup. The sub-folder can be left as blank.

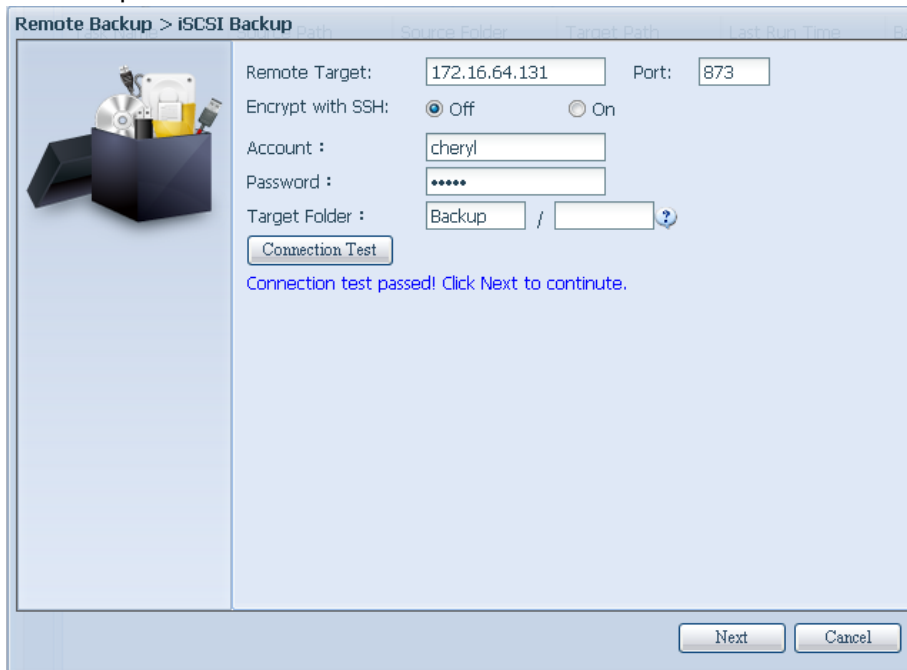

The screenshot shows the "Remote Backup > iSCSI Backup" wizard. On the left is an icon of a server rack. The main area contains the following fields and controls:

- Remote Target: Port:
- Encrypt with SSH: Off On
- Account:
- Password:
- Target Folder: /
- Connection Test button
- Message: "Connection test passed! Click Next to continue."

At the bottom right are "Next" and "Cancel" buttons.

2. Select the iSCSI target volume which you wish to back up to the target server.

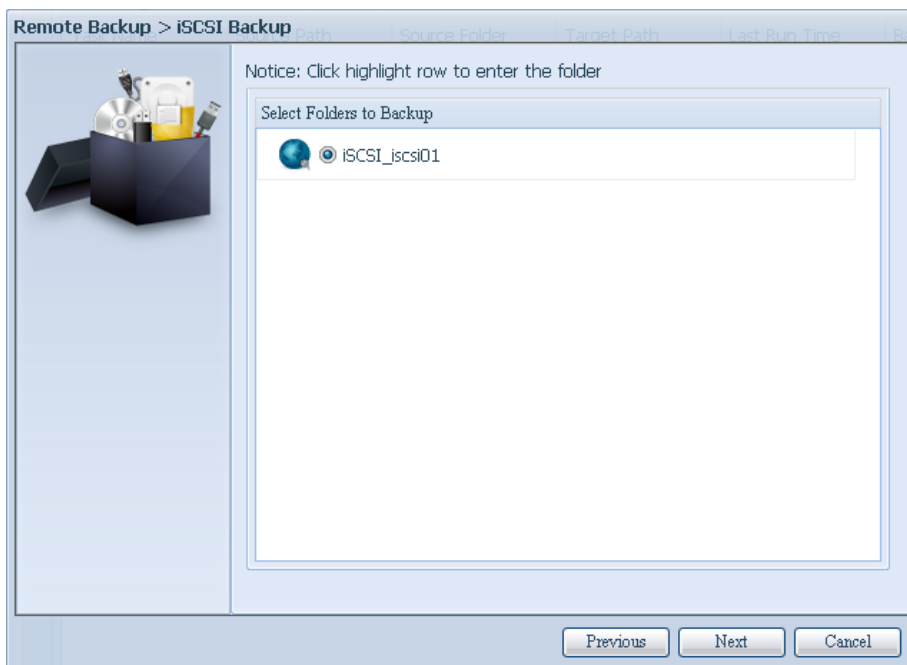

The screenshot shows the "Remote Backup > iSCSI Backup" wizard at step 2. On the left is the same server rack icon. The main area contains:

- Notice: Click highlight row to enter the folder
- Select Folders to Backup window with a list containing one item: iSCSI_iscsi01

At the bottom are "Previous", "Next", and "Cancel" buttons.

3. Click "Next" and more settings will appear. It is slightly differing from "Full backup" and "Custom backup". Only "Schedule" backup is supported with less options.

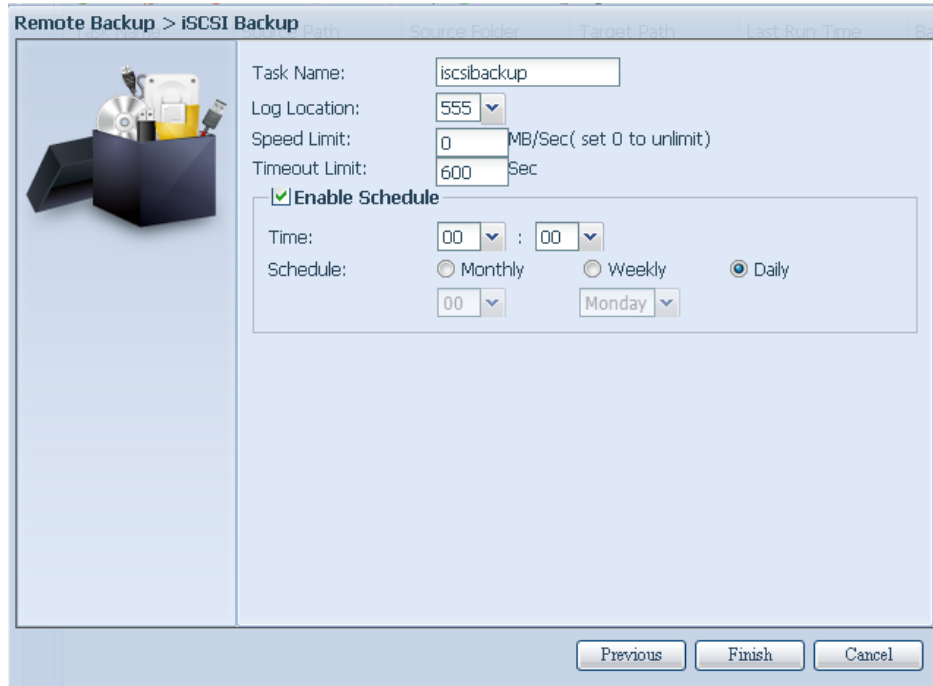

4. Click "Finish" and the data guard task will appear in the list as shown below.

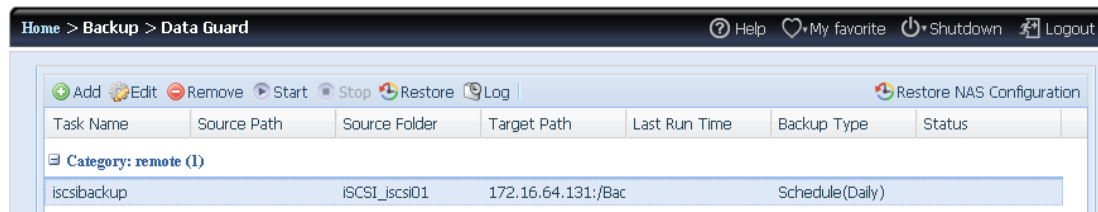

From the task list, you can now see the newly added "iscsiback". This backup is setup as "schedule".

NOTE

- The source folder name will use iSCSI_+target volume name. So here it is displayed as "iSCSI_pmtest". pmtest is the iSCSI target name when the iSCSI target was created.

The iSCSI backup can see the result as below. The task "iSCSI_pmtest" has backup to target 172.16.66.131 and share folder NAS_Public with file "iSCSI_pmtest".

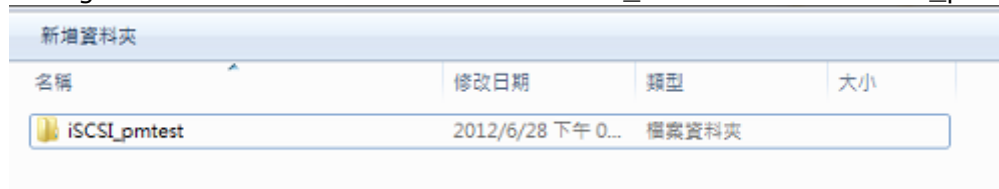

Restore

To restore a backup from the backup task, simply select a task from the task list then click "Restore" from the function bar. The restore task will start to have the associated files/folders from the target server restored to the source.

Task Name	Source Path	Source Folder	Target Path	Last Run Time	Backup Type	Status
Category: remote (3)						
fullbackup01	/	*	172.16.66.11...	2012/06/29 ...	Realtime	Processing
iscsiback01	/	iSCSI_pmtest	172.16.66.11...	2012/06/29 ...	Schedule	Finish
customback0	/raid0/data	test1, test2	172.16.66.11...	2012/06/29 ...	Schedule	Finish

NOTE

- To restore task with backup type set as "Real time", first you need to stop the task then you can proceed with the restore operation.

Restore NAS Configuration

This is a useful feature if the system configuration needs to be restored to a brand new unit. Let's go thru the following example to see how it works.

The original source system has 3 RAID volume, "RAID", "RAID10" and "RAID20", and has backed up the system configurations to the target server.

Mas... RAID	ID	RAID Level	Status	Disks Used	Total Capacity	Data Capacity
*	RAID	J	Healthy	10	929 GB	11.4 GB / 928.7 GB
	RAID01	J	Healthy	9	929 GB	928.5 GB
	RAID20	J	Healthy	8	929 GB	928.5 GB

The brand new source unit only has a 1 RAID volume 'RAID'.

Mas... RAID	ID	RAID Level	Status	Disks Used	Total Capacity	Data Capacity
*	RAID	J	Healthy	10	929 GB	11.4 GB / 928.7 GB

- When adding a new backup task with "Full backup" or "Custom backup" and enabling the option "Backup NAS Config" as shows below, the source unit system configurations are then backed up to the designed path on the target system every time the task is executed.

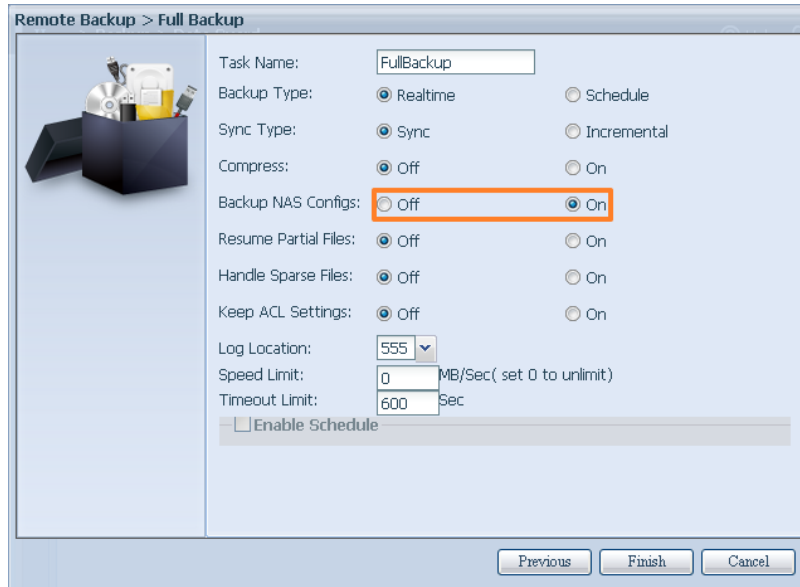

2. Click on "Restore NAS Configuration" and the screen shown below will appear. Input the target server's IP address where the system configuration has been backed up, and necessary authentication info. Confirm by doing a "Connection Test" to make sure the communication between the source and the target server works.

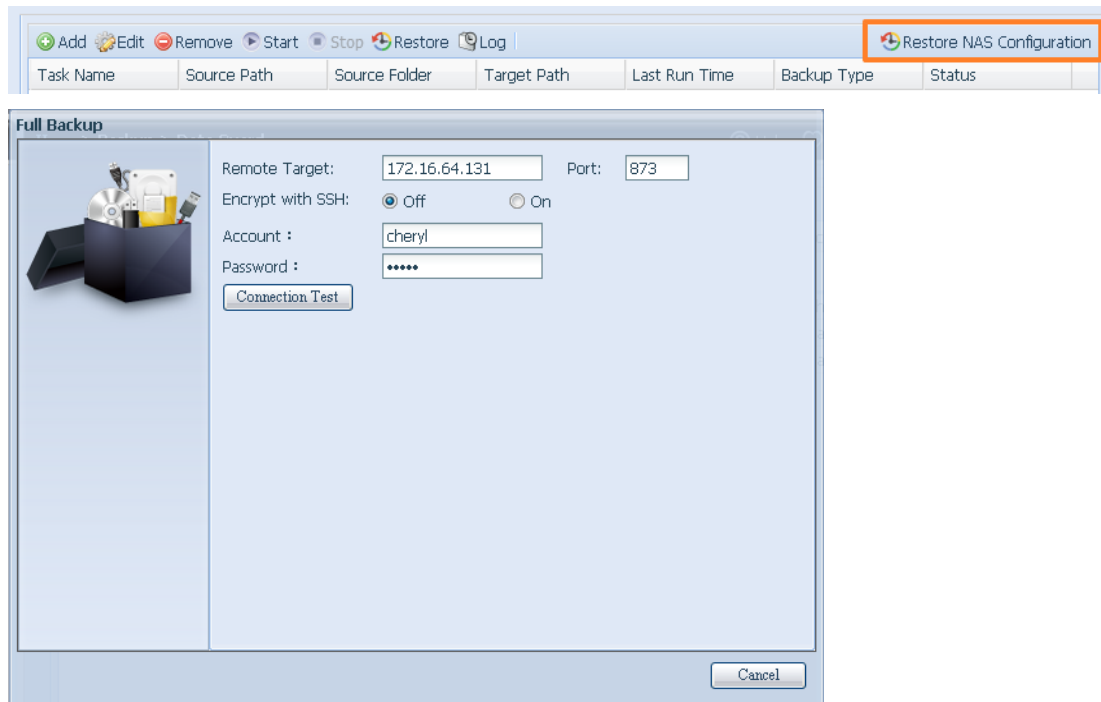

3. Click "Next" and a screen will appear as shown below. It has the listed available system configuration backup files. Select the one you want and click next. You also have the option to download the current system configuration before restoring from the backup file.

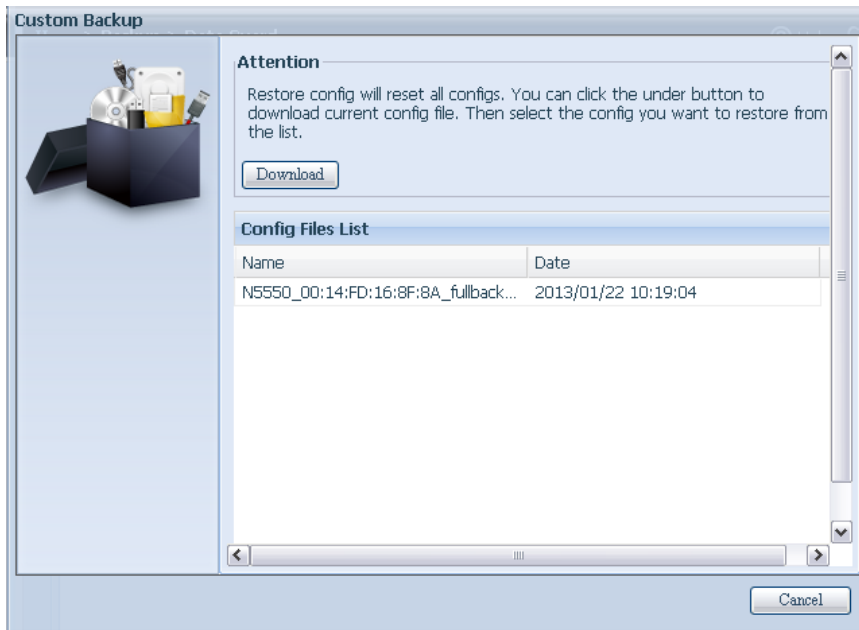

4. After clicking "Next", a screen will appear as shown below. Listed on the left hand side, you will see the configuration backup details which contain the 3 RAID volumes. On the right hand side, you will see a list of single "RAID" volume. You may roll back to previous page to recall the example we have taken.

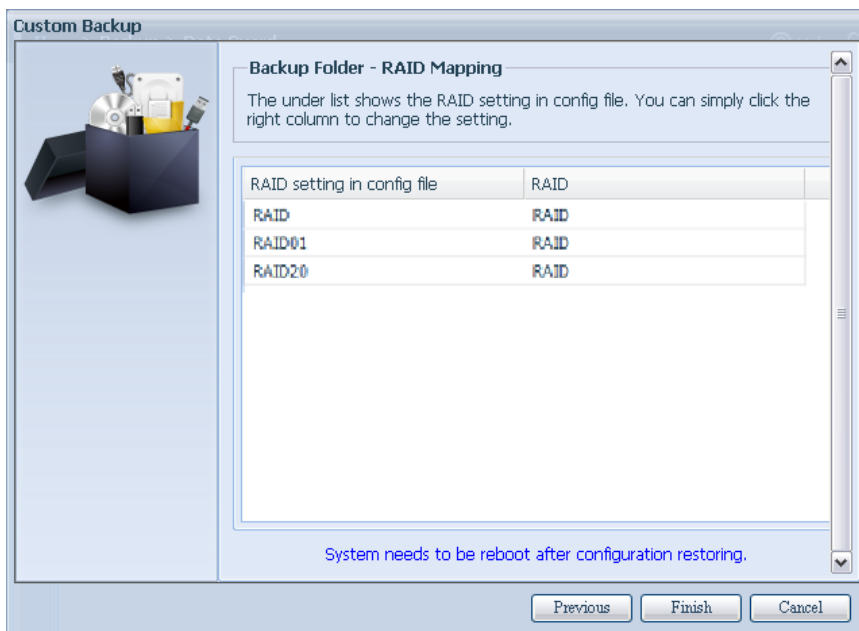

5. The backup configuration has different numbers of RAID volume than the current system (3 vs 1). It can be kept as the RAID volume mapping arranged by the system, then carry on to click "Finish". This means that all 3 RAID volumes configuration such as share folder etc. will all restore to the current unit in the RAID volume "RAID".
6. In other circumstances, if the current unit contains 2 RAID volumes, then it can be chosen from the left hand side of system backup configuration RAID volume list which RAID volume to map to the current system.

Let's see the following screen to make it clearer.

The current system has 2 RAID volumes, "RAID" and "RAIDa". Select the RAID volume from the backup configuration volume list which is going to be mapped to the RAID volume of the current system. Simply click on the right hand side of "RAIDa" and a drop down list will appear. Now you can choose which volume to map with. In this case the "RAID01" volume from the system backup configuration will be mapped to the volume "RAIDa" of the current unit. Once again, it means all the shares that were created in the volume "RAID01" will be restored to volume "RAIDa" of the current system.

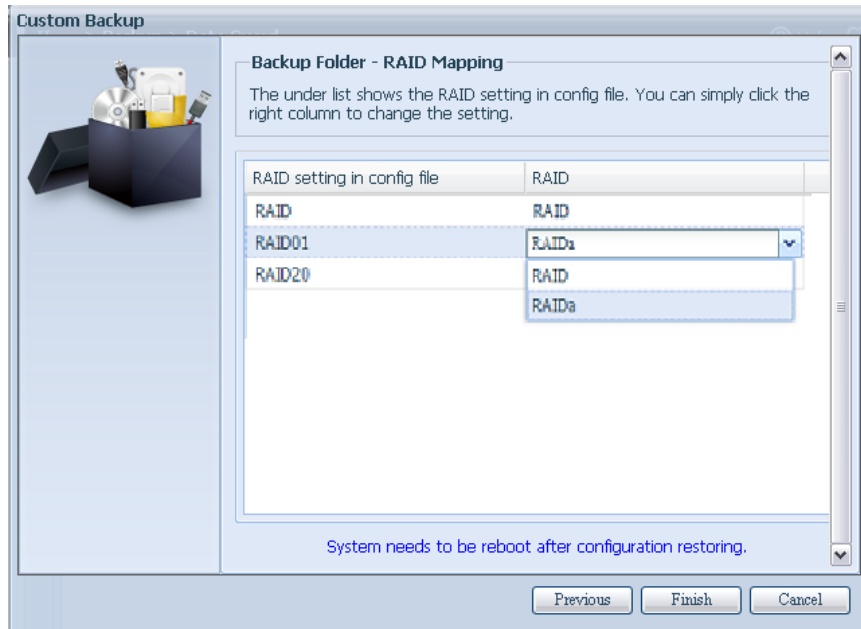

Data Guard (Local Backup)

The Thecus product provides complete backup solution between Thecus NAS systems as well as between folders of local systems. For remote data guard backup, please refer to [Data Guard \(Remote backup\)](#).

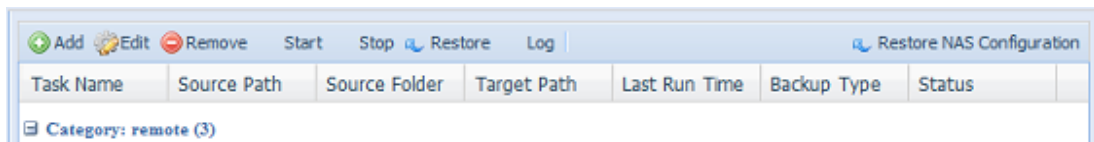

Local Data backup	
Item	Description
Add	Add a new task.
Edit	Edit selected task.
Remove	Remove selected task.
Start	Click on start to start a scheduled scan task right away.
Stop	Stop the associated running task. Also can be used if a task has been setup as real-time, clicking "Stop" can terminate the running process. Simply click 'Start' to re-start the real-time operation.
Restore	Restore the associated task.
Log	Click to view the associated task process details.
Restore NAS Configuration	Click to restore the system configurations from a selected destination to a source unit.

-From the **Data Guard** function list, select **Add**. The data backup setup wizard appears as below, click on "Local Backup":



The local backup has 6 different selection you can choose from.



Local Data backup	
Item	Description
Import	This is associated with external devices which are added to the system such as USB disk. You can select a folder from an external device and import it to the NAS as a share folder.
Copy	Copy folder to folder or NAS folder to external device or external device to NAS folder. This backup is within folder level.
Realtime Backup	The task will be executed on the fly between the source and the target. In other word, any changes made at the source will sync to the destination immediately.
Schedule Backup	The task will be executed on schedule between the source and the target.
iSCSI Backup	The iSCSI volume will be backup to the destination as a single file.
iSCSI Import	The iSCSI file can be imported from the iSCSI backup back to the destination as an iSCSI volume.

1. **Import:** click on "Import" and a screen will appear as below.
If there is an external device installed on system such as USB disk, then it will be listed in the Source pane.

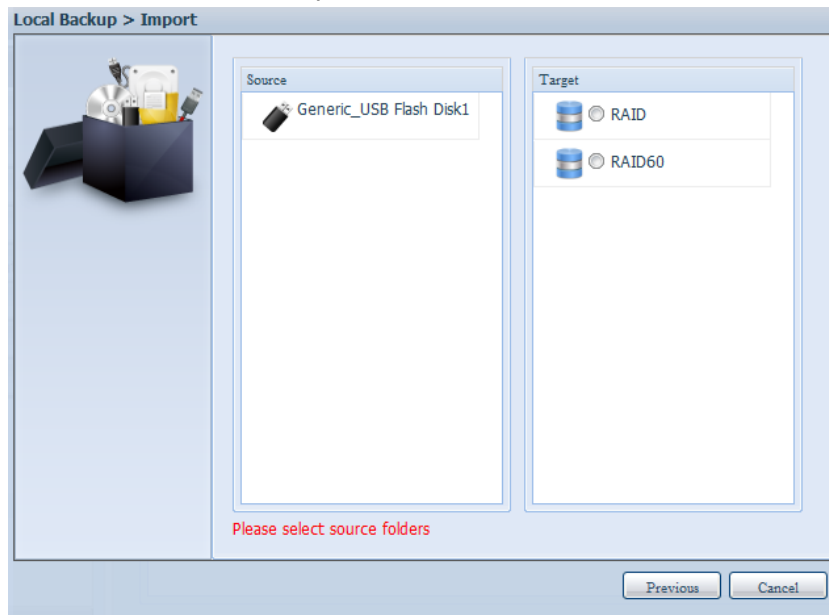

Click on the associated external device and the contain folders will be listed. Select the folders that are going to be imported to the NAS and select the available RAID volume which is listed in Target pane.

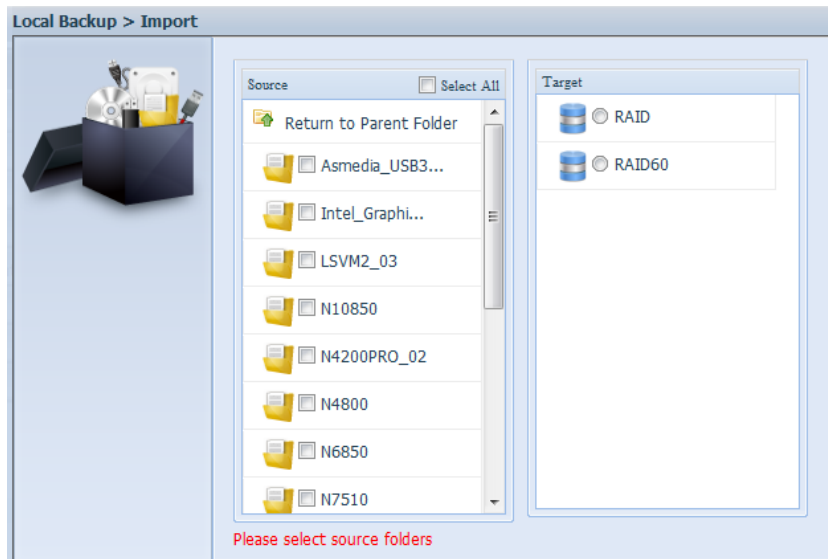

In here, we have selected the "Intel Graphi..." and "N10850" folders from the external device and imported them to the NAS under the RAID60 volume.

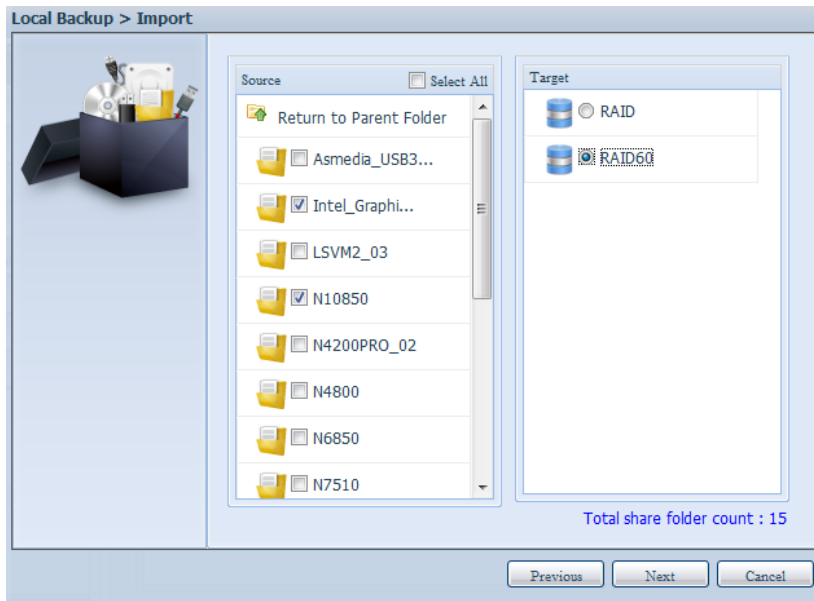

Next, please select the path from the drop down list to save the log. Also, give the access permission whether these selected folders will be "Public" or not after the import.

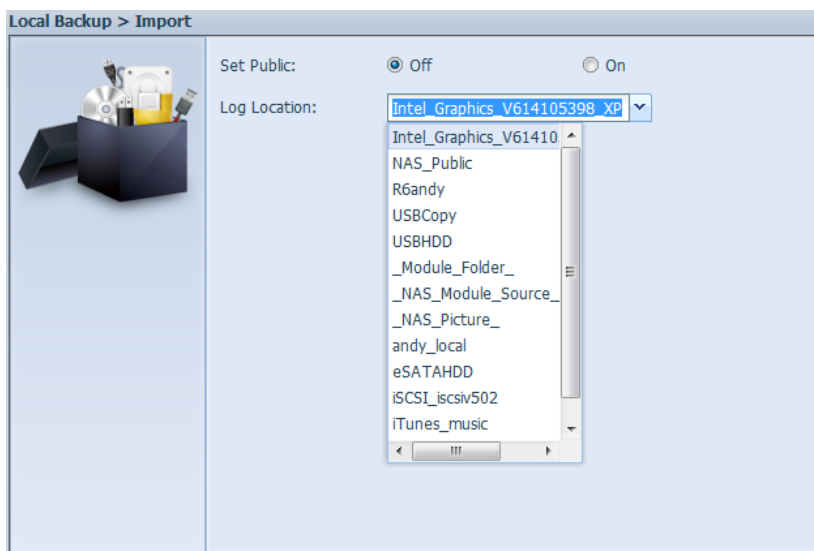

Read the notes and check the "Accept" box for confirmation. If a share name already exists for the import, then the import will be rename automatically to "existing share name -1".

For example, if the NAS RAID volume "RAID60" already has a folder named "Intel_Graphics_V614105398_XP", the import folder will then be rename to: "Intel_Graphics_V614105398_XP-1".

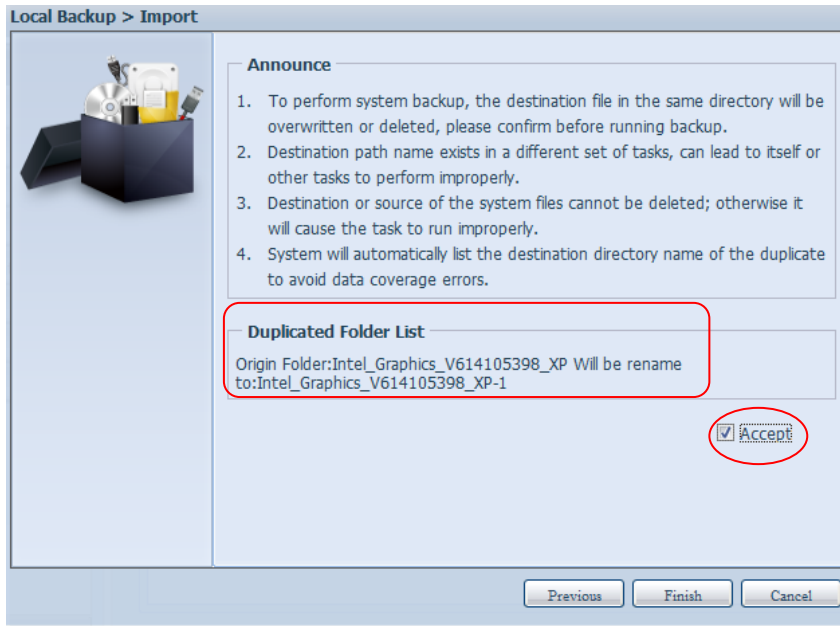

Now, you will see in the data guard task list that you have created a task .

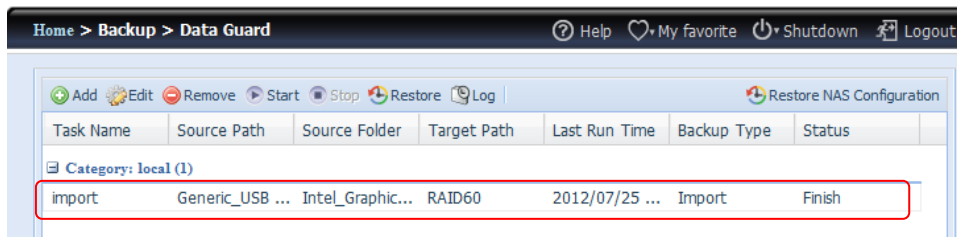

And that the system has created 2 new share folders from the task just created.

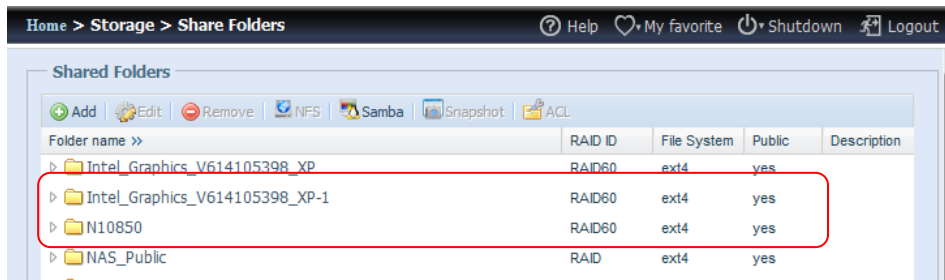

2. **Copy:** click on "Copy" and this screen appears. 3 different options can be selected, folder to folder, folder to external device or external device to folder.



Folder to Folder

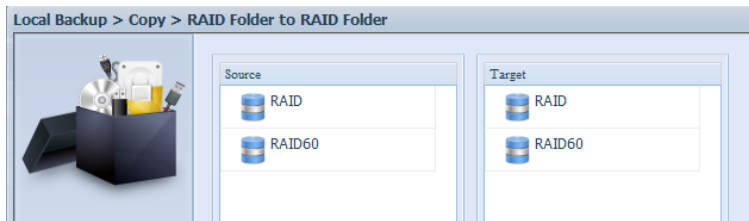

Folder to external device

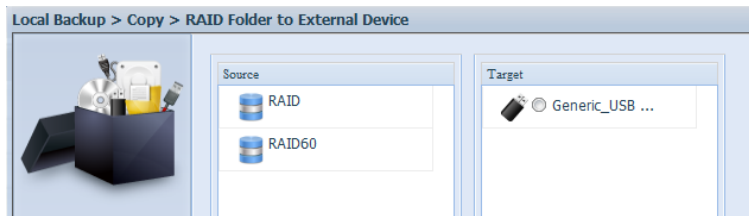

External device to Folder

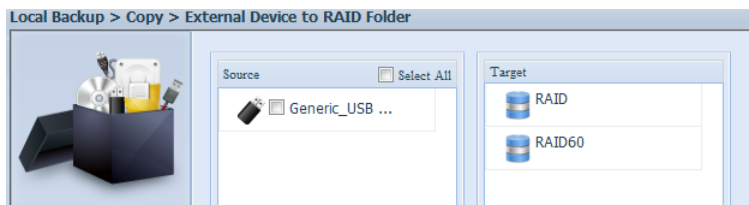

Let's take "Folder to External device" as an example. In the source pane, select the desired RAID volume and its associated folder list will appear; same method in the target pane for the associated external device.



Select a folder from the source pane which is going to be copy over, then select in target pane it's destination.

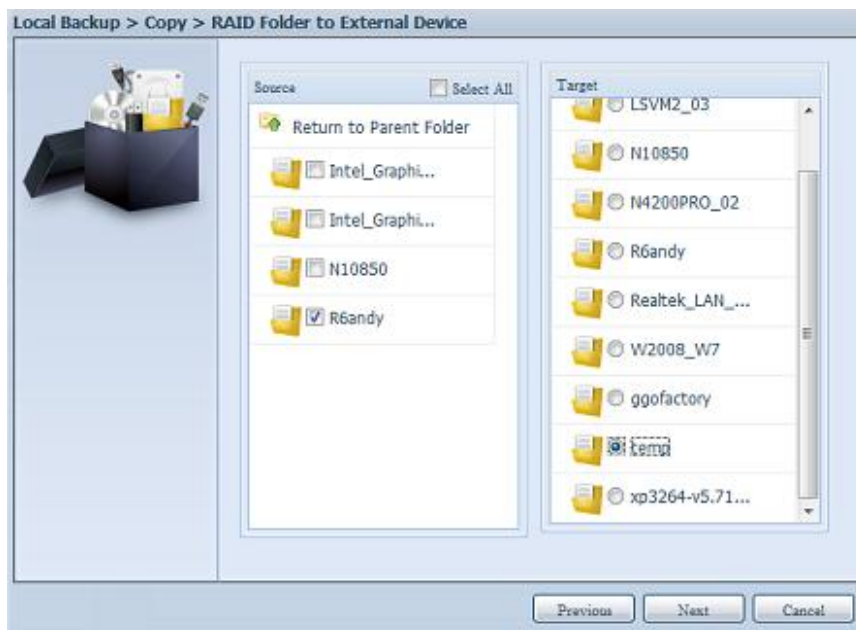

Choosing the sync type, "Incremental" or "Sync", and select the log path from the drop menu list.

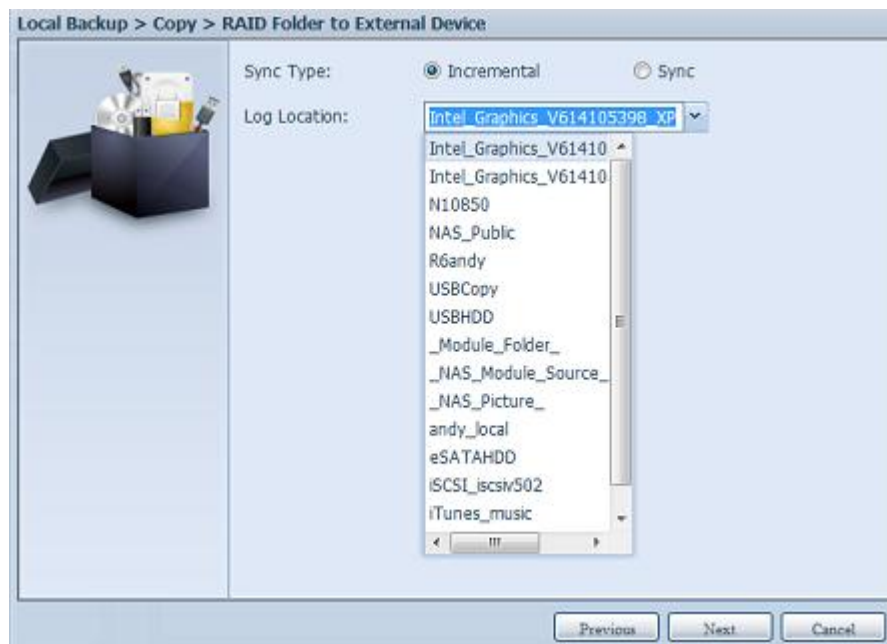

Read the notes and check the "Accept" box for confirmation.

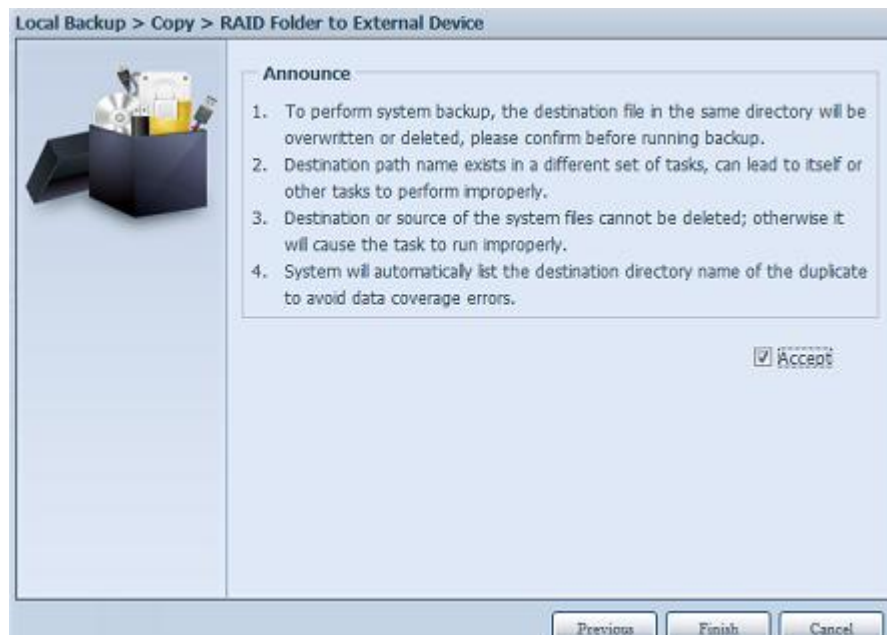

Now, you will see in the data guard task list that you have created a task.

Task Name	Source Path	Source Folder	Target Path	Last Run Time	Backup Type	Status
Category: local (2)						
import	Generic_USB ...	Intel Graphic...	RAID60	2012/07/25 ...	Import	Finish
copy	RAID60	R6andy	Generic_USB ...	2012/07/25 ...	Copy	Finish

3. **Realtime Backup:** click on "Realtime Backup" and this screen will appear. 2 different options can be selected from, folder to folder, folder to external device.

Let's take "Folder to Folder" backup for example. Select from the source pane the folder "NAS_Public", then select its destination in the target pane folder "R6andy".

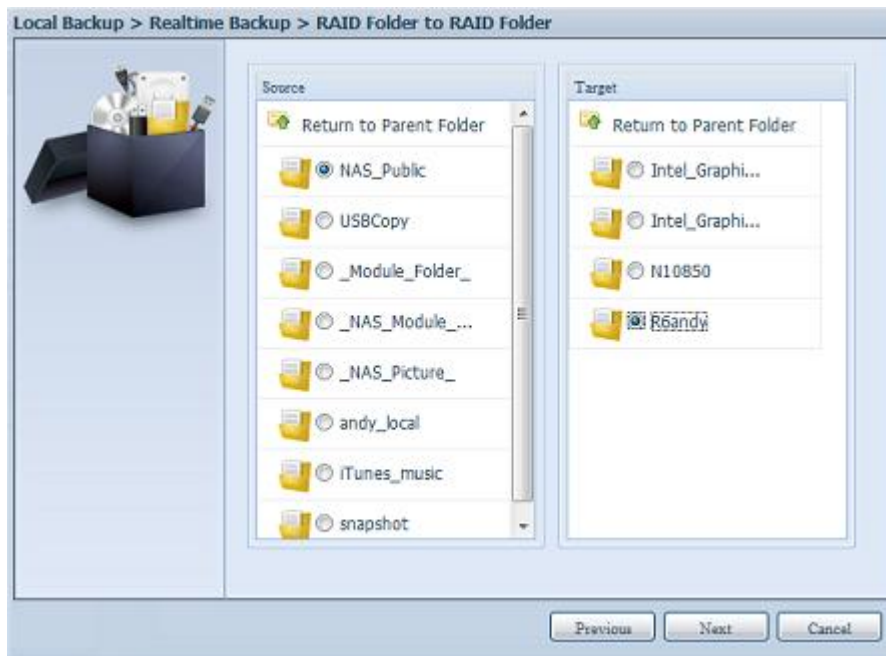

Next, fill in the task name and related settings.

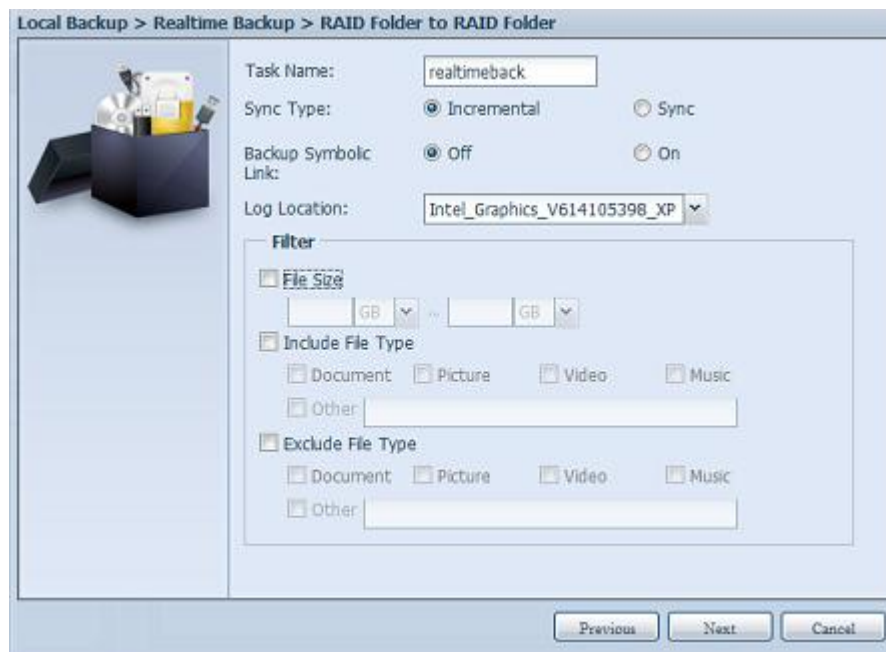

Realtime Backup	
Item	Description
Task Name	Input the task name, length limited to 4~12 characters.
Sync Type	Select "Incremental" or "Synchronize".
Backup Symbolic Link	Choose to backup symbolic link which is included in the source.
Filter	<p>The filter can be set to be executed only in certain circumstances. If none of them has been selected, it will do the real time backup from the source to the destination in full.</p> <p>File size: From xx ~ xxx If xx=1 and xxx blank then only file size > xx will execute real time backup. If xx=1 and xxx=2 then only size in between xx and xxx will execute real time backup. If xx blank and xxx=2 then only file size < xxx will execute real time backup.</p> <p>Include File Type: Only the associated file format will do the real time backup.</p> <p>Exclude File Type: The excluded file format won't be included in the real time backup.</p> <p>For document file format: doc, xls, pdf, docx, xlsx, txt, ppt, pptx, html, htm</p> <p>For picture file format: jpg, bmp, tif, png, pbm, tga, xar, xbm</p> <p>For video file format: avi, mpg, mp4, mkv, fli, flv, rm, ram</p> <p>For music file format: mp3, wav, wma, acc, dss, msv, dvf, m4p, 3gp, amr, awb</p> <p>User defined can be input in other box.</p>

Read the notes and check the "Accept" box for confirmation.

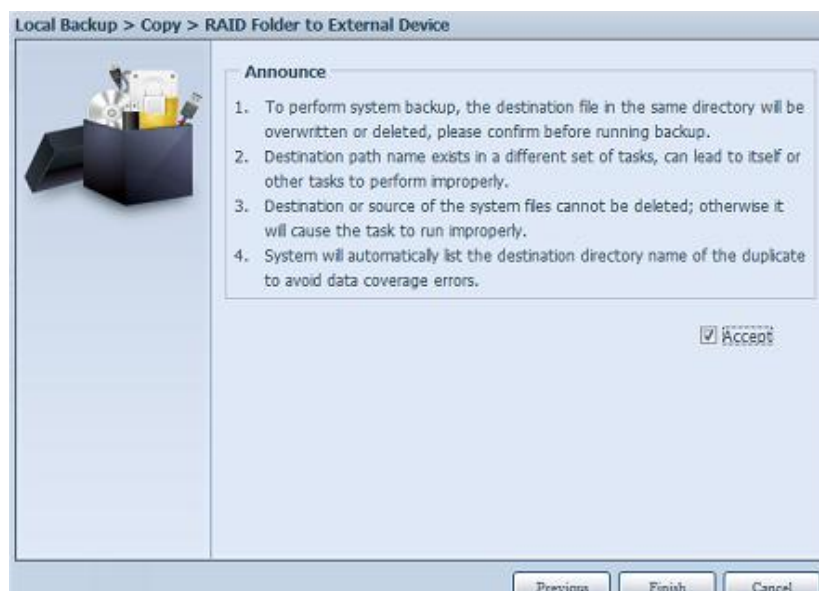

Now, you can see in the data guard task list that your created task is listed. The task status will say "Processing" until the "Stop" button is pressed.

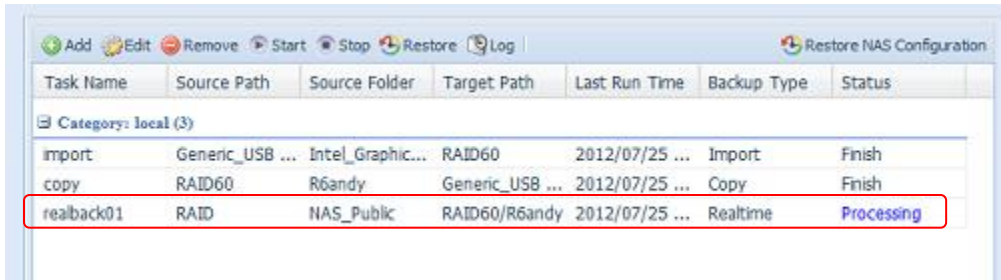

4. **Schedule Backup:** click on "Schedule Backup" and this screen will. 2 different choices can be selected from, folder to folder, folder to external device.

Let's use "Folder to External device" backup for our example. From the NAS volume RAID in the Source pane select the folder "NAS_Public", then in the target pane select the external USB disk folder "N10850".



Next, fill in the task name and related settings.

Schedule Backup	
Item	Description
Task Name	Input the task name, length limited to 4~12 characters.
Create Sub-folder	If you choose to create a sub-folder, then it will use the task name as folder name then copy the source under it. Or it will copy the source to the same level as the destination.
Sync Type	Select "Incremental" or "Synchronize".
Log Location	Select from the drop down list where the task log will be stored.
Enable Schedule	Click to enable. If it is not checked, the task won't start unless you select the associate task and click "Start" from the task list page.
Time	Specify the time for the backup to start.
Schedule	Can choose daily, weekly or monthly.

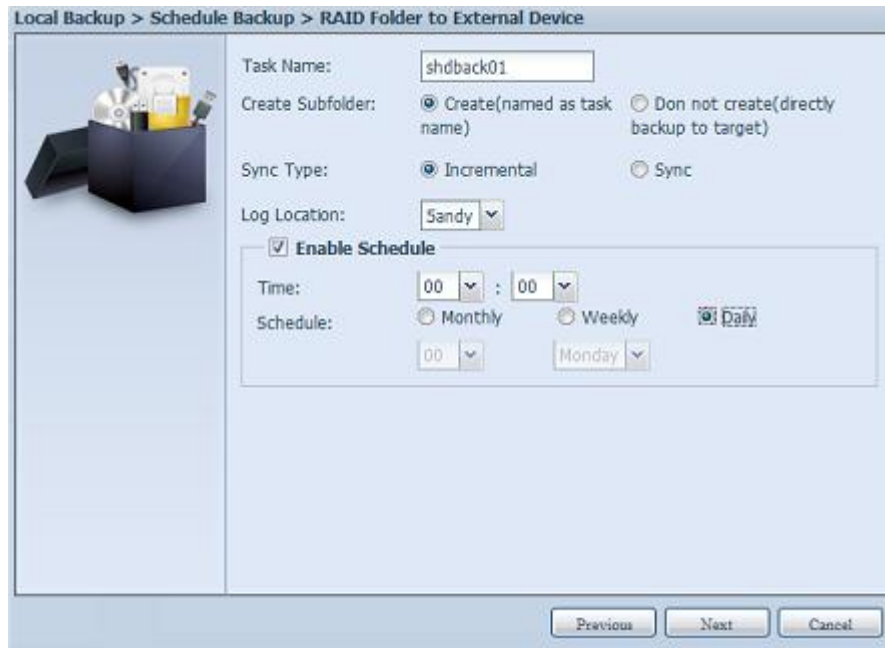

Read the notes and check the "Accept" box for confirmation.

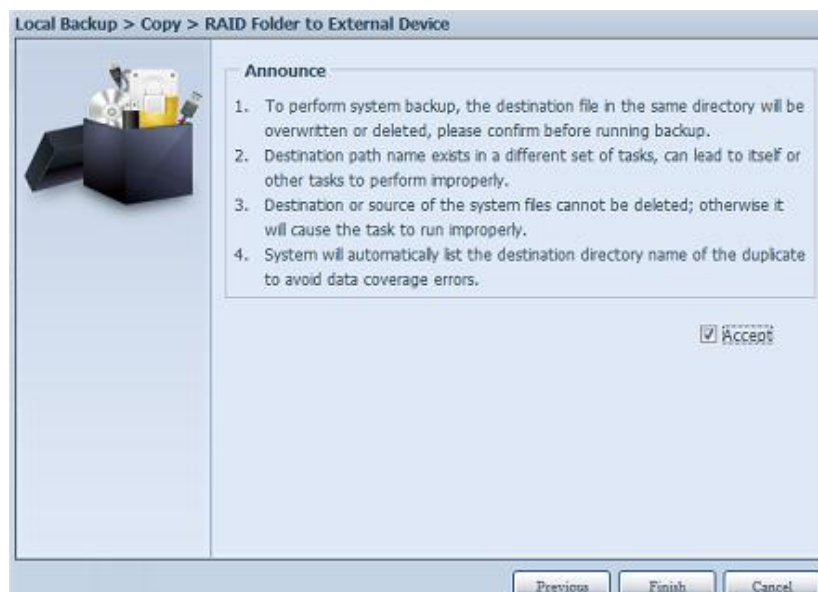

Now, you will see in the data guard task list that you have created a task.

Task Name	Source Path	Source Folder	Target Path	Last Run Time	Backup Type	Status
Category: local (4)						
import	Generic_USB ...	Intel_Graphic...	RAID60	2012/07/25 ...	Import	Finish
copy	RAID60	R6andy	Generic_USB ...	2012/07/25 ...	Copy	Finish
realback01	RAID	NAS_Public	RAID60/R6andy	2012/07/25 ...	Realtime	Processing
shdback01	RAID	NAS_Public	Generic_USB ...	2012/07/26 ...	Schedule	Finish

5. **iSCSI Backup:** click on "iSCSI Backup" and screen appear as below. It can be backup to two different storage pool, iSCSI to folder, iSCSI to external device.



Let's take example to have "iSCSI to Folder" backup, from existed iSCSI volume "iSCSI_iscsiv502" to volume RAID folder "andy_local".

The source pane listed "iSCSI_iscsiv502" and "iSCSI_iscsiv50" where are iscsi volume has existed in this system with name "iSCSI_+iscsi target volume name".

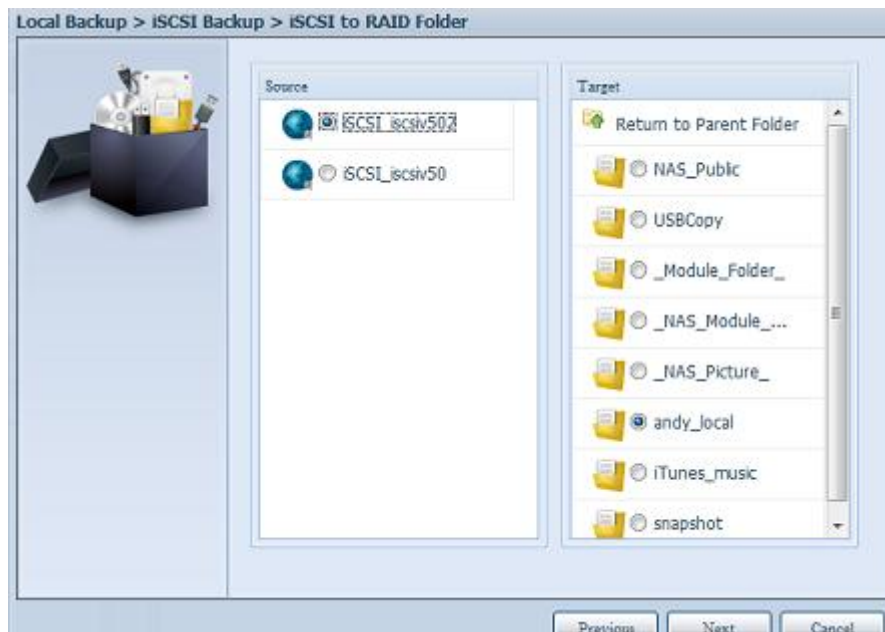

Next, provide the task name and where the task log will store.

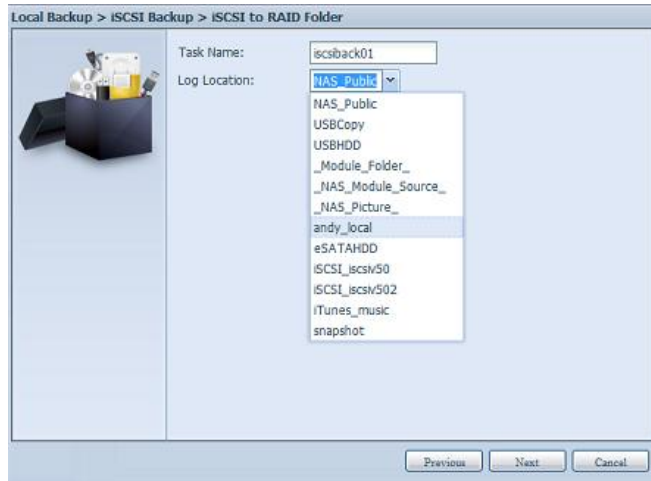

Reading the note and check on "Accept" for confirmation.

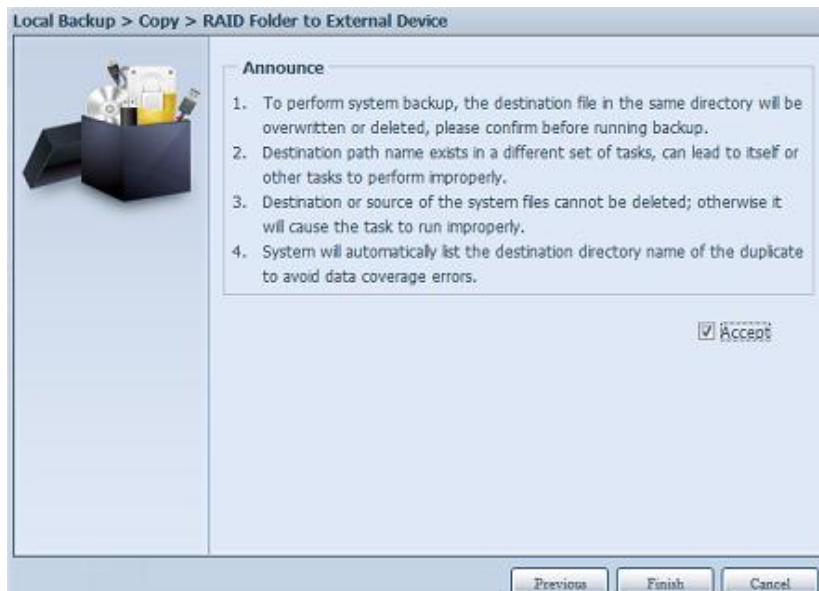

Now, from the data guard task list will have created task listed. To start the iSCSI volume backup, select the task and click "Start" from task bar.

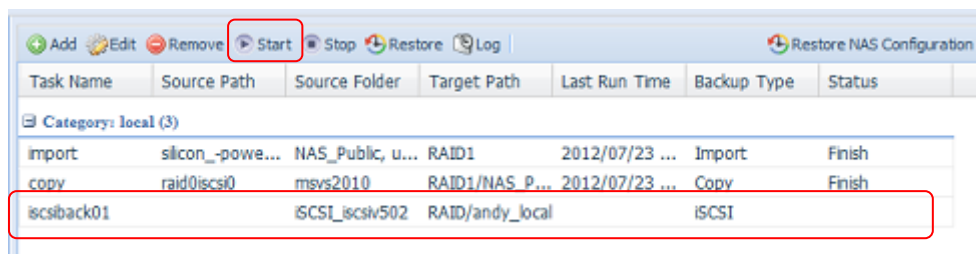

Once "Start" click, the associated iSCSI volume will not allow to I/O during backup processing. And the task status will change to 'Processing'.

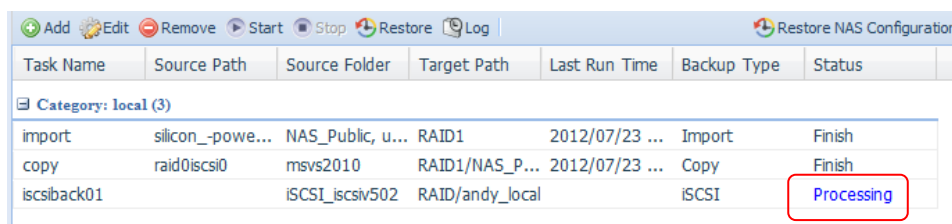

States change to "Finish" after task complete.

Task Name	Source Path	Source Folder	Target Path	Last Run Time	Backup Type	Status
Category: local (3)						
import	silicon_powe...	NAS_Public, u...	RAID1	2012/07/23 ...	Import	Finish
copy	raid0iscsi0	mvs2010	RAID1/NAS_P...	2012/07/23 ...	Copy	Finish
iscsiback01		ISCSI_iscsiv502	RAID/andy_local	2012/07/26 ...	iSCSI	Finish

From the RAID volume folder 'andy_local', it has backup iSCSI volume file stored. This backup iSCSI volume file is needed while it required import to storage. Next topic will describe about this.

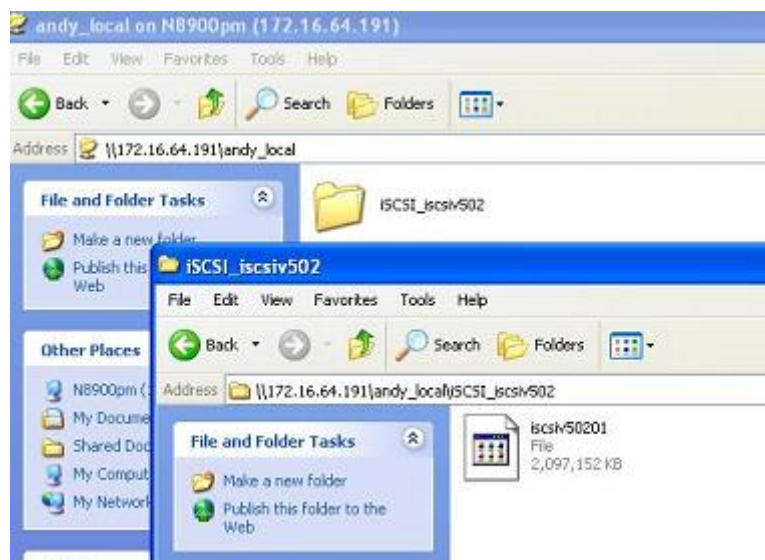

- iSCSI Import:** click on "iSCSI Import" and screen appear as below. It can be imported from two different storage pools, folder to iSCSI or external device to iSCSI. It is depend on where iSCSI volume has backup to.



Let's take example to import "RAID folder to iSCSI" which is the iSCSI volume we have backup earlier to RAID volume folder andy_local than import to volume RAID.

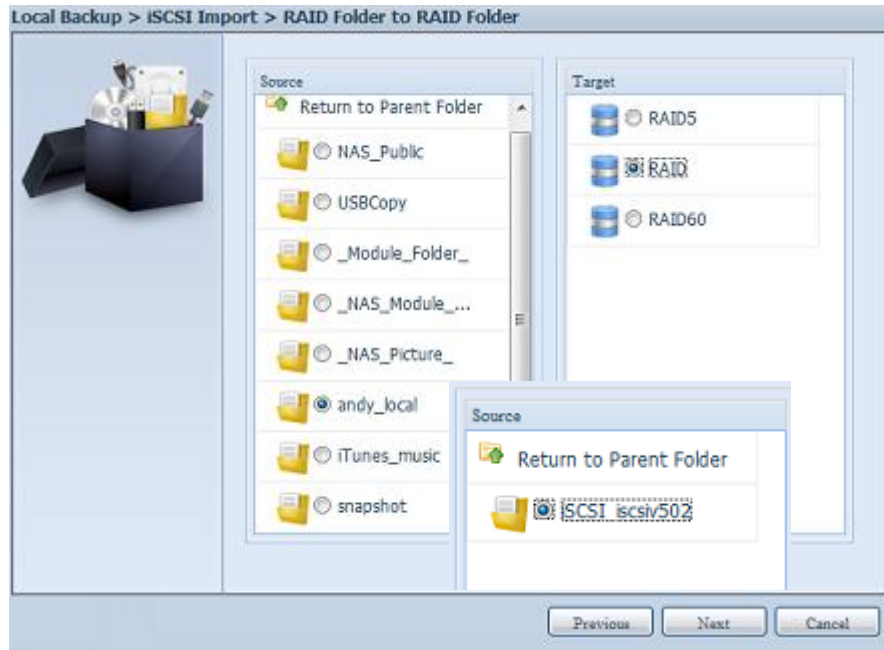

Next, provide where the task log will store.

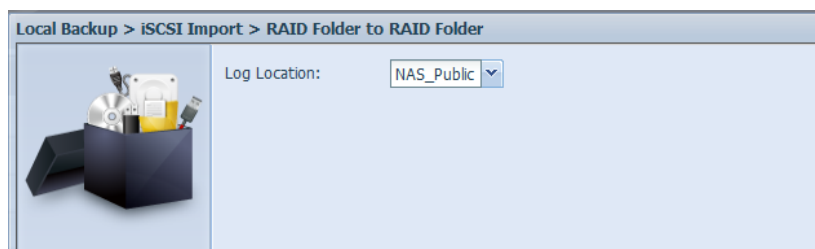

Reading the note and check on "Accept" for confirmation.

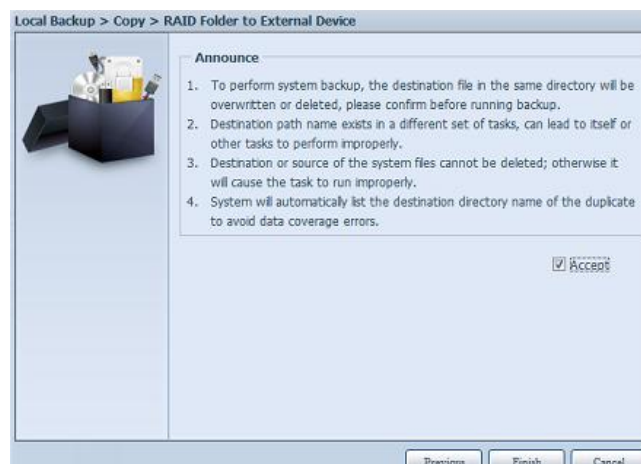

Now, from the data guard task list will have created task listed.

Task Name	Source Path	Source Folder	Target Path	Last Run Time	Backup Type	Status
Category: local (5)						
import	Generic_USB ...	Intel_Graphic...	RAID60	2012/07/25 ...	Import	Finish
copy	RAID60	R6andy	Generic_USB ...	2012/07/25 ...	Copy	Finish
realback01	RAID	NAS_Public	RAID60/R6andy	2012/07/26 ...	Realtime	Lose target
shdback01	RAID	NAS_Public	Generic_USB ...	2012/07/26 ...	Schedule	Finish
import_iscsi	RAID/andy_local	iSCSI_iscsv502	RAID	2012/07/26 ...	iSCSI Import	Finish

USB Copy

The USB Copy function using the USB copy button or front panel LCM/OLED of system used to only offer one-way transfers (i.e. only from the USB drive to the designated NAS folder). Now numerous options are available, such as: Disabled, bi-directional, and scheduled.

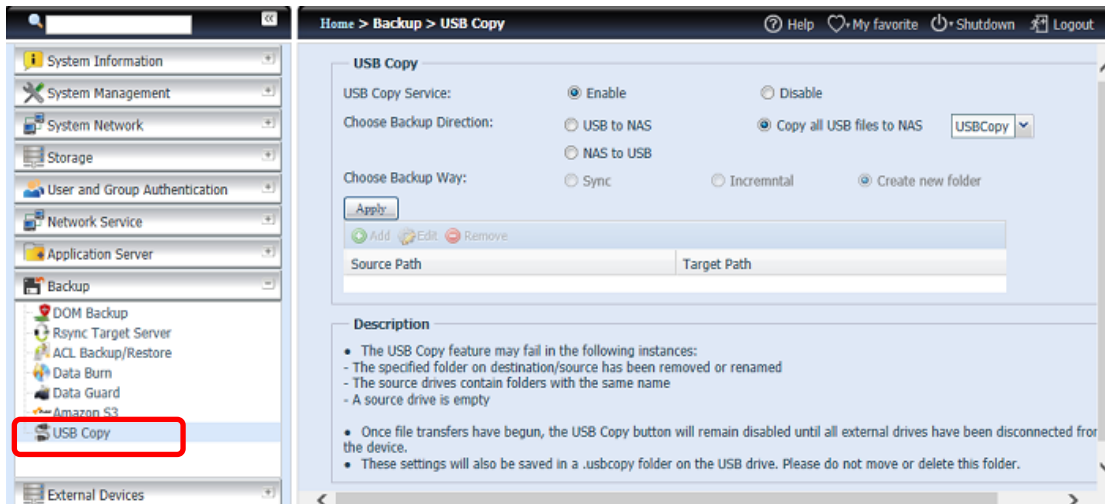

Disable USB Copy

Simply select "Disable" for the USB Copy Service option and the USB Copy button or LCM/OLED USB Copy item will become inactive.

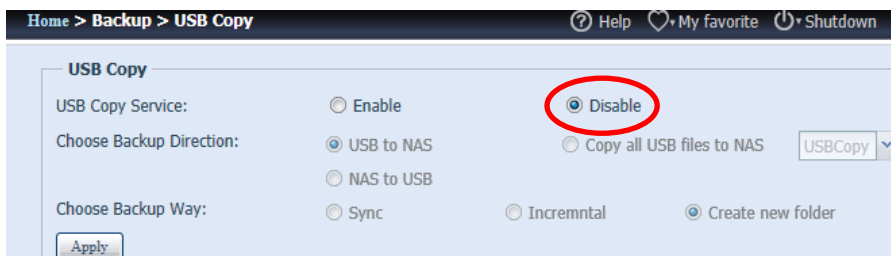

Using USB Copy

Enable the USB Copy service and select one of the 3 options available: "USB to NAS", "NAS to USB", and "Copy all USB files to NAS".

If select "USB to NAS" or "NAS to NAS", you will also need to set up the type of backup desired.

USB Copy Service Transfer Options	
Item	Description
Sync	Makes your source match your target completely; deleting and adding files on your target as they are deleted and added on your source.
Incremental	Makes your source match your target and keep all old files; adding files on your target as they are added on your source, but NOT deleting files on your target as they are deleted on your source.
Create New Folder	Create new folder on target based on the task's "Date+Time".
Apply	Press Apply to confirm the settings.

Now, add the task for the USB Copy service you have selected (for "USB to NAS" or "NAS to USB").

Click on "Add" and select "Source Path" and "Target Path" from the drop-down list.

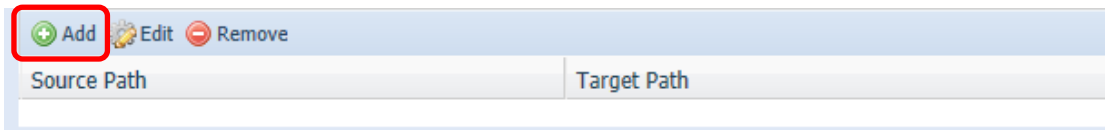

Add Source:

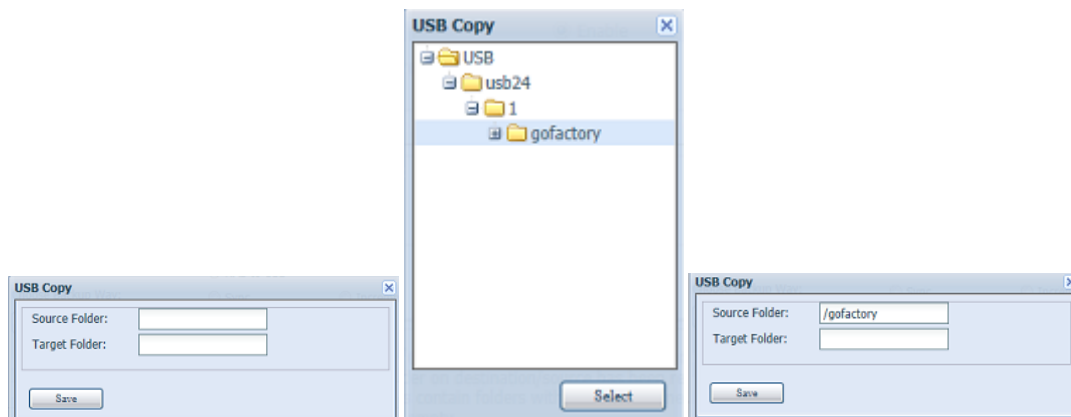

Add Target:

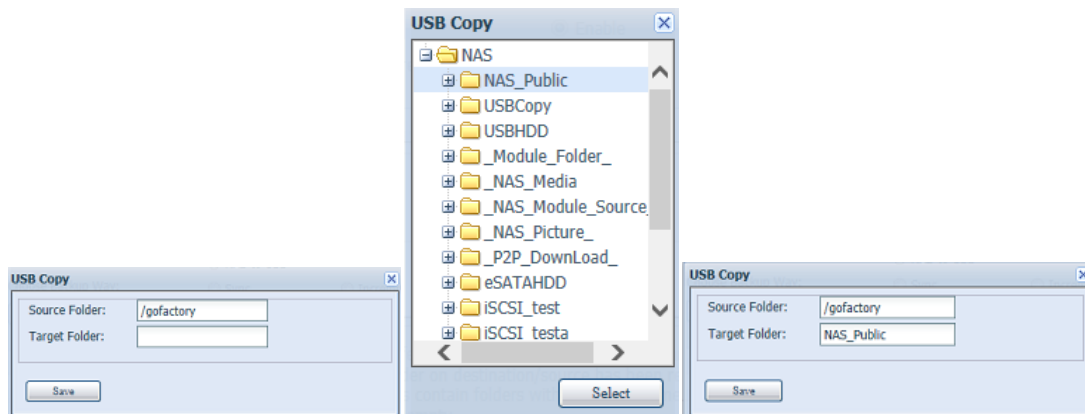

Save the completed task:

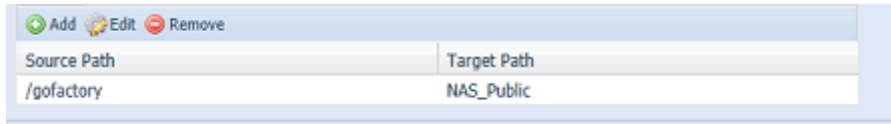

To "Edit" or "Remove" a USB Copy task, select the task item and click on the associated function:

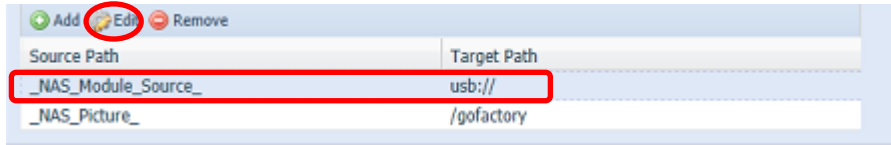

If you select "Copy all USB files to NAS", then please choose the target path from the drop-down list. All files and folders on the USB device will be copied over to the NAS.

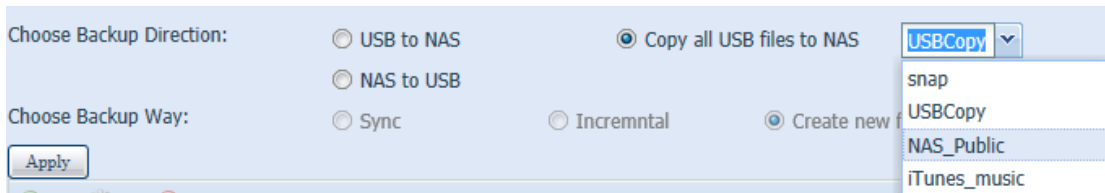

NOTE

If "Sync" mode has been selected, the target-side redundant folders/files will be deleted after a comparison has been conducted of the source.

NOTE

Once the USB Copy service has completed, the USB device will un-mount from system. To start another task, please re-insert the USB device.

Volume Expansion Management

The user guide please refers to URL below.

http://www.thecus.com/download/manual/AllinOne_64bit/Volume_Expansion_v1.0.pdf

Thecus Backup Utility

The Thecus Backup Utility is on your Installation CD. When you click on the CD, the Backup Utility will be installed under **Program Groups > Thecus > Thecus Backup Utility**. If it is not installed, you can copy the file (**Thecus Backup Utility.exe**) to a convenient location on your hard disk and double click to execute it.



NOTE

If you can not find Thecus Backup Utility on your CD, please download it from the Thecus website (<http://www.thecus.com>).

When you execute this utility for the first time, it will ask you to create a DB file. Click **Yes**.

1. Click **Add** to create a Backup task. The **Add New Task** dialog box will appear.

Add New Task	
Item	Description
Task	Specifies a name for the current task.
Source	Click to specify the source folder/file location.
Incremental	Click to specify whether the backup will be incremental. If unchecked, the backup will be a full backup.
Destination	Click to specify the destination folder/file location.
Excluded extensions	Files with these file name extensions will be skipped and not backed up to the destination.
Comments	If you wish, enter a comment here for your records.

2. To schedule the task to run at regular intervals, click on the **Schedule** icon for that task. You can schedule the task to run **Monthly** or **Weekly**.
3. To check the log for that task, click on the **Log** icon for that task.

NOTE

Thecus Backup Utility also supports MAC OS X. Just copy the Thecus Backup Utility.dmg to your MAC OS X machine and double click to execute it.

Windows XP Data Backup

If you use Windows XP Professional, you can also use the Windows Backup Utility (Ntbackup.exe) to back up your files.

If you use Windows XP Home Edition, follow these steps to install the utility:

1. Insert the Windows XP CD into a drive and double-click the **CD** icon in **My Computer**.

2. When the Welcome to Microsoft Windows XP screen appears, click **Perform Additional Tasks**.
3. Click **Browse this CD**.
4. In Windows Explorer, navigate to **ValueAdd > Msft > Ntbackup**.
5. Double-click **Ntbackup.msi** to install the backup utility.

Once installed, you can use the Windows Backup Utility by following the steps below:

1. Click **Start**, and point to **All Programs > Accessories > System Tools > Backup** to start the wizard.
2. Click **Next** to skip past the opening page. Choose **Backup files and settings** from the second page, and then click **Next**.
3. Select which option you want to back up.
4. Click **Next** and in the Backup Type, Destination, and Name page, specify a backup location using the **Browse** button.
5. Find and select the drive that specifies your Thecus IP storage as your backup destination and click **Next**.
6. Click **Next** to display the wizard's final page and click **Finish** to start backing up.

Apple OS X Backup Utilities

Mac OS X does not include any backup software. However, there are a number of backup solutions available for the Mac OS X, including: [iBackup](#), [Psyncx](#), [iMSafe](#), [Rsyncx](#), [Folder Synchronizer X](#), [Tri-BACKUP](#), [Impression](#), [Intego Personal Backup](#), [SilverKeeper](#), and Apple's dotMac Backup utility to name just a few. To find even more freeware and shareware backup utilities to choose from, go to [VersionTracker](#) or [MacUpdate](#) and search on "backup".

External Devices

The Thecus IP storage supports printer server and UPS via USB interface. The integrated Print Server allows you to share a single USB printer with all users on the network. For the UPS, Thecus IP storage support via USB, Series and Network interface. The following section shows you how.

Printers

From the **External Devices** menu, choose the **Printer** item, and the **Printer Information** screen appears. This screen provides the following information about the USB printer connected to the USB port.

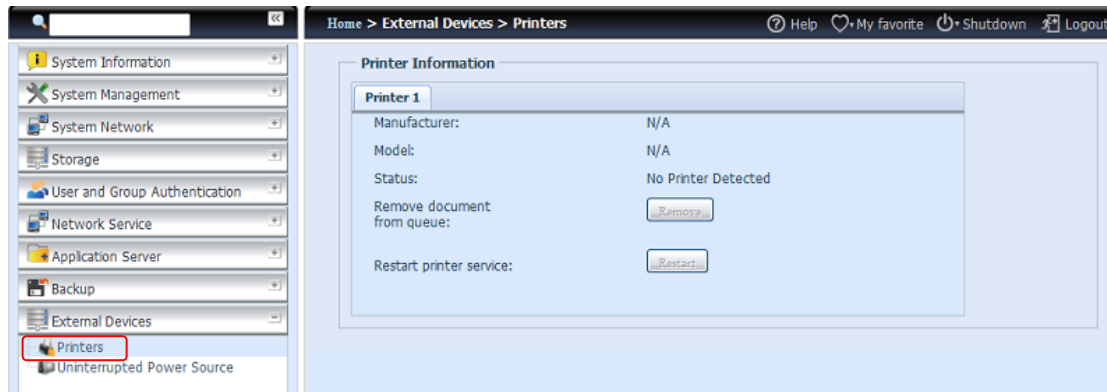

Printer Information	
Item	Description
Manufacturer	Displays the name of the USB printer manufacturer.
Model	Displays the model of the USB printer.
Status	Displays the status of the USB printer.
Remove document from Queue	Click to remove all documents from printer queue
Restart Printer service	Click to restart printer service

If a corrupt print job is sent to a printer, printing may suddenly fail. If your print jobs seem to be locked up, pressing the **Remove All Documents** button to clear the print queue may resolve the issue.

You can configure Thecus IP storage to act as a printer server. That way, all PCs connected to the network can utilize the same printer.

Windows XP SP2

To set up the Printer Server in Windows XP SP2, follow the steps below:

1. Connect the USB printer to one of the USB ports (preferably the rear USB ports; front USB ports can be used for external HDD enclosures).
2. Go to **Start > Printers and Faxes**.
3. Click on **File > Add Printer**.
4. The **Add Printer Wizard** appears on your screen. Click **Next**.
5. Select the **"A network printer, or a printer attached to another computer"** option.
6. Select **"Connect to a printer on the Internet or on a home or office network"**, and enter **"http://Thecus IP storage IP_ADDRESS:631/printers/usb-printer"** into the URL field.
7. Your Windows system will ask you to install drivers for your printer. Select the correct driver for your printer.
8. Your Windows system will ask you if you want to set this printer as "Default Printer". Select **Yes** and all your print jobs will be submitted to this printer by default. Click **Next**.

9. Click **Finish**.

NOTE

- Note that if a multi-function (all-in-one) printer is attached to the Thecus IP Storage, usually only the printing and fax functions will work. Other features, such as scanning, will probably not function.

Windows Vista

To set up the Printer Server in Windows Vista, follow the steps below:

1. Open **Printer Folder** from the **Control Panel**.

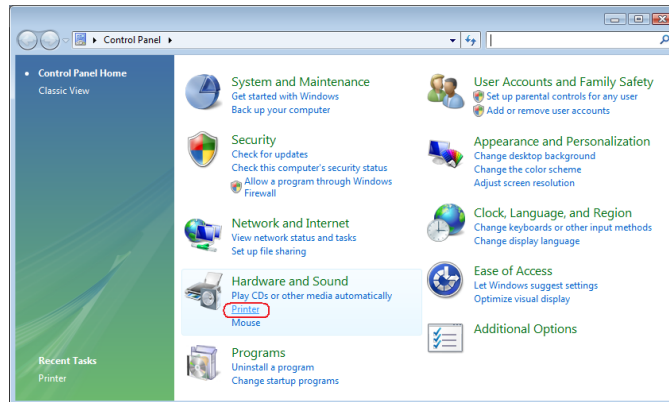

2. Click the right mouse button in anywhere on the **Printers** folder and then select **Add Printer**.

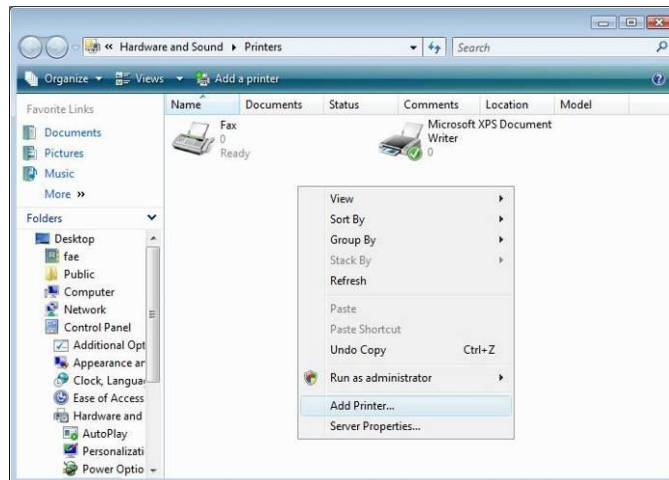

3. Select **Add a network, wireless or Bluetooth printer**.

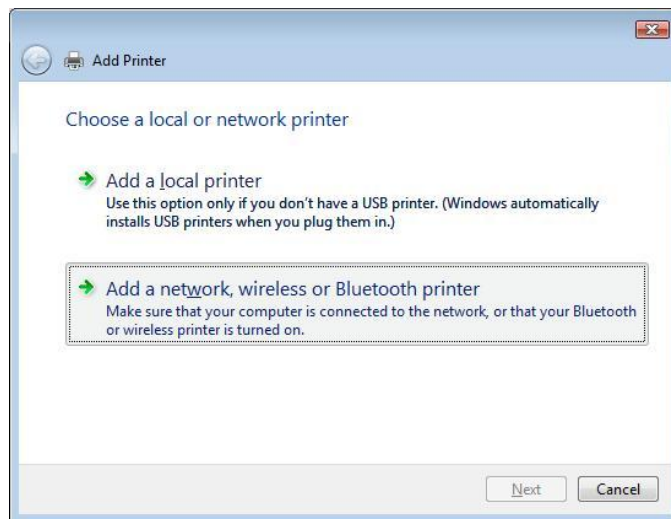

4. Select **The printer that I want isn't listed**.

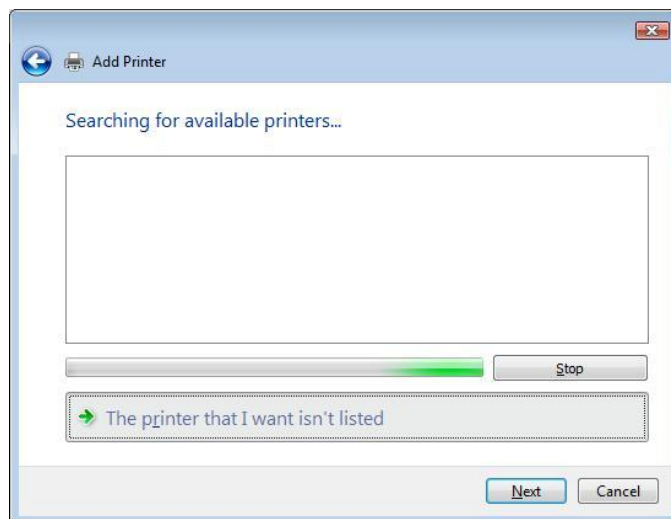

You can press **The printer that I want isn't listed** to go into next page without waiting for **Searching for available printers** to finish.

5. Click **Select a shared printer by name**.

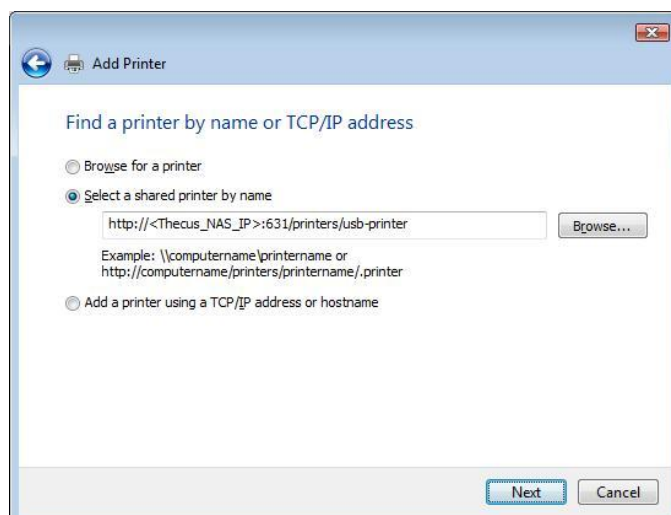

Type `http://<Thecus_NAS>:631/printers/usb-printer` in the box, where `<Thecus_NAS_IP>` is the IP address of Thecus IP storage. Click **Next**.

6. Select or install a printer and then press **OK**.

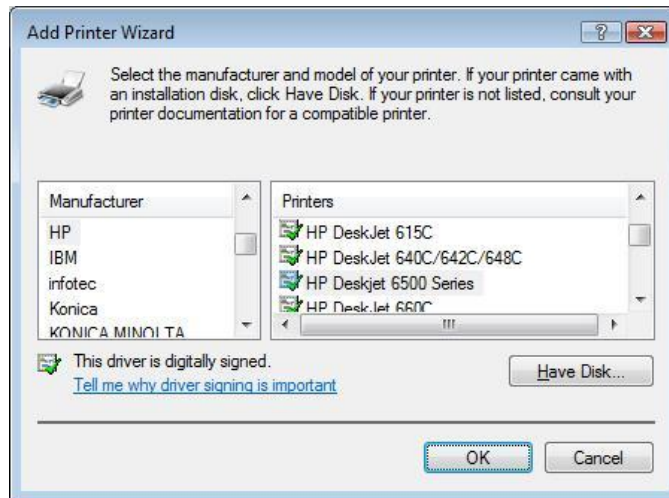

7. Windows will attempt to connect to the printer.

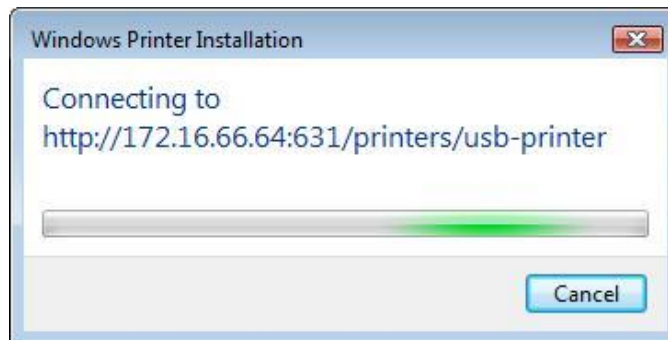

8. You can choose to set this printer as the default printer by checking the **Set as the default printer** box. Click **Next** to continue.

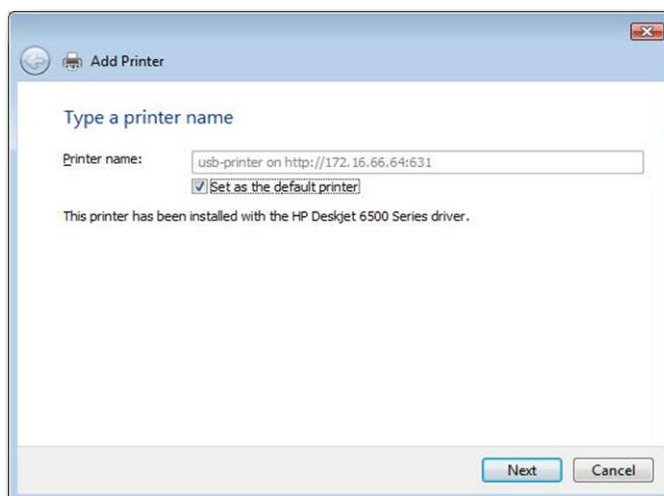

9. Done! Click **Finish**.

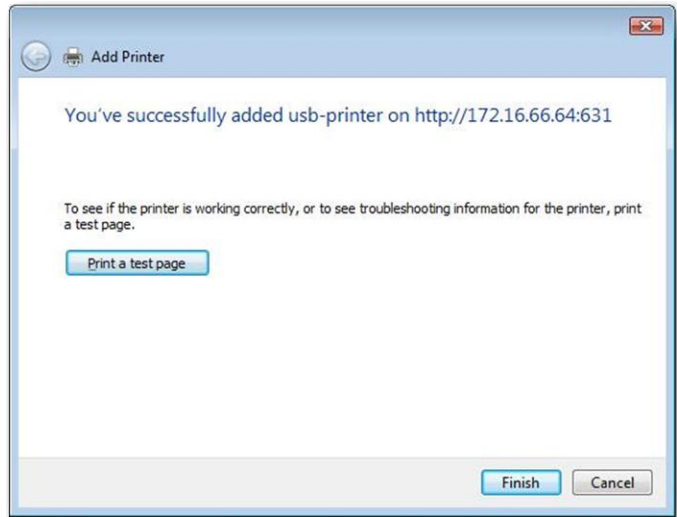

Uninterrupted Power Source

From the **External Devices** menu, choose the **Uninterrupted Power Source** item and the **UPS Setting** screen appears. Make any changes you wish, and press **Apply** to confirm changes.

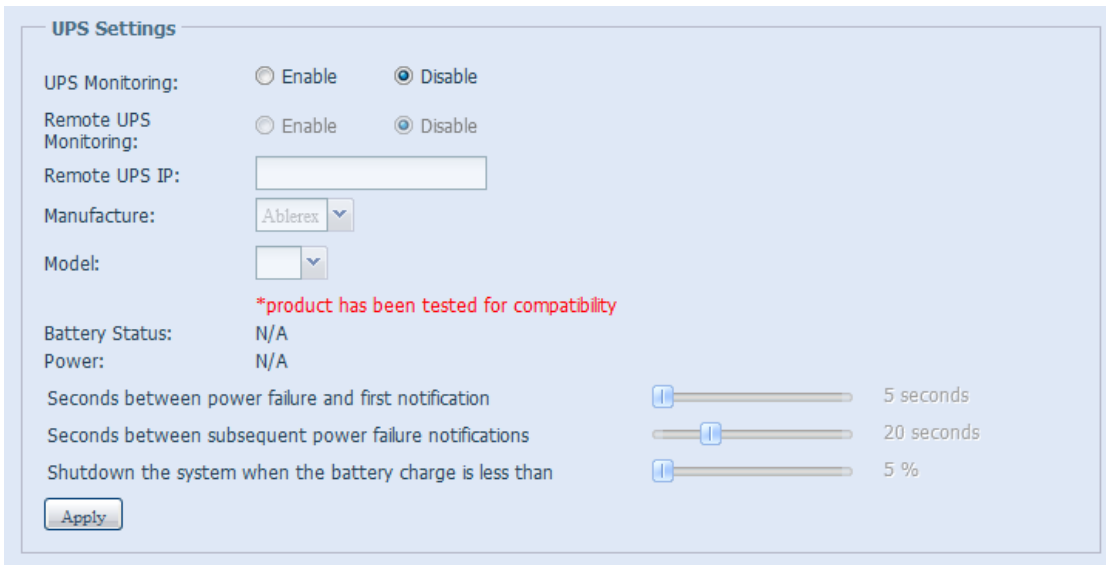

See the following table for a detailed description of each item.

UPS Setting	
Item	Description
UPS Monitoring	Enable or disable UPS monitoring.
Remote UPS Monitoring	Enable or disable Remote UPS monitoring.
Remote UPS IP	Input the IP address of the NAS that the UPS device is connected to via USB or RS232. Input the IP address of your network UPS.
Manufacturer	Choose the UPS manufacturer from the dropdowns.
Model	Choose the UPS model number from the dropdowns.
Battery Status	Current status of the UPS battery

Power	Current status of the power being supplied to the UPS
Seconds between power failure and first notification	Delay between power failure and first notification in seconds.
Seconds between subsequent power failure notifications	Delay between subsequent notifications in seconds.
Shutdown the system when the battery charge is less than	Amount of UPS battery remaining before system should auto-shutdown.
Apply	Press Apply to save your changes.

Chapter 5: Tips and Tricks

USB and eSATA Storage Expansion

The Thecus IP storage supports external USB hard disks through its USB ports. Once a USB hard disk is successfully mounted, the entire volume will be linked automatically to the default USB HDD folder. The Thecus IP storage supports USB external storage devices. All file names on the USB disk volume are case sensitive.

The Thecus IP storage also supports eSATA hard disks with its eSATA port.

Before attaching an eSATA or USB disk drive to Thecus IP storage, you have to partition and format it on a desktop computer or a notebook first. The attached device will be located at `\\192.168.1.100\usbhdd\sd(x)1` where `192.168.1.100` means the IP address of Thecus IP storage and `sd(x)1` stands for the first partition on the eSATA or USB disk drive.

Remote Administration

You can set up your Thecus IP storage for remote administration. With remote administration, you can access your Thecus IP storage over the Internet, even if your Thecus IP storage is behind a router. This is especially useful if you are traveling and suddenly need a file from your Thecus IP storage.

Setting up remote administration is a three-part process, and will require the following equipment:

- Thecus IP storage device
- Cable / DSL Router with Dynamic DNS support
- Home PC
- Internet Connection

NOTE

Router setup will differ slightly depending on router used. For this example, we will use the Asus WL500g because it has support for Dynamic DNS. Contact your router hardware vendor for setup help.

Part I - Setup a DynDNS Account

1. Go to <http://www.dyndns.org> from your home PC.
2. Click on the **Sign Up Now** link.
3. Check the Check boxes, select a user name (i.e.: N12000), enter your email address (i.e.: xxx@example.com), check **Enable Wildcard**, and create a password (i.e.: xxxx).
4. Wait for an email from www.dyndns.org.
5. Open the email and click on the link to activate your account

Part II - Enable DDNS on the Router

1. Go to the router setup screen and select **IP Config > Miscellaneous DDNS Setting** from your Home PC.
2. Click on **Yes** for **Enable the DDNS Client?**
3. Select www.dyndns.org.
4. Go to router setup screen, and enter the following information:
 - a. User Name or E-mail Address: **xxx@example.com**
 - b. Password or DDNS Key: **xxxx**
 - c. Host Name: **www.N12000.dyndns.org**
 - d. Enable wildcard? Select **Yes**
 - e. Update Manually: Click **Update**

Part III - Setting up Virtual Servers (HTTPS)

1. Navigate to **NAT Setting > Virtual Server**.
2. For **Enable Virtual Server?**, select **Yes**
3. Setup the HTTPS Server
 - a. **Well-Known Applications:** Select **User Defined**
 - b. **Local IP:** Enter **192.168.1.100**
 - c. **Port Range:** **443** (the default HTTPS port setting on the Thecus IP storage)
 - d. **Protocol:** select **TCP**
 - e. Click **Add**.
 - f. Click **Apply**.
4. Test the HTTPS connection from another computer on the Internet
 - a. From a remote computer, open your browser and enter <https://www.N12000.dyndns.org>
 - b. You should see the login page of Thecus IP storage.

Firewall Software Configuration

If you are using a software firewall (i.e. Norton Internet Security) and are having trouble connecting to Thecus IP storage, you can try the following steps:

1. Double click the **NIS** icon on system tray, and then configure the **Personal Firewall**.
2. On the **Programs** page, find the **SetupWizard.exe** and change its permission to "Permit All". If it's not in the program list, use the **Add** or **Program Scan** buttons to find it.
3. On the **Networking** page, manually add Thecus IP storage IP address (i.e. 192.168.1.100) to the **Trusted** list.

Replacing Damaged Hard Drives

If you are using RAID 1, RAID 5, RAID 6, RAID 50 or RAID 60 you can easily replace a damaged hard drive in the Thecus IP storage while keeping your data secure with the system's automatic data recovery.

Hard Drive Damage

When a hard drive is damaged and data in the RAID volume is corrupted, the system OLED will display a warning message and the system will beep.

Replacing a Hard Drive

To replace a hard disk drive in the Thecus IP storage:

1. Remove the tray with the damaged hard disk.
2. Unscrew the damaged hard disk and remove it from the tray.
3. Slide a new hard disk into the tray and fasten the screws.
4. Insert the hard disk tray back into the Thecus IP storage until it snaps into place. You can also lock it with a key if desired.
5. The LED will blink green when the HDD is accessed.

RAID Auto-Rebuild

When using RAID 1, 5, 6, 10, 50 or 60 on the Thecus IP storage, you can use the auto-rebuild function when an error is detected.

1. When a hard disk fails the system beeps and/or an email notification is sent to the specified receivers.
2. Check the OLED to see which disk has failed.
3. Follow the steps mentioned above to replace the failed hard disk.
4. The system automatically recognizes the new hard disk and starts the auto-rebuild sequence to resume its status before the hard disk crash.

Chapter 6: Troubleshooting

Forgot My Network IP Address

If you forget your network IP address and have no physical access to the system, you can find out the IP address by either looking directly onto the Thecus IP storage OLED panel, or by using the setup wizard to retrieve the IP of your Thecus IP storage.

1. Start the Setup Wizard, and it will automatically detect all Thecus IP storage products on your network.
2. You should be able to find the IP address of the Thecus IP storage which you have forgotten in the **Device Discovery** screen.

Can't Map a Network Drive in Windows XP

You may have problems mapping a network drive under the following conditions:

1. The network folder is currently mapped using a different user name and password. To connect using a different user name and password, first disconnect any existing mappings to this network share.
2. The mapped network drive could not be created because the following error has occurred: **Multiple connections to a server or shared resource by the same user, using more than one user name, are not allowed.** Disconnect all previous connections to the server or shared resource and try again.

To check out existing network connections, type `net use` under the DOS prompt. You may refer the URL below for more network mapping information.

http://esupport.thecus.com/support/index.php?_m=downloads&_a=viewdownload&downloaditemid=57&nav=0

Restoring Factory Defaults

From the **System** menu, choose the **Factory Default** item and the **Reset to Factory Default** screen appears. Press **Apply** to reset Thecus IP storage factory default settings.

WARNING

Resetting to factory defaults will not erase the data stored in the hard disks, but WILL revert all the settings to the factory default values.

Problems with Time and Date Settings

The administrator is able to select an NTP Server to keep Thecus IP storage time synchronized. However, if Thecus IP storage cannot access the Internet, you may encounter a problem when setting the Time and Time Zone. If this happens:

1. Login to the Web Administration Interface.
2. Navigate to **System Management>Time**.
3. Under **NTP Server**, select **No**.
4. Set the **Date**, **Time**, and **Time Zone**.
5. Click **Apply**.

In addition, if the Thecus IP storage is able to access the Internet and you want to keep the NTP Server clock.isc.org by default, please make sure the DNS Server is correctly entered, thereby allowing the NTP Server name to correctly resolve. (See **System Network > WAN/LAN1 > DNS Server**)

Dual DOM Supports for Dual Protection (N12000 series/N16000 series/N8900 series/N12850/N16850 only)

The most advance and useful feature on the Thecus IP storage (depend on models) is the implemented Dual DOM. Under normal circumstances, there is no need to have this feature involved. But some unpredictable problems like power cut or human error can occur by accident, especially during system booting stage; the Dual Dom will become the best feature to prevent system down time. Practically while it happened, system will try to recover the DOM 1 from DOM 2 first. If it is unachievable then the system can boot from DOM 2. And all of these procedures can be operated through the OLED.

NOTE

The DOM1 in Dual DOM is by default the master DOM and FW updates will only apply to DOM1. DOM2 is 'Read only".
If anything happened and the DOM1 is recovered from DOM2, the FW version will be the one of the DOM2. Therefore, it may need to be upgraded to the version of DOM1.
If DOM1 can not be recovered from DOM2, the system will boot up from DOM2. The original configuration of DOM1 may need to be setup again with DOM2 operations.

Appendix A: Customer Support

If your Thecus IP storage is not working properly, we encourage you to check out **Chapter 6: Troubleshooting**, located in this manual. You can also try to ensure that you are using the latest firmware version for your Thecus IP storage. Thecus is committed to providing free firmware upgrades to our customers. Our newest firmware is available on our Download Center:

http://www.thecus.com/sp_download.php

If you are still experiencing problems with your Thecus IP storage, or require a Return Merchandise Authorization (RMA), feel free to contact technical support via our Technical Support Website:

http://www.thecus.com/sp_tech.php

Customers in the US should send all technical support enquiries to the US contact window included in the following web page:

http://www.thecus.com/sp_tech.php

For Sales Information you can e-mail us at:

sales@thecus.com

Thank you for choosing Thecus!

Appendix B: RAID Basics

Overview

A Redundant Array of Independent Disks (RAID) is an array of several hard disks that provide data security and high performance. A RAID system accesses several hard disks simultaneously, which improves I/O performance over a single hard disk. Data security is enhanced by a RAID, since data loss due to a hard disk failure is minimized by regenerating redundant data from the other RAID hard disks.

Benefits

RAID improves I/O performance, and increases data security through fault tolerance and redundant data storage.

Improved Performance

RAID provides access to several hard disk drives simultaneously, which greatly increases I/O performance.

Data Security

Hard disk drive failure unfortunately is a common occurrence. A RAID helps prevent against the loss of data due to hard disk failure. A RAID offers additional hard disk drives that can avert data loss from a hard disk drive failure. If a hard drive fails, the RAID volume can regenerate data from the data and parity stored on its other hard disk drives.

RAID Levels

The Thecus IP storage supports standard RAID levels 0, 1, 5, 6, 10, 50, 60 and JBOD. You choose a RAID level when you create a system volume. The factors for selecting a RAID level are:

- Your requirements for performance
- Your need for data security
- Number of hard disk drives in the system, capacity of hard disk drives in the system

The following is a description of each RAID level:

RAID 0

RAID 0 is best suited for applications that need high bandwidth but do not require a high level of data security. The RAID 0 level provides the best performance of all the RAID levels, but it does not provide data redundancy.

RAID 0 uses disk striping and breaking up data into blocks to write across all hard drives in the volume. The system can then use multiple hard drives for faster read and write. The stripe size parameter that was set when the RAID was created determines the size of each block. No parity calculations complicate the write operation.

RAID 1

RAID 1 mirrors all data from one hard disk drive to a second one hard disk drive, thus providing complete data redundancy. However, the cost of data storage capacity is doubled.

This is excellent for complete data security.

RAID 5

RAID 5 offers data security and it is best suited for networks that perform many small I/O transactions at the same time, as well as applications that require data security such as office automation and online customer service. Use it also for applications with high read requests but low write requests.

RAID 5 includes disk striping at the byte level and parity information is written to several hard disk drives. If a hard disk fails the system uses parity stored on each of the other hard disks to recreate all missing information.

RAID 6

RAID 6 is essentially an extension of RAID level 5 which allows for additional fault tolerance by using a second independent distributed parity scheme (dual parity) Data is striped on a block level across a set of drives, just like in RAID 5, and a second set of parity is calculated and written across all the drives; RAID 6 provides for an extremely high data fault tolerance and can sustain two simultaneous drive failures.

This is a perfect solution for mission critical applications.

RAID 10

RAID 10 is implemented as a striped array whose segments are RAID 1 arrays. RAID 10 has the same fault tolerance as RAID level 1. RAID 10 has the same overhead for fault-tolerance as mirroring alone. High I/O rates are achieved by striping RAID 1 segments. Under certain circumstances, RAID 10 array can sustain up to 2 simultaneous drive failures

Excellent solution for applications that would have otherwise gone with RAID 1 but need an additional performance boost.

RAID 50

A RAID 50 combines the straight block-level striping of RAID 0 with the distributed parity of RAID 5. This is a RAID 0 array striped across RAID 5 elements. It requires at least 6 drives.

RAID 60

A RAID 60 combines the straight block-level striping of RAID 0 with the distributed double parity of RAID 6. That is, a RAID 0 array striped across RAID 6 elements. It requires at least 8 disks.

JBOD

Although a concatenation of disks (also called JBOD, or "Just a Bunch of Disks") is not one of the numbered RAID levels, it is a popular method for combining multiple physical disk drives into a single virtual one. As the name implies, disks are merely concatenated together, end to beginning, so they appear to be a single large disk.

As the data on JBOD is not protected, one drive failure could result total data loss.

Stripe Size

The length of the data segments being written across multiple hard disks. Data is written in stripes across the multiple hard disks of a RAID. Since multiple disks are accessed at the same time, disk striping enhances performance. The stripes can vary in size.

Disk Usage

When all disks are of the same size, and used in RAID, Thecus IP storage disk usage percentage is listed below:

RAID Level	Percentage Used
RAID 0	100%
RAID 1	$1/n \times 100\%$
RAID 5	$(n-1)/n \times 100\%$
RAID 6	$(n-2)/n \times 100\%$
RAID 10	50%
RAID 50	$(n-1)/n \times 100\%$
RAID 60	$(n-2)/n \times 100\%$
JBOD	100%

n : HDD number

Appendix C: How to open the top cover

N8900 series:

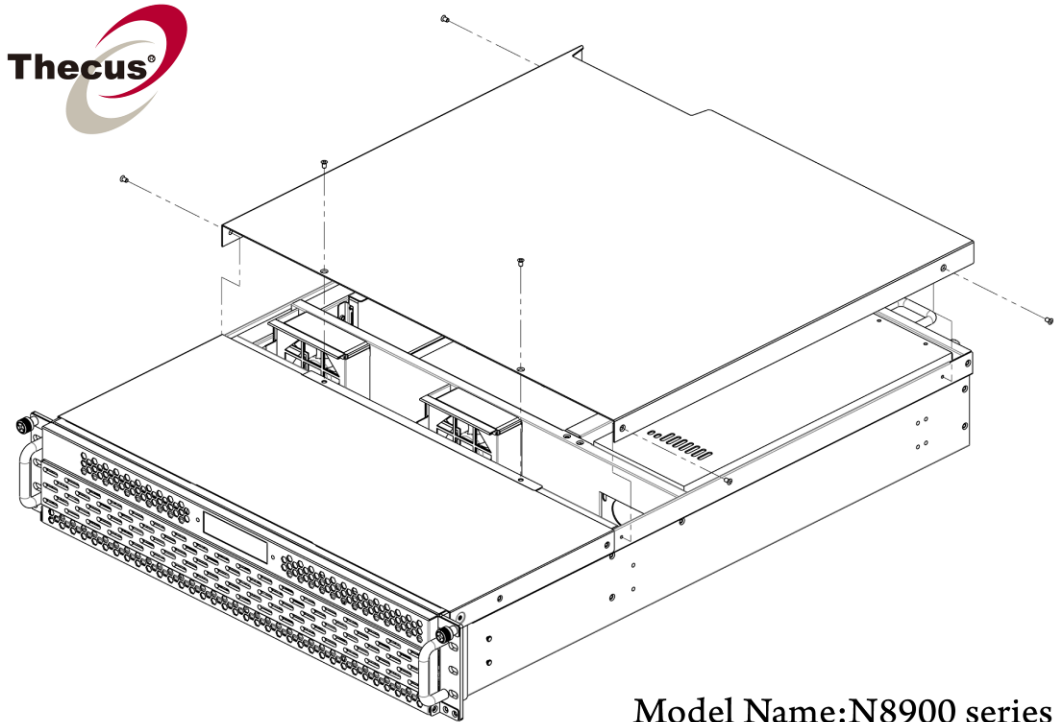

N12000 series/N12850:

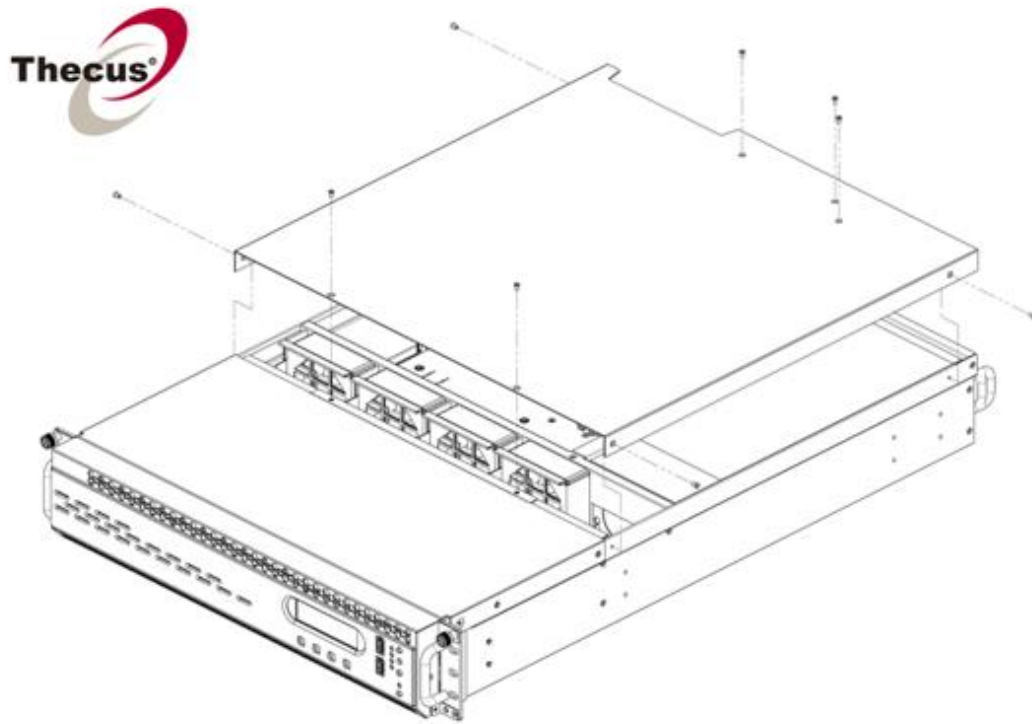

N16000 series/N16850:

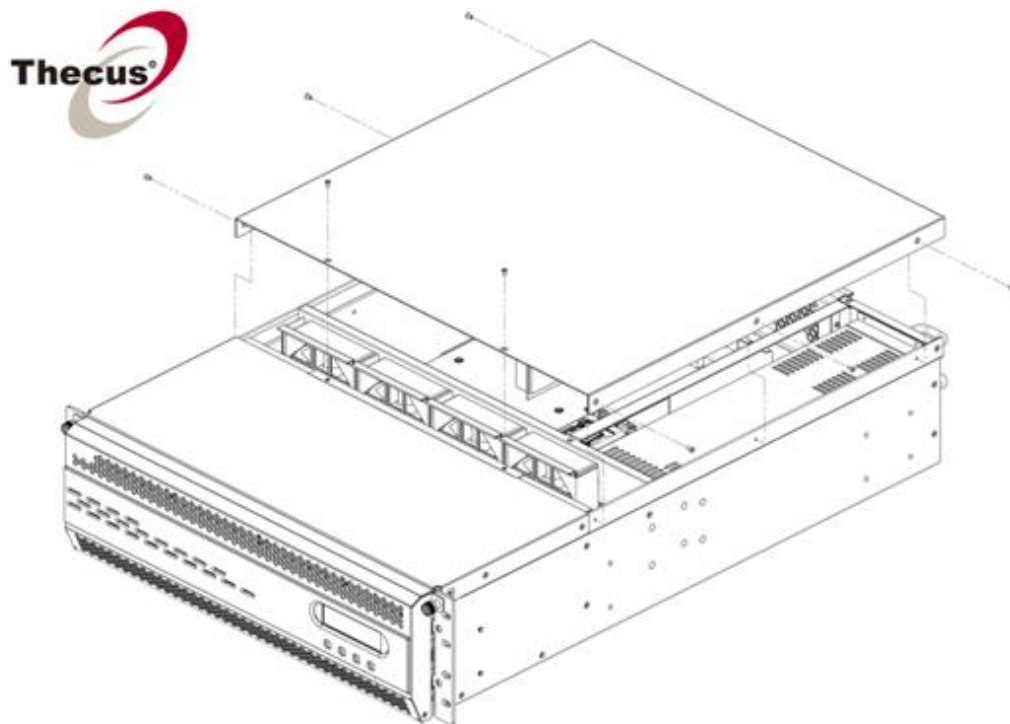

Appendix D: Active Directory Basics

Overview

With Windows 2000, Microsoft introduced Active Directory (ADS), which is a large database/information store. Prior to Active Directory the Windows OS could not store additional information in its domain database. Active Directory also solved the problem of locating resources; which previously relied on Network Neighborhood, and was slow. Managing users and groups were among other issues Active Directory solved.

What is Active Directory?

Active Directory was built as a scalable, extensible directory service that was designed to meet corporate needs. A repository for storing user information, accounts, passwords, printers, computers, network information and other data, Microsoft calls Active Directory a "namespace" where names can be resolved.

ADS Benefits

ADS lets Thecus IP storage integrate itself with the existing ADS in an office environment. This means the Thecus IP storage is able to recognize your office users and passwords on the ADS server. Other major benefits ADS support provides include:

1. Easy integration of Thecus IP storage into the existing office IT infrastructure

The Thecus IP storage acts as a member of the ADS. This feature significantly lowers the overhead of the system administrator. For example, corporate security policies and user privileges on an ADS server can be enforced automatically on Thecus IP storage.

2. Centralized user/password database

The Thecus IP storage does not maintain its own copy of the user/password database. This avoids data inconsistency between Thecus IP storage and other servers. For example, without ADS support, an administrator might need to remove a specific user privilege on Thecus IP storage and each individual server. With ADS support, the change on an ADS server is known to all of its ADS members.

Appendix E: Licensing Information

Overview

This product included copyrighted third-party software licensed under the terms of GNU General Public License. Please see THE GNU General Public License for extra terms and conditions of this license.

Source Code Availability

Thecus Technology Corp. has exposed the full source code of the GPL licensed software. For more information on how you can obtain our source code, please visit our web site, <http://www.thecus.com>.

Copyrights

- This product includes cryptographic software written by Eric Young (eay@cryptsoft.com).
- This product includes software developed by Mark Murray.
- This product includes software developed by Eric Young (eay@cryptsoft.com).
- This product includes software developed by the OpenSSL Project for use in the OpenSSL Toolkit (<http://www.openssl.org/>).
- This product includes PHP, freely available from (<http://www.php.net/>).
- This product includes software developed by the University of California, Berkeley and its contributors.
- This product includes software developed by Winning Strategies, Inc.
- This product includes software developed by the Apache Group for use in the Apache HTTP server project (<http://www.apache.org/>).
- This product includes software developed by Softweyr LLC, the University of California, Berkeley, and its contributors.
- This product includes software developed by Bodo Moeller.
- This product includes software developed by Greg Roelofs and contributors for the book, "PNG: The Definitive Guide," published by O'Reilly and Associates.
- This product includes software developed by the NetBSD Foundation, Inc. and its contributors.
- This product includes software developed by Yen Yen Lim and North Dakota State University.
- This product includes software developed by the Computer Systems Engineering Group at Lawrence Berkeley Laboratory.
- This product includes software developed by the Kungliga Tekniska Högskolan and its contributors.
- This product includes software developed by the Nick Simicich.
- This product includes software written by Tim Hudson (tjh@cryptsoft.com).
- This product includes software developed by Christopher G. Demetriou for the NetBSD Project.

CGIC License Terms

Basic License

CGIC, copyright 1996, 1997, 1998, 1999, 2000, 2001, 2002, 2003, 2004 by Thomas Boutell and Boutell.Com, Inc.

Permission is granted to use CGIC in any application, commercial or noncommercial, at no cost. HOWEVER, this copyright paragraph must appear on a "credits" page accessible in the public online and offline documentation of the program. Modified versions of the CGIC library should not be distributed without the attachment of a clear statement regarding the author of the modifications, and this notice may in no case be removed. Modifications may also be submitted to the author for inclusion in the main CGIC distribution.

GNU General Public License

Version 2, June 1991

Copyright © 1989, 1991 Free Software Foundation, Inc.
51 Franklin St, Fifth Floor, Boston, MA 02110-1301 USA

Everyone is permitted to copy and distribute verbatim copies of this license document, but changing it is not allowed.

PREAMBLE

The licenses for most software are designed to take away your freedom to share and change it. By contrast, the GNU General Public License is intended to guarantee your freedom to share and change free software--to make sure the software is free for all its users. This General Public License applies to most of the Free Software Foundation's software and to any other program whose authors commit to using it. (Some other Free Software Foundation software is covered by the GNU Library General Public License instead.) You can apply it to your programs, too.

When we speak of free software, we are referring to freedom, not price. Our General Public Licenses are designed to make sure that you have the freedom to distribute copies of free software (and charge for this service if you wish), that you receive source code or can get it if you want it, that you can change the software or use pieces of it in new free programs; and that you know you can do these things.

To protect your rights, we need to make restrictions that forbid anyone to deny you these rights or to ask you to surrender the rights. These restrictions translate to certain responsibilities for you if you distribute copies of the software, or if you modify it.

For example, if you distribute copies of such a program, whether gratis or for a fee, you must give the recipients all the rights that you have. You must make sure that they, too, receive or can get the source code. And you must show them these terms so they know their rights.

We protect your rights with two steps: (1) copyright the software, and (2) offer you this license which gives you legal permission to copy, distribute and/or modify the software.

Also, for each author's protection and ours, we want to make certain that everyone understands that there is no warranty for this free software. If the software is

modified by someone else and passed on, we want its recipients to know that what they have is not the original, so that any problems introduced by others will not reflect on the original authors' reputations.

Finally, any free program is threatened constantly by software patents. We wish to avoid the danger that redistributors of a free program will individually obtain patent licenses, in effect making the program proprietary. To prevent this, we have made it clear that any patent must be licensed for everyone's free use or not licensed at all.

The precise terms and conditions for copying, distribution and modification follow.

TERMS AND CONDITIONS FOR COPYING, DISTRIBUTION AND MODIFICATION

0. This License applies to any program or other work which contains a notice placed by the copyright holder saying it may be distributed under the terms of this General Public License. The "Program", below, refers to any such program or work, and a "work based on the Program" means either the Program or any derivative work under copyright law: that is to say, a work containing the Program or a portion of it, either verbatim or with modifications and/or translated into another Language. (Hereinafter, translation is included without limitation in the term "modification".) Each licensee is addressed as "you".

Activities other than copying, distribution and modification are not covered by this License; they are outside its scope. The act of running the Program is not restricted, and the output from the Program is covered only if its contents constitute a work based on the Program (independent of having been made by running the Program).

Whether that is true depends on what the Program does.

1. You may copy and distribute verbatim copies of the Program's source code as you receive it, in any medium, provided that you conspicuously and appropriately publish on each copy an appropriate copyright notice and disclaimer of warranty; keep intact all the notices that refer to this License and to the absence of any warranty; and give any other recipients of the Program a copy of this License along with the Program.

You may charge a fee for the physical act of transferring a copy, and you may at your option offer warranty protection in exchange for a fee.

2. You may modify your copy or copies of the Program or any portion of it, thus forming a work based on the Program, and copy and distribute such modifications or work under the terms of Section 1 above, provided that you also meet all of these conditions:
 - a) You must cause the modified files to carry prominent notices stating that you changed the files and the date of any change.
 - b) You must cause any work that you distribute or publish, that in whole or in part contains or is derived from the Program or any part thereof, to be licensed as a whole at no charge to all third parties under the terms of this License.
 - c) If the modified program normally reads commands interactively when run, you must cause it, when started running for such interactive use in the most ordinary way, to print or display an announcement including an appropriate

copyright notice and a notice that there is no warranty (or else, saying that you provide a warranty) and that users may redistribute the program under these conditions, and telling the user how to view a copy of this License. (Exception: if the Program itself is interactive but does not normally print such an announcement, your work based on the Program is not required to print an announcement.)

These requirements apply to the modified work as a whole. If identifiable sections of that work are not derived from the Program, and can be reasonably considered independent and separate works in themselves, then this License, and its terms, do not apply to those sections when you distribute them as separate works. But when you distribute the same sections as part of a whole which is a work based on the Program, the distribution of the whole must be on the terms of this License, whose permissions for other licensees extend to the entire whole, and thus to each and every part regardless of who wrote it.

Thus, it is not the intent of this section to claim rights or contest your rights to work written entirely by you; rather, the intent is to exercise the right to control the distribution of derivative or collective works based on the Program.

In addition, mere aggregation of another work not based on the Program with the Program (or with a work based on the Program) on a volume of a storage or distribution medium does not bring the other work under the scope of this License.

3. You may copy and distribute the Program (or a work based on it, under Section 2) in object code or executable form under the terms of Sections 1 and 2 above provided that you also do one of the following:
 - a) Accompany it with the complete corresponding machine-readable source code, which must be distributed under the terms of Sections 1 and 2 above on a medium customarily used for software interchange; or,
 - b) Accompany it with a written offer, valid for at least three years, to give any third party, for a charge no more than your cost of physically performing source distribution, a complete machine-readable copy of the corresponding source code, to be distributed under the terms of Sections 1 and 2 above on a medium customarily used for software interchange; or,
 - c) Accompany it with the information you received as to the offer to distribute corresponding source code. (This alternative is allowed only for noncommercial distribution and only if you received the program in object code or executable form with such an offer, in accord with Subsection b above.)

The source code for a work means the preferred form of the work for making modifications to it. For an executable work, complete source code means all the source code for all modules it contains, plus any associated interface definition files, plus the scripts used to control compilation and installation of the executable. However, as a special exception, the source code distributed need not include anything that is normally distributed (in either source or binary form) with the major components (compiler, kernel, and so on) of the operating system on which the executable runs, unless that component itself accompanies the executable.

If distribution of executable or object code is made by offering access to copy from a designated place, then offering equivalent access to copy the source code from the same place counts as distribution of the source code, even

though third parties are not compelled to copy the source along with the object code.

4. You may not copy, modify, sublicense, or distribute the Program except as expressly provided under this License. Any attempt otherwise to copy, modify, sublicense or distribute the Program is void, and will automatically terminate your rights under this License. However, parties who have received copies, or rights, from you under this License will not have their licenses terminated so long as such parties remain in full compliance.
5. You are not required to accept this License, since you have not signed it. However, nothing else grants you permission to modify or distribute the Program or its derivative works. These actions are prohibited by law if you do not accept this License. Therefore, by modifying or distributing the Program (or any work based on the Program), you indicate your acceptance of this License to do so, and all its terms and conditions for copying, distributing or modifying the Program or works based on it.
6. Each time you redistribute the Program (or any work based on the Program), the recipient automatically receives a license from the original licensor to copy, distribute or modify the Program subject to these terms and conditions. You may not impose any further restrictions on the recipients' exercise of the rights granted herein. You are not responsible for enforcing compliance by third parties to this License.
7. If, as a consequence of a court judgment or allegation of patent infringement or for any other reason (not limited to patent issues), conditions are imposed on you (whether by court order, agreement or otherwise) that contradict the conditions of this License, they do not excuse you from the conditions of this License. If you cannot distribute so as to satisfy simultaneously your obligations under this License and any other pertinent obligations, then as a consequence you may not distribute the Program at all. For example, if a patent license would not permit royalty-free redistribution of the Program by all those who receive copies directly or indirectly through you, then the only way you could satisfy both it and this License would be to refrain entirely from distribution of the Program.

If any portion of this section is held invalid or unenforceable under any particular circumstance, the balance of the section is intended to apply and the section as a whole is intended to apply in other circumstances.

It is not the purpose of this section to induce you to infringe any patents or other property right claims or to contest validity of any such claims; this section has the sole purpose of protecting the integrity of the free software distribution system, which is implemented by public license practices. Many people have made generous contributions to the wide range of software distributed through that system in reliance on consistent application of that system; it is up to the author/donor to decide if he or she is willing to distribute software through any other system and a licensee cannot impose that choice.

This section is intended to make thoroughly clear what is believed to be a consequence of the rest of this License.

8. If the distribution and/or use of the Program is restricted in certain countries either by patents or by copyrighted interfaces, the original copyright holder who places the Program under this License may add an explicit geographical distribution limitation excluding those countries, so that distribution is

permitted only in or among countries not thus excluded. In such case, this License incorporates the limitation as if written in the body of this License.

9. The Free Software Foundation may publish revised and/or new versions of the General Public License from time to time. Such new versions will be similar in spirit to the present version, but may differ in detail to address new problems or concerns.

Each version is given a distinguishing version number. If the Program specifies a version number of this License which applies to it and "any later version", you have the option of following the terms and conditions either of that version or of any later version published by the Free Software Foundation. If the Program does not specify a version number of this License, you may choose any version ever published by the Free Software Foundation.

10. If you wish to incorporate parts of the Program into other free programs whose distribution conditions are different, write to the author to ask for permission. For software which is copyrighted by the Free Software Foundation, write to the Free Software Foundation; we sometimes make exceptions for this. Our decision will be guided by the two goals of preserving the free status of all derivatives of our free software and of promoting the sharing and reuse of software generally.

NO WARRANTY

11. BECAUSE THE PROGRAM IS LICENSED FREE OF CHARGE, THERE IS NO WARRANTY FOR THE PROGRAM, TO THE EXTENT PERMITTED BY APPLICABLE LAW. EXCEPT WHEN OTHERWISE STATED IN WRITING THE COPYRIGHT HOLDERS AND/OR OTHER PARTIES PROVIDE THE PROGRAM "AS IS" WITHOUT WARRANTY OF ANY KIND, EITHER EXPRESSED OR IMPLIED, INCLUDING, BUT NOT LIMITED TO, THE IMPLIED WARRANTIES OF MERCHANTABILITY AND FITNESS FOR A PARTICULAR PURPOSE. THE ENTIRE RISK AS TO THE QUALITY AND PERFORMANCE OF THE PROGRAM IS WITH YOU. SHOULD THE PROGRAM PROVE DEFECTIVE, YOU ASSUME THE COST OF ALL NECESSARY SERVICING, REPAIR OR CORRECTION.
12. IN NO EVENT UNLESS REQUIRED BY APPLICABLE LAW OR AGREED TO IN WRITING WILL ANY COPYRIGHT HOLDER, OR ANY OTHER PARTY WHO MAY MODIFY AND/OR REDISTRIBUTE THE PROGRAM AS PERMITTED ABOVE, BE LIABLE TO YOU FOR DAMAGES, INCLUDING ANY GENERAL, SPECIAL, INCIDENTAL OR CONSEQUENTIAL DAMAGES ARISING OUT OF THE USE OR INABILITY TO USE THE PROGRAM (INCLUDING BUT NOT LIMITED TO LOSS OF DATA OR DATA BEING RENDERED INACCURATE OR LOSSES SUSTAINED BY YOU OR THIRD PARTIES OR A FAILURE OF THE PROGRAM TO OPERATE WITH ANY OTHER PROGRAMS), EVEN IF SUCH HOLDER OR OTHER PARTY HAS BEEN ADVISED OF THE POSSIBILITY OF SUCH DAMAGES.

END OF TERMS AND CONDITIONS