

BR-6428nS V5

User Manual

12-2018 / v1.0

Edimax Technology Co., Ltd.

No. 278, Xinhu 1st Rd., Neihu Dist., Taipei City, Taiwan

Email: support@edimax.com.tw

Edimax Technology Europe B.V.

Fijenhof 2, 5652 AE Eindhoven, The Netherlands

Email: support@edimax.nl

Edimax Computer Company

3350 Scott Blvd., Bldg.15 Santa Clara, CA 95054, USA

Live Tech Support: 1(800) 652-6776

Email: support@edimax.com

CONTENTS

I. Product Information.....	1
I-1. Package Contents	1
I-2. LED Status	2
I-3. Back Panel.....	3
II. Installation.....	5
II-1. Wi-Fi Router Mode	8
II-2. WISP Mode	11
II-3. Universal Repeater Mode.....	14
II-4. Access Point Mode.....	17
II-5. WPS Setup.....	20
II-6. Reset to Factory Default Settings	20
III. Browser Based Configuration Interface.....	21
III-1. Login.....	21
III-2. Main Menu	23
III-2-1. Commonly used web elements	24
III-2-2. Setup Wizard.....	25
III-2-3. Status	27
III-2-3-1. System Status.....	28
III-2-3-2. LAN Status.....	28
III-2-3-3. Wireless Status	29
III-2-3-4. WAN Status.....	30
III-3. Network	30
III-3-1. WAN Settings	31
III-3-1-5. WAN Settings- L2TP	35
III-3-2. WAN Speed.....	36
IV. Appendix	64
IV-1. Configuring your IP address.....	64
IV-1-1. How to check that your computer uses a dynamic IP address	65
IV-1-1-1. Windows 7	65
IV-1-1-2. Windows 8	69
IV-1-1-3. Windows 10	73
IV-1-1-4. Mac OS.....	75
IV-1-2. How to modify the IP address of your computer	77
IV-1-2-1. Windows 7	77
IV-1-2-2. Windows 8	80
IV-1-2-3. Windows 10	84

IV-1-2-4.	Mac	86
IV-1-3.	How to Find Your Network Security Key	88
IV-1-3-1.	Windows 7 & 8.....	88
IV-1-3-2.	Windows 10	91
IV-1-3-3.	Mac	92
IV-1-4.	How to Find Your Router’s IP Address.....	95
IV-1-4-1.	Windows 7	95
IV-1-4-2.	Windows 8	97
IV-1-4-3.	Window 10.....	99
IV-1-4-4.	Mac	100
IV-2.	Connecting to a Wi-Fi network.....	102
IV-3.	Troubleshooting.....	103
Step 1:	Right-click the Network icon and select Properties.	105
Step 2:	Select Manage Wireless Networks.	105
Step 3:	Select the wireless network and click Remove network.....	105

I. Product Information

I-1. Package Contents

Before you start using this product, please check if there is anything missing in the package, and contact your dealer to claim the missing item(s):

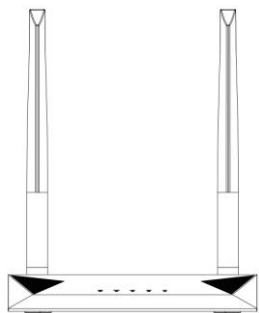

***BR-6428nS V5
(5dBi Antenna x 2)***



CD-ROM

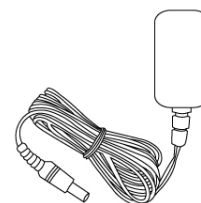

Power Adapter

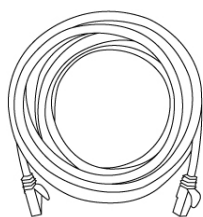







Ethernet Cable

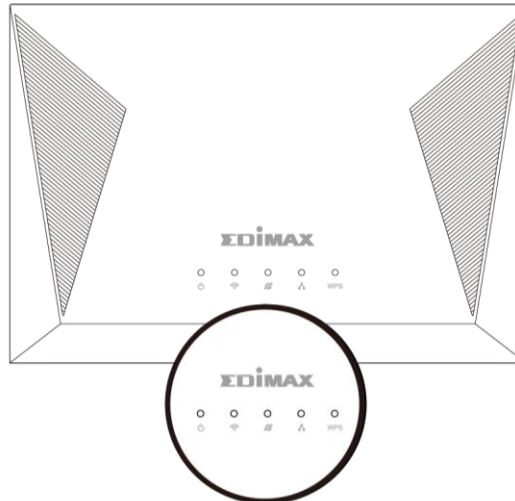

Quick Installation Guide

I-2. LED Status



LED	LED Colors	LED Status	Description
WPS 	Green	On	<i>Negotiation is in progress through Wi-Fi Protected Setup.</i>
		Quick Flashing	<i>Reset factory settings</i>
		Slow Flashing	<i>WPS in progress</i>
		Off	<i>WPS is disabled or connected.</i>
PWR 	Green	On	<i>Device is on.</i>
		Quick Flashing	<i>Reset factory settings</i>
		Slow Flashing	<i>Firmware upgrade in process</i>
		Off	<i>Device is off.</i>
WAN 	Green	On	<i>WAN port connected.</i>
		Flashing	<i>WAN activity.</i>
		Off	<i>WAN port not connected.</i>
WLAN 	Blue	On	<i>Wi-Fi wireless activity (transferring/receiving data).</i>
		Quick Flashing	<i>Reset factory settings</i>
		Off	<i>Wi-Fi not active.</i>
LAN 	Green	On	<i>Ethernet port is connected to a network device.</i>
		Flashing	<i>LAN activity.</i>
		Off	<i>Ethernet port is not connected to a network device.</i>

I-3. Back Panel

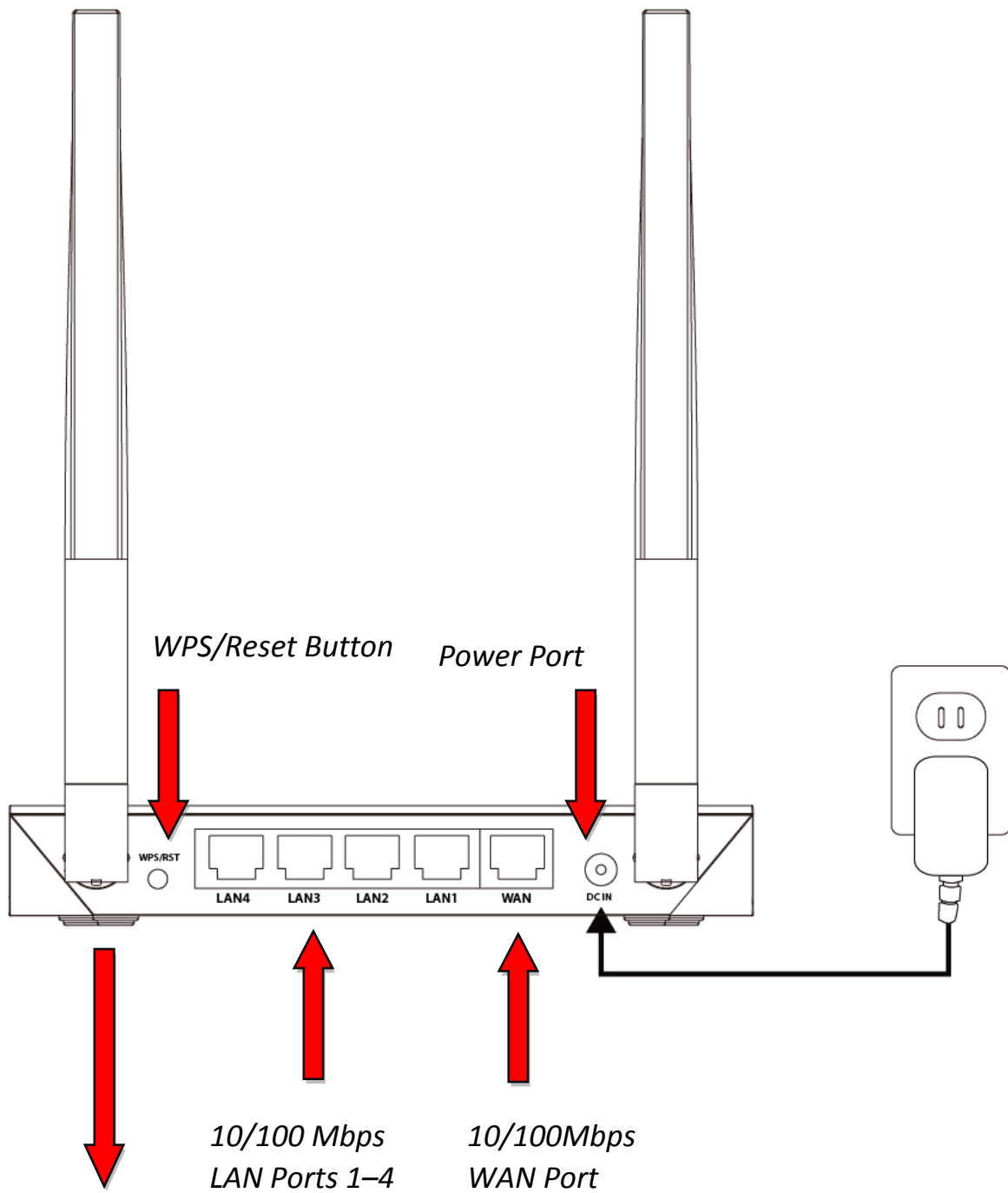

BR 6428nS V5 Fixed 5dBi Antenna x 2

I-4. Safety Information

In order to ensure the safe operation of the device and its users, please read and act in accordance with the following safety instructions.

1. The device is designed for indoor use only; do not place it outdoors.
2. Do not place the device in or near hot/humid places, such as a kitchen or bathroom.
3. Do not pull any connected cable with force; carefully disconnect it from the BR-6428nS V5.
4. Handle the device with care. Accidental damage will void the warranty of the device.
5. The device contains small parts which are a danger to small children under 3 years old. Please keep the device out of reach of children.
6. Do not place the device on paper, cloth, dust, corrosive liquids or other flammable materials. The device may become hot during use.
7. There are no user-serviceable parts inside the device. If you experience problems with the device, please contact your dealer of purchase and ask for help.
8. The device is an electrical device and as such, if it becomes wet for any reason, do not attempt to touch it without switching the power supply off. Contact an experienced electrical technician for further help.
9. Plug this product directly into a wall socket (100-240V~, 50/60Hz). Do not use an extension cord between this product and the AC power source.
10. The Operating temperature is 0°C~40°C (32°F~104°F). The Storage temperature is -40°C~70°C (-40°F~158°F).

II. Installation

1. Plug the included power adapter into the device's 5V DC power port and the other end into an electrical socket.

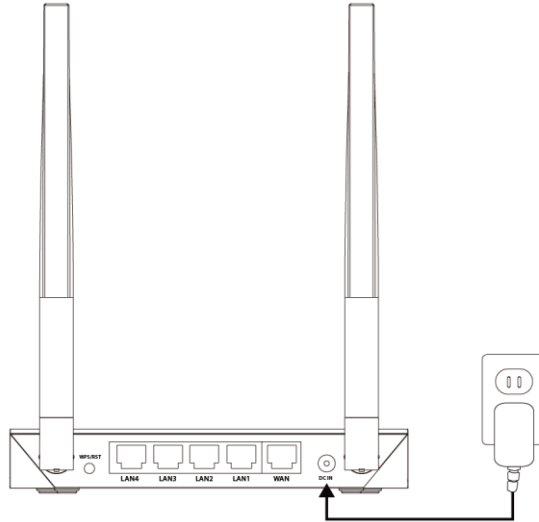

2. Ensure that the power LED is lit. If not, the device is not properly connected.

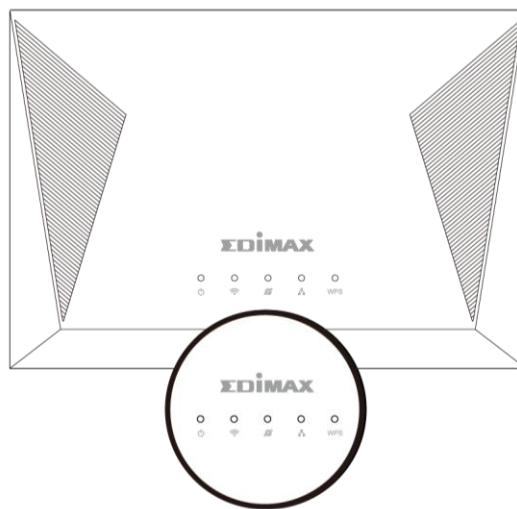

3. Use a Wi-Fi device (e.g. computer, tablet, smartphone) to search for a Wi-Fi network with the SSID “edimax.setup” and connect to it.



iOS 4 or Android 4 and above are required for setup on a smartphone or tablet.

4. Open a web browser and if you do not automatically arrive at the log in screen shown below, enter the URL ***http://192.168.2.1*** and begin the setup process.

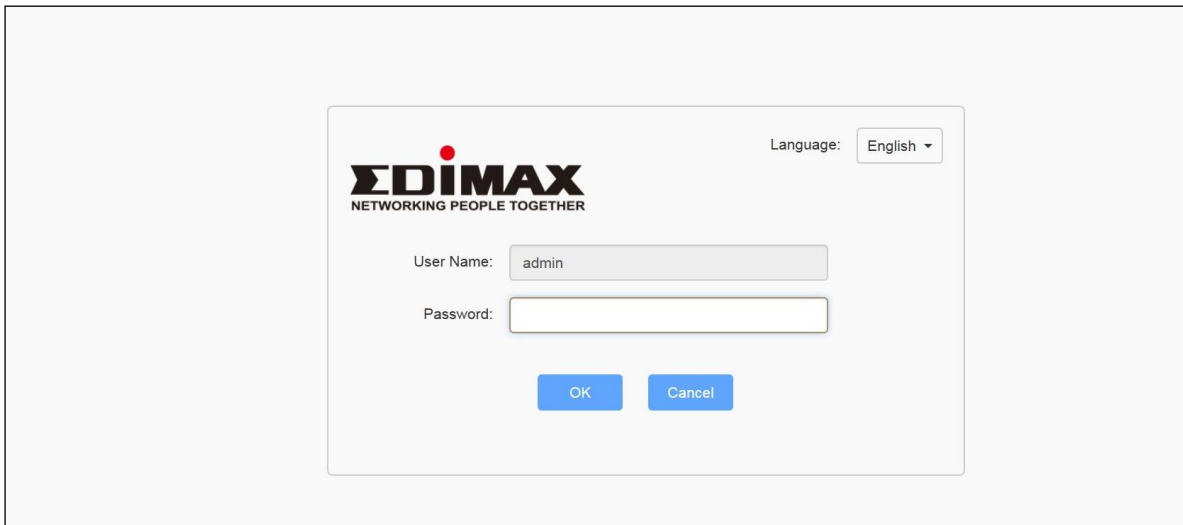

The image shows a login window for EDIMAX. At the top left is the EDIMAX logo with the tagline "NETWORKING PEOPLE TOGETHER". At the top right, there is a "Language:" dropdown menu set to "English". Below the logo, there are two input fields: "User Name:" with the text "admin" and "Password:". At the bottom of the window are two buttons: "OK" and "Cancel".

 ***If you cannot access <http://192.168.2.1>, please make sure your computer is set to use a dynamic IP address. Refer to [IV-1. Configuring your IP address](#) for more information.***

5. Enter new password, confirmed and click "NEXT" to continue.

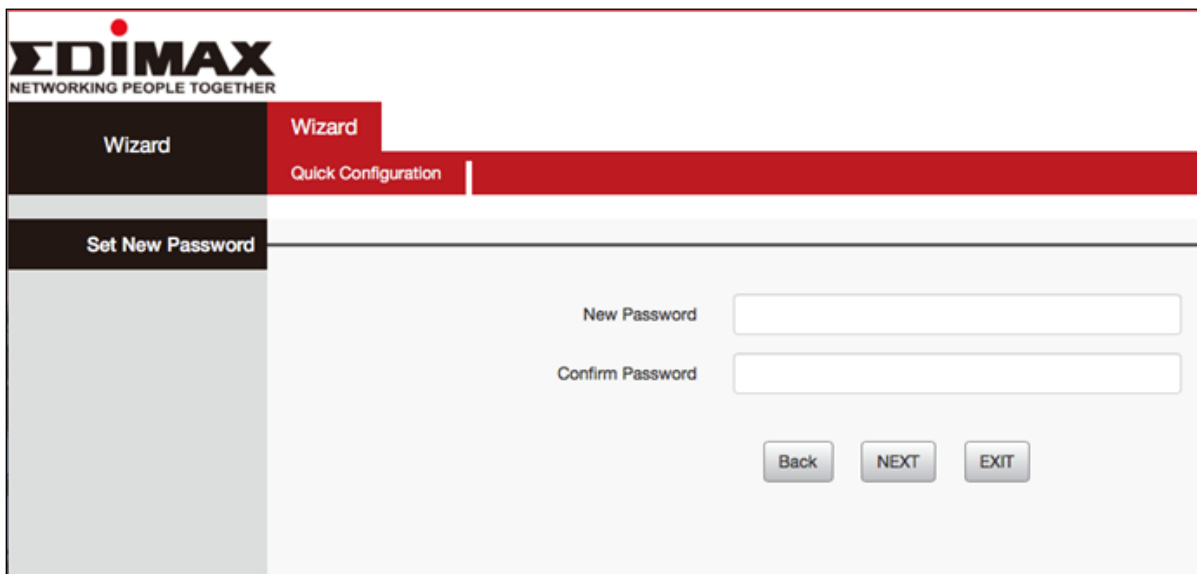

The image shows the "Set New Password" step of the EDIMAX configuration wizard. The top left features the EDIMAX logo and tagline. Below it is a navigation bar with "Wizard" and "Quick Configuration" tabs. The main content area has two input fields: "New Password" and "Confirm Password". At the bottom right are three buttons: "Back", "NEXT", and "EXIT".

6. Select the mode for your BR-6428nS V5 and click “NEXT” to continue.

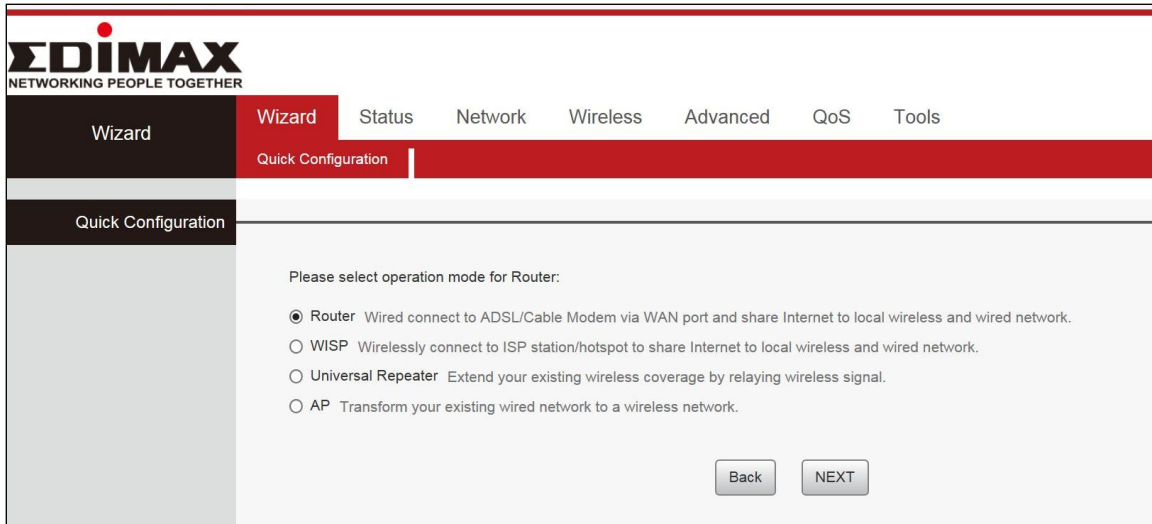

Wi-Fi Router	<i>The device connects to your modem and enables Internet (wireless and Ethernet) access on your network devices.</i>
WISP Mode	<i>The device connects wirelessly to your Wireless Internet Service Provider and provides 2.4GHz and/or 5GHz Internet (wireless and Ethernet) access for your network devices.</i>
Universal Repeater	<i>The device will act as a wireless range extender that will help you to extend your Wi-Fi network. The device acts as a client and AP at the same time. In its client function to connect to a root AP, and uses its AP function to service wireless clients within its coverage.</i>
Access Point	<i>The device connects to an existing router via Ethernet cable and provides Internet (wireless and Ethernet) access for your network devices.</i>

Follow the appropriate instructions for your operating mode:

II-1. Wi-Fi Router Mode

1. Connect the **blue** WAN port of your BR-6428nS V5 to the LAN port of your modem using an Ethernet cable, and then log on to <http://192.168.2.1>.
2. Select “Router” mode and click “NEXT”.

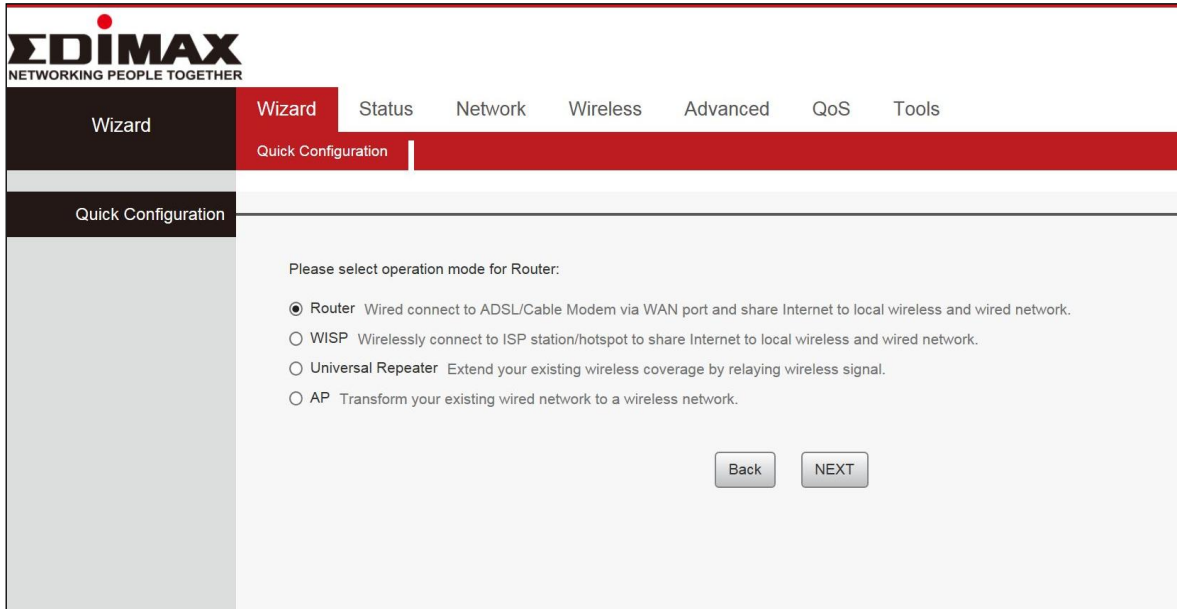

3. You can select “Dynamic IP”, “Static IP”, and “PPPOE” mode.

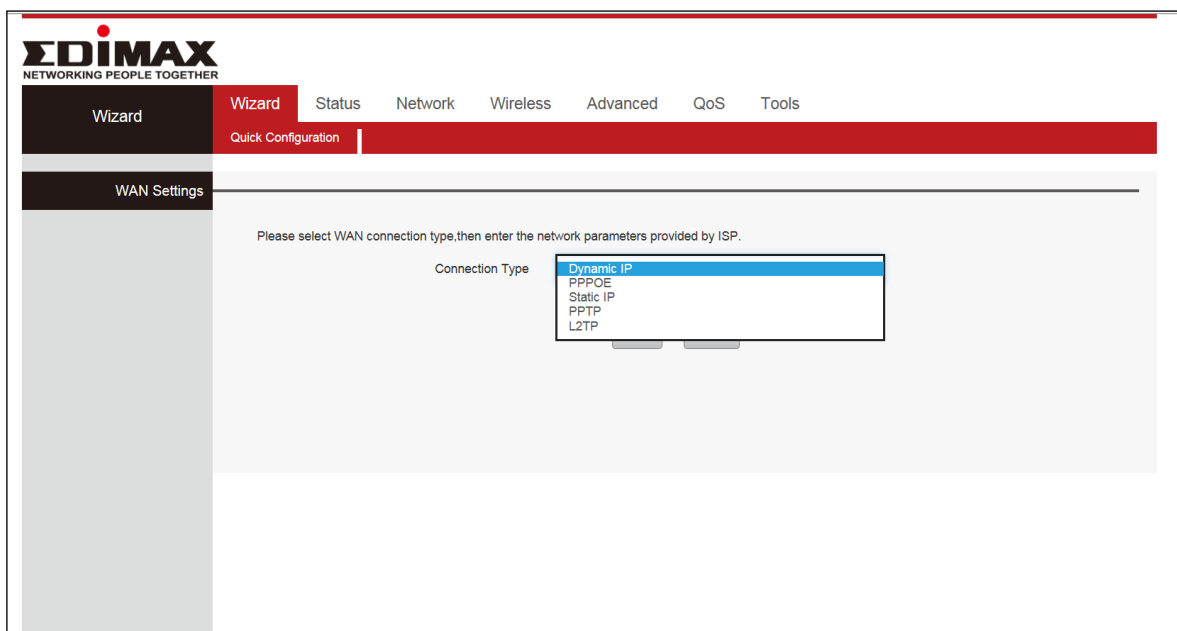

4. Confirm the configuration details for your wireless network, then click “NEXT” to continue.

EDIMAX
NETWORKING PEOPLE TOGETHER

Wizard Wizard Status Network Wireless Advanced QoS Tools

Quick Configuration

Wireless Settings

This sector is used to set wireless parameters for your local network,pls remember the Pass Phrase!

SSID: EDIMAX_C6AA34

Channel: 2422MHz (Channel 3)

Security Mode: WPA2 - Personal

WPA Algorithms: AES TKIP TKIP&AES

Pass Phrase:

Back NEXT

Support Wireless Roaming

5. Please click “Save” to reboot the device and activate the configuration.

EDIMAX
NETWORKING PEOPLE TOGETHER

Wizard Wizard Status Network Wireless Advanced QoS Tools

Quick Configuration

Congratulations!

You are configuring the device to work as Router mode . If you have confirmed settings,please click Save to reboot the device and activate the configuration.

Back Save

6. Please wait a moment until the BR-6428nS V5 is ready.

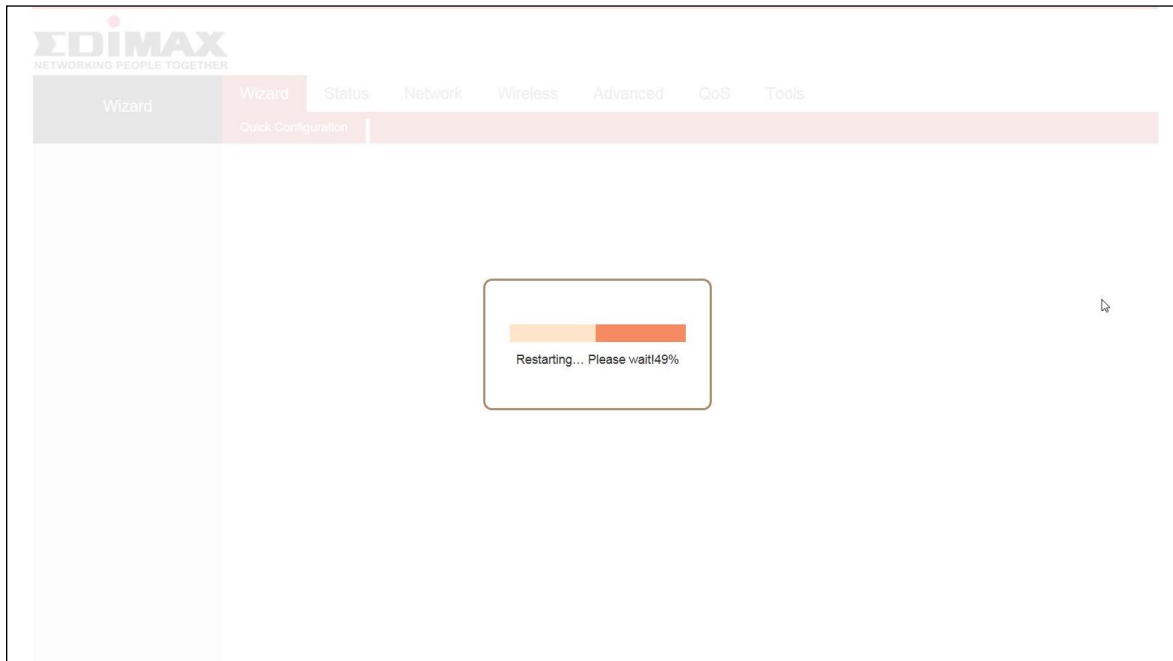

7. When the setup is complete. ***Please close the browser window.***

8. The BR-6428nS V5 is working and ready for use. You can now connect to the device's new SSID. Please refer to [IV-2. Connecting to a Wi-Fi network](#) if you require more guidance.

II-2. WISP Mode

1. Please ensure your BR-6478nS V5 is within Wi-Fi range of your WISP network. Log on to <http://192.168.2.1> to configure your device.

2. Select WISP mode and click “NEXT”.

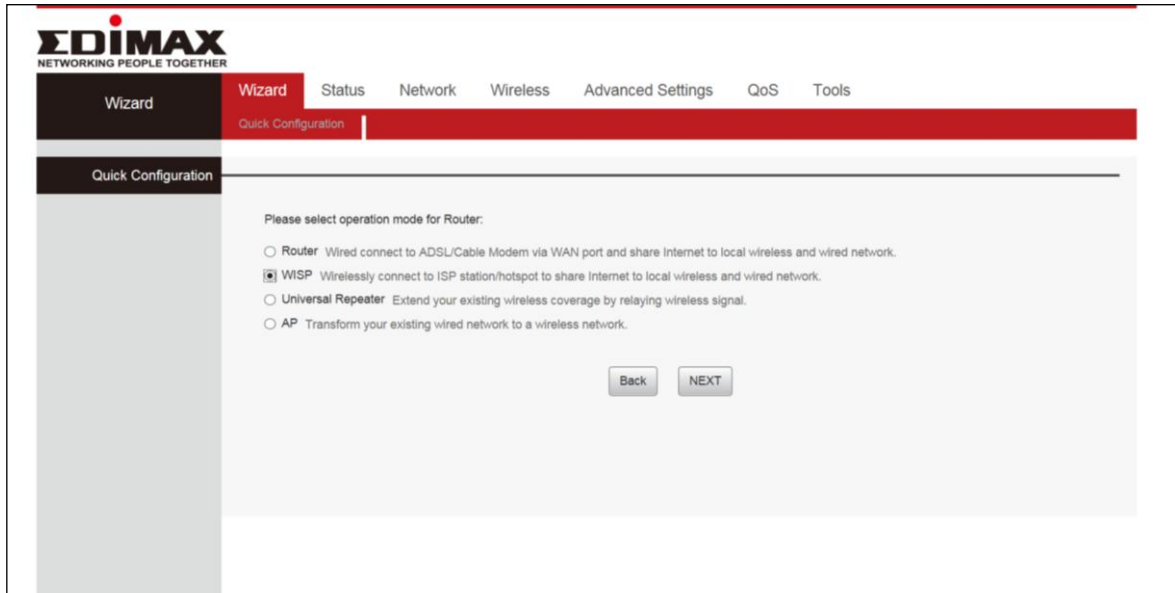

The screenshot shows the EDIMAX web interface. The top navigation bar includes 'Wizard', 'Status', 'Network', 'Wireless', 'Advanced Settings', 'QoS', and 'Tools'. The 'Wizard' section is active, and the 'Quick Configuration' sub-section is selected. The main content area displays the instruction: 'Please select operation mode for Router:'. There are four radio button options: 'Router' (Wired connect to ADSL/Cable Modem via WAN port and share Internet to local wireless and wired network.), 'WISP' (Wirelessly connect to ISP station/hotspot to share Internet to local wireless and wired network.), 'Universal Repeater' (Extend your existing wireless coverage by relaying wireless signal.), and 'AP' (Transform your existing wired network to a wireless network.). The 'WISP' option is selected. Below the options are 'Back' and 'NEXT' buttons.

3. Click “Site Survey” to scan the wireless signals and connect to desired device.

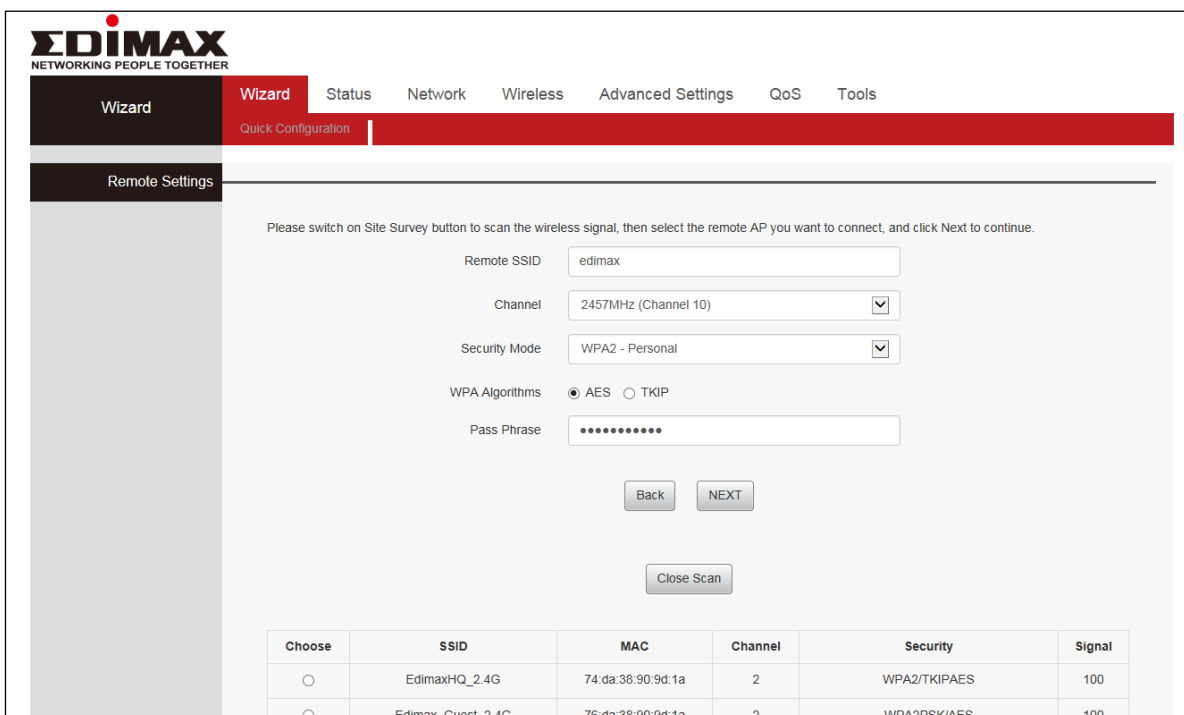

The screenshot shows the EDIMAX web interface. The top navigation bar includes 'Wizard', 'Status', 'Network', 'Wireless', 'Advanced Settings', 'QoS', and 'Tools'. The 'Wizard' section is active, and the 'Remote Settings' sub-section is selected. The main content area displays the instruction: 'Please switch on Site Survey button to scan the wireless signal, then select the remote AP you want to connect, and click Next to continue.' Below the instruction are several input fields: 'Remote SSID' (text box with 'edimax'), 'Channel' (dropdown menu with '2457MHz (Channel 10)'), 'Security Mode' (dropdown menu with 'WPA2 - Personal'), 'WPA Algorithms' (radio buttons for 'AES' and 'TKIP', with 'AES' selected), and 'Pass Phrase' (password field with masked characters). Below these fields are 'Back', 'NEXT', and 'Close Scan' buttons. At the bottom, there is a table with the following data:

Choose	SSID	MAC	Channel	Security	Signal
<input type="radio"/>	EdimaxHQ_2.4G	74:da:38:90:9d:1a	2	WPA2/TKIP/AES	100
<input type="radio"/>	Edimax_Guest_2.4G	76:da:38:90:9d:1a	2	WPA2PSK/AES	100

4. A summary of your wireless configuration will be displayed, as shown below. Check that all of the details are correct and then click “NEXT” to proceed.

The screenshot shows the EDIMAX web interface. The top navigation bar includes 'Wizard', 'Status', 'Network', 'Wireless', 'Advanced Settings', 'QoS', and 'Tools'. The 'Wizard' section is active, with 'Quick Configuration' selected. The 'Wireless Settings' page contains the following fields:

- SSID: EDIMAX_C6AA34
- Channel: 2457MHz (Channel 10)
- Security Mode: WPA2 - Personal
- Pass Phrase: [Redacted]

Buttons for 'Back' and 'NEXT' are located at the bottom of the form.

5. Please click “Save” to reboot the device and activate the configuration.

The screenshot shows the EDIMAX web interface. The top navigation bar is the same as in the previous screenshot. The 'Wizard' section is active, with 'Quick Configuration' selected. The 'Congratulations!' page contains the following text:

You are configuring the device to work as **WISP mode** . If you have confirmed settings, please click Save to reboot the device and activate the configuration.

Buttons for 'Back' and 'Save' are located at the bottom of the form.

6. Please wait a moment until the BR-6428nS V5 is ready.

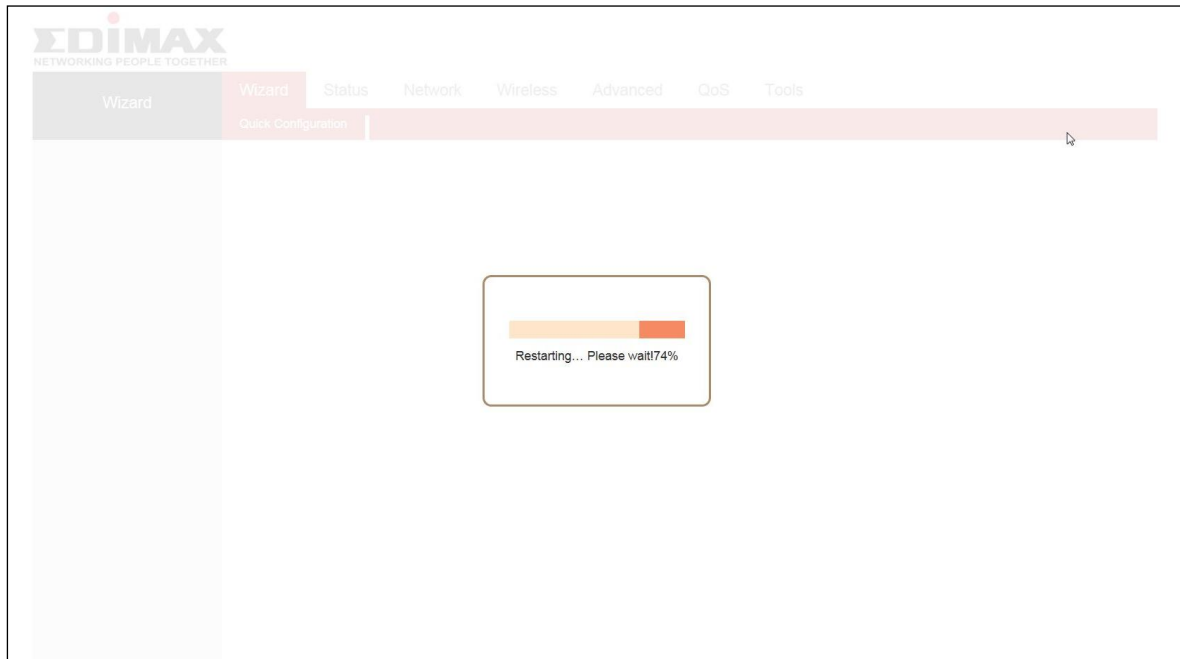

7. When the setup is complete, please close the browser window.

8. The BR-6428nS V5 is working and ready for use. You can now connect to the device's new SSID. Please refer to [IV-2. Connecting to a Wi-Fi network](#) if you require more guidance.

II-3. Universal Repeater Mode

1. Please ensure your BR-6428nS V5 is within Wi-Fi range of your existing wireless router. Log on to <http://192.168.2.1> to configure your device.
2. Select Repeater Mode and click “NEXT”.

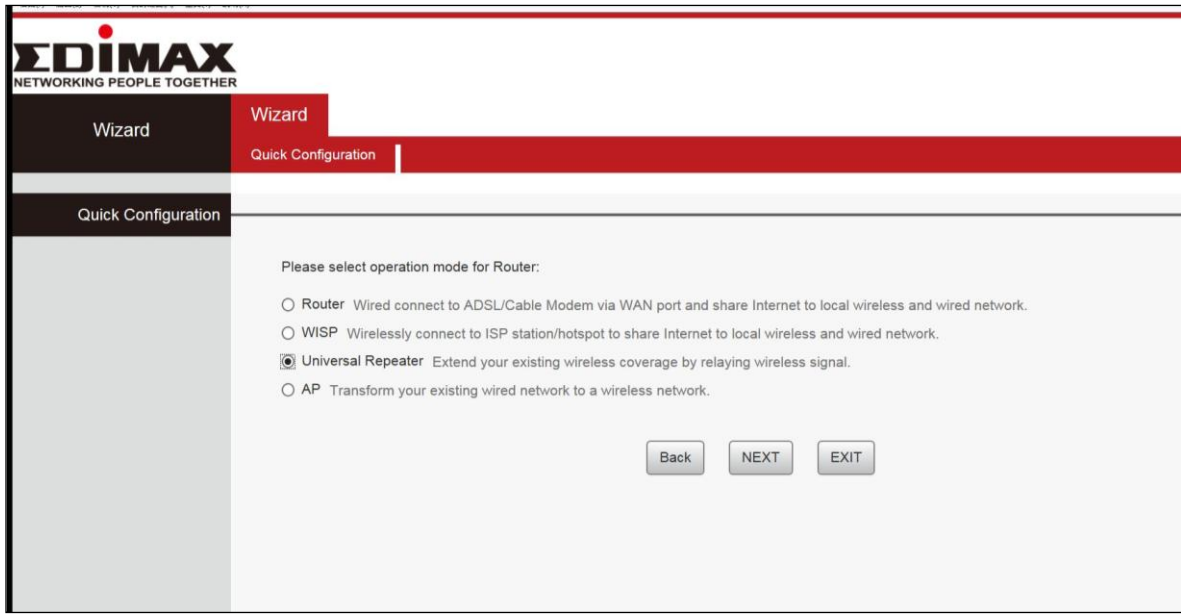

EDIMAX
NETWORKING PEOPLE TOGETHER

Wizard

Wizard

Quick Configuration

Quick Configuration

Please select operation mode for Router:

- Router Wired connect to ADSL/Cable Modem via WAN port and share Internet to local wireless and wired network.
- WISP Wirelessly connect to ISP station/hotspot to share Internet to local wireless and wired network.
- Universal Repeater Extend your existing wireless coverage by relaying wireless signal.
- AP Transform your existing wired network to a wireless network.

Back NEXT EXIT



If the Wi-Fi network you wish to connect to does not appear, try clicking “Refresh”.

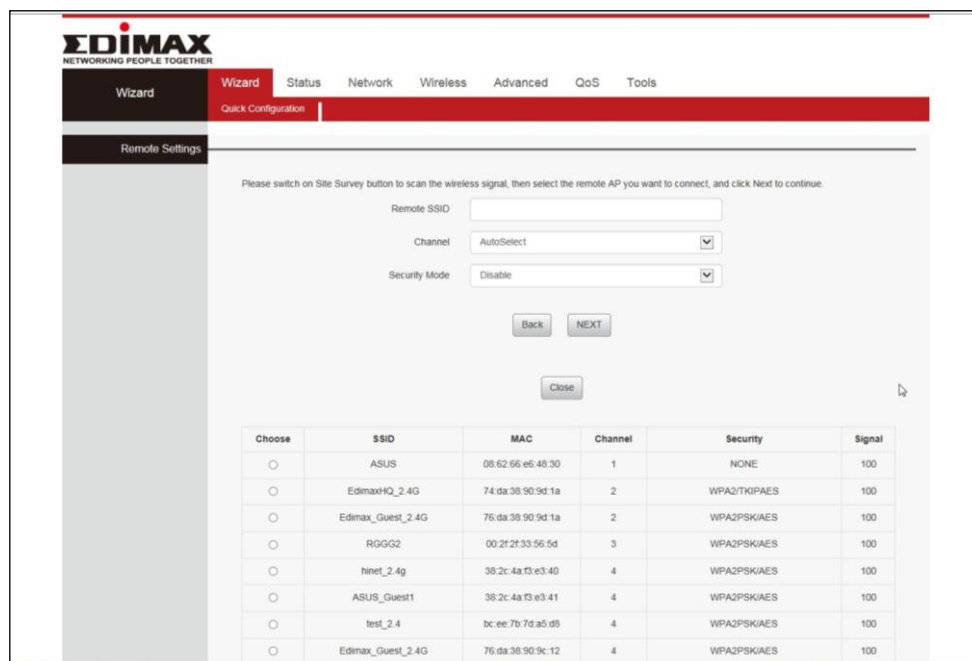

EDIMAX
NETWORKING PEOPLE TOGETHER

Wizard

Wizard Status Network Wireless Advanced CoS Tools

Quick Configuration

Remote Settings

Please switch on Site Survey button to scan the wireless signal, then select the remote AP you want to connect, and click Next to continue.

Remote SSID

Channel AutoSelect

Security Mode Disable

Back NEXT

Close

Choose	SSID	MAC	Channel	Security	Signal
<input type="radio"/>	ASUS	08:62:66:e6:48:30	1	NONE	100
<input type="radio"/>	EdimaxHQ_2_4G	74:da:38:90:9d:1a	2	WPA2/TKIP/AES	100
<input type="radio"/>	Edimax_Guest_2_4G	75:da:38:90:9d:1a	2	WPA2PSK/AES	100
<input type="radio"/>	RGGG2	00:2f:2f:33:56:5d	3	WPA2PSK/AES	100
<input type="radio"/>	hinet_2_4g	38:2c:4a:f3:e3:40	4	WPA2PSK/AES	100
<input type="radio"/>	ASUS_Guest1	38:2c:4a:f3:e3:41	4	WPA2PSK/AES	100
<input type="radio"/>	test_2_4	bc:ee:7b:7d:a5:d9	4	WPA2PSK/AES	100
<input type="radio"/>	Edimax_Guest_2_4G	76:da:38:90:9c:12	4	WPA2PSK/AES	100

3. The device will search for nearby wireless networks to connect to. If you cannot find the access point you wish to connect to, click “Site Survey” to refresh the list of wireless networks. Select the wireless network you wish to connect to, and click “NEXT” to continue.
4. A summary of your wireless configuration will be displayed, as shown below. Check that all of the details are correct and then click “NEXT” to proceed. Click on Support Wireless Roaming to display the existing wireless configuration.

The screenshot shows the EDIMAX web interface with the 'Wireless' tab selected. The 'Wireless Settings' section is active, displaying the following configuration:

- SSID: EDIMAX_C6AA34
- Channel: 2422MHz (Channel 3)
- Security Mode: WPA2 - Personal
- WPA Algorithms: AES TKIP TKIP&AES
- Pass Phrase: [Redacted]

Buttons for 'Back', 'NEXT', and 'Support Wireless Roaming' are visible at the bottom of the configuration area.

The screenshot shows the EDIMAX web interface with the 'Wireless' tab selected. The 'Wireless Settings' section is active, displaying the following configuration:

- SSID: RGGG2
- Channel: AutoSelect
- Security Mode: WPA2 - Personal
- WPA Algorithms: AES TKIP TKIP&AES
- Pass Phrase: [Redacted]

Buttons for 'Back', 'NEXT', and 'Recovery Configuration' are visible at the bottom of the configuration area.

 **The device will use the same wireless password/security key as the existing wireless network.**

5.Please click “Save” to reboot the device and activate the configuration.

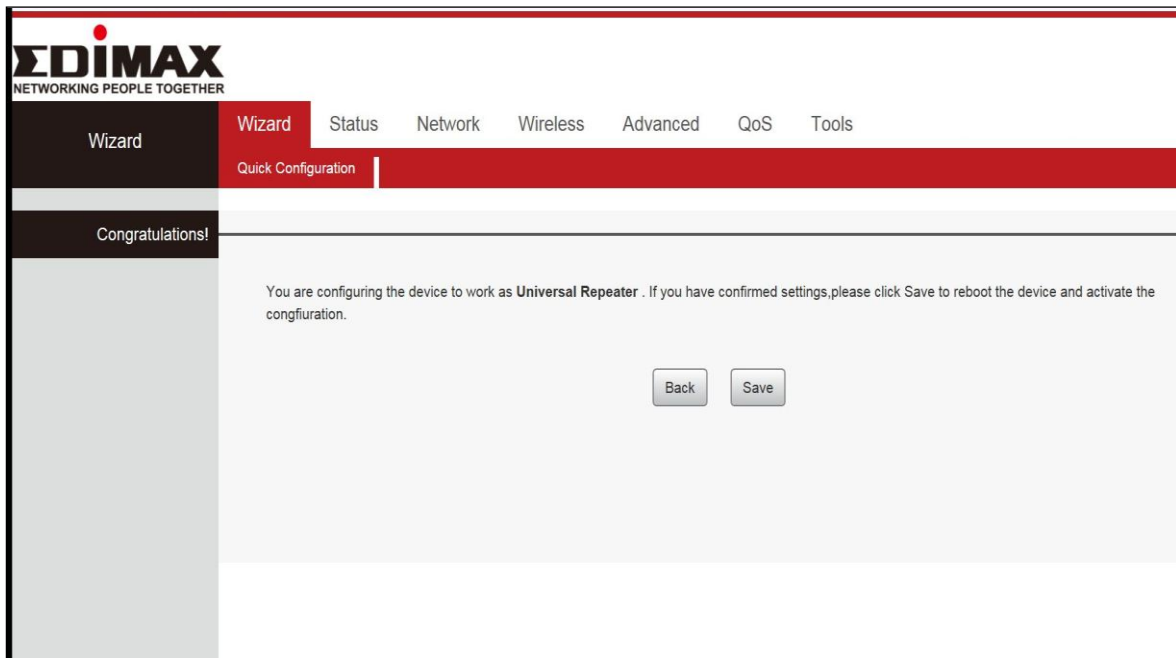

6.Please wait a moment until the BR-6428nS V5 is ready.

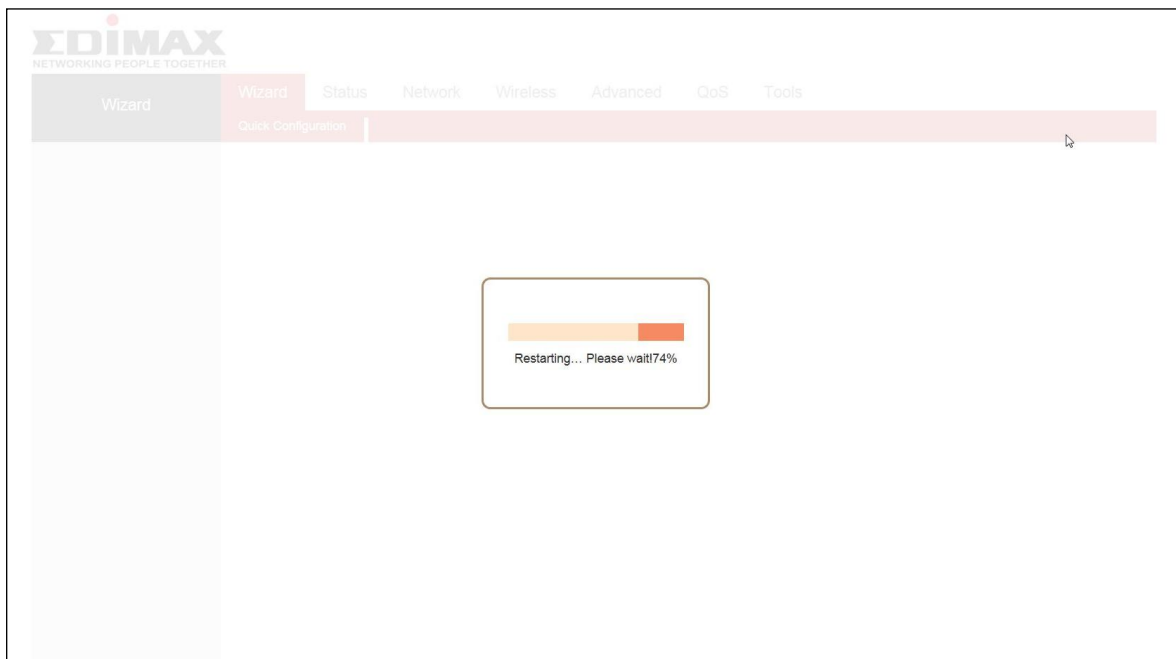

7.When the setup is complete. ***Please close the browser window.***

8.The BR-6428nS V5 is working and ready for use. You can now connect to the device’s new SSID. Please refer to [IV-2. Connecting to a Wi-Fi network](#) if you require more guidance.

II-4. Access Point Mode

1. Connect the yellow LAN port of your BR-6428nS V5 to the LAN port of your existing router using an Ethernet cable, and then log on to <http://192.168.2.1>.
2. Select “AP” mode and click “NEXT”.

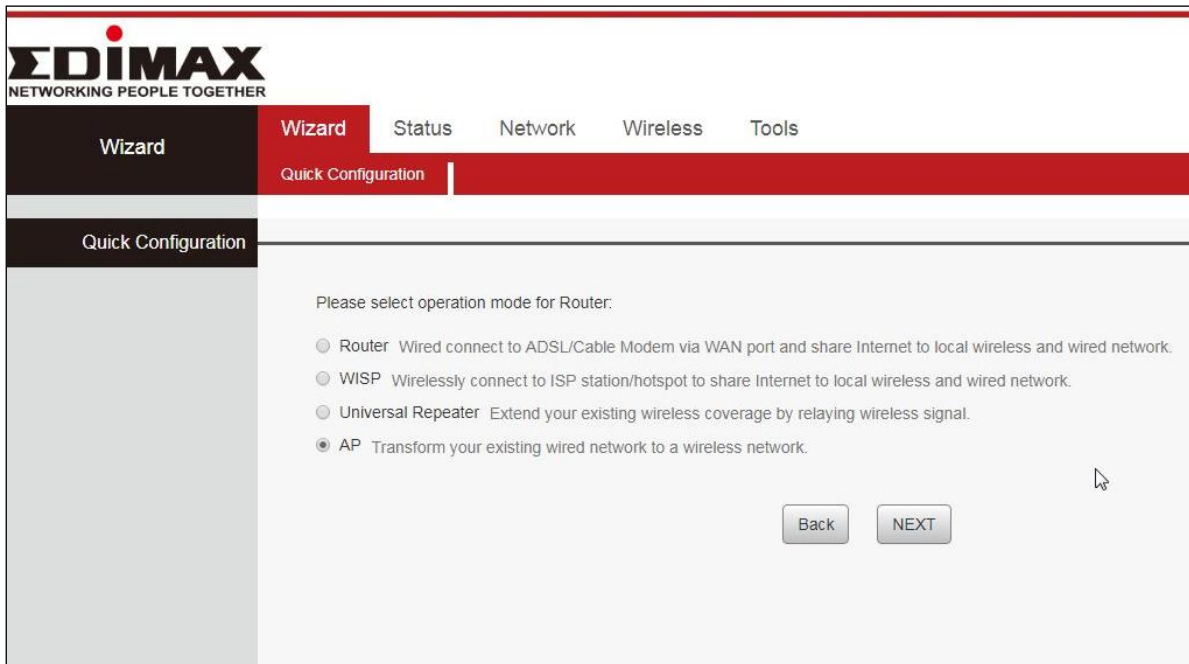

The screenshot shows the EDIMAX web interface. The top navigation bar includes 'Wizard', 'Status', 'Network', 'Wireless', and 'Tools'. The 'Wizard' section is active, and the 'Quick Configuration' step is selected. The main content area displays the text 'Please select operation mode for Router:' followed by four radio button options: 'Router', 'WISP', 'Universal Repeater', and 'AP'. The 'AP' option is selected. Below the options are 'Back' and 'NEXT' buttons.

3. Confirm the configuration details for your wireless network, then click “NEXT” to continue.

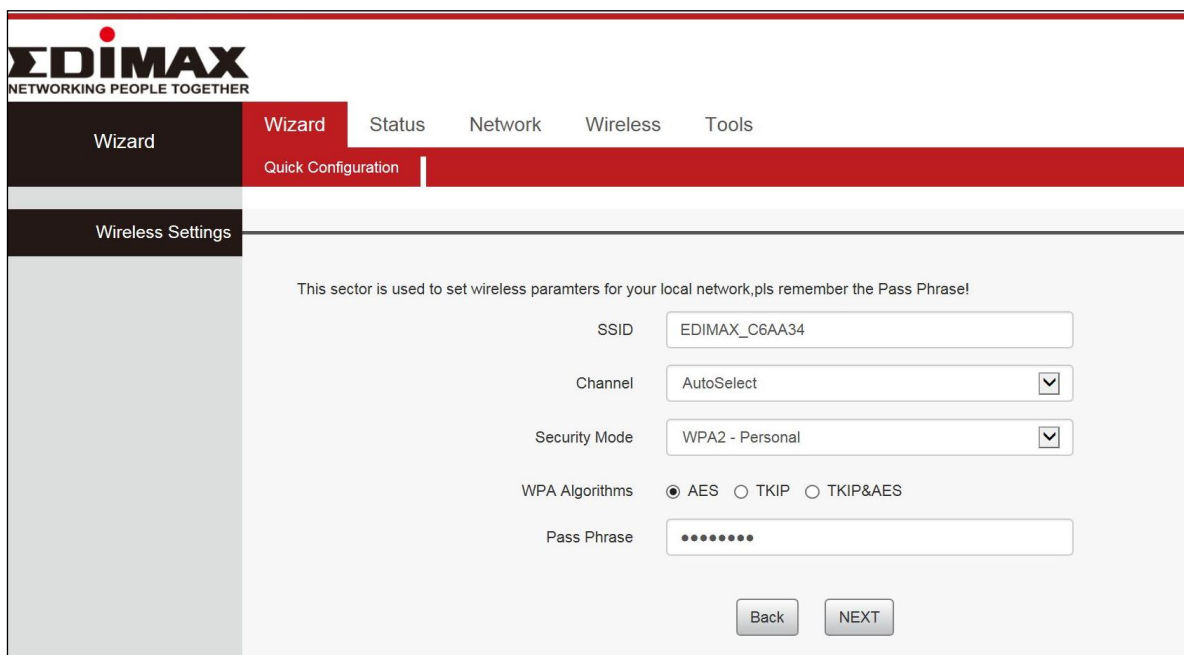

The screenshot shows the EDIMAX web interface at the 'Wireless Settings' step. The top navigation bar is the same as in the previous screenshot. The 'Wireless Settings' section is active. The main content area contains the text 'This sector is used to set wireless parameters for your local network,pls remember the Pass Phrase!' and several configuration fields: 'SSID' (EDIMAX_C6AA34), 'Channel' (AutoSelect), 'Security Mode' (WPA2 - Personal), 'WPA Algorithms' (AES selected), and 'Pass Phrase' (masked with dots). 'Back' and 'NEXT' buttons are at the bottom.

4. Please click “Save” to reboot the device and activate the configuration.

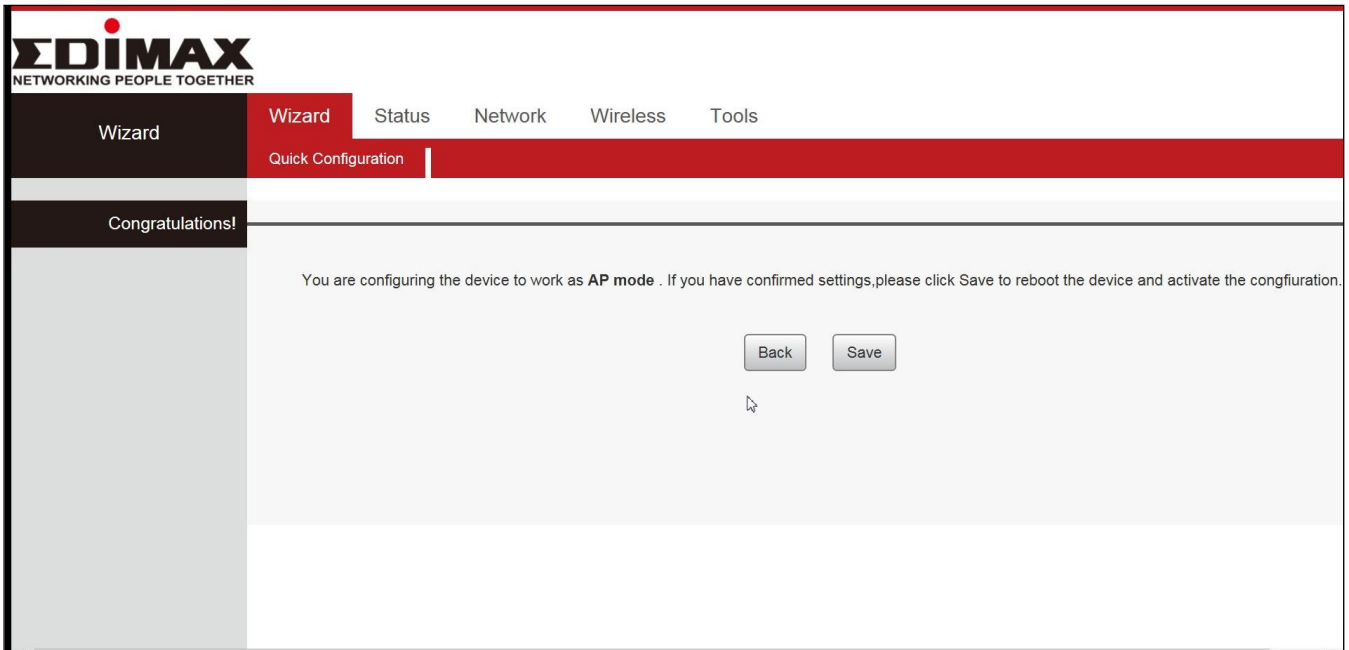

5. Please wait a moment until the BR-6428nS V5 is ready.

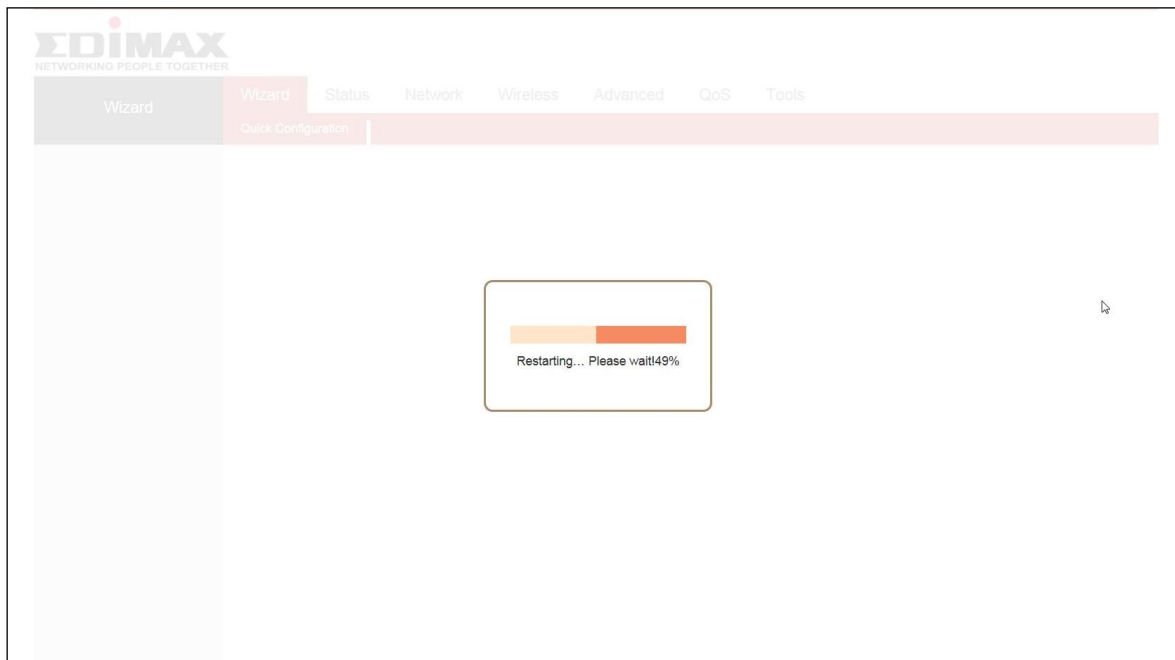

- 6.** When the setup is complete. Please close the browser window.

- 7.** The BR-6428nS V5 is working and ready for use. You can now connect to the device's new SSID. Please refer to [IV-2. Connecting to a Wi-Fi network](#) if you require more guidance.

II-5. WPS Setup

If your wireless device supports WPS (Wi-Fi Protected Setup) then you can use this method to connect to the BR-6428nS V5's Wi-Fi network.

- 1.** Press the **WPS button** on the BR-6428nS V5 for 1 – 3 seconds to activate WPS. The WPS LED will flash for two minutes to indicate that WPS is active.
- 2.** **Within two minutes**, press the WPS button on the **wireless device/client** to activate its WPS.
- 3.** The devices will establish a connection. Repeat for additional wireless devices.

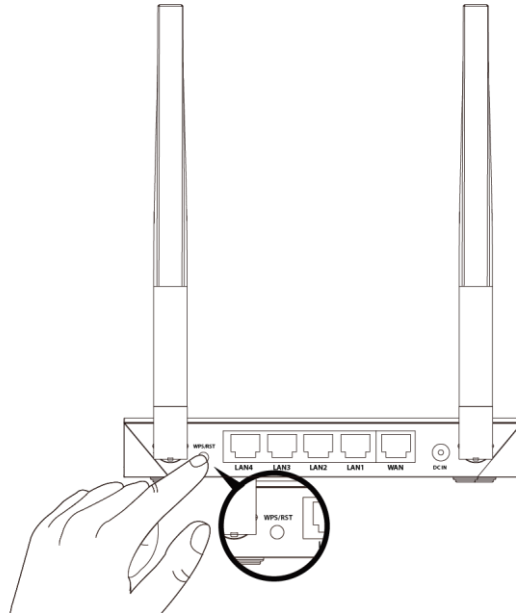

 ***Please check the instructions for your wireless device for how long you need to hold down its WPS button to activate WPS.***

II-6. Reset to Factory Default Settings

If you experience problems with your BR-6428nS V5, you can reset the device back to its factory settings. This resets **all** settings back to default.

- 1.** Press and hold the WPS/Reset button found on the back panel for at least 10 seconds, until the power LED begins to flash.
- 2.** Release the button when the power LED is **flashing**.
- 3.** Wait for the BR-6428nS V5 to restart. The BR-6428nS V5 is ready for setup when the power LED displays **on**.

III. *Browser Based Configuration Interface*

After you have setup the BR-6428nS V5 as detailed in **II. Installation** or the included **Quick Installation Guide**, you can use the browser based configuration interface to configure advanced settings.



Please ensure that your computer is set to use a dynamic IP address. Refer to [IV-1. Configuring your IP address](#) for more information.

III-1. Login

1. To access the browser based configuration interface enter <http://192.168.2.1> into the URL bar of a browser on a network device connected to the same Wi-Fi network as the BR-6428nS V5.

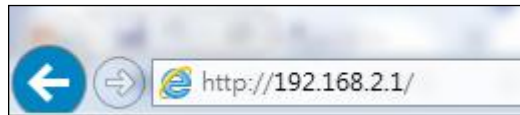

If you can not access <http://192.168.2.1>, connect the device to a computer using an Ethernet cable and try again.

2. You will be prompted for a username and password. The default username is “admin” and the default password is “1234”.

EDIMAX
NETWORKING PEOPLE TOGETHER

Language: English ▾

User Name:

Password:

3. Then click on the “Status” tab shown below. Use the top menu to navigate. For more information, refer to following chapters.

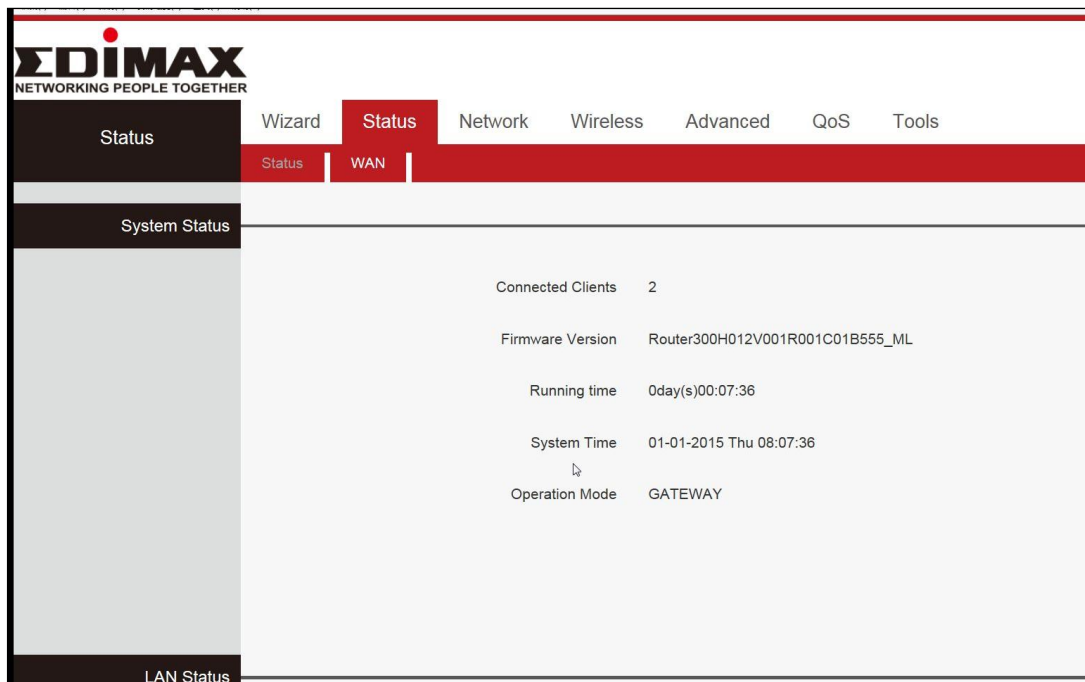



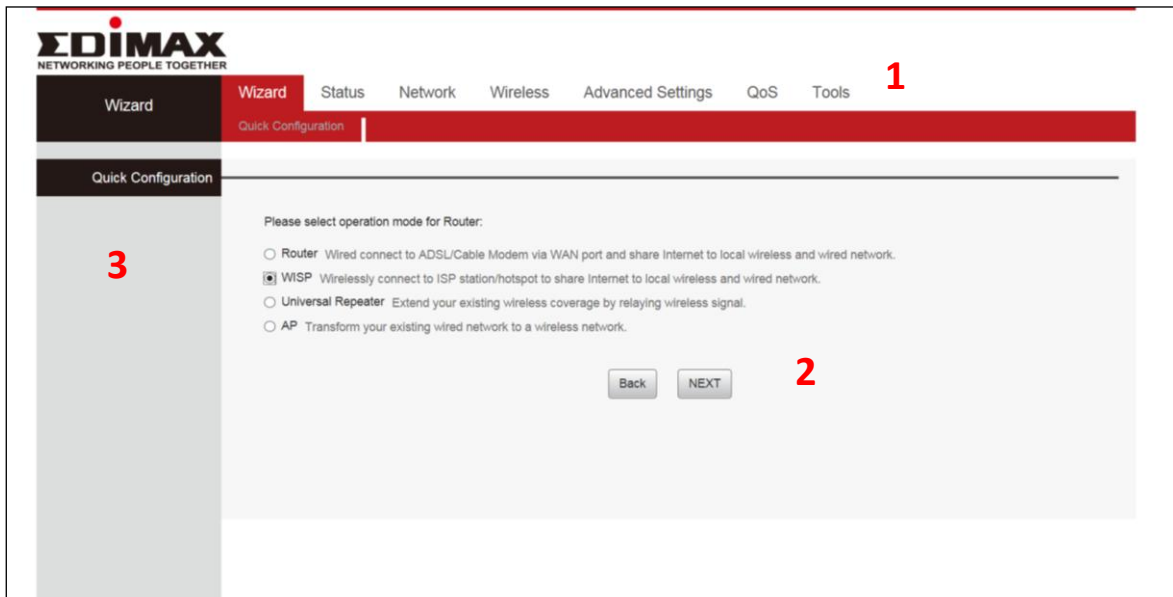

III-2. Main Menu

Main menu is consisted of three areas. User can navigate and configure BR-6428nS V5 via the main menu.

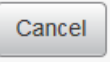

1	Top menu	User can easily Select functions in the navigation bar menu, Select the results displayed in the configuration section.
2	Configuration zone	Configure and view area.
3	Status	Current status

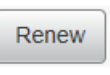
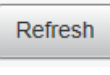
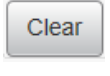
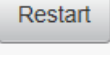
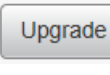
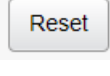
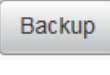
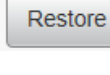
III-2-1. Commonly used web elements

Common elements	Description
	Click "Save" to save the current settings.
	Click "Cancel" to cancel the changes made.
	Click "Release" to release information and data.
	Click "Renew" to update the information.
	Click "Refresh" to update the information.
	Click "Clear" to clear/erase existing information.
	Click "Restart" to restart the device.
	Click "Upgrade" to update the firmware.
	Click "Reset" to reset the device.
	Click "Backup" to back up the router's configurations.
	Click "Restore" to restore the router's configurations.
	Click "Ping" to send ICMP Echo Request to a specified interface on the network and waiting for a reply.
	Click "Exit" to exit the current screen.

III-2-2. Setup Wizard

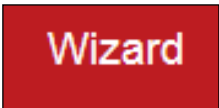

You can run the setup wizard again to reconfigure the basic settings of the device, or you can run a wizard to help you switch the device to a different operating mode. Select “Wizard” then click on “Quick Configuration” to begin.

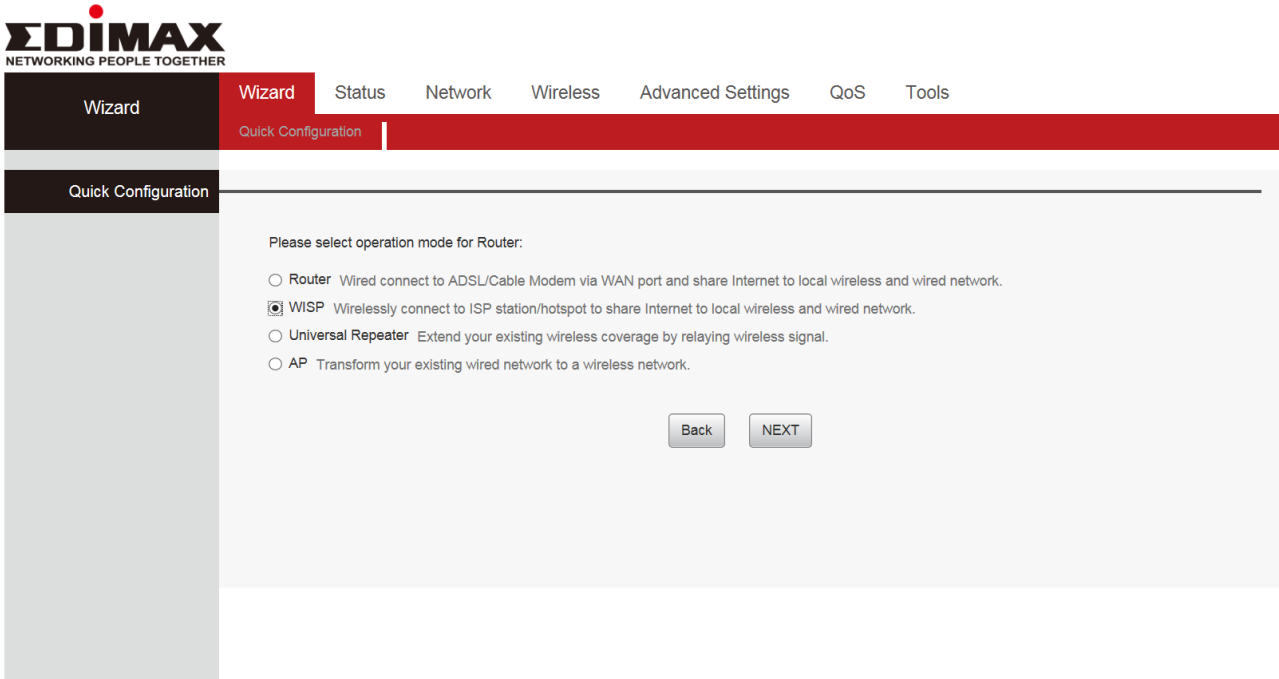

Wi-Fi Router	<i>The device connects to your modem and enables Internet (wireless and Ethernet) access on your network devices.</i>
WISP Mode	<i>The device connects wirelessly to your Wireless Internet Service Provider and provides 2.4GHz and/or 5GHz Internet (wireless and Ethernet) access for your network devices.</i>
Universal Repeater	<i>The device will act as a wireless range extender that will help you to extend your Wi-Fi network. The device acts as a client and AP at the same time. It uses its client function to connect to a root AP, and uses its AP function to service wireless clients within its coverage.</i>
Access Point	<i>The device connects to an existing router via Ethernet cable and provides Internet (wireless and Ethernet) access for your network devices.</i>

Switch to Router/AP/Universal Repeater/WISP

1. Follow the on-screen instructions to reset the device back to its factory default settings.
2. Please wait for a few moments before the device is restarted.

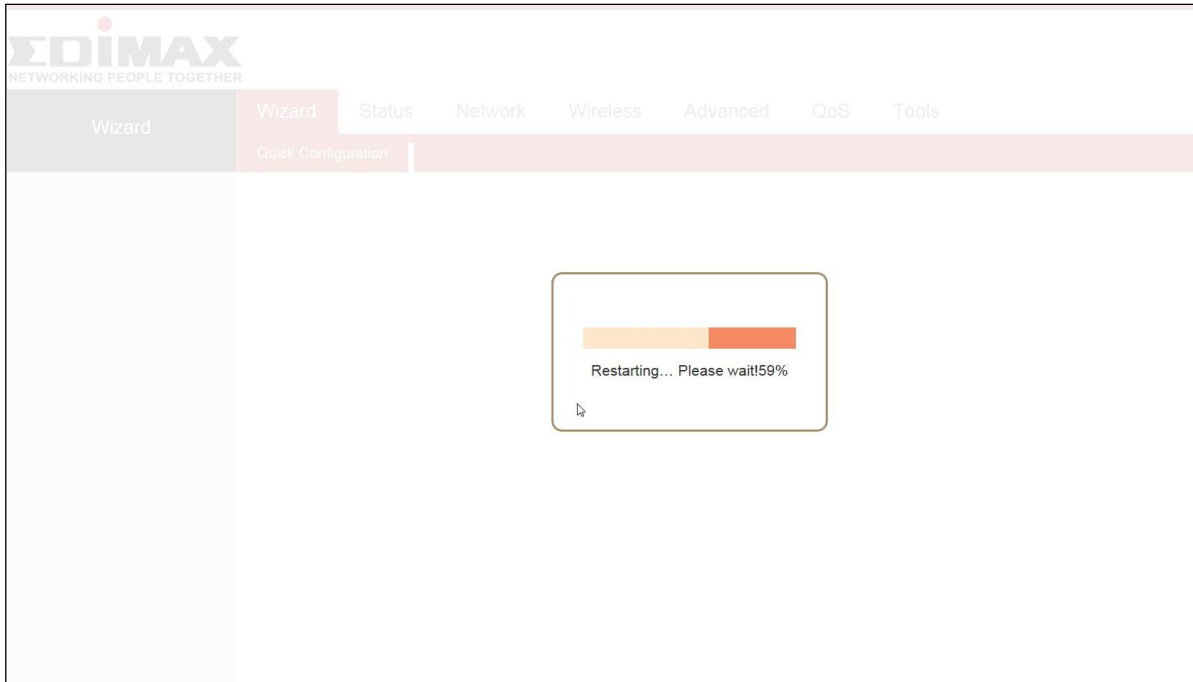

3. After the device has reset, the log in page will appear. Enter the log in information to proceed.



4. Follow the on-screen wizard to setup your device in a different mode.

III-2-3. Status

Status

The “Status” page displays basic system information about the device, arranged into four categories: System, LAN, Wireless and WAN.

The screenshot shows the EDIMAX web interface. The top navigation bar includes 'Wizard', 'Status', 'Network', 'Wireless', 'Advanced Settings', 'QoS', and 'Tools'. The 'Status' page is divided into three sections: System Status, LAN Status, and Wireless Status. The 'WAN' tab is selected in the top navigation bar.

Category	Parameter	Value
System Status	Connected Clients	2
	Firmware Version	Router300H012V001R001C01B571_EN
	Running time	0day(s)00:39:22
	System Time	01-01-2015 Thu 08:39:22
	Operation Mode	GATEWAY
LAN Status	IP Address	192.168.1.1
	Subnet Mask	255.255.255.0
	DHCP Server	Enable
	LAN MAC Address	00:16:FB:C6:AA:36
Wireless Status	SSID Name	EDIMAX_C6AA34
	BSSID	00:16:FB:C6:AA:34
	Channel	AutoSelect
	Security Mode	WPA2 - Personal



Screenshots displayed are examples. The information shown on your screen will vary depending on your configuration.

III-2-3-1. System Status

This page displays Connected Clients, Firmware Version, Running Time, System Time and operation mode.

System Status	
Connected Clients	1
Firmware Version	Router300H012V001R001C01B571_EN
Running time	0day(s)00:22:01
System Time	20-11-2018 Tue 09:25:30
Operation Mode	GATEWAY

Connected Clients	Displays the number of DHCP clients.
Firmware Version	Firmware Version.
Running time	Displays the time duration indicating how long the router has been up since startup. Up time is recounted and renewed upon power off.
System Time	Current system time on this device. The device automatically synchronizes the system time with Internet time servers.
Operation Mode	Displays the current operation mode

III-2-3-2. LAN Status

LAN Status	
IP Address	192.168.2.1
Subnet Mask	255.255.255.0
DHCP Server	Enable
LAN MAC Address	00:16:FB:C6:AA:36

IP Address	The Router's LAN IP Address (not your PC's IP address).
Subnet Mask	The Router's LAN subnet mask.
DHCP Server	The status of DHCP server.
LAN MAC Address	The router's physical address.

III-2-3-3. Wireless Status

Wireless Status	
	SSID Name edimax_24G_24G_34 BSSID 00:16:FB:C6:AA:34 Channel AutoSelect Security Mode Disable

SSID Name	The name of Wireless.
SSID	The MAC Address of Wireless.
Channel	The Channel of Wireless.
Security Mode	Encryption schemes.

III-2-3-4. WAN Status

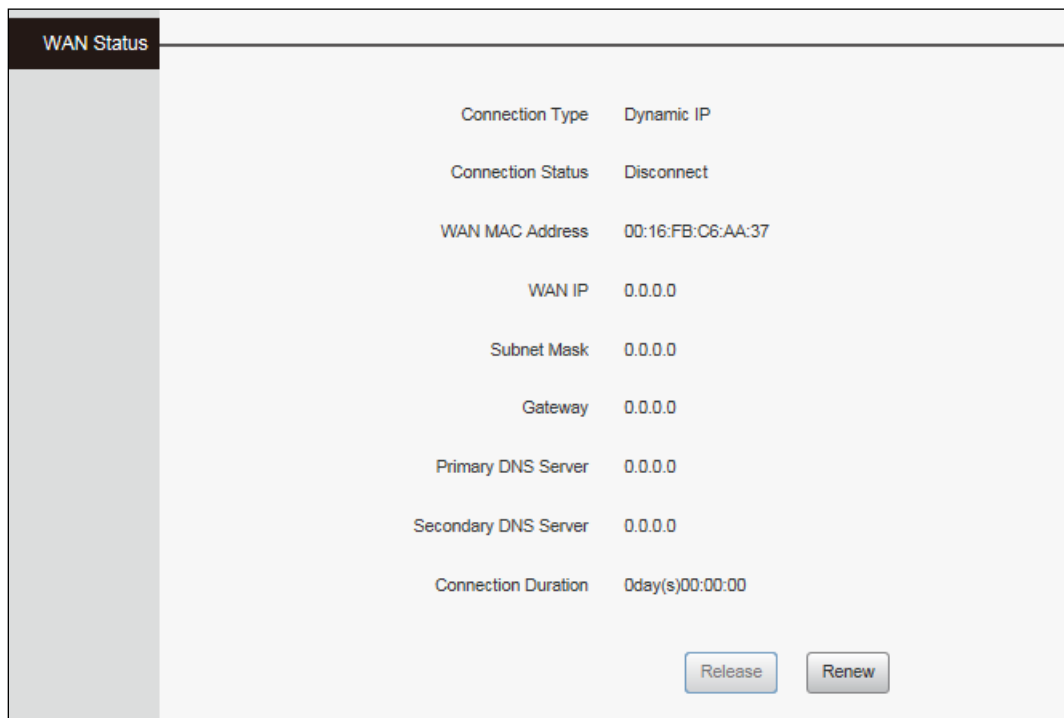

Connection Type	It displays the current access mode of WAN port.
Connection Status	The network connection status.
WAN MAC Address	MAC address of your ISP's router to see.
WAN IP	IP address obtained from ISP.
Subnet Mask	Obtained from ISP.
Gateway	Obtained from ISP.
Primary DNS Server	Obtained from ISP.
Secondary DNS Server	Obtained from ISP.
Connection Duration	Access method for dynamic IP or PPPOE server and router and ISP connection is properly timed.

III-3. Network

Click “Network” to enter the Network setup web page, in this page you can set “WAN”, “WAN Speed”, “MAC Cloning”, “DNS Settings”, “WAN Security”, “LAN Settings”, “DHCP” and “Address Reservation”.

III-3-1. WAN Settings

WAN Settings configure the Internet access and support Static IP mode, Dynamic IP (DHCP), PPPOE, L2TP and PPTP.

III-3-1-1. WAN Settings- Dynamic IP

Click “Network”, select “WAN”, then elect Connection Type to “Dynamic IP” and finally click “Save” to confirm.

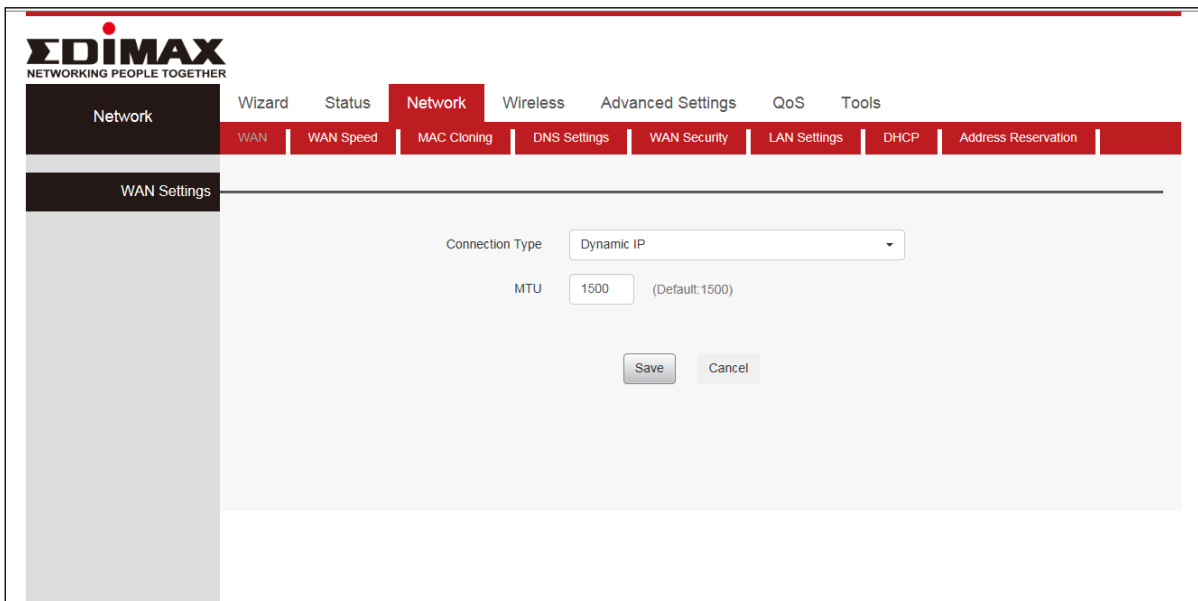

Connection Type	It displays the routers mode.
MTU	Maximum Transmission Unit. It is the size of the largest data packet that can be sent over the network. The default value is 1500.

III-3-1-2. WAN Settings- Static IP

Click “Network”, Select “WAN”, Select Connection Type “Static IP”. Then enter IP, Subnet Mask, Gateway, MTU and DNS. Finally, click “Save” to confirm.

The screenshot shows the EDIMAX web interface. The top navigation bar includes 'Wizard', 'Status', 'Network' (selected), 'Wireless', 'Advanced Settings', 'QoS', and 'Tools'. Below this, a sub-menu contains 'WAN' (selected), 'WAN Speed', 'MAC Cloning', 'DNS Settings', 'WAN Security', 'LAN Settings', 'DHCP', and 'Address Reservation'. The main content area is titled 'WAN Settings' and contains the following fields:

- Connection Type: Static IP (dropdown menu)
- IP Address: 0.0.0.0
- Subnet Mask: 0.0.0.0
- Gateway: 0.0.0.0
- Primary DNS Server: 0.0.0.0
- Secondary DNS Server: 0.0.0.0
- MTU: 1500 (Default: 1500)

At the bottom right, there are 'Save' and 'Cancel' buttons.

Connection Type	Specify a connection type: Static IP mode, Dynamic IP (DHCP), PPPOE, L2TP or PPTP
IP Address	Input the IP address assigned by your ISP here.
Subnet Mask	Input the subnet mask assigned by your ISP here.
Gateway	Input the default gateway assigned by your ISP here. Some ISPs may call this “Default Route”.
Primary DNS Server	Obtained from ISP.
Secondary DNS Server	Obtained from ISP.
MTU	Enter the maximum transmission unit (MTU) value of your network connection. The default value is 1400.

III-3-1-3. WAN Settings- PPPOE

Click “Network”, select “WAN”, then select Connection Type “PPPOE”. Enter the ISP login User Name and the ISP login Password. Finally, click “Save” to confirm. To confirm the configuration details, click “System Status” > “WAN Status”.

The screenshot shows the EDIMAX web interface. The top navigation bar includes 'Wizard', 'Status', 'Network' (selected), 'Wireless', 'Advanced Settings', 'QoS', and 'Tools'. Below this is a sub-menu with 'WAN' (selected), 'WAN Speed', 'MAC Cloning', 'DNS Settings', 'WAN Security', 'LAN Settings', 'DHCP', and 'Address Reservation'. The main content area is titled 'WAN Settings' and contains the following fields:

- Connection Type: A dropdown menu with 'PPPOE' selected.
- UserName: A text input field with a red error message 'this is required' below it.
- Password: A text input field with a red error message 'this is required' below it.
- MTU: A text input field with '1492' and '(Default:1492)' next to it.
- Service Name: A text input field.

At the bottom of the form are 'Save' and 'Cancel' buttons.

Connection Type	Specify a connection type: Static IP mode, Dynamic IP (DHCP), PPPOE, L2TP or PPTP
User Name	Input the user name assigned by your ISP here.
Password	Input the password assigned by your ISP here.
MTU	Enter the maximum transmission unit (MTU) value of your network connection. The default value is 1492.
Service Name	Enter the host name of your computer here If required.

III-3-1-4. WAN Settings- PPTP

Select “PPTP” if your ISP is providing you Internet access via PPTP (Point-to-Point Tunneling Protocol).

Click “Network”, select “WAN”, then select Connection Type “PPTP”. Enter the PPTP Server, User name, Password, Address Mode and MTU. Finally, click “Save” to confirm.

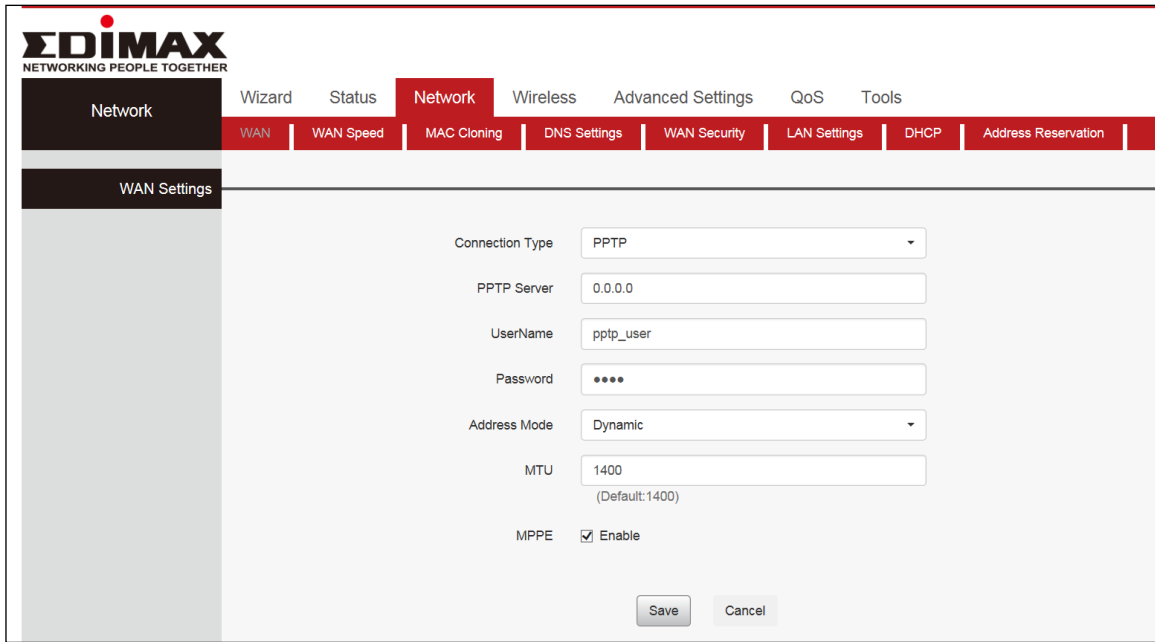

PPTP Server	Input the PPTP gateway assigned by your ISP here.
User Name	Input the user name assigned by your ISP here.
Password	Input the password assigned by your ISP here.
MTU	Enter the maximum transmission unit (MTU) value of your network connection. The default value is 1400.
Connection Type	Specify a connection type: Static IP mode, Dynamic IP (DHCP), PPPOE, L2TP or PPTP
Address Mode	Specify the dynamic or static address mode
MPPE	MPPE provides data security for the PPTP connection that is between the VPN client and the VPN server.

III-3-1-5. WAN Settings- L2TP

Select “L2TP” if your ISP is providing you Internet access via L2TP (Layer 2 Tunneling Protocol).

Click “Network”, select “WAN”, then select Connection Type “L2TP”. Enter the L2TP Server, User name, Password, Address Mode and MTU. Finally, click “Save” to confirm.

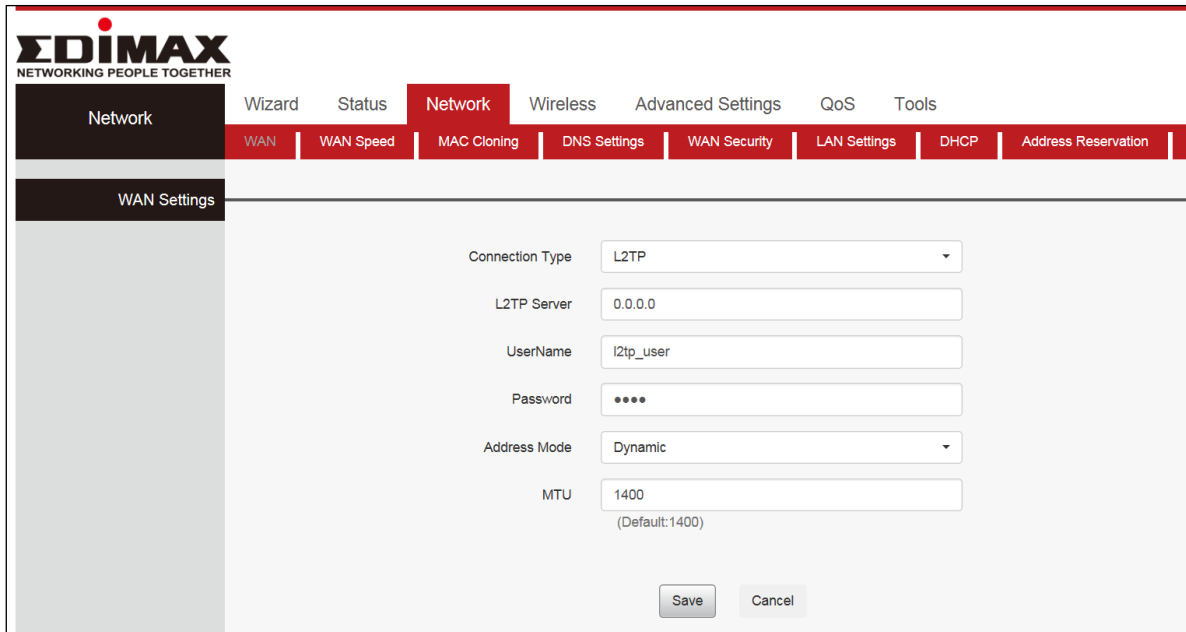

The screenshot shows the EDIMAX web interface for WAN Settings. The navigation menu includes Wizard, Status, Network (selected), Wireless, Advanced Settings, QoS, and Tools. The sub-menu includes WAN (selected), WAN Speed, MAC Cloning, DNS Settings, WAN Security, LAN Settings, DHCP, and Address Reservation. The WAN Settings page displays the following configuration fields:

- Connection Type: L2TP (dropdown menu)
- L2TP Server: 0.0.0.0 (text input)
- UserName: l2tp_user (text input)
- Password: •••• (password input)
- Address Mode: Dynamic (dropdown menu)
- MTU: 1400 (text input, with a note "(Default:1400)")

Buttons for "Save" and "Cancel" are located at the bottom of the form.

Connection Type	Specify a connection type: Static IP mode, Dynamic IP (DHCP), PPPOE, L2TP or PPTP
L2TP Server	Input the L2TP gateway assigned by your ISP here.
UserName	Input the user name assigned by your ISP here.
Password	Input the password assigned by your ISP here.
Address Mode	Specify the dynamic or static address mode
MTU	Enter the maximum transmission unit (MTU) value of your network connection. The default value is 1400.

III-3-2. WAN Speed

Click “Network”, select “WAN Speed”, then select Speed Mode type. Finally, click “Save” to confirm.

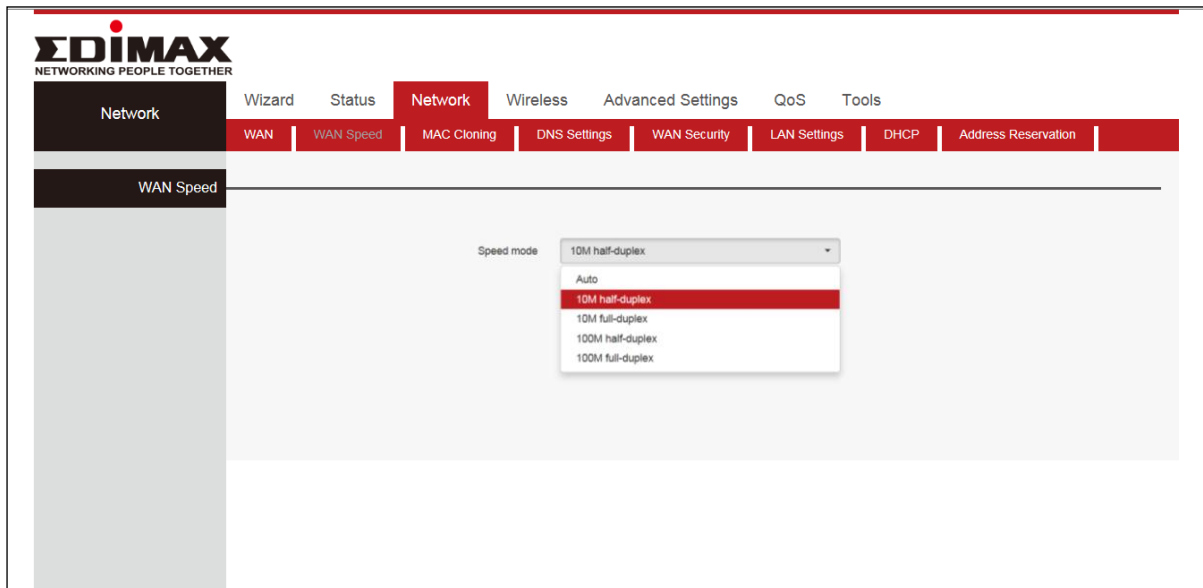

Speed Mode

Set the value to match with the status. Modes include Auto, 10M half-duplex, 10M full-duplex, 100M half-duplex, 100M full-duplex

III-3-3. MAC Cloning

Some ISPs (Internet Service Providers) require end-user's MAC address to access their network. This feature copies your current PC's MAC address to the router.

Click “Network”, then “MAC Cloning”. You can set this page from three methods :

1. To Restore to Factory Default MAC

- a. Click “Restore to factory Default MAC”
- b. Click Save to save your settings.

2. To clone the MAC address of the computer that you are now using to the router

- a. Click Clone My PC's MAC Address.
- b. Click Save to save your settings.

3.To manually enter the MAC address allowed by your ISP:

- a.Enter the MAC address allowed by your ISP.
- b.Click Save to save your settings.

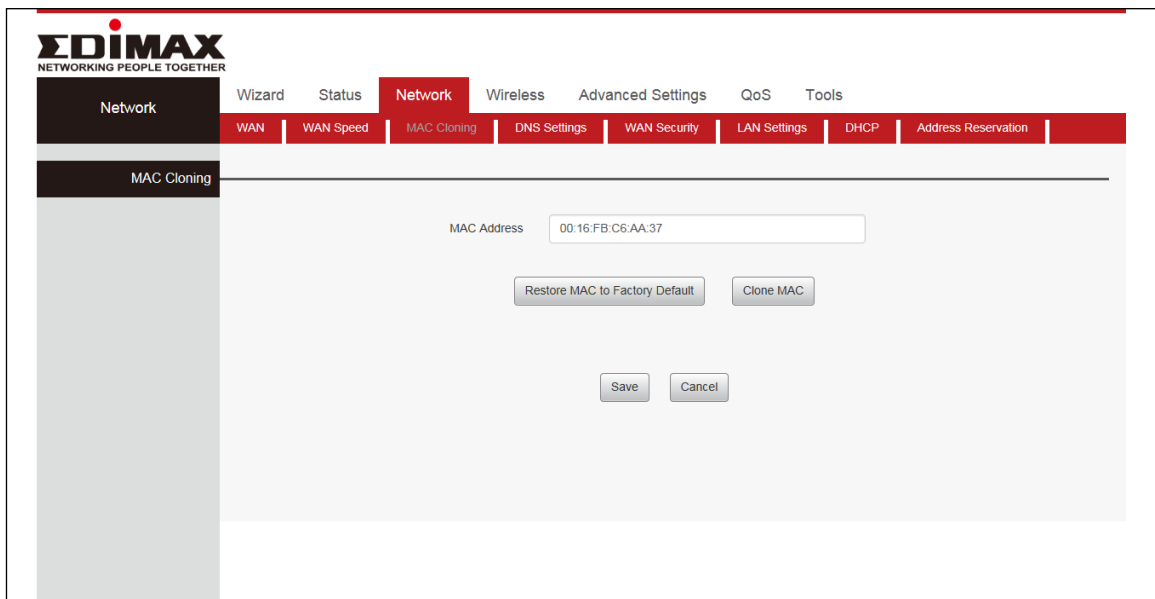

MAC Address	The computer or broadband modem authorized by your ISP.
Restore to Factory Default MAC	Reset the router's WAN MAC to factory default.
Clone MAC	copies the MAC address of the computer that you are now using to the router

III-3-4. DNS Settings

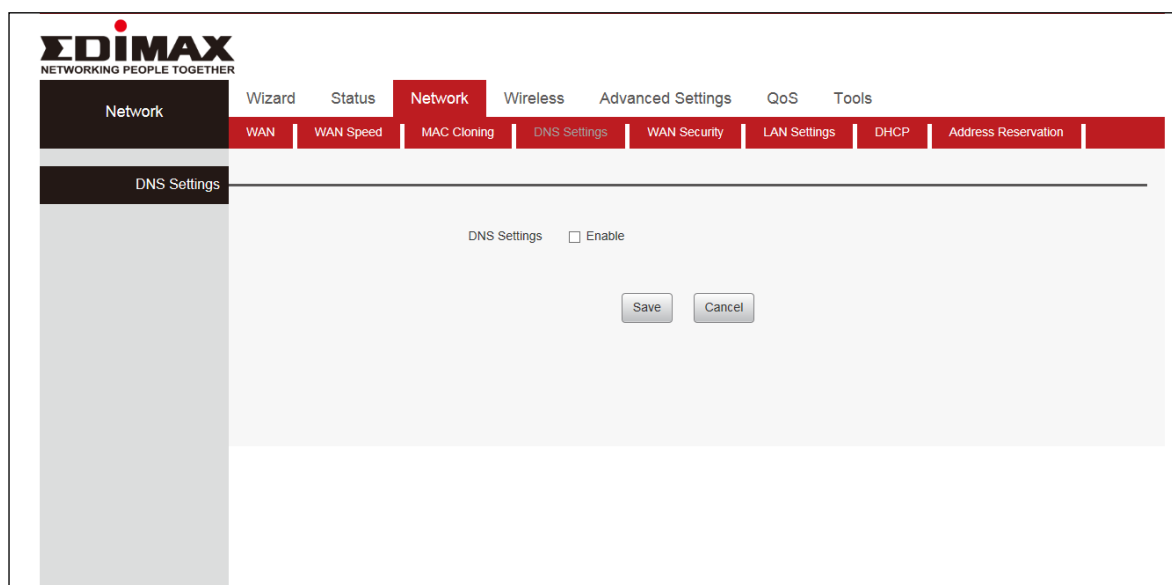

III-3-5. WAN Security

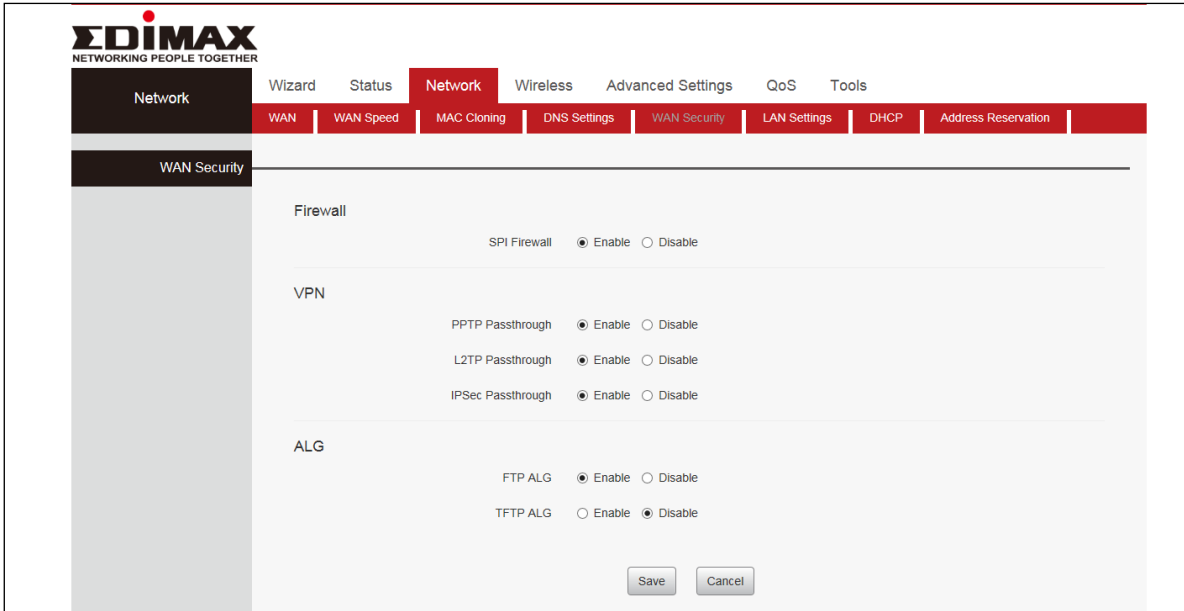

SPI firewall	Enable or disable the stateful packet inspection (SPI) firewall.
VPN	Supports enable/disable PPTP passthrough, L2TP passthrough and IPsec Passthrough
ALG	Application Layer Gateway (ALG) is a network security gateway which supports specific network applications such as gaming and instant messaging. ALG enables these applications to communicate with their server. Supports enable/disable FTP ALG and TFTP ALG

III-3-6. LAN Settings

This page is to configure the basic parameters for LAN ports. This IP address is to be used to access the device's settings through a web browser. Be sure to make a note of any changes you apply to this page.

Click "Network", select "LAN Settings". Enter IP Address, Subnet Mask. Then click "Save" and wait for the router reboot automatically.

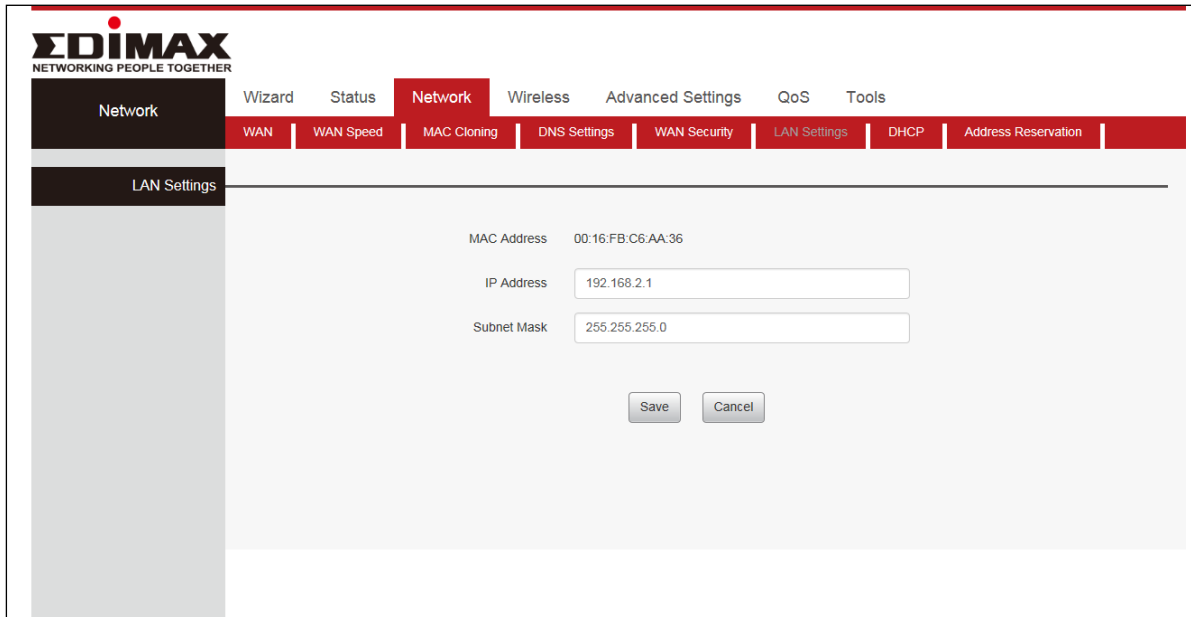

MAC Address	Displays the Router's LAN MAC address.
IP Address	Displays the Router's LAN IP address.
Subnet Mask	Displays the Router's LAN subnet mask.



The router's LAN IP address and WAN IP address cannot be on the same IP segment. If not, the router will not be able to access Internet.



Be sure to make a note of any changes you apply to this page. If you change the LAN IP address of the router, you have to open a new connection to the new IP address and log in again. Also, you have to set the default gateway addresses of all LAN PCs to this new IP address.

III-3-7. DHCP

DHCP (Dynamic Host Configuration Protocol) is a protocol used to provide quick, automatic, and central management for the distribution of IP addresses within a network.

DHCP is also used to configure the proper subnet mask, default gateway, and DNS server information on the device. Click “Network” and select “DHCP”.

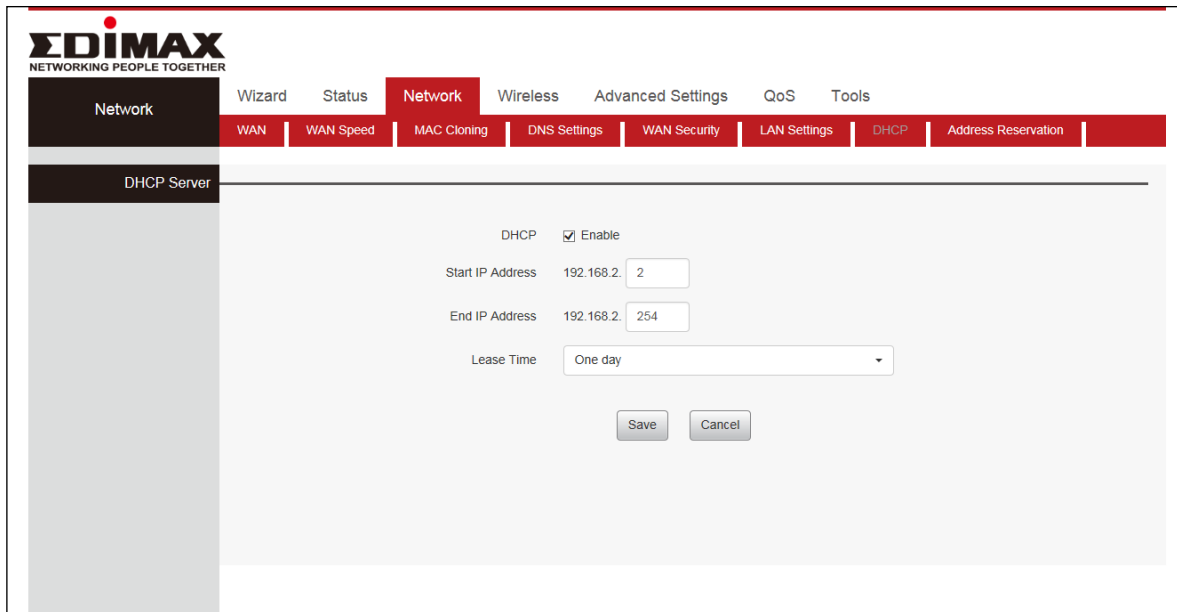

DHCP Server	Select whether enable or disable the DHCP server feature.
Start IP Address	Part of the same IP address subnet as the router's LAN IP address.
End IP Address	Part of the same IP address subnet as the router's LAN IP address.
Lease Time	The length of the IP address lease before it is refreshed.

III-3-8. Address Reservation

This function allows you to learn whether there are unauthorized accesses by viewing the client list. Also, you can specify a reserved IP address for a PC in the LAN. That PC will always receive the same IP address each time when it accesses the DHCP server. Reserved IP addresses could be assigned to servers that require permanent IP settings.

Click “Network” and select “Address Reservation”. Enter the IP Address and MAC Address. Click “Add” add to the DHCP list, click “Save” to save your settings, then click “Refresh” to update the related DHCP client information.

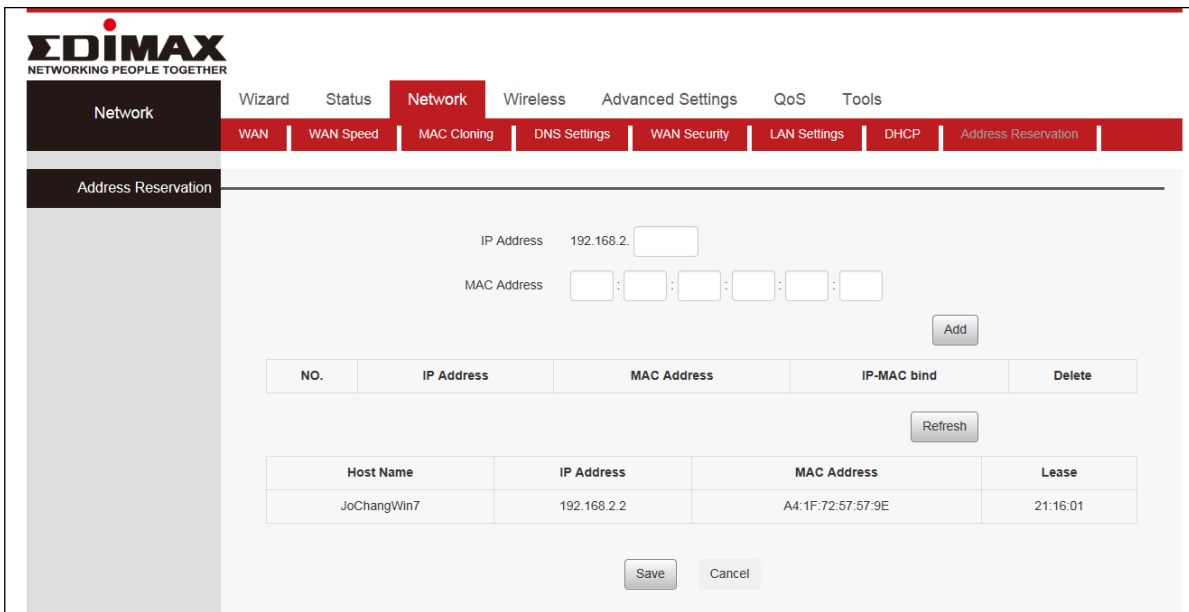

III-4. Wireless

The “Wireless” menu allows you to configure SSID and security settings for your Wi-Fi network along with a guest Wi-Fi network. Click “Wireless” to enter the configure page , here you can configure “Wireless Settings”, “Wireless Security”, “Multi SSID”, “WPS Settings”, “Wireless MAC Filtering”, “Wireless Statistics”.

III-4-1. Wireless Settings

Click “Wireless”, select “Basic Settings”. Then enable Wireless, select Network Mode. Enter SSID name, select “Channel” and select “Channel BandWidth”.

The screenshot shows the EDIMAX web interface for wireless settings. The 'Wireless' tab is active, and the 'Basic Settings' section is expanded. The configuration options are as follows:

- Wireless:** Enable
- Network Mode:** Automatic(802.11b/g/n)
- SSID:** edimax_24G_24G_34
- Broadcast(SSID):** Enable Disable
- BSSID:** 00:16:FB:C6:AA:34
- Channel:** AutoSelect
- Channel BandWidth:** 20 20/40
- Extension Channel:** Auto
- TX Power:** High Medium Low
- WMM Capable:** Enable Disable
- APSD Capable:** Enable Disable

Buttons for 'Save' and 'Cancel' are located at the bottom of the form.

Wireless	Enable/Disable wireless connection
Network Mode	<p>Select a correct mode according to your wireless clients.</p> <ul style="list-style-type: none"> ● 11b: This network mode delivers wireless speed up to 11Mbps and is only compatible with 11b wireless clients. ● 11g: This network mode delivers wireless speed up to 54Mbps and is only compatible with 11g wireless clients. ● 11b/g mixed: This network mode delivers wireless speed up to 54Mbps and is compatible with 11b/g wireless clients. ● 11b/g/n mixed: This network mode delivers wireless speed up to 300Mbps and is compatible with 11b/g/n wireless clients
SSID	The unique name of the wireless network and can be modified
Broadcast (SSID)	Select "Enable" to enable the router' SSID to be scanned by wireless devices. The default is enabled. If you disable it, the wireless devices must know the SSID for communication.

BSSID	The MAC address of the device's wireless interface.
Channel	The currently used channel by the router. Select an effective channel of the wireless network. The default is AutoSelect.
Channel Bandwidth	Select an appropriate channel bandwidth to enhance the wireless performance. Select 20/40M when the network has 11b/g/n to promote its throughput.
Extension Channel	The extension channel can either be "above" or "below" the control channel, if you feel you are not getting appropriate throughput, you may check specific extension channels for improvements.
Tx Power	Set the power output of the wireless radio. You may not require 100% output power. Setting a lower power output can enhance security since potentially malicious/unknown users in distant areas will not be able to access your signal.
WMM Capable	WMM (Wi-Fi Multimedia) technology can improve the performance of certain network applications, such as audio/video streaming, network telephony (VoIP) and others. When WMM is enabled, the device will prioritize different kinds of data and give higher priority to applications which require instant responses for better performance.
APSD Capable	Automatic Power Save Delivery (APSD) enable/Disable the use of auto power-saved service



It is advisable to only change the SSID (name of the network) and channel and leave other items unchanged.

III-4-2. Wireless Security

The wireless security function can prevent others from connecting to your wireless network and using the network resources without your consent. Meanwhile, you can also block illegal users from intercepting or intruding your wireless network. Click "Wireless", Select "Wireless Security" and choose security modes, Disable, WPA2 – Personal and Mixed WPA/WPA2 – Personal.

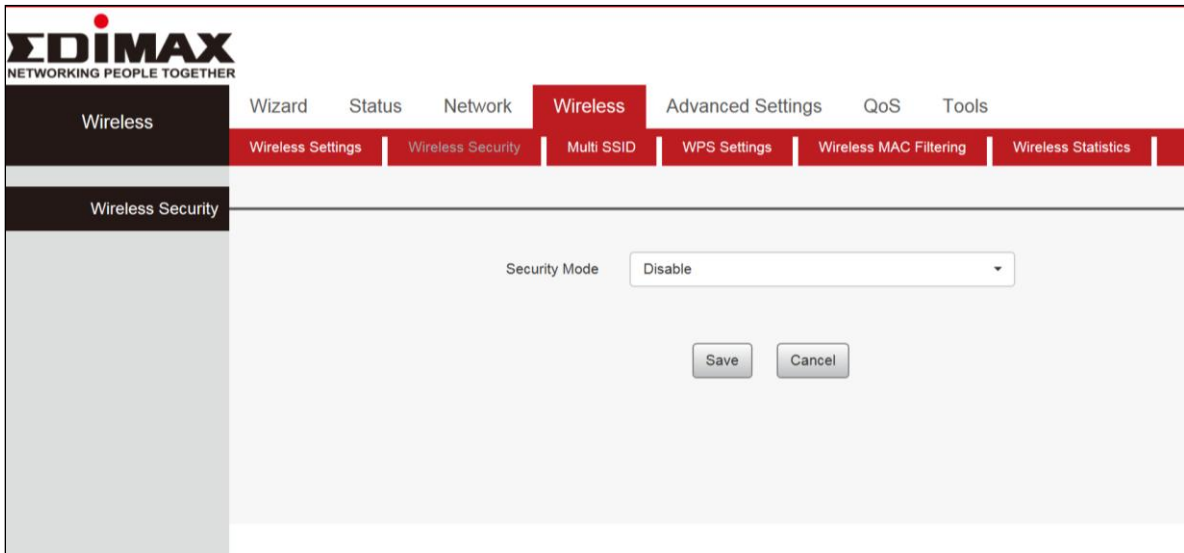

Disable	Disable this function.
WPA2 – Personal	Support AES, TKIP and TKIP+AES cipher types.
Mixed WPA/WPA2 – Personal	Both WPA-Personal and WPA2-Personal secured wireless clients can join your wireless network.

III-4-3. Multi SSID

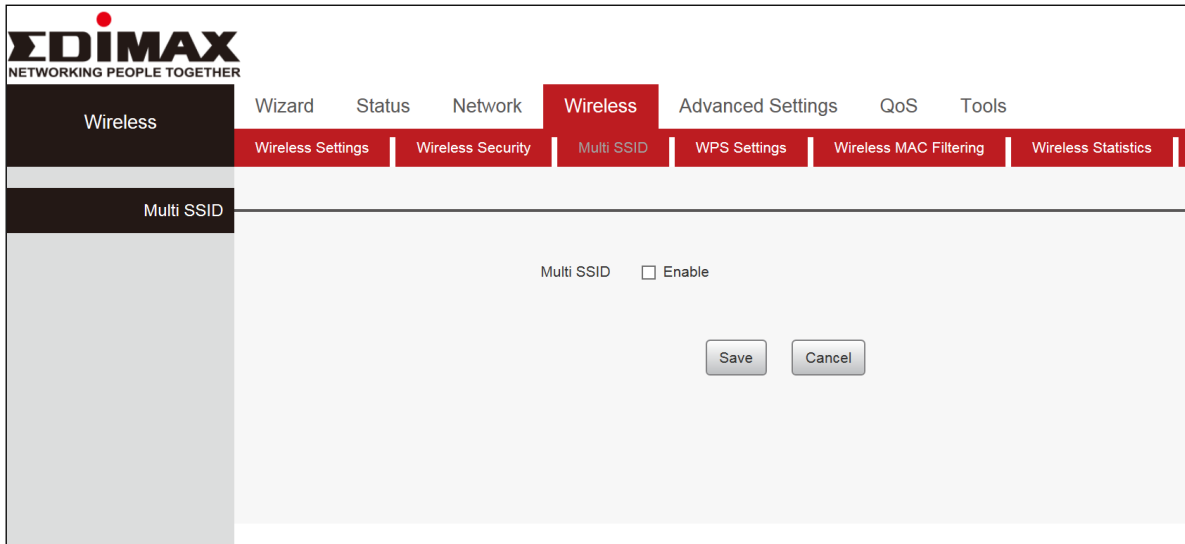

Multi SSID	Enable/ Disable multiple wireless networks to provide different security and VLAN groups.
-------------------	---

III-4-4. WPS Settings

Click “Wireless”, Select “WPS Settings”

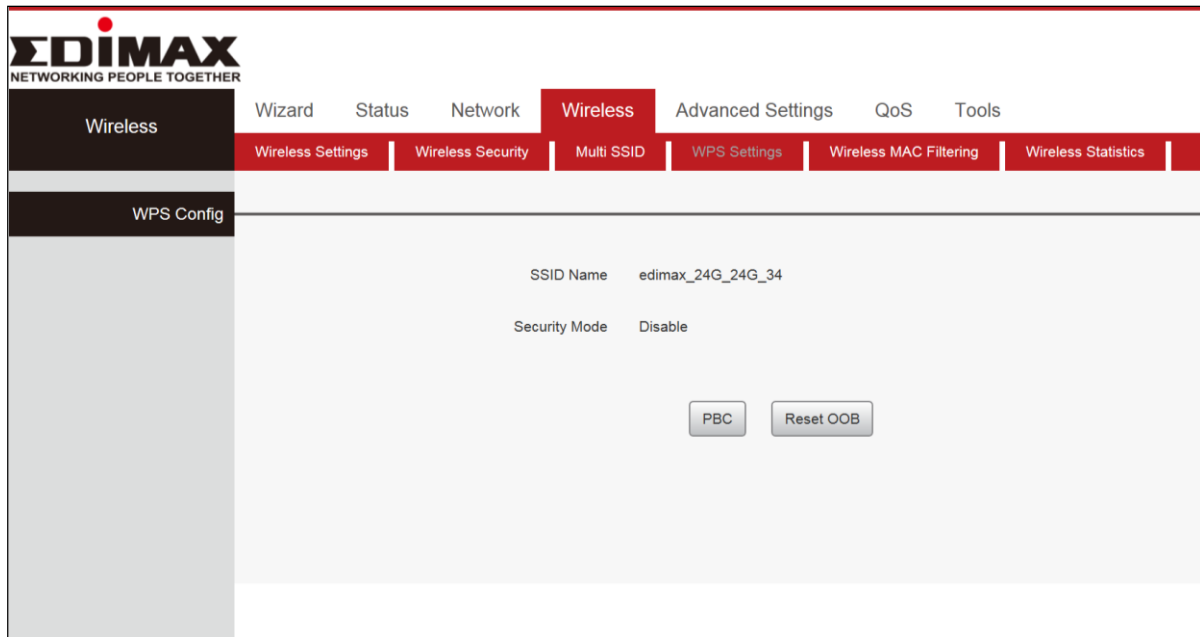

ResetOOB	The router wireless SSID and safe mode are restored to default mode. Use WPS to reset the SSID, Encryption and password, after the completion of the reset, the router's SSID is in factory default setting and safe mode is unencrypted.
PBC	Using routers and physical or logical button on a wireless device to connect WPS.
SSID Name	Name of SSID.
Security Mode	Displays the security mode selected.

III-4-5. Wireless MAC Filtering

This function permits or forbids specified clients to access the wireless network based on MAC Address. If a device which is not on the list of permitted MAC addresses attempts to connect to the BR-6428nS V5, it will be denied.

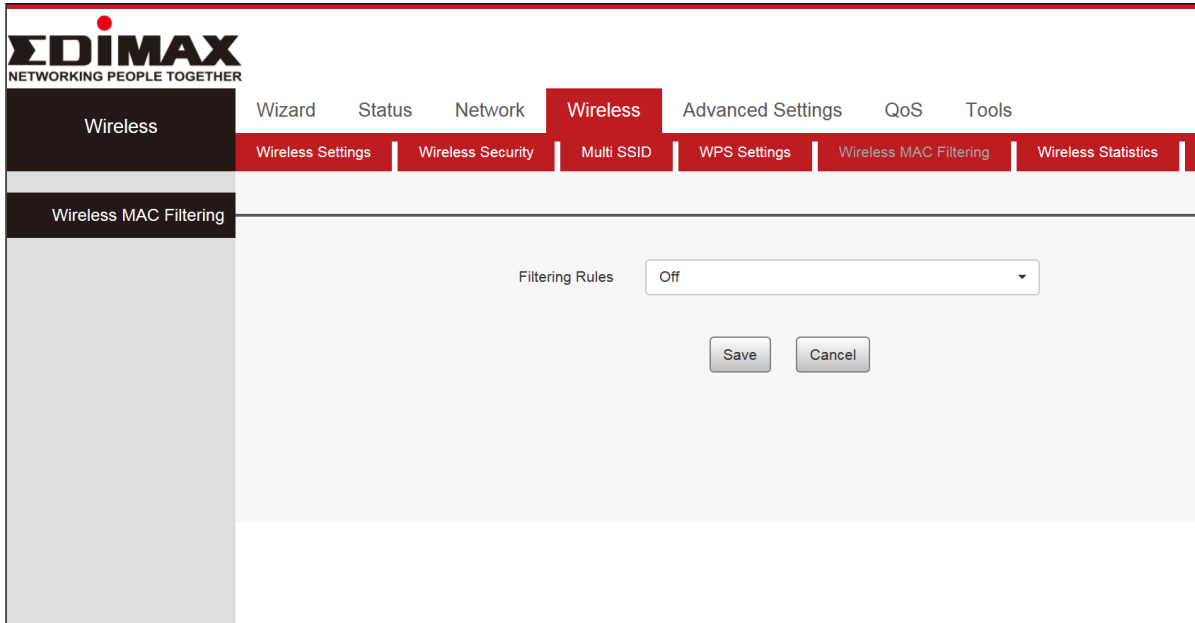

Filtering Rules

- Select “Off” to allow all wireless clients to join your wireless network.
- Select “Allow” allow ONLY the specified wireless clients to join your wireless network.
- Select “Block” block ONLY the specified wireless clients to join your wireless network.



Up to 10 wireless MAC addresses can be configured

III-4-6. Wireless Statistics

This page shows the current wireless access list Click “Refresh” to update.

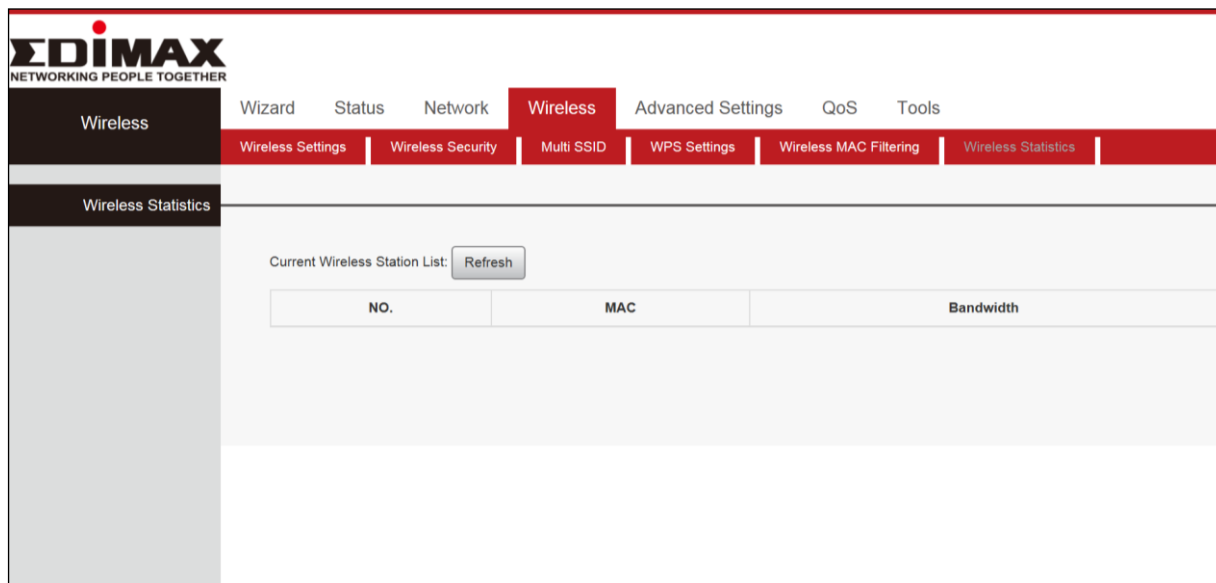

No.	Number of connected wireless clients
MAC	MAC address
Bandwidth	The channel bandwidth instead of wireless connection rate.
Refresh	Refresh the current wireless station list

III-5. Advanced Settings

Click “Advanced Settings” to enter the configure page, here you can configure “URL Filtering”, “Virtual Server”, “DMZ”, “DDNZ”, “Remote Management”, “WAN Ping”, “Static Routing” and “Routing Table”.

III-5-1. URL Filtering

This function sets URL filtering access. If you want to enable this function, please activate the checkbox. Select one policy from the drop-down menu and enter a policy name in the field. Of course, you can set the access restriction in details (e.g. the fixed IP range, URL, times and days). Note: When time is 0:0~0:0, it express 24 hours. Click “Advanced Settings”, then “URL Filtering” to configure this function.

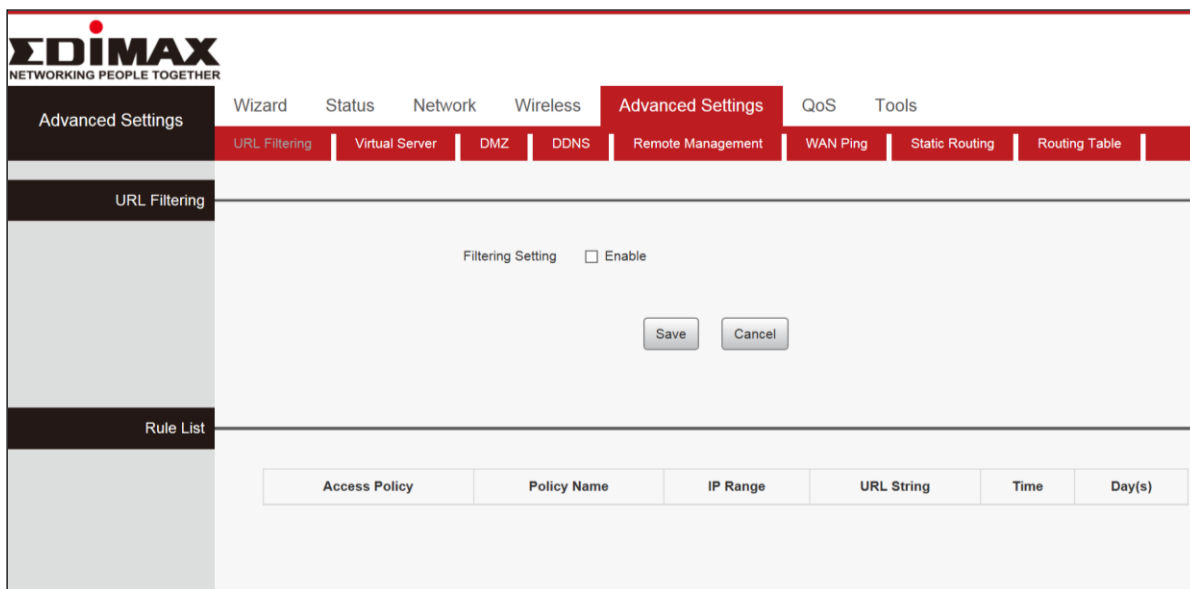

Filering Settings	Enable/Disable the filtering rules
Policy Name	Enter a name for rule for reference/identification.
Access Policy	Up to 10 filter rules can be configured
IP Range	Enter the start and End IP address
URL String	Enter the URL or keyword to be blocked.
Time	Specify the blocking time, it is expressed in 24 hours.
Day(s)	Specify which day of the week or everyday.

URL Filter Application Example:

To prevent your home PC (192.168.1.100) from accessing “YouTube” from 8:00 to 18:00 during working days: Monday- Friday.

- 1.** Enter a Policy Name
- 2.** Enter the Start IP and End IP here for example:192.168.1.100
- 3.** Enter part of or the entire domain name of the web site you wish to restrict. Separate different domain names or domain name key words with a comma, for example, "YouTube, Hollywood.com"
- 4.** Select time and day
- 5.** Click “Save” to save your settings.

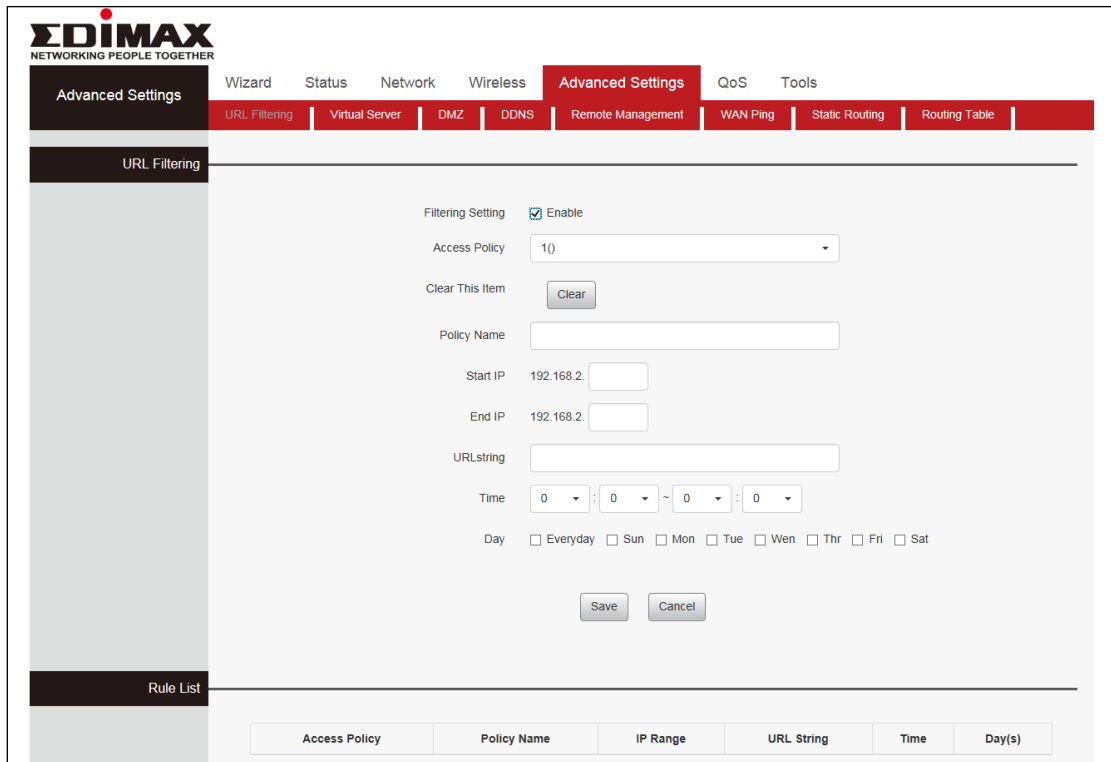

III-5-2. Virtual Server

You want to share resources on your PC with your friends who are not in your LAN. But, by default, the router's firewall blocks inbound traffic from the Internet to your computers except replies to your outbound traffic. You can use the Port Forwarding feature to create exceptions to this rule so that your friends can access these files from external networks.

When accessing your PC from Internet, type "protocol://xxx.xxx.xxx.xxx:port number" into your browser's address or location field. The protocol and port are the ones used by the service and "xxx.xxx.xxx.xxx" is the WAN IP address of your router. For example, a FTP server uses the ftp protocol and 21 (standard port number). Click "Advanced Settings" and select "Virtual Server" to access this feature.

ID	Start Port-End Port	To IP Address	Protocol	Enable	Delete
1.	<input type="text"/>	192.168.2. <input type="text"/>	TCP	<input type="checkbox"/>	<input type="checkbox"/>
2.	<input type="text"/>	192.168.2. <input type="text"/>	TCP	<input type="checkbox"/>	<input type="checkbox"/>
3.	<input type="text"/>	192.168.2. <input type="text"/>	TCP	<input type="checkbox"/>	<input type="checkbox"/>
4.	<input type="text"/>	192.168.2. <input type="text"/>	TCP	<input type="checkbox"/>	<input type="checkbox"/>
5.	<input type="text"/>	192.168.2. <input type="text"/>	TCP	<input type="checkbox"/>	<input type="checkbox"/>
6.	<input type="text"/>	192.168.2. <input type="text"/>	TCP	<input type="checkbox"/>	<input type="checkbox"/>

Well-known Service Port: DNS(53) 1

ID	Number of connected devices
Start Port–End Port	Enter the start/end port number which ranges the External ports used to set the server or Internet applications. Here in this example, enter 21.
To IP address	Enter the IP address of the PC where you want to set the applications. Here in this example, enter 192.168.1.100.
Protocol	Select the protocol (TCP/UDP/Both) for the application.
Enable	Enable the connection
Disable	Disable the connection

 **If your WAN IP address is 192.168.1.100 when accessing your FTP server from external network, your friends only need to enter ftp:// 192.168.1.100:21 in their browsers.**

III-5-3. DMZ

A Demilitarized Zone (DMZ) is an isolated area in your local network where private IP addresses are mapped to specified internet IP addresses, allowing unrestricted access to the private IP addresses but not to the wider local network.

You can define a virtual DMZ host here. This is useful for example, if a network client PC cannot run an application properly from behind an NAT firewall, since it opens the client up to unrestricted two-way access.

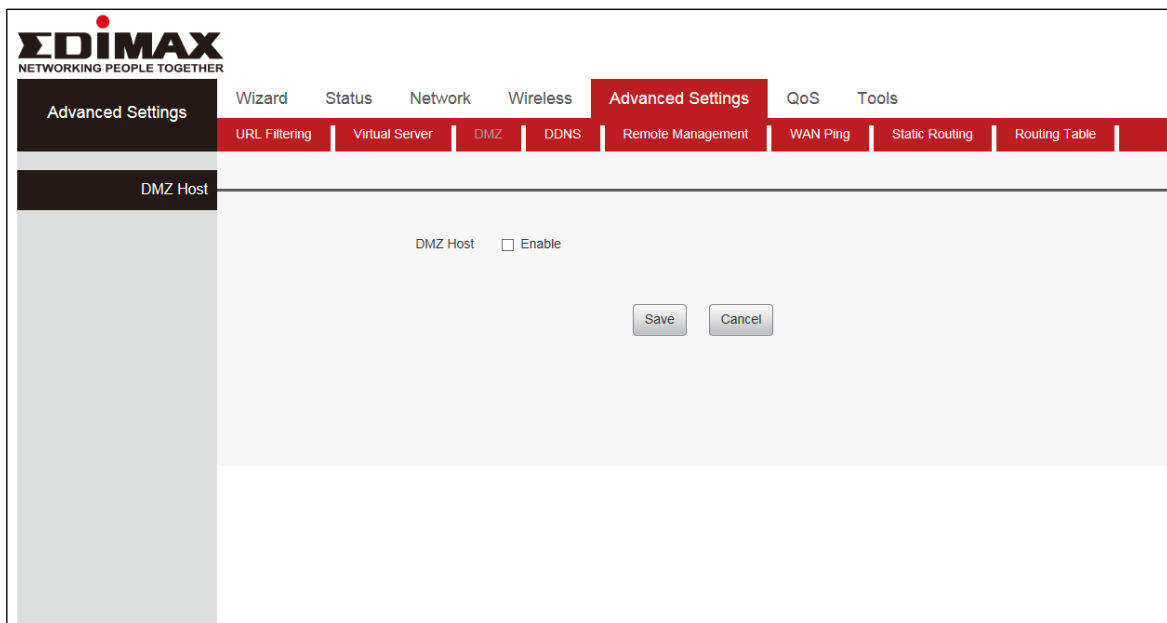

Enable DMZ	Check/uncheck the box to enable/disable the device's DMZ Host function.
-------------------	---

III-5-4. DDNS

Dynamic DNS (DDNS) is a service which provides a hostname-to-IP service for dynamic IP users. The changing nature of dynamic IPs means that it can be difficult to access a service provided by a dynamic IP user; a DDNS service though can map such dynamic IP addresses to a fixed hostname, for easier access. The router supports several DDNS service providers, for more details and to register for a DDNS account please visit the DDNS providers website(s), examples of which are listed below.

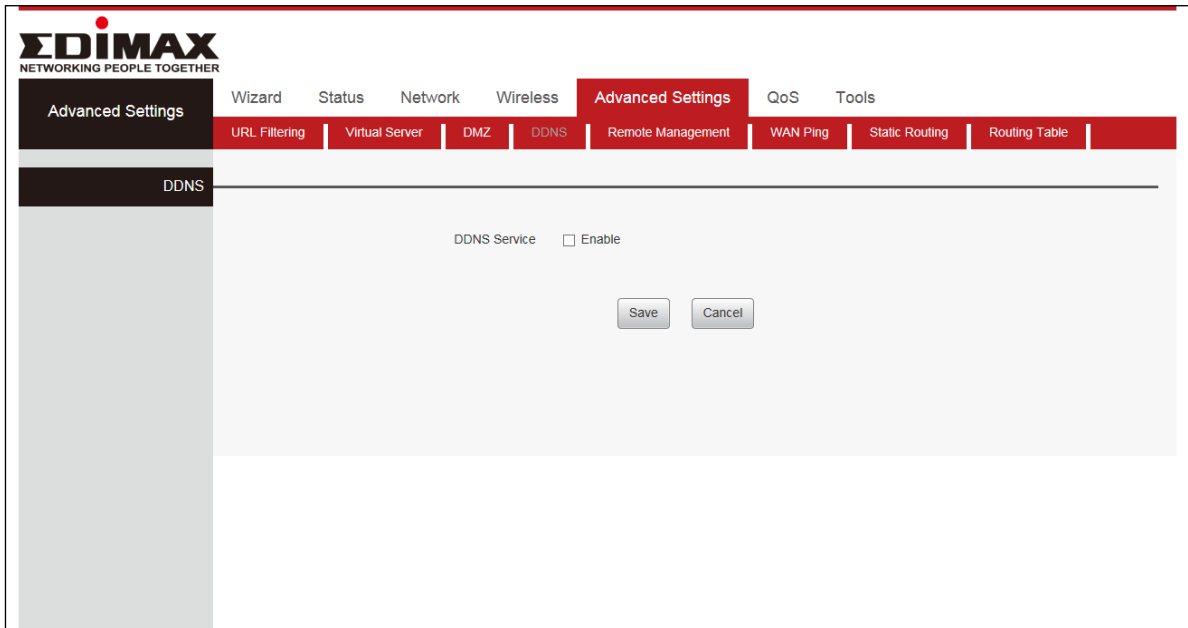

Enable

Check off to enable or disable DDNS Service

Click “Advanced Settings”, Select “DDNS”, Select “Enable”, Add “Serve provider”. Then enter the “User name” and “Password”, enter “Domain Name” and finally Click “Save” to confirm.

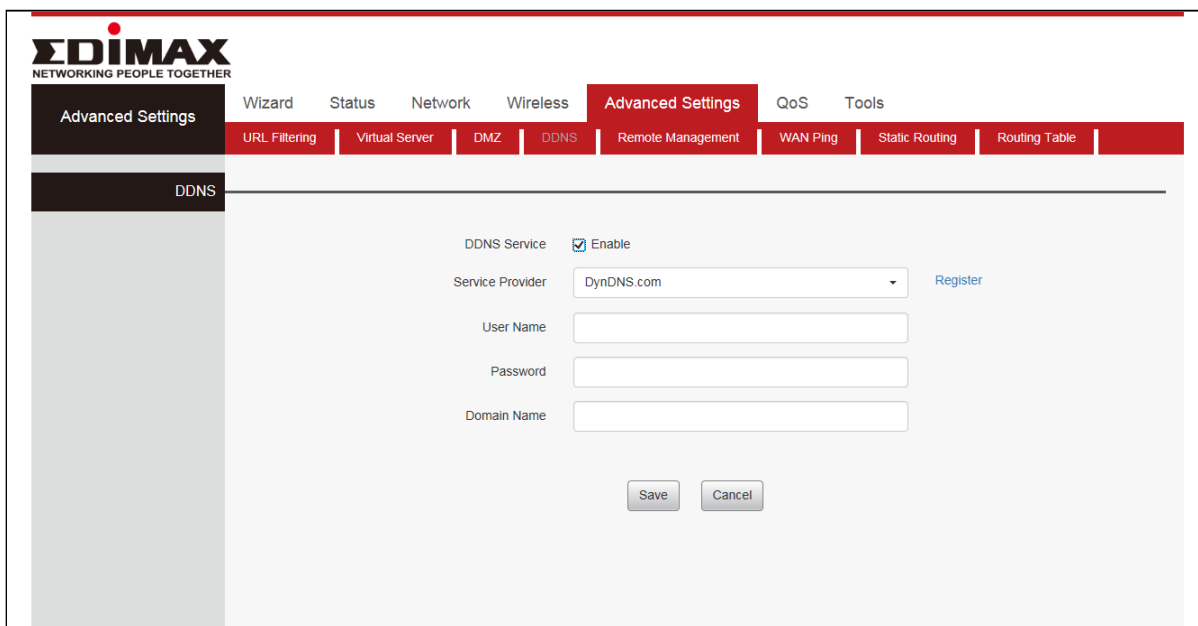

DDNS Service

Click the button to enable or disable the DDNS service.

Service provider	Select one from the drop-down list and click “Sign up” for registration.
Username	Enter the username that you use to register from the DDNS provider.
Password	Enter the password that you use to register from the DDNS provider.
Domain name	Enter the effective registered domain name.

The following DDNS services are supported:

3322 *http://www.3322.org*
DHS *http://www.dhs.org*
DynDNS *http://www.dyndns.org*
88 IP *http://www.88ip.cn/*

III-5-5. Remote Management

This section is to allow the network administrator to manage the router remotely. If you want to access the router remotely, please select “Enable”.

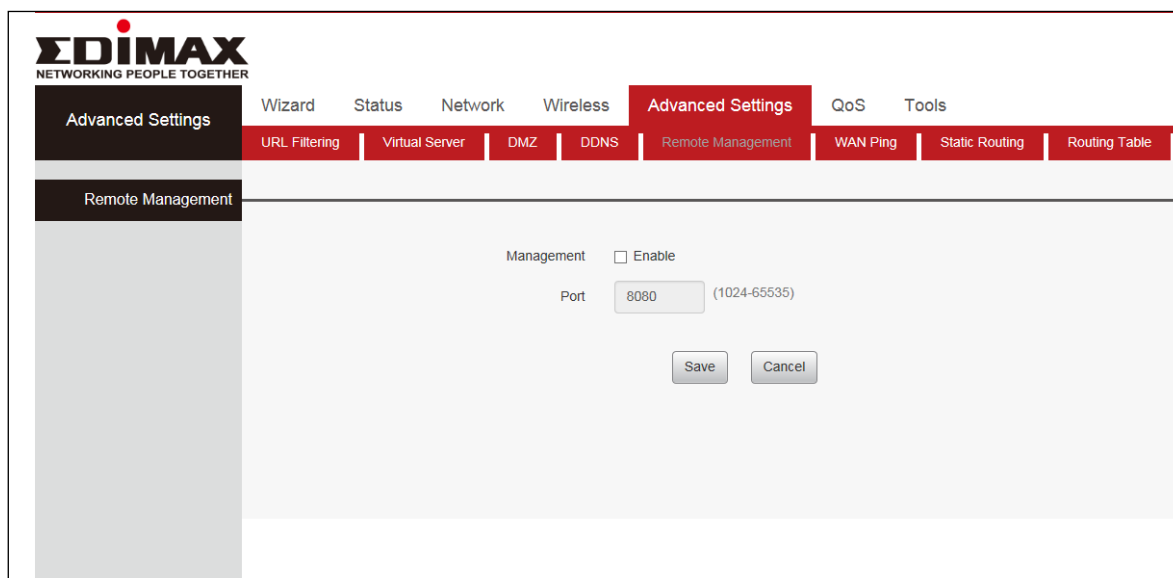

Port	The management port to be open to outside access.
Management	Check “Enable” to enable the remote access feature and then enter the appropriate values.



For better security, configure a port number (between 1024-65535) as remote web management interface, do not use the number of any common service port (1-1024).

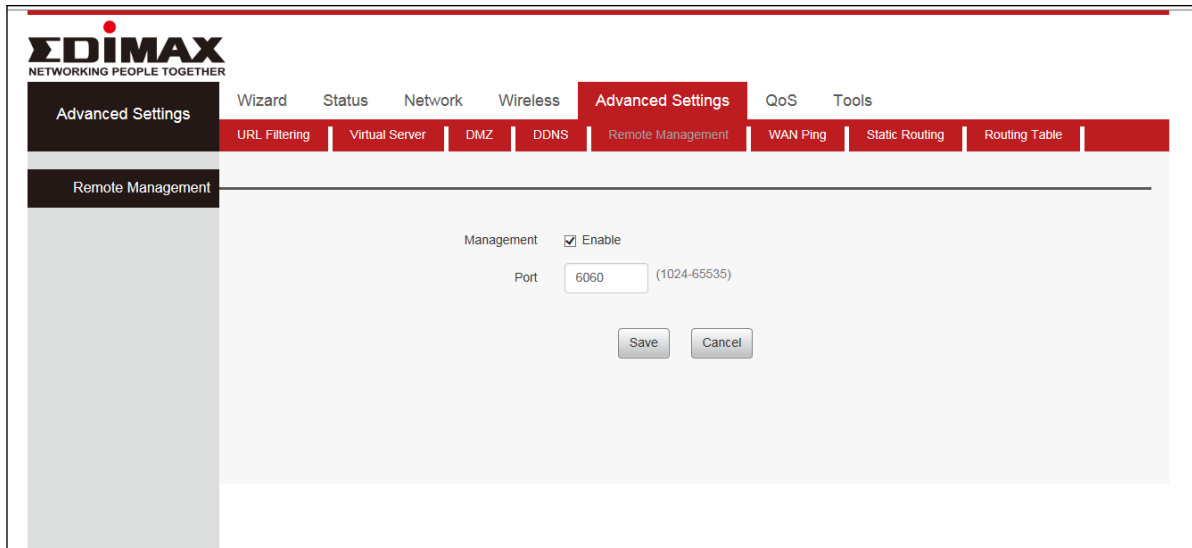

Remote Web Management Application Example:

To access your router (WAN IP address: 172.16.87.160) at your home from the PC (210.16.87.154) at your office via the port number 6060.

Set Steps :

1. Management “Enable”.
2. Enter the Port: 6060.
3. Click “Save” to save your settings.

In the PC 210.16.87.154 Type “[http:// 172.16.87.160:6060](http://172.16.87.160:6060)” into your browser’s address or location field and you can access the router at your home remotely.

III-5-6. WAN Ping

The ping test is to check the status of your internet connection. When disabling the test, the system would prevent the ping test from WAN.

Select the “Advanced Settings”, Select the “WAN Ping” then select the “Enable”.

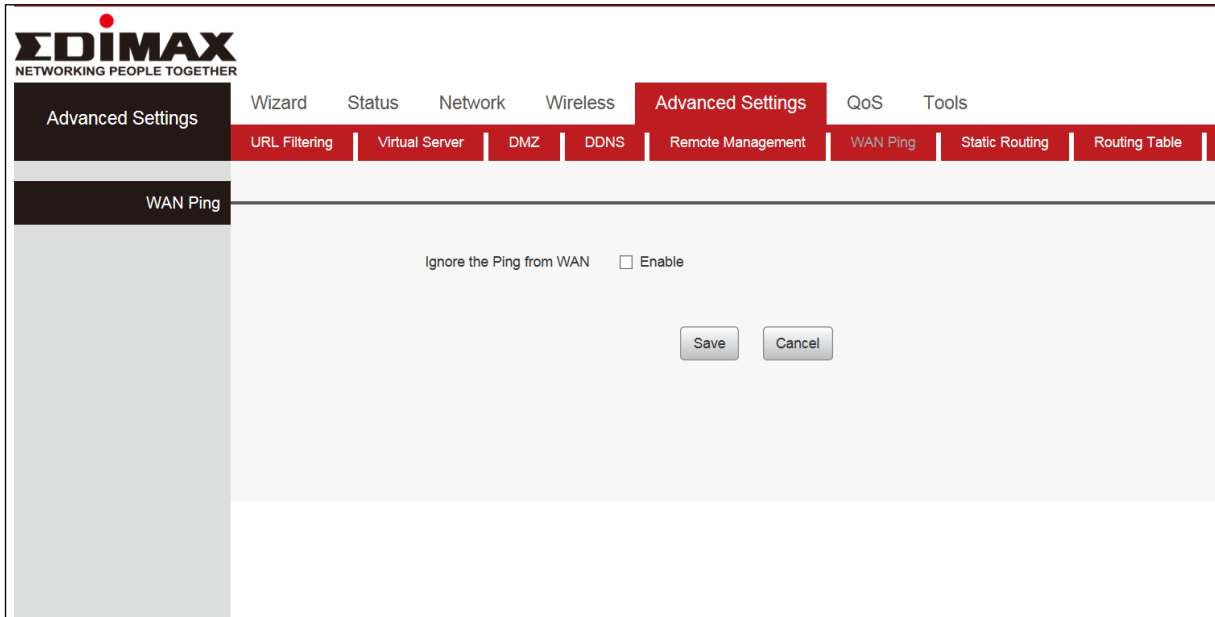

Enable	Check off to enable/disable and the router will not answer ping requests from the Internet.
---------------	---

III-5-7. Static Routing

Static routing is a method of configuring path selection of routers, characterized by the absence of communication between routers regarding the current topology of the network. The opposite of static routing is dynamic routing, sometimes also referred to as adaptive routing.

You can configure static routing and manually add routes to the routing table on this page.

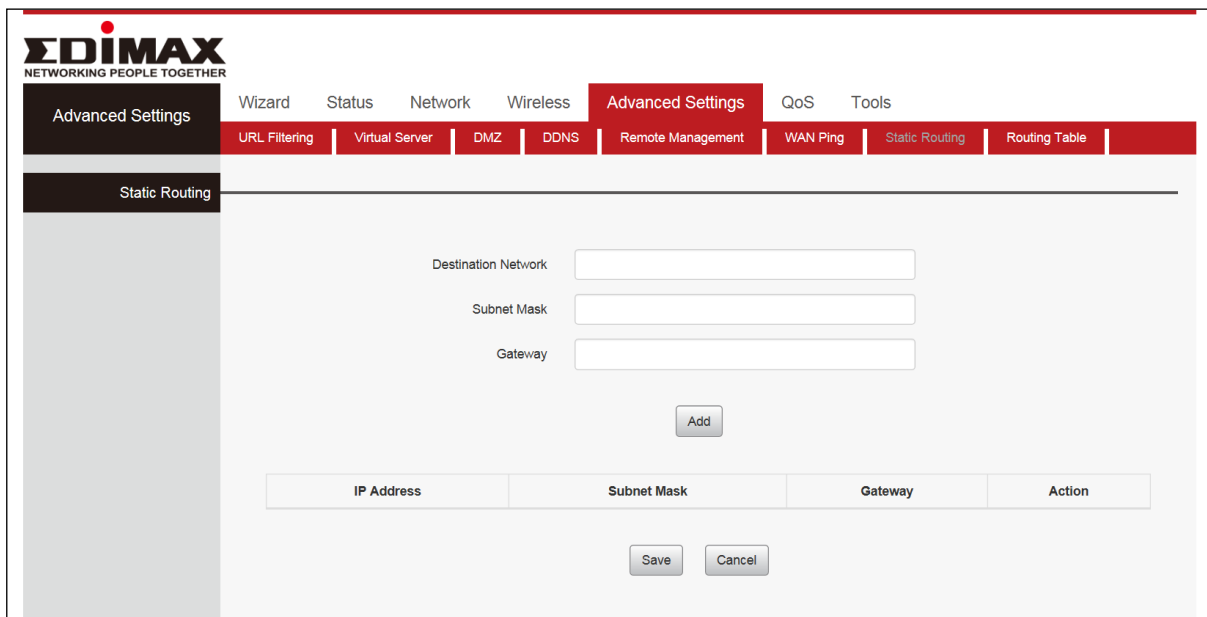

Destination Network	Enter the destination network's IP address.
Subnet Mask	Enter the subnet mask of the destination network.
Gateway	Enter the default gateway of the destination network.
Add	Add the route to the current static routing table.
Action	Specify the action taken by router

III-5-8. Routing Table

In this page you can view the routing table information. Click "Refresh" to update

Destination IP	Subnet Mask	Gateway	Metric	Interface
0.0.0.0	0.0.0.0	192.168.10.1	0	eth1
192.168.1.2	255.255.255.255	192.168.10.1	0	eth1
192.168.1.12	255.255.255.255	192.168.10.1	0	eth1
192.168.2.0	255.255.255.0	192.168.2.0	0	eth0
192.168.10.0	255.255.255.128	192.168.10.0	0	eth1

Destination IP	The IP address of the final destination. "0.0.0.0" indicates any network segment.
Subnet Mask	The subnet mask for the specified destination.
Gateway	This is the next router on the same LAN segment as the router to reach.
Interface	The interface between your router and the final destination.

III-6. QoS

Click “QoS” to enter the configure page. Quality of Service (QoS) is a feature to manage Internet bandwidth efficiently. Some applications require more bandwidth than others to function properly, and QoS allows you to ensure that sufficient bandwidth is available. Minimum or maximum bandwidth can be guaranteed for a specified application. Here you can configure “Bandwidth Control”.

 ***QoS can improve the BR-6428nS V5 performance. QoS is recommended to optimize performance for online gaming.***

III-6-1. Bandwidth Control

Bandwidth control is used to limit communication speed in the LAN. Up to 20 entries can be supported with the capability for at most 254 PCs' speed control.

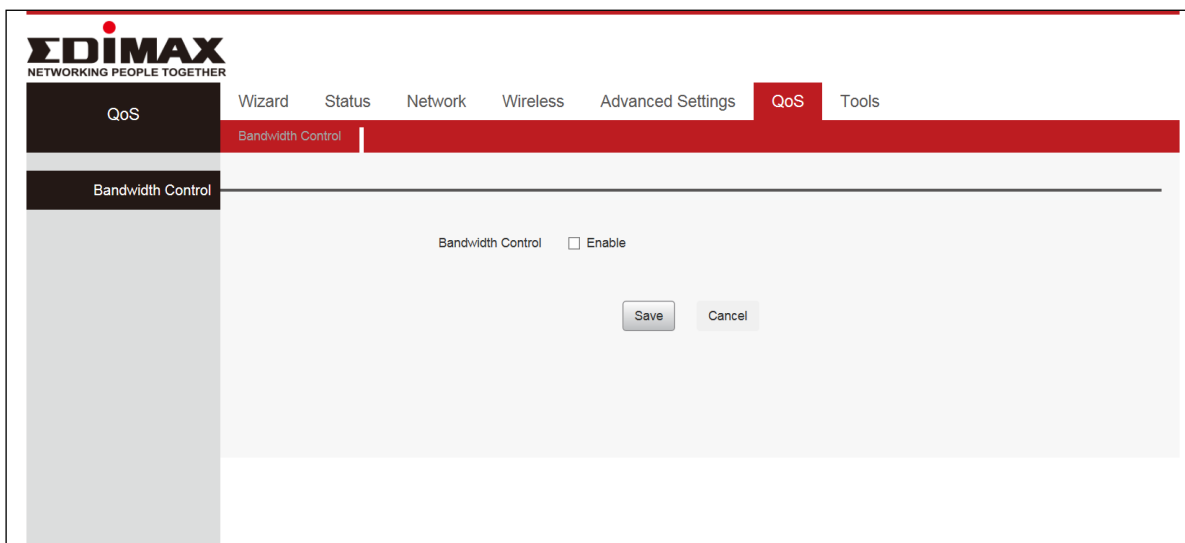

Enable	Check the Enable box to enable the Bandwidth Control feature.
---------------	---

III-7. Tools

Click “Tools” enter the configure page ,here you can set “Time Settings”, “Diagnostic Tool”, “Backup/Restore”, “Factory Default”, “Firmware Upgrade”, “Restart”, “Password”, “System Log”.

III-7-1. Time Settings

This function is to select the time zone for your location. Click “Tools”. Select “Time Settings”. The time will synchronize with the internet automatically in the default situation. Select “Time Zone” then click “Save” to save you settings.

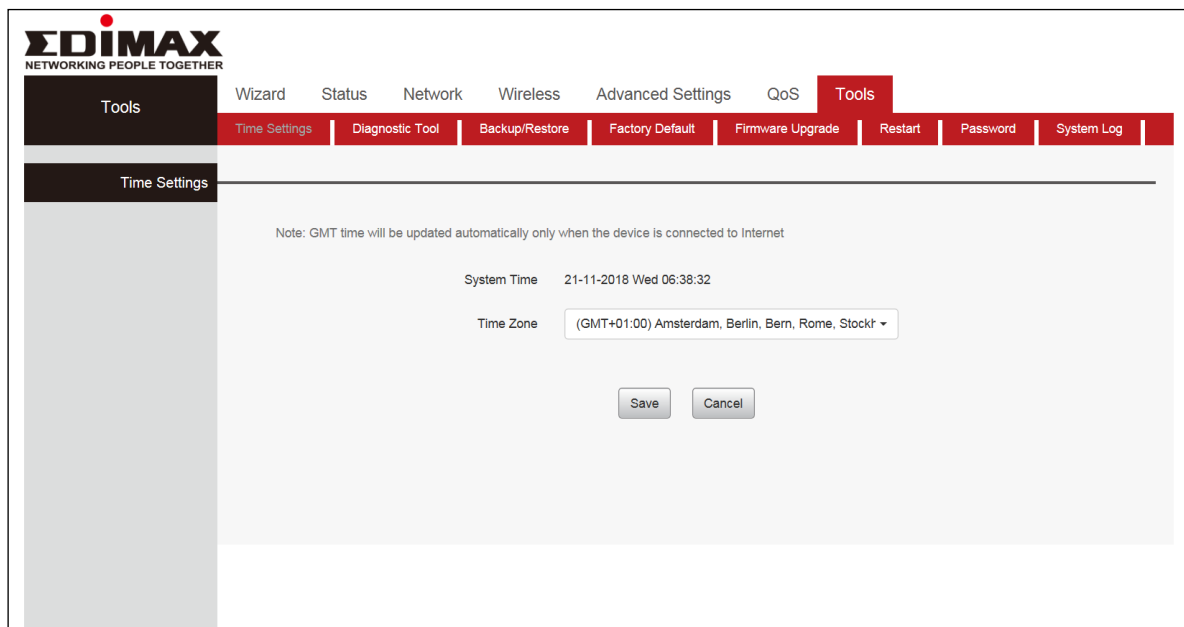

 **Configured time and date info will be lost if the device gets disconnected from power supply. However, it will be updated automatically when the device reconnects to Internet. To activate time-based features (e.g. firewall), the time and date info shall be set correctly first, either manually or automatically.**

III-7-2. Diagnostic Tool

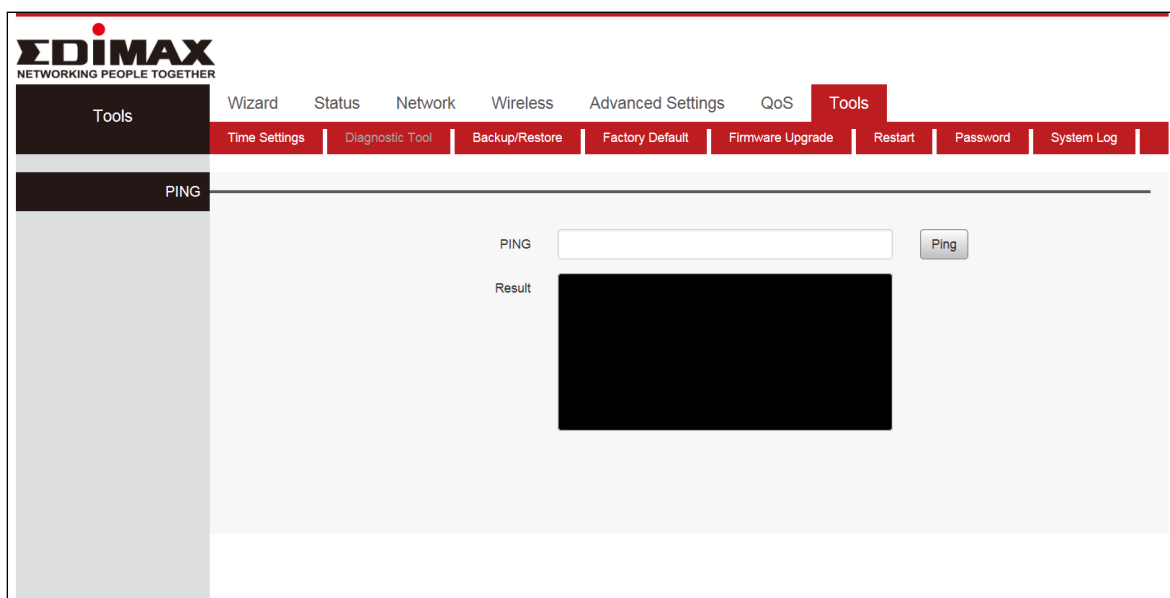

Ping	Troubleshoots connectivity, reachability, and name resolution to a given host or gateway.
-------------	---

III-7-3. Backup/Restore

Click “Tools”, select “Back/Restore”. Choose “Backup” to keep parameters. Click “Browse” to add an file, then click “Save” to save the settings.

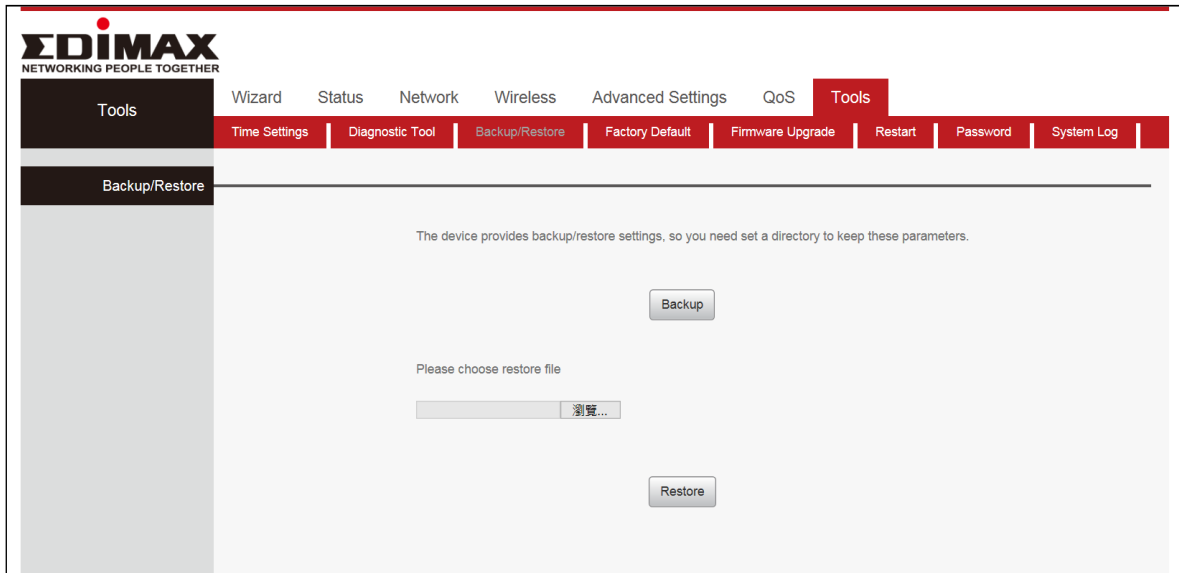

Backup	Click this button to back up the router's configurations.
Restore	Click this button to restore the router's configurations.

 ***The default configuration file name is “RouterCfm.cfg”. Do include the file name suffix of “.cfg” when renaming the file name to avoid problem.***

III-7-4. Factory Default

Click “Tools”, select “Factory Default”.

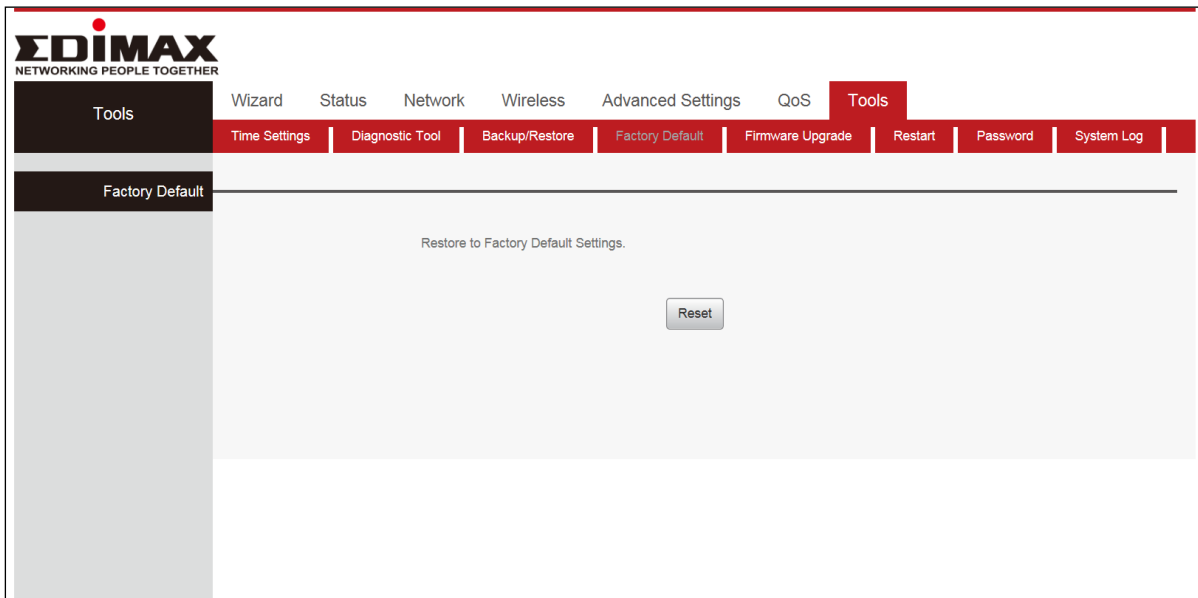

Restore	<p>Reset all configurations to the default values. It means the device will lose all the settings you have set. So please note down the related settings if necessary.</p> <ul style="list-style-type: none">● Default Password: 1234● Subnet Mask:255.255.255.0● Default IP:192.168.2.1
----------------	--

 ***If you enable this option, all current settings will be deleted and be restored to factory default values. You will have to reconfigure Internet connection settings and wireless settings.***

 ***Do not restore factory default settings unless the following happens:***

- ***You need to join a different network or unfortunately forget the login password.***
- ***You cannot access Internet and your ISP or our technical support asks you to reset the router.***

III-7-5. Firmware Upgrade

The upgrade page allows you to upgrade the system firmware to a more recent version. You can download the latest firmware from the Edimax website. After the upgrade, the system will restart.

Click “Tools”, Select “Firmware Upgrade”, click “Browse” and select the upgrade file. Finally, click “Upgrade” and wait for the completion.

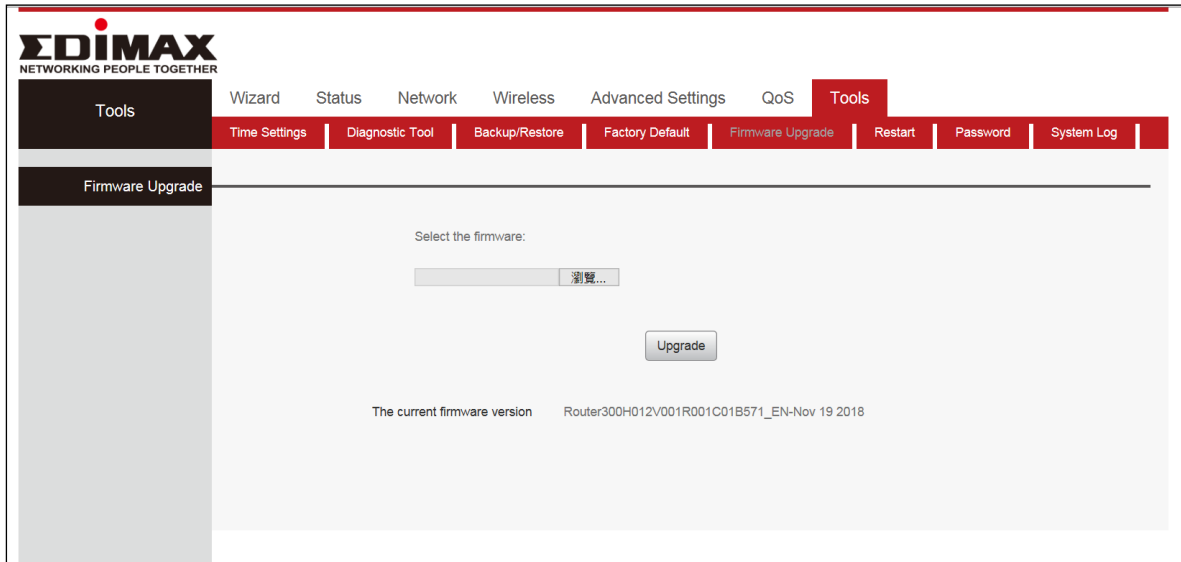

Do not switch off or disconnect the device during a firmware upgrade, as this could damage the device. It is recommended that you use a wired Ethernet connection for a firmware upgrade.

III-7-6. Restart

In the event that the router malfunctions or is not responding, then it is recommended that you restart the device.

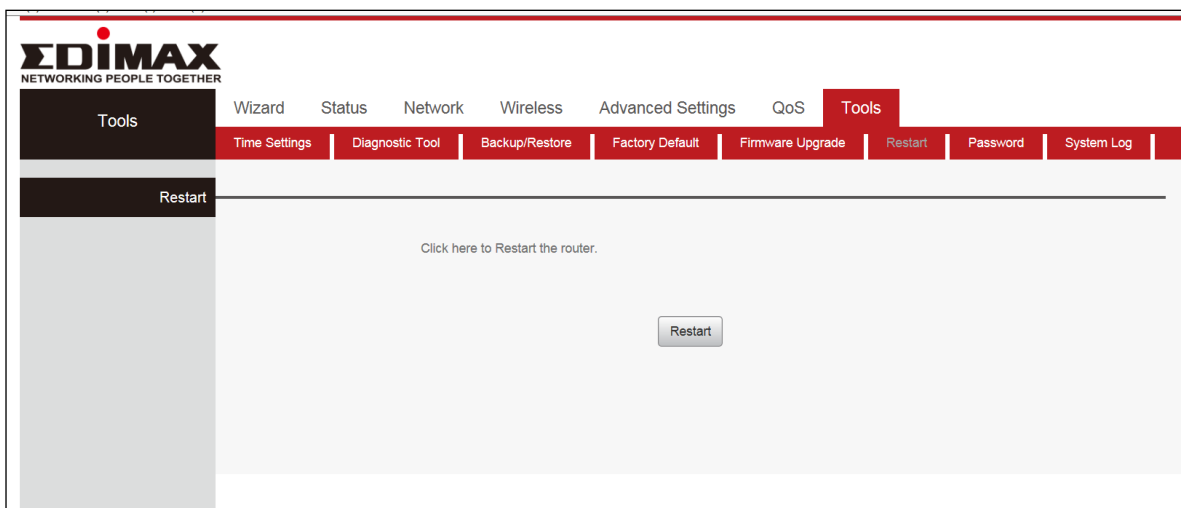

III-7-7. Password

You can change the password used to login to the browser-based configuration interface here. It is advised to do so for security purposes.

 **Please make a note of the new password. In the event that you forget the password and are unable to login to the browser based configuration interface, see [II-5. Reset to factory default settings](#) for how to reset the device.**

Click “Tools”, select “Password”. Enter “Old Password” “New Password” and “Confirm New Password”, then click “Save” to save you settings.

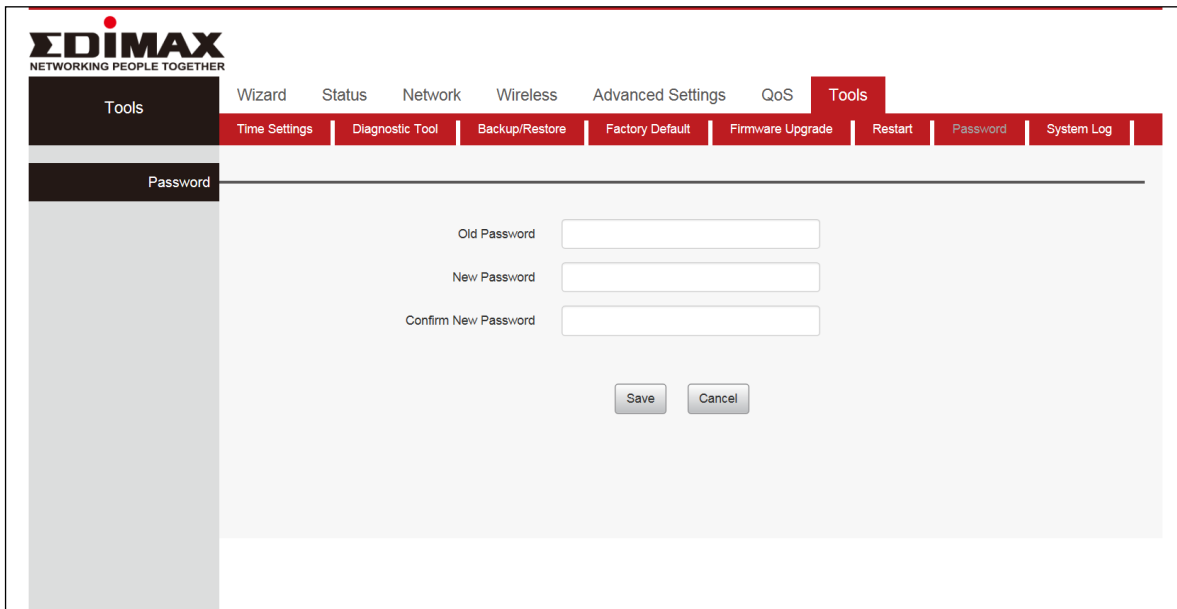

Current Password	Enter your current password.
New Password	Enter your new password.
Confirmed Password	Confirm your new password.

III-7-8. System Log

You can view the system log and security log. Use the page number key in the bottom left corner to select which page to view.

Click “Tools”, Select “System Log”. Click “Refresh” to update the information Or click “Clear” to clear the screen.

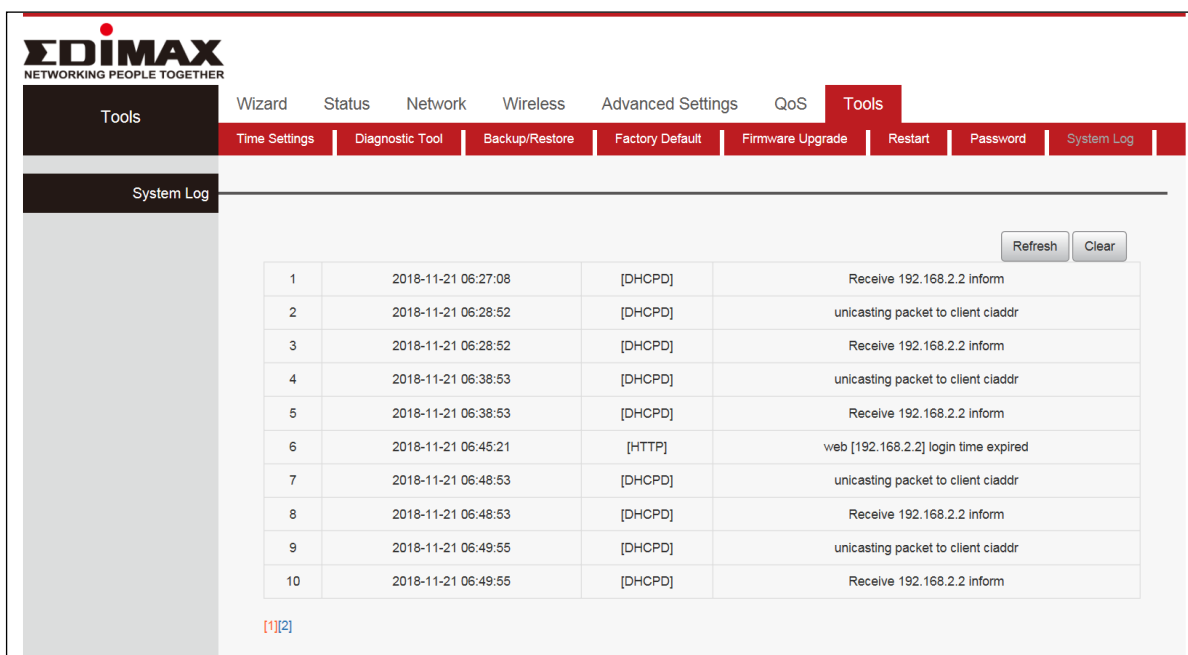

Clear	Click “Clear” to clear/erase the existing log.
Refresh	Click “Refresh” to refresh the log and update any activity.
Page number	Click “[1]” or “[2]” to view different pages of system logs

IV. Appendix

IV-1. Configuring your IP address

For first time access to the URL ***http://192.168.2.1*** please ensure your computer is set to use a dynamic IP address. This means your computer can obtain an IP address automatically from a DHCP server. You can check if your computer is set to use a dynamic IP address by following [IV-1-1. How to check that your computer uses a dynamic IP address.](#)

Static IP users can also temporarily modify your computer's IP address to be in the same IP address subnet e.g. **192.168.2.x (x = 3 – 254)** as the BR-6428nS V5 in order to access ***http://192.168.2.1***.



The BR-6428nS V5 default IP address is 192.168.2.1.

The procedure for modifying your IP address varies across different operating systems; please follow the guide appropriate for your operating system in [IV-1-2. How to modify the IP address of your computer.](#)



Static IP users please make a note of your static IP before you change it.

You can assign a new IP address to the device which is within the subnet of your network during setup or using the browser based configuration interface (refer to [III-3-4. LAN](#)). Then you can access the URL ***http://192.168.2.1*** in future without modifying your IP address.



Please remember to change your IP address back to its original value after the device is properly configured.

IV-1-1. How to check that your computer uses a dynamic IP address

Please follow the instructions appropriate for your operating system.

IV-1-1-1. Windows 7

1. Click the “Start” button (it should be located in the lower-left corner of your computer), then click “Control Panel”.

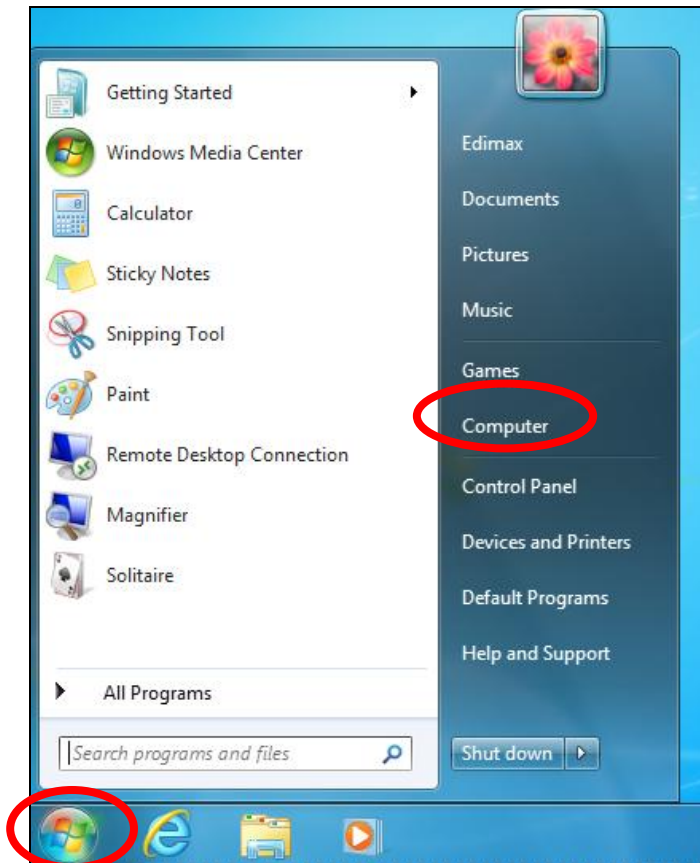

2. Click “Network and Internet”.

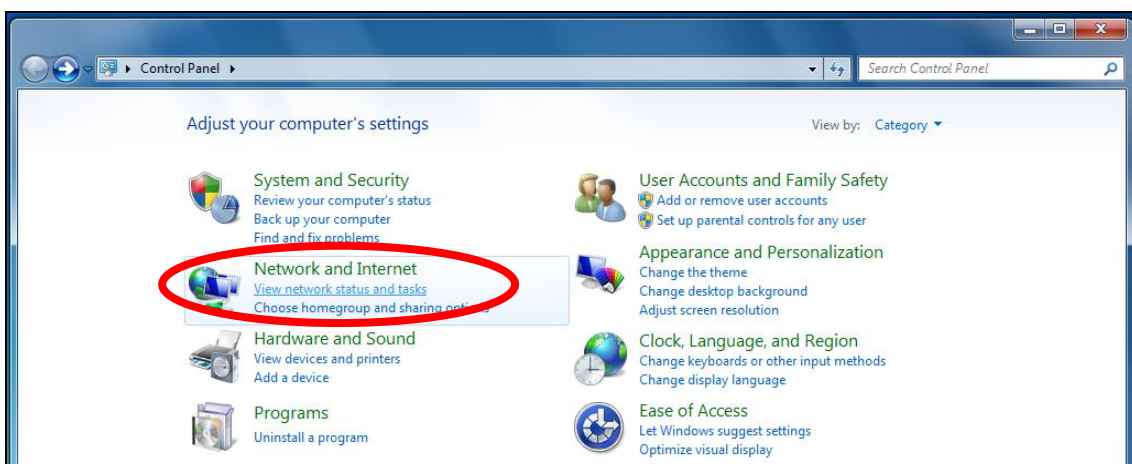

3. Then click “Network and Sharing Center”.

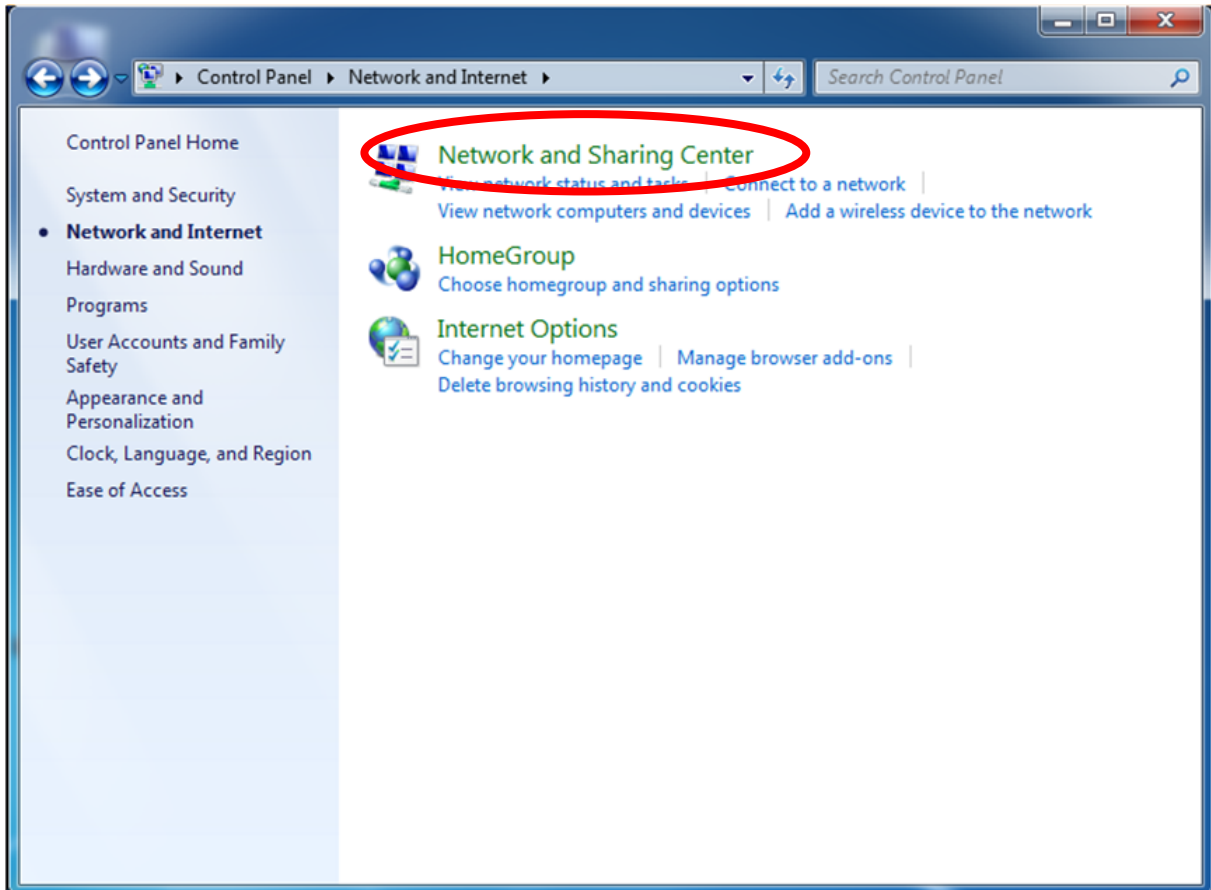

4. Click “Change adapter settings”.

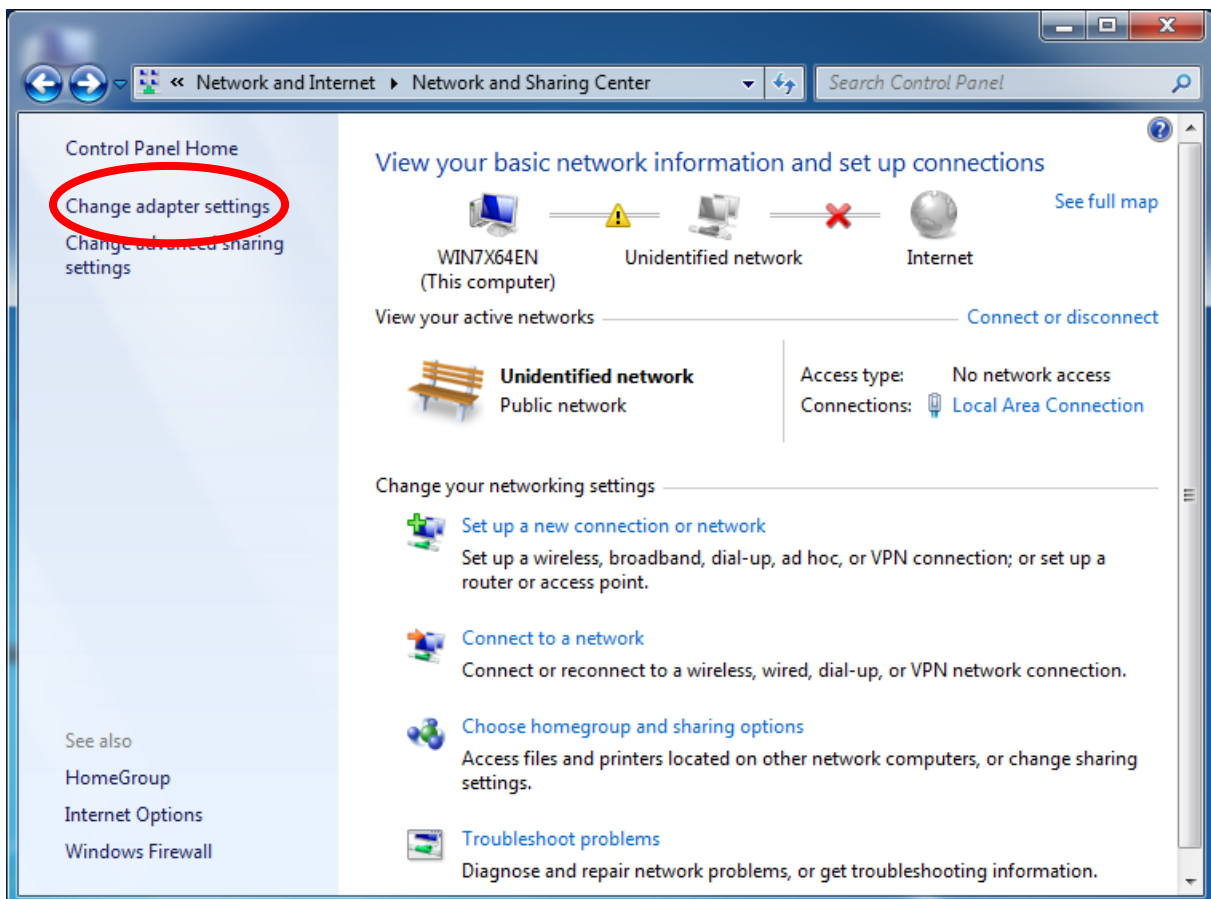

5. Click “Local Area Connection” and select “Properties”.

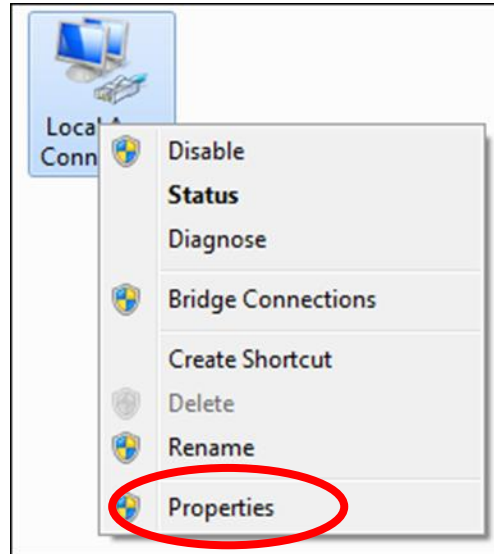

6. Select “Internet Protocol Version 4 (TCP/IPv4)” and then click “Properties”.

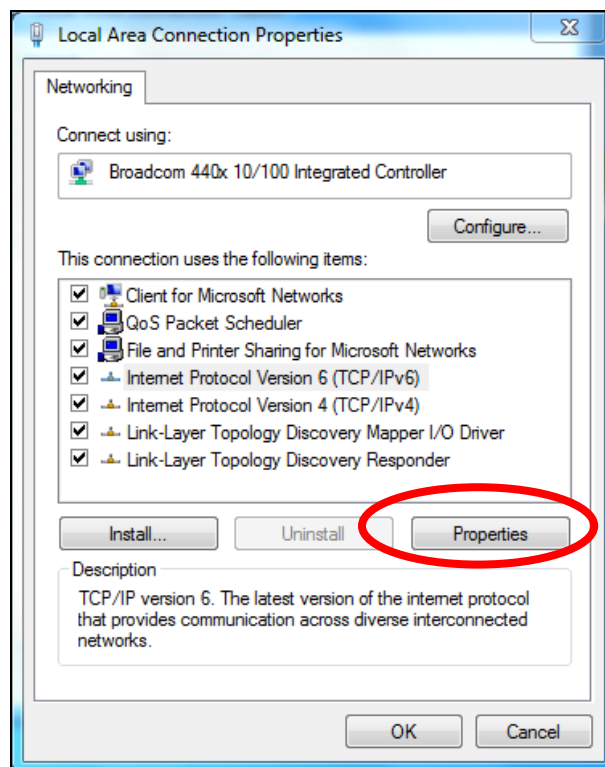

7. “Obtain an IP address automatically” and “Obtain DNS server address automatically” should be selected.

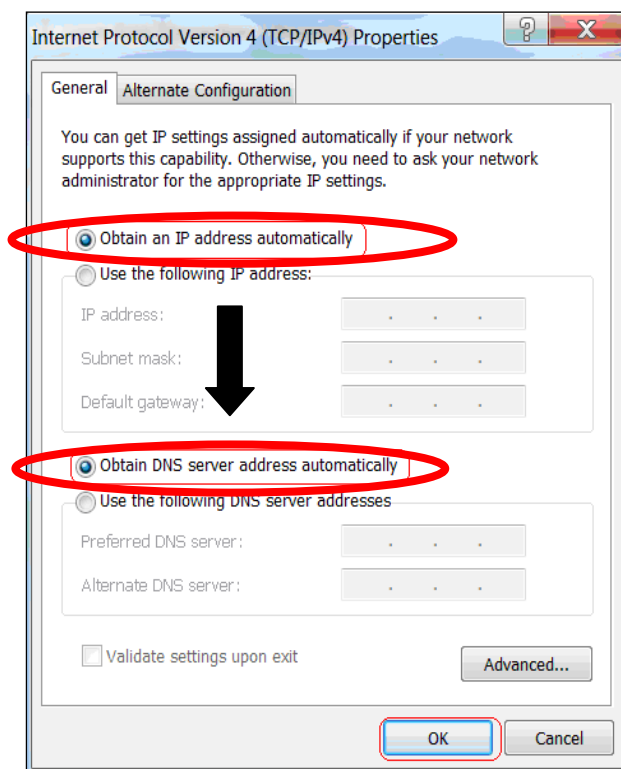

8. Click “OK” on the “Local Area Connection Properties” window to save your settings.

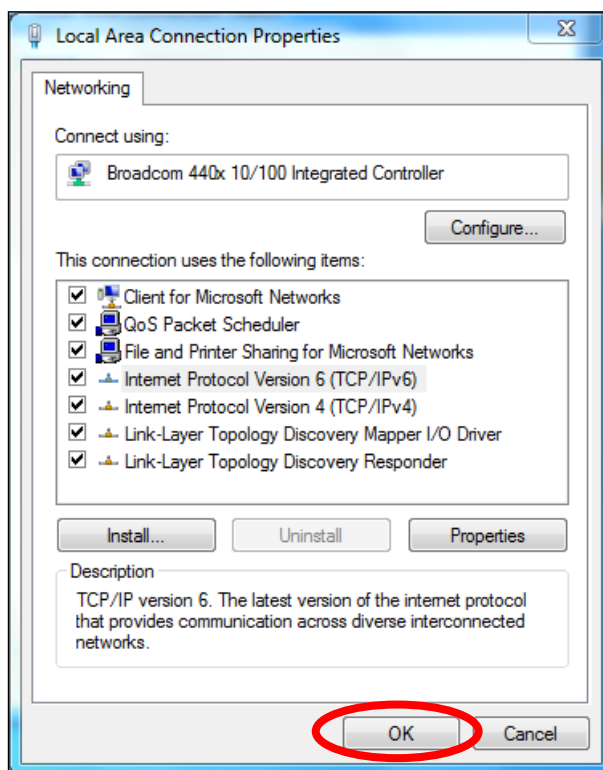

IV-1-1-2. Windows 8

1. From the Windows 8 Start screen, you need to switch to desktop mode. Move your cursor to the bottom left of the screen and click.

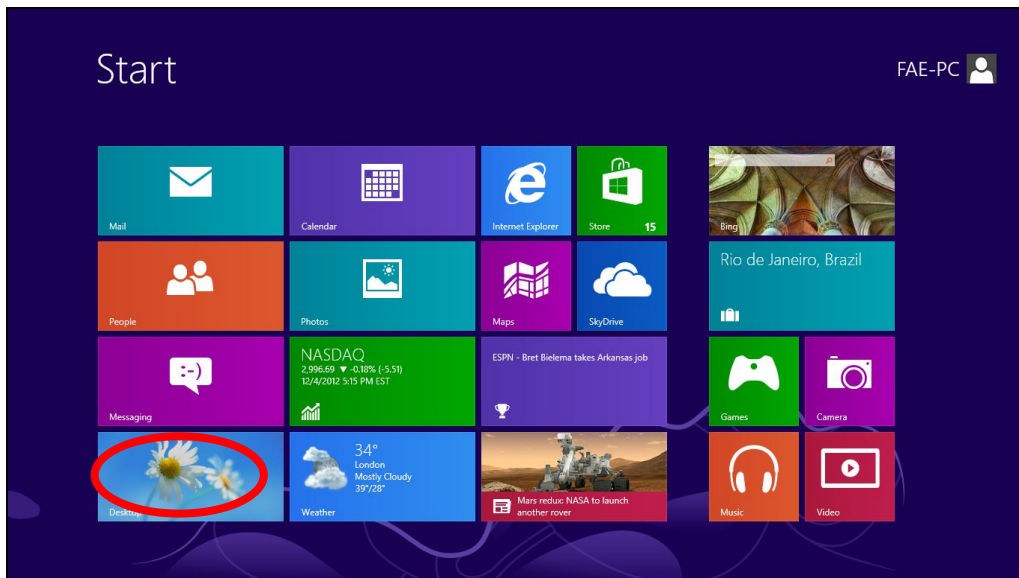

2. In desktop mode, click the File Explorer icon in the bottom left of the screen, as shown below.

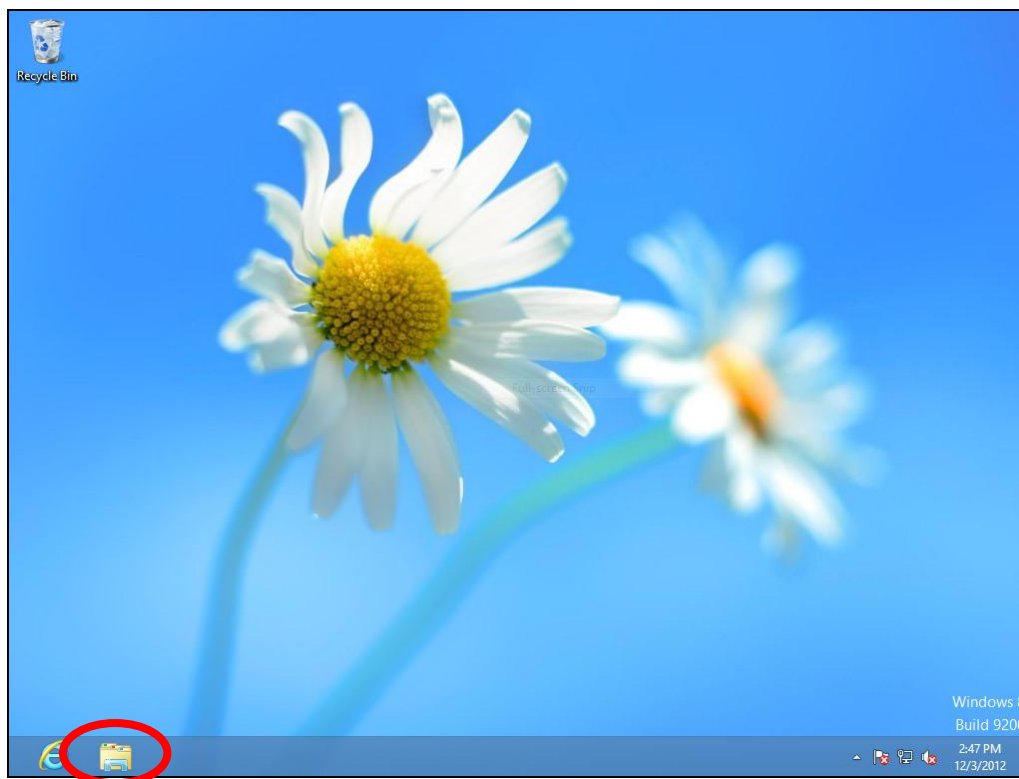

3. Right click “Network” and then select “Properties”.

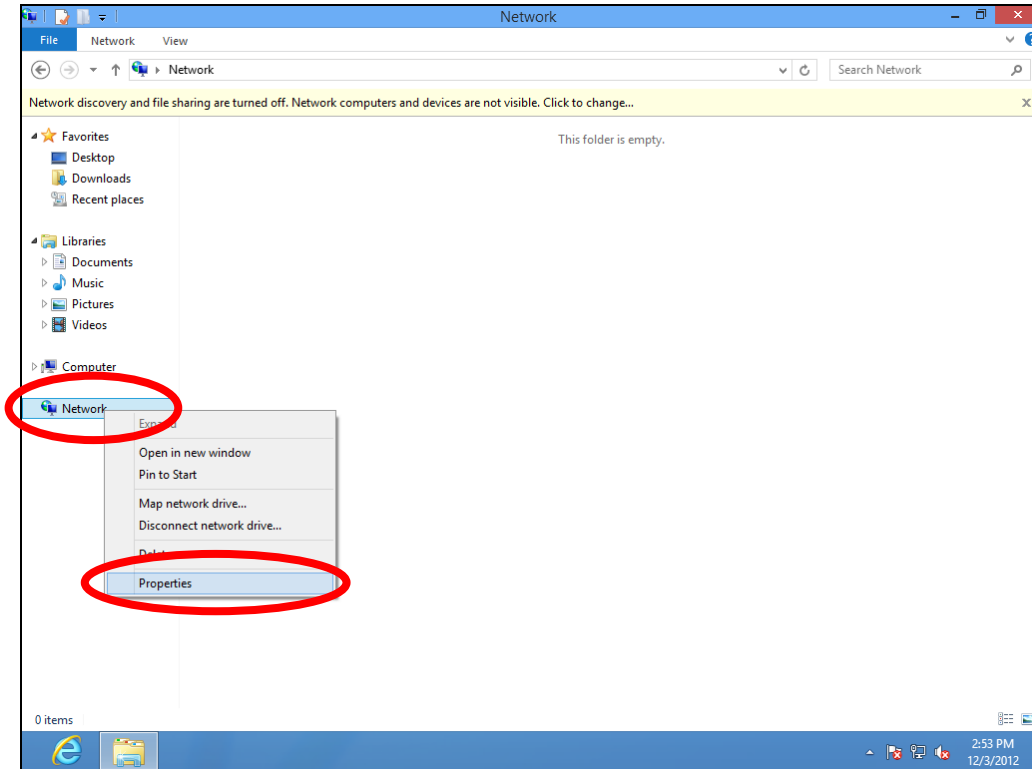

4. In the window that opens, select “Change adapter settings” from the left side.

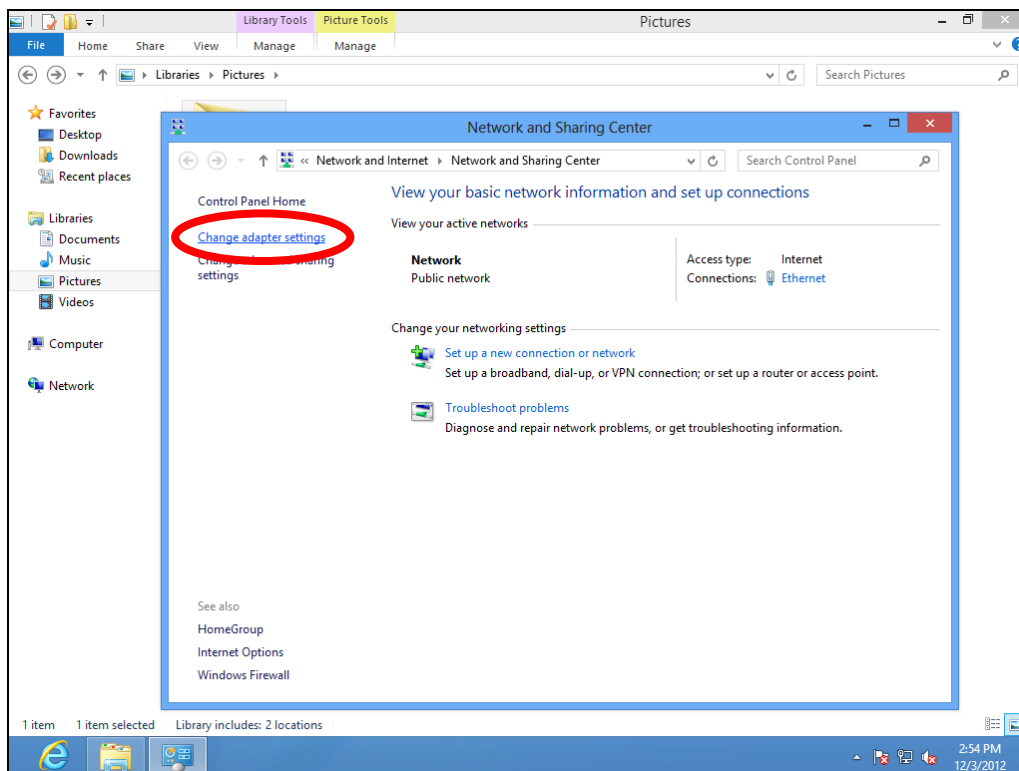

5. Choose your connection and right click, then select “Properties”.

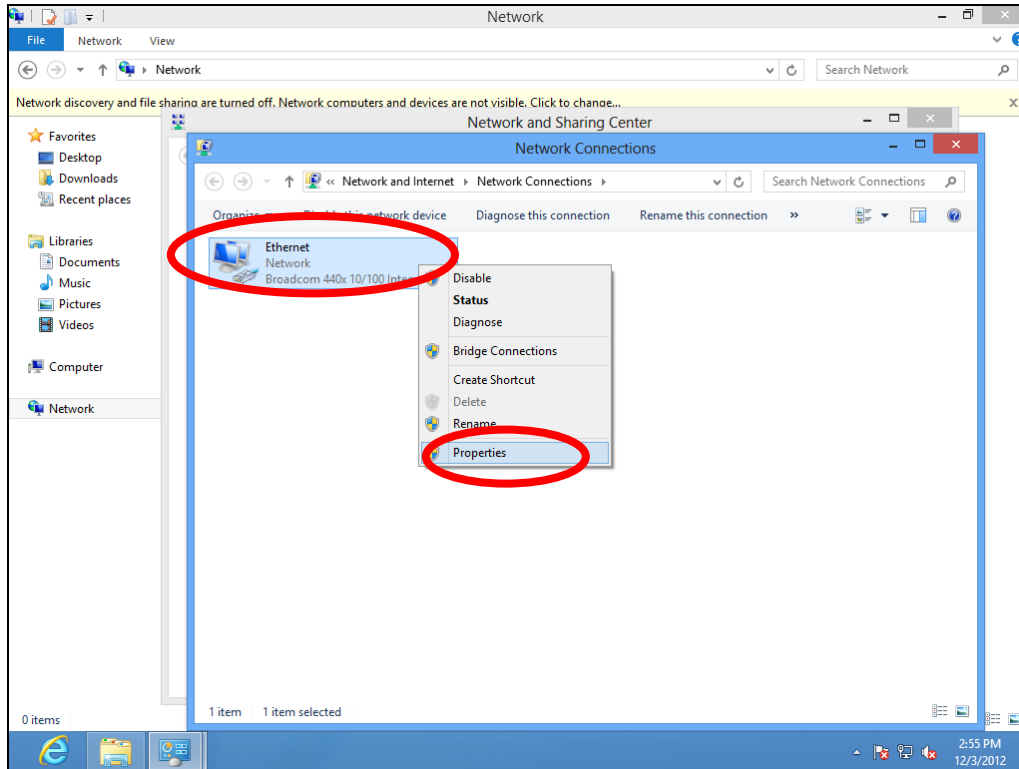

6. Select “Internet Protocol Version 4 (TCP/IPv4)” and then click “Properties”.

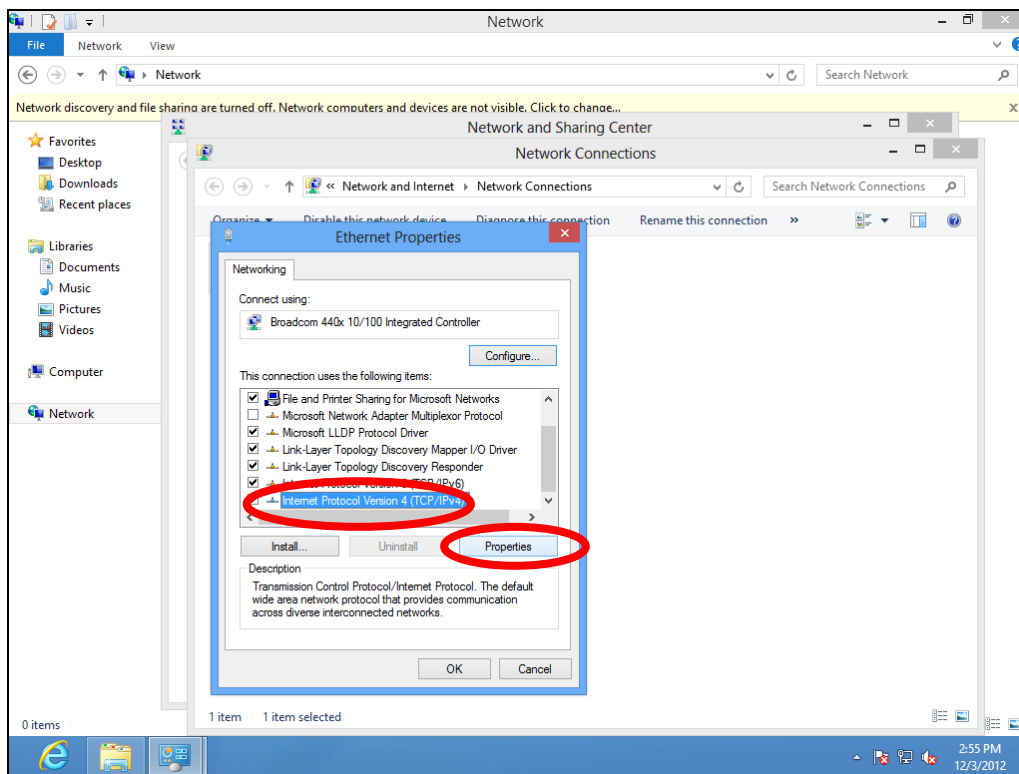

7. Select “Obtain an IP address automatically” and “Obtain DNS server address automatically” should be selected.

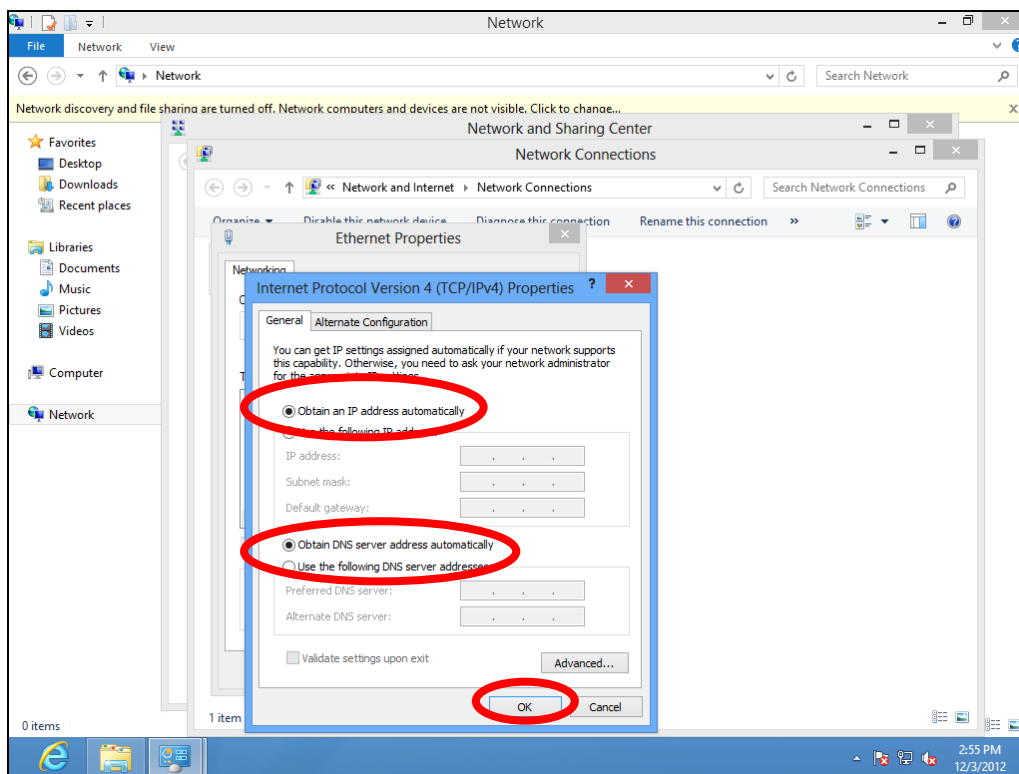

IV-1-1-3. Windows 10

1. From the Windows 10 Start screen, click on “Start” and select “Settings”.

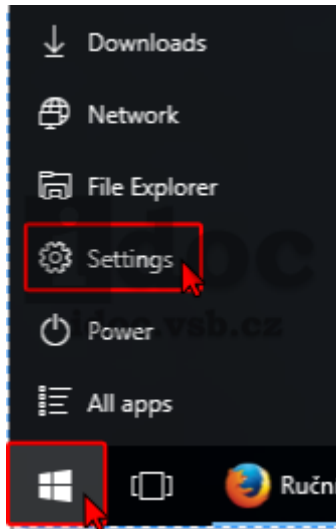

2. Choose “Network & Internet”, then select “Network sharing center, Click “Change adapter settings”. Choose “Ethernet”, click right mouse button and choose “Properties”.

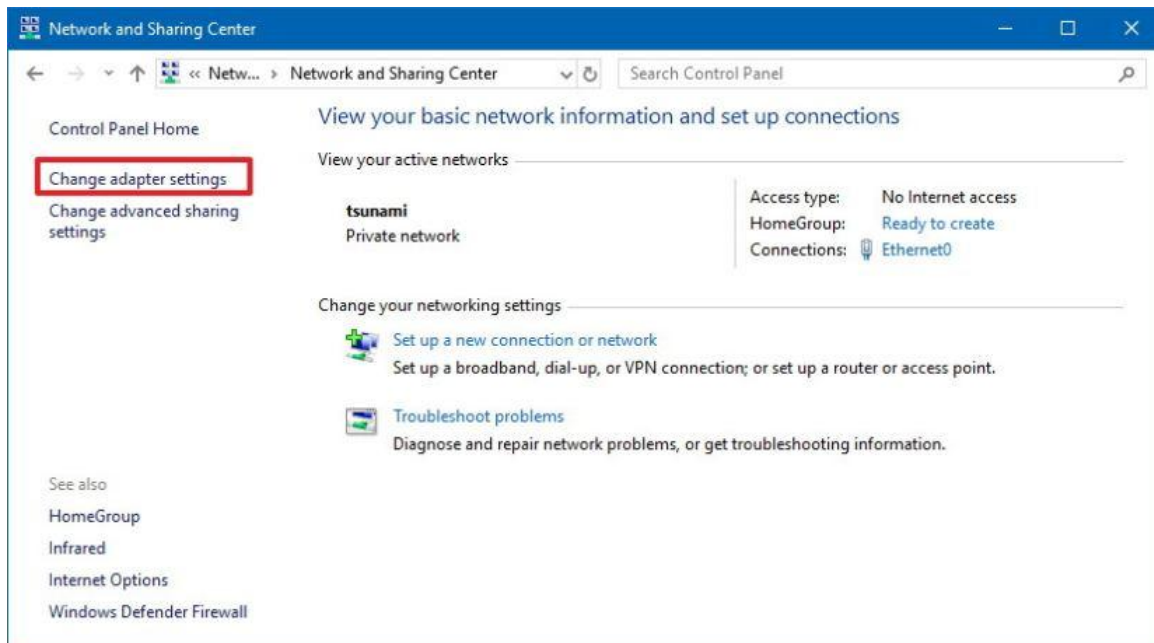

3. Right click the desired network connection and select “Properties”. Then Select the Internet Protocol Version 4 (TCP/IPv4) option. Click up “Properties”.

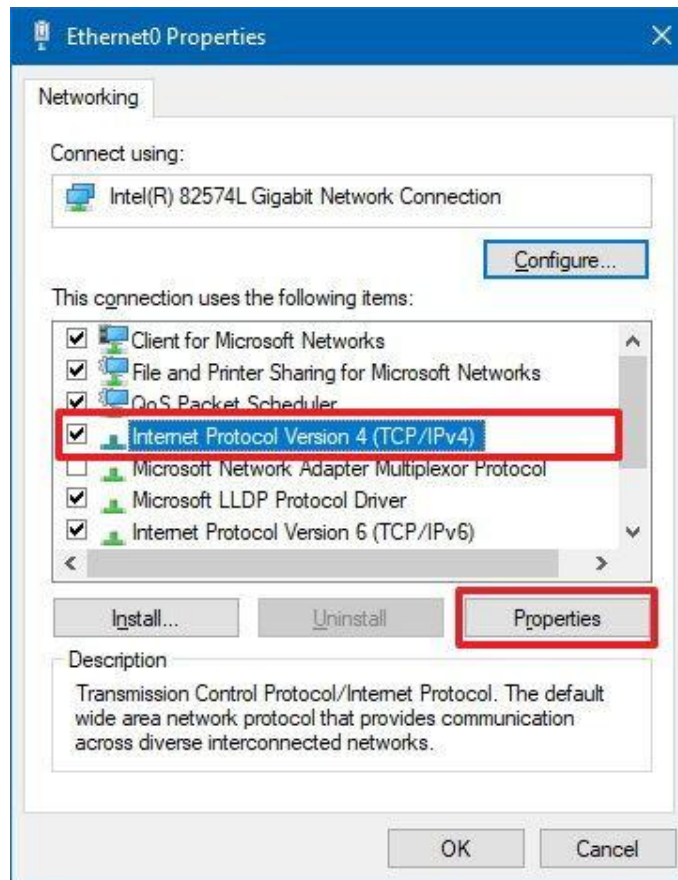

4. Select “Obtain an IP address automatically” and “Obtain DNS server address automatically” should be selected.

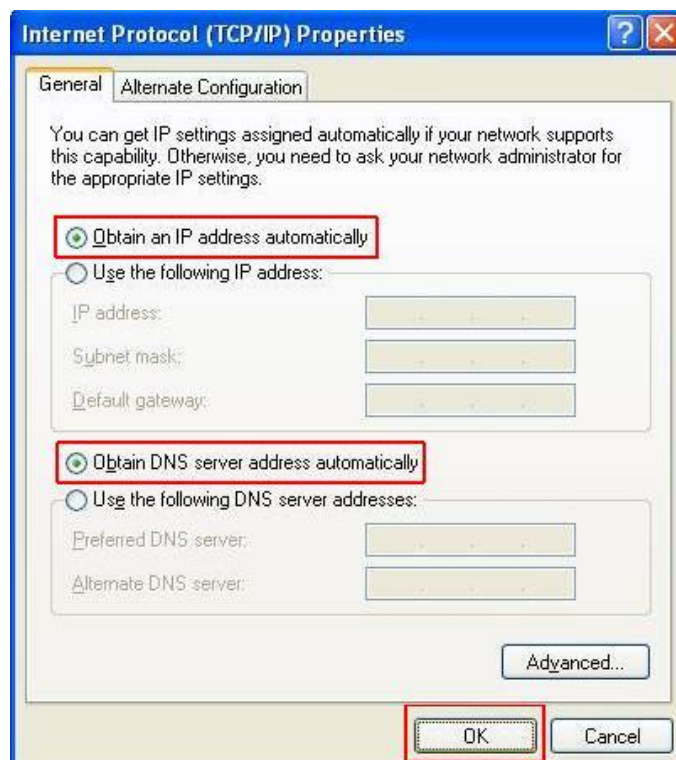

IV-1-1-4. Mac OS

1. Have your Macintosh computer operate as usual, and click on “System Preferences”.

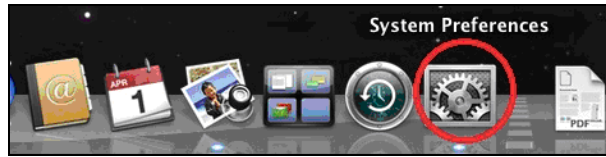

2. In System Preferences, click on “Network”.



3. Click on “Wi-Fi” in the left panel and then click “Advanced” in the lower right corner.

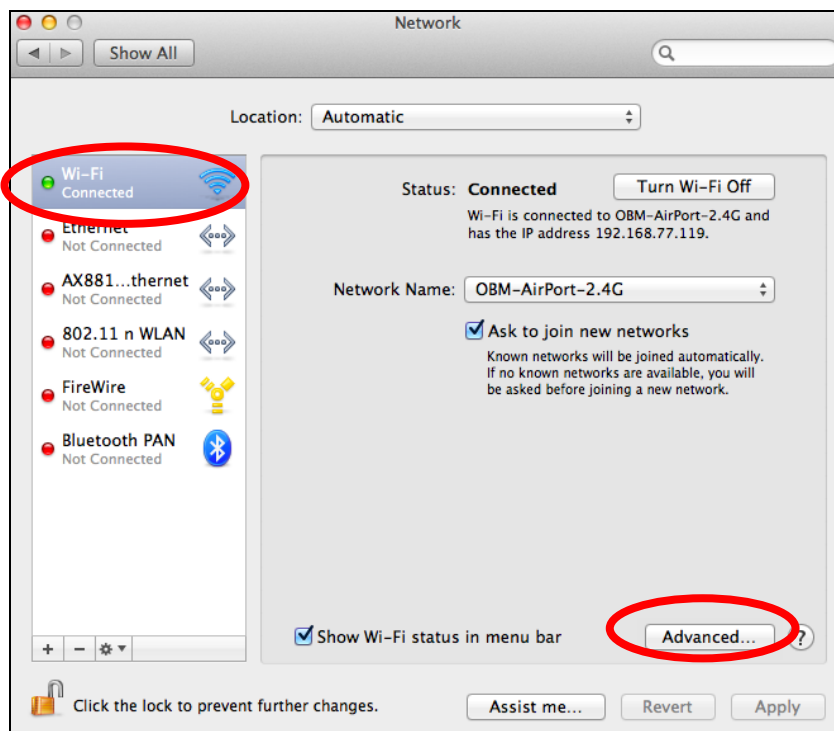

4. Select “TCP/IP” from the top menu and “Using DHCP” in the drop down menu labeled “Configure IPv4” should be selected.

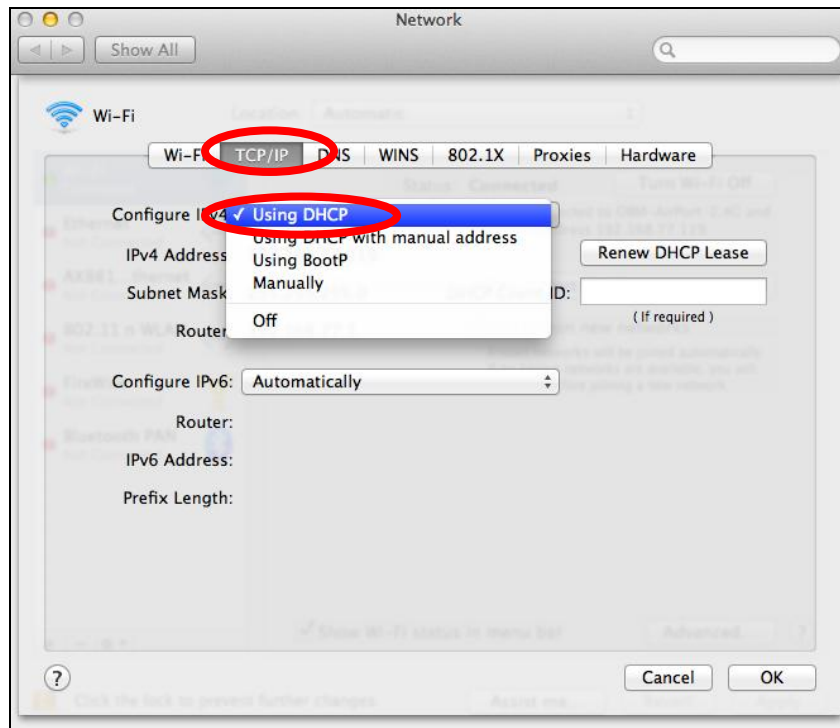

IV-1-2. How to modify the IP address of your computer

Please follow the instructions appropriate for your operating system. In the following examples we use the IP address **192.168.2.10** though you can use any IP address in the range **192.168.2.x (x = 3 – 254)** in order to access iQ Setup/browser based configuration interface.

 ***Please make a note of your static IP before you change it.***

IV-1-2-1. Windows 7

1. Click the “Start” button (it should be located in the lower-left corner of your computer), then click “Control Panel”.

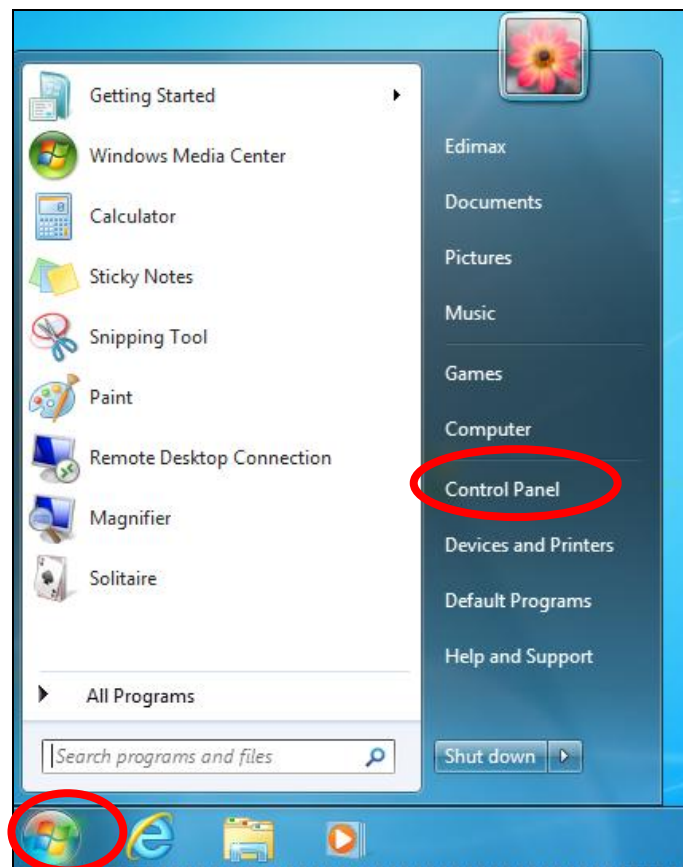

2. Under “Network and Internet” click “View network status and tasks”.

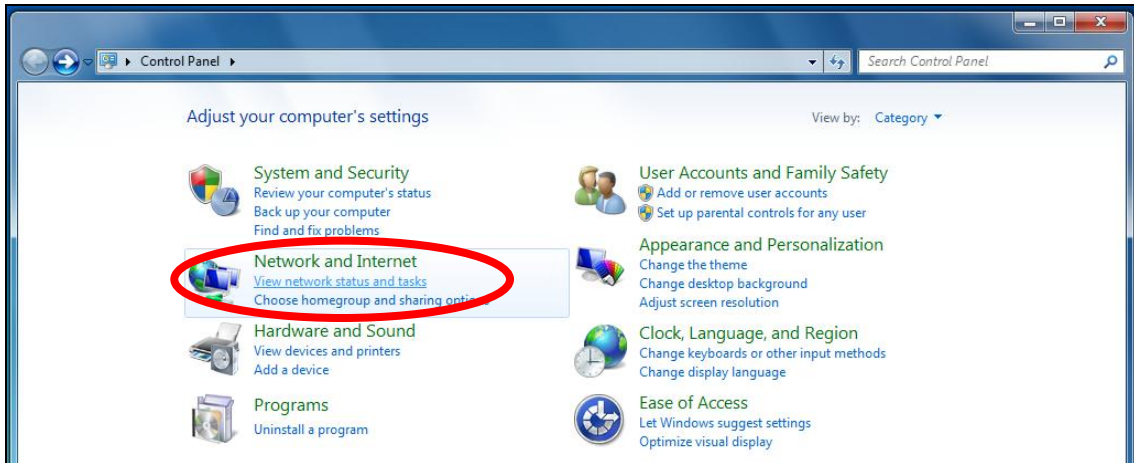

3. Click “Local Area Connection”.

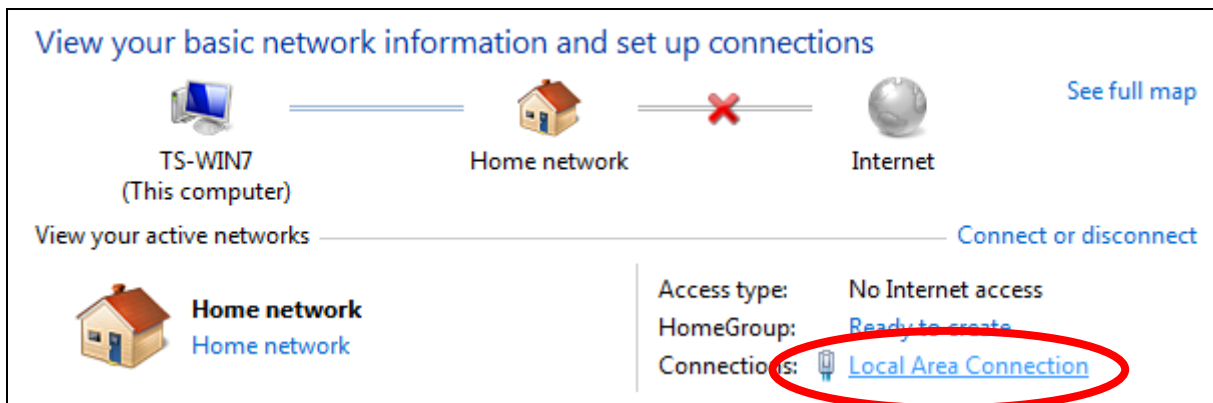

4. Click “Properties”.

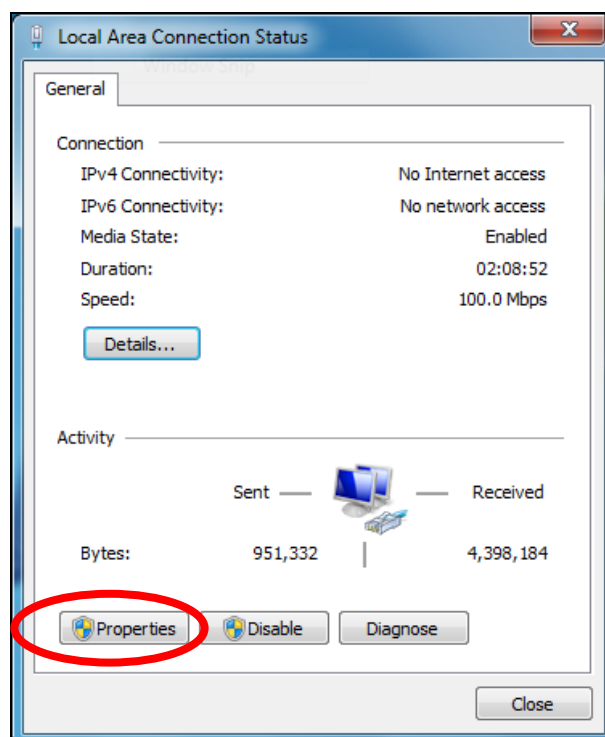

5. Select “Internet Protocol Version 4 (TCP/IPv4) and then click “Properties”.

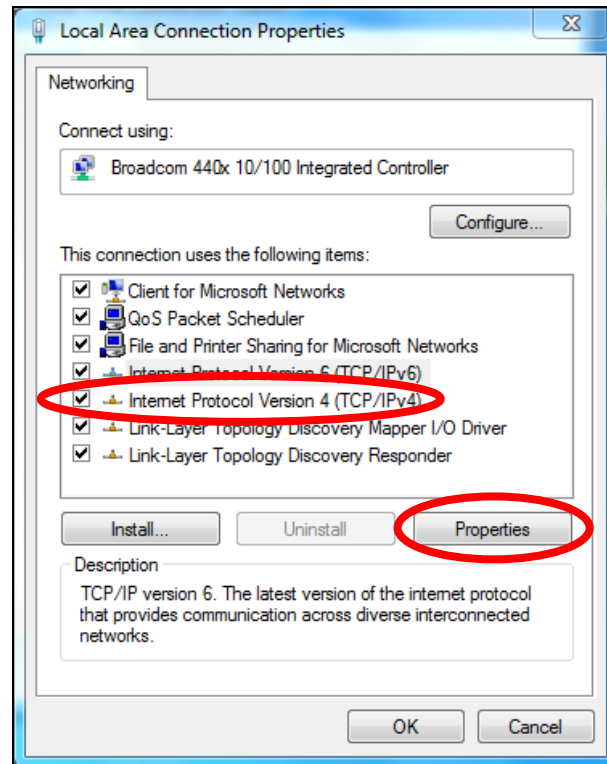

6. Select “Use the following IP address” and “Use the following DNS server addresses”, then input the following values:



Your existing static IP address will be displayed in the “IP address” field before you replace it. Please make a note of this IP address, subnet mask, default gateway and DNS server addresses.

IP address: 192.168.2.10

Subnet Mask: 255.255.255.0

Preferred DNS Server: 192.168.2.1

Click ‘OK’ when finished.

IV-1-2-2. Windows 8

1. From the Windows 8 Start screen, you need to switch to desktop mode. Move your cursor to the bottom left of the screen and click.

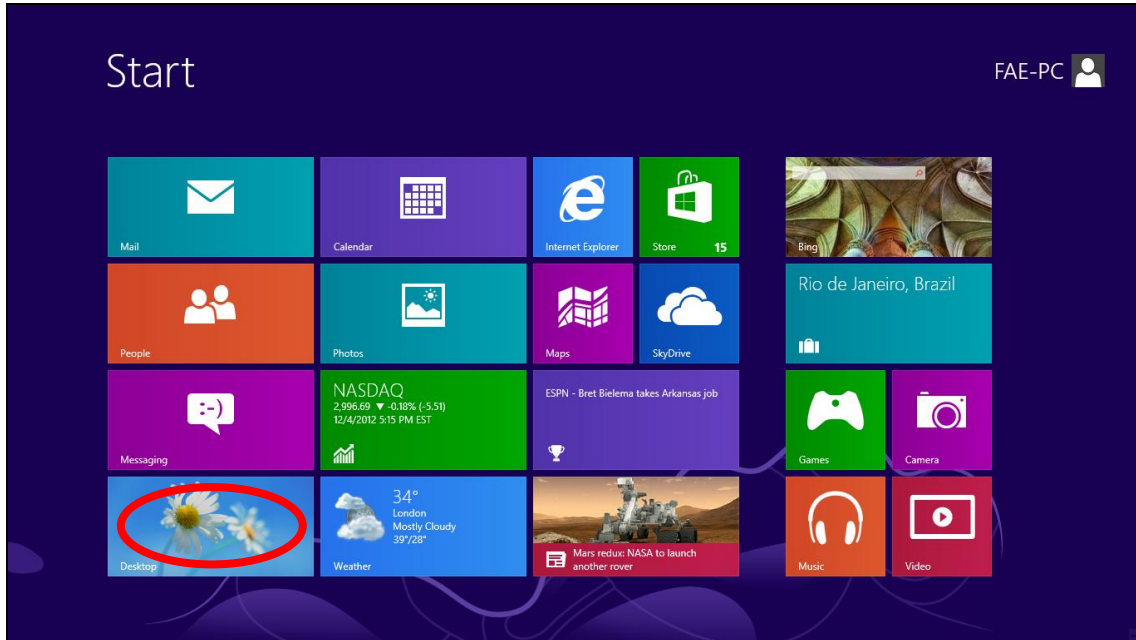

2. In desktop mode, click the File Explorer icon in the bottom left of the screen, as shown below.

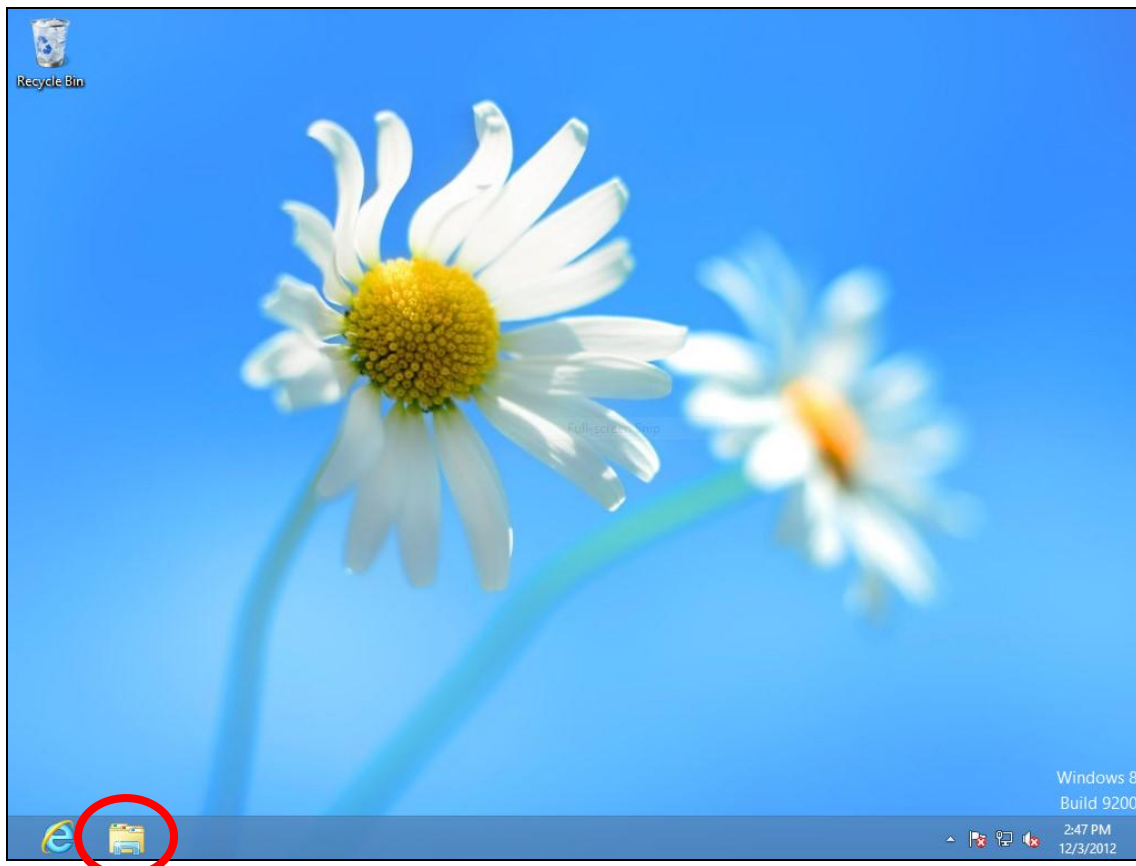

3. Right click “Network” and then select “Properties”.

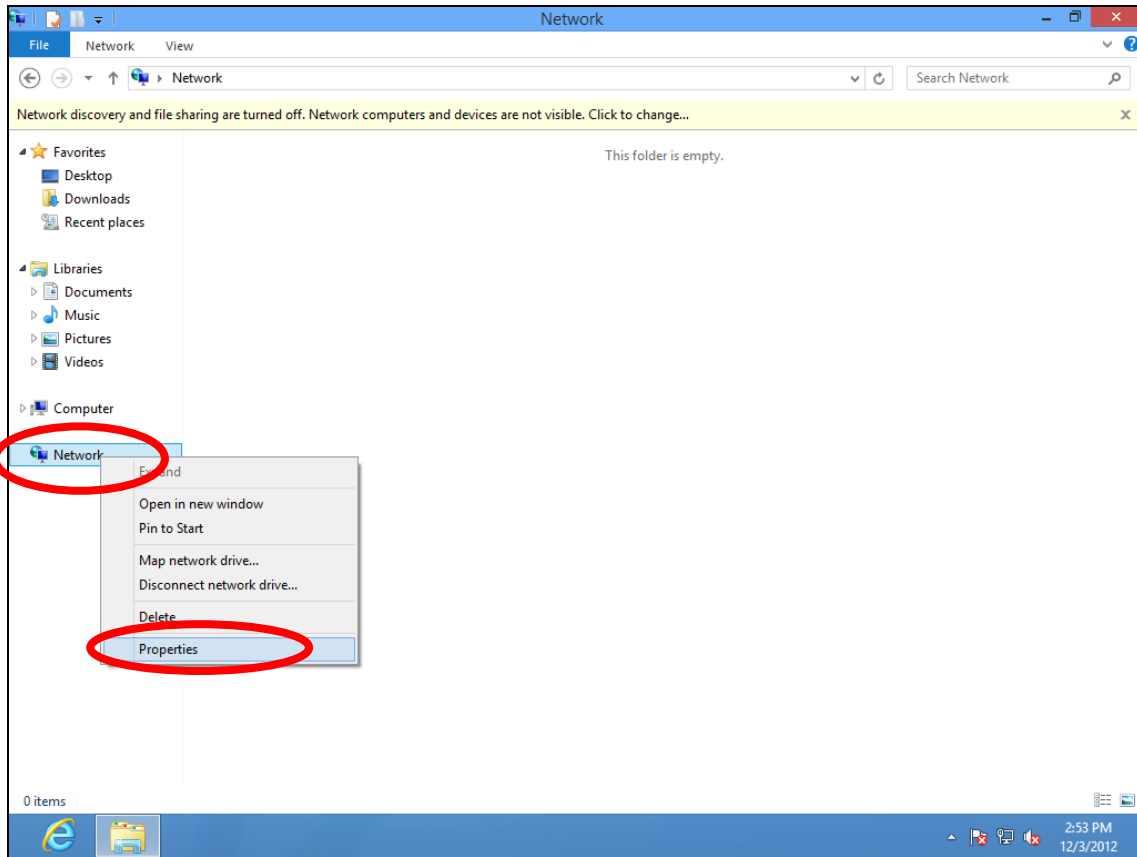

4. In the window that opens, select “Change adapter settings” from the left side.

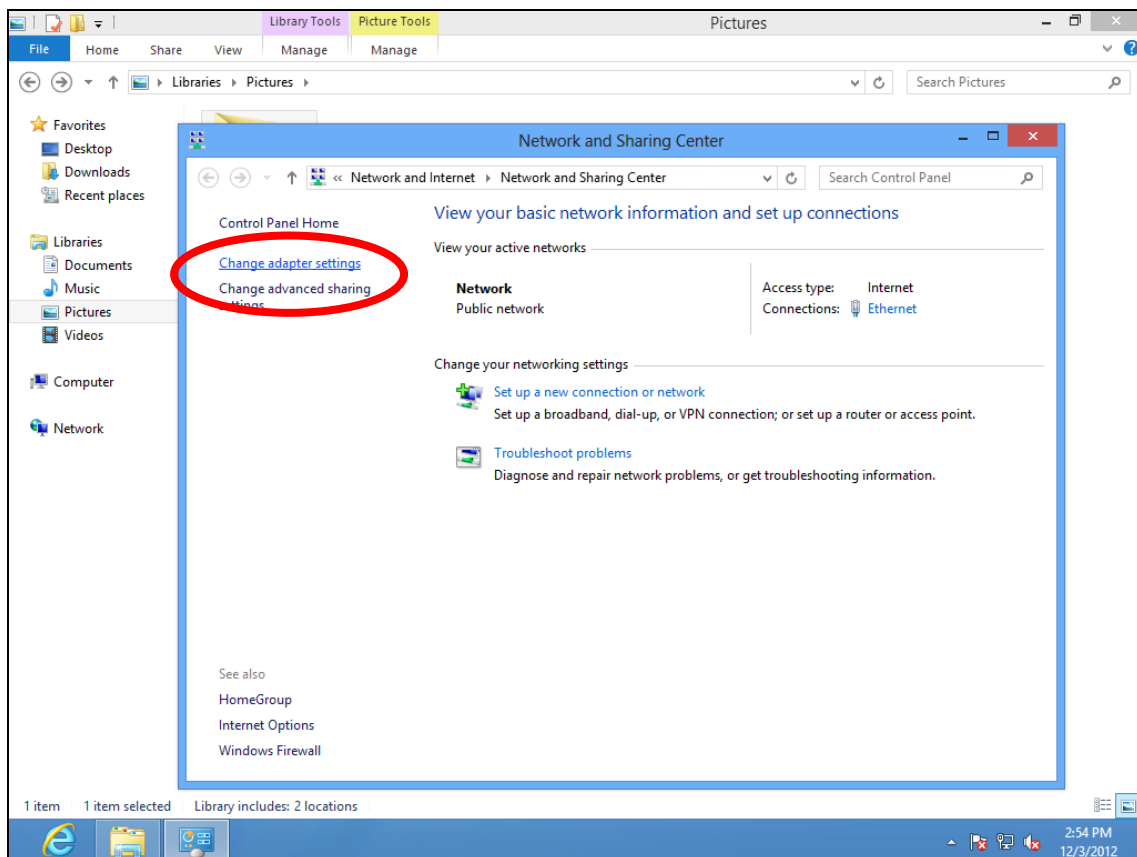

5. Choose your connection and right click, then select "Properties".

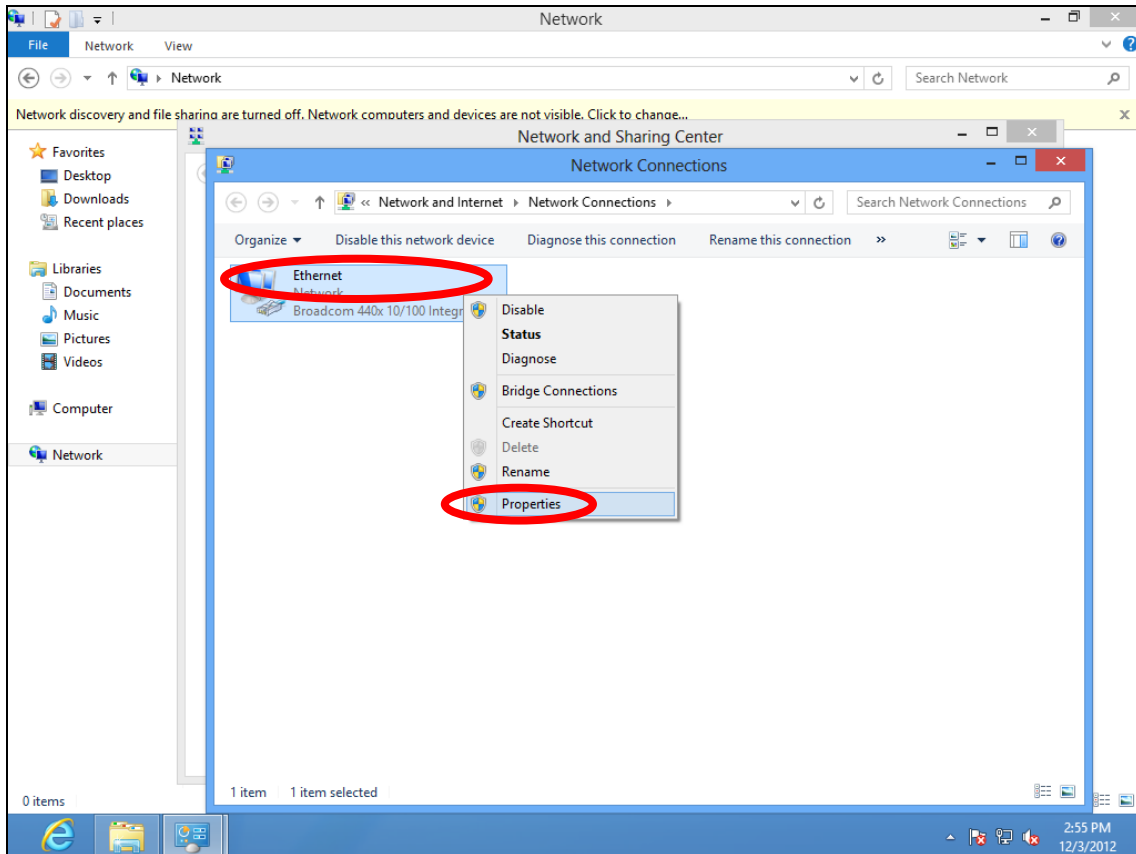

6. Select "Internet Protocol Version 4 (TCP/IPv4)" and then click "Properties".

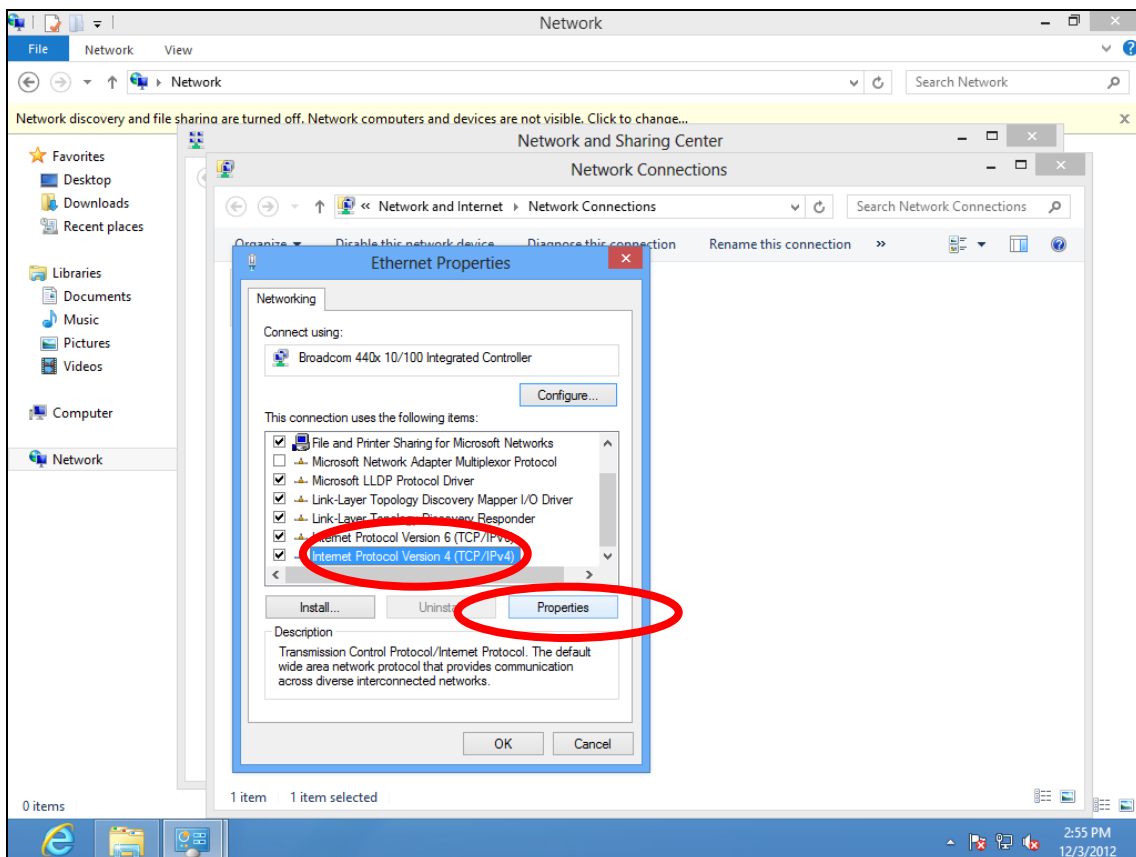

7. Select “Use the following IP address” and “Use the following DNS server addresses”, then input the following values:



Your existing static IP address will be displayed in the “IP address” field before you replace it. Please make a note of this IP address, subnet mask, default gateway and DNS server addresses.

IP address: 192.168.2.10

Subnet Mask: 255.255.255.0

Preferred DNS Server: 192.168.2.1

Click ‘OK’ when finished.

IV-1-2-3. Windows 10

1. From the Windows 10 Start screen, click on “Start” and select “Settings”.

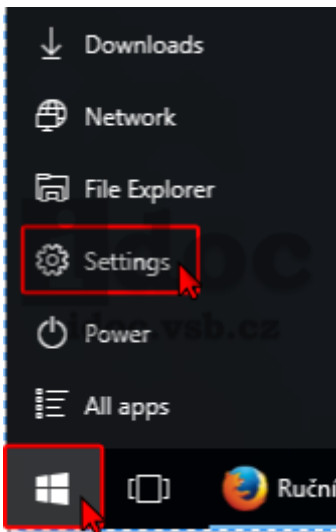

2. Choose “Network & Internet”, then select “Network sharing center, Click “Change adapter settings”. Choose “Ethernet”, click right mouse button and choose “Properties”.

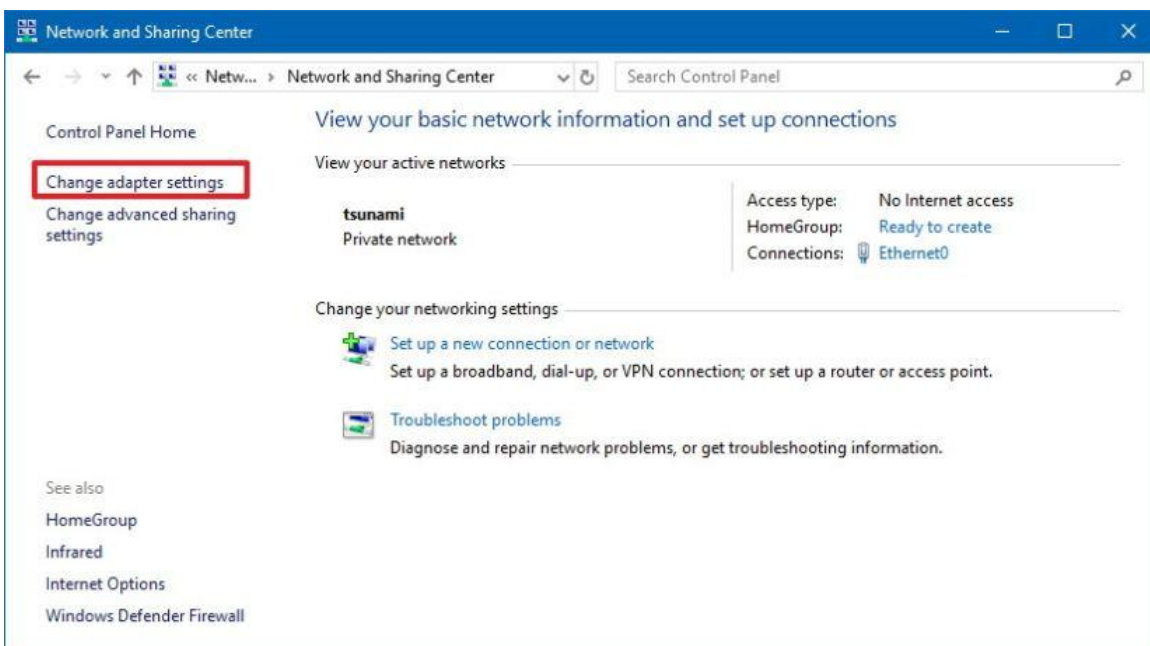

3. Right click the desired network connection and select “Properties”. Then Select the Internet Protocol Version 4 (TCP/IPv4) option. Click up “Properties”.

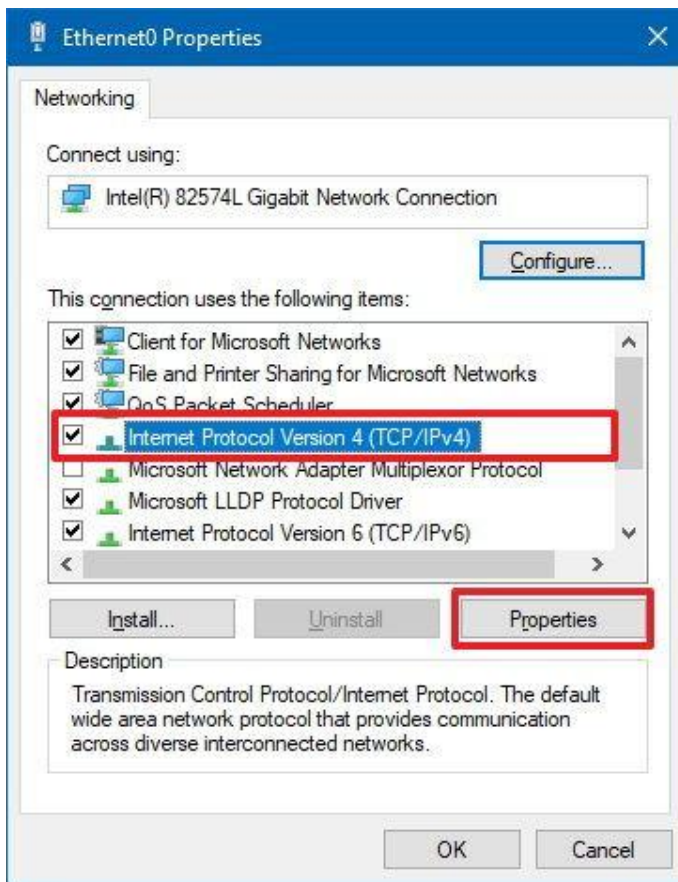

4. Select “Use the following IP address” and “Use the following DNS server addresses”, then input the following values:

 ***Your existing static IP address will be displayed in the “IP address” field before you replace it. Please make a note of this IP address, subnet mask, default gateway and DNS server addresses.***

IP address: 192.168.2.10

Subnet Mask: 255.255.255.0

Preferred DNS Server: 192.168.2.1

Click ‘OK’ when finished.

IV-1-2-4. Mac

1. Have your Macintosh computer operate as usual, and click on “System Preferences”

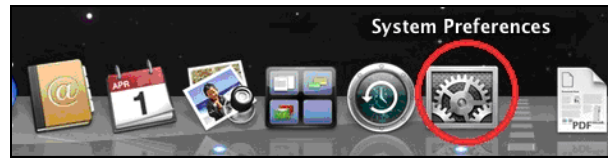

2. In System Preferences, click on “Network”.



3. Click on “Wi-Fi” in the left panel and then click “Advanced” in the lower right corner.

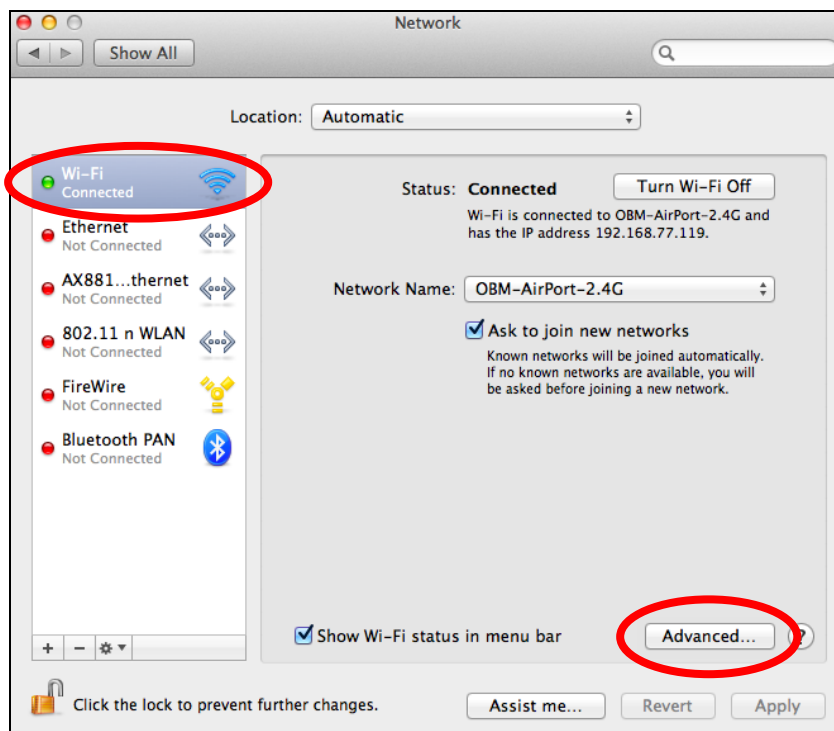

4. Select “TCP/IP” from the top menu and select “Manually” from the drop down menu labeled “Configure IPv4”, then click “OK”.

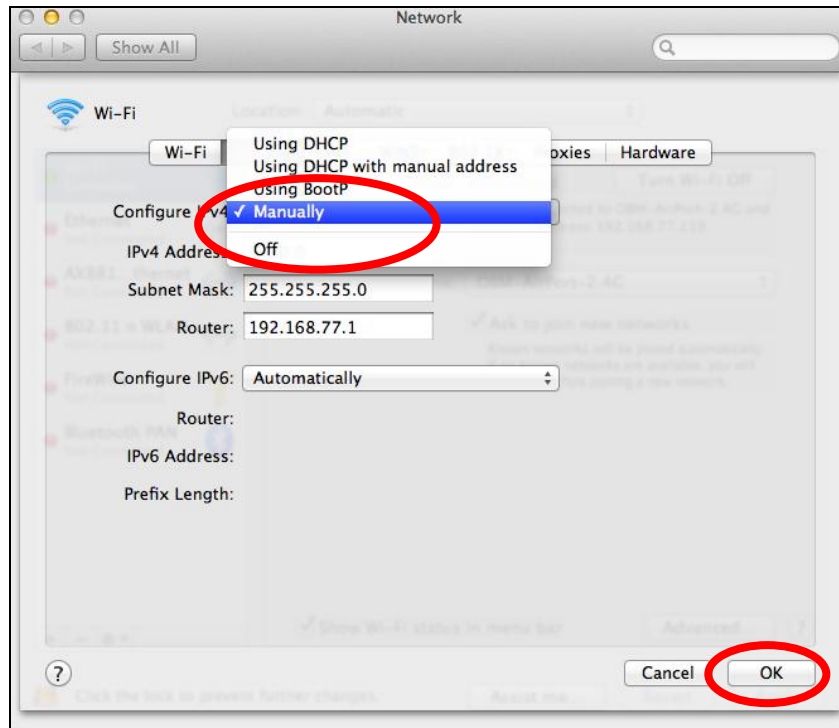

 **Your existing static IP address will be displayed in the “IP address” field before you replace it. Please make a note of this IP address, subnet mask, default gateway and DNS server addresses.**

5. In the “IPv4 Address” and “Subnet Mask” field enter IP address 192.168.2.10 and subnet mask 255.255.255.0. Click on “OK”.

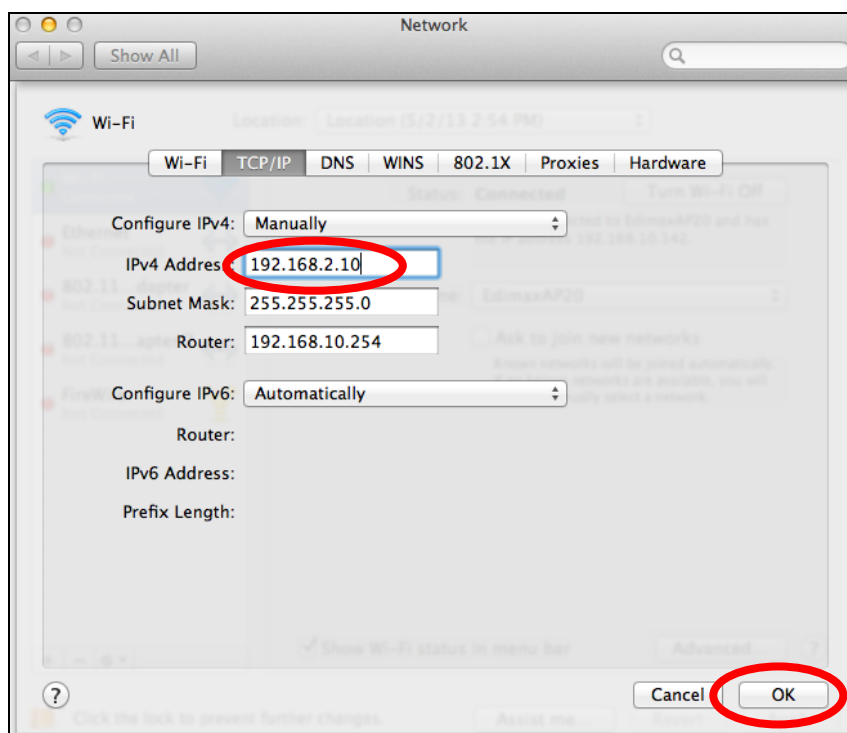

6. Click “Apply” to save the changes.

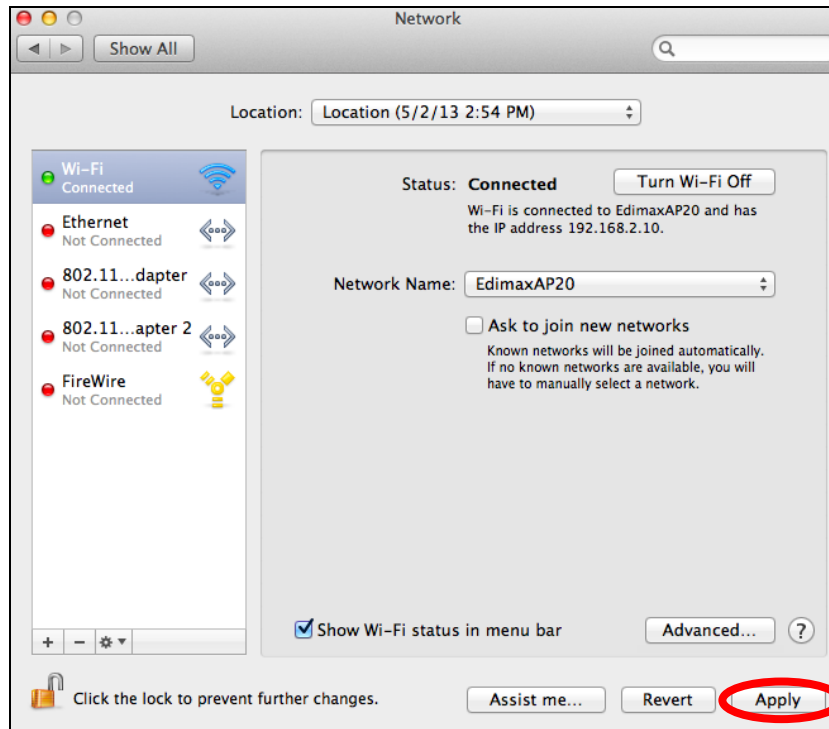

IV-1-3. How to Find Your Network Security Key

To find your network security key, please follow the instructions appropriate for your operating system.

 ***If you are using Windows XP or earlier, please contact your ISP or router manufacturer to find your network security key.***

IV-1-3-1. Windows 7 & 8

1. Open “Control Panel” and click on “Network and Internet” in the top menu.

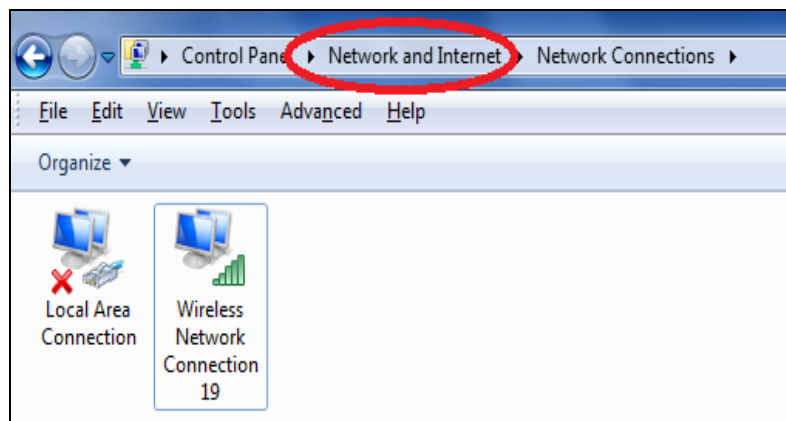

2. Click on “View network status and tasks” which is under the heading “Network and Sharing Center”.

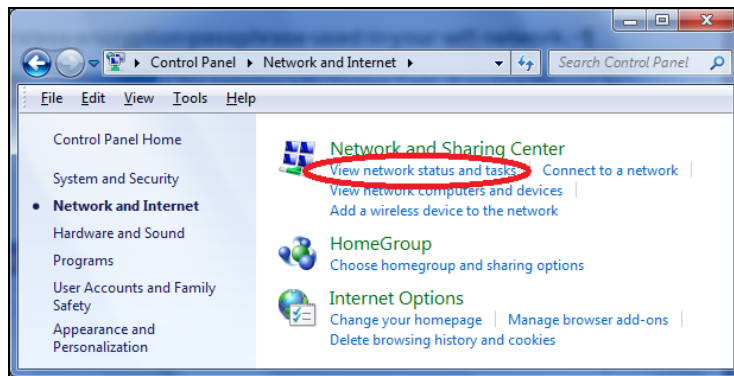

3. Click on “Manage wireless networks” in the left menu.

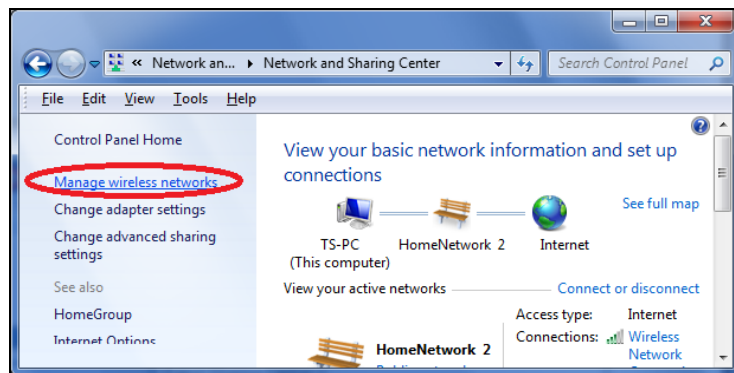

4. You should see the profile of your Wi-Fi network in the list. Right click on your Wi-Fi network and then click on “Properties”.

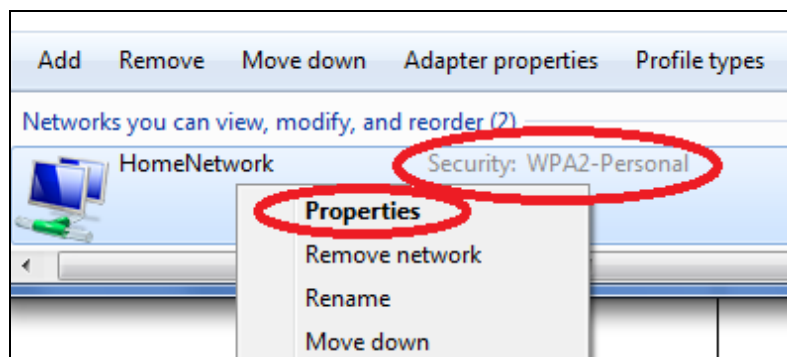

5. Click on the “Security” tab, and then check the box labeled “Show characters”. This will show your network security key. Click the “Cancel” button to close the window.

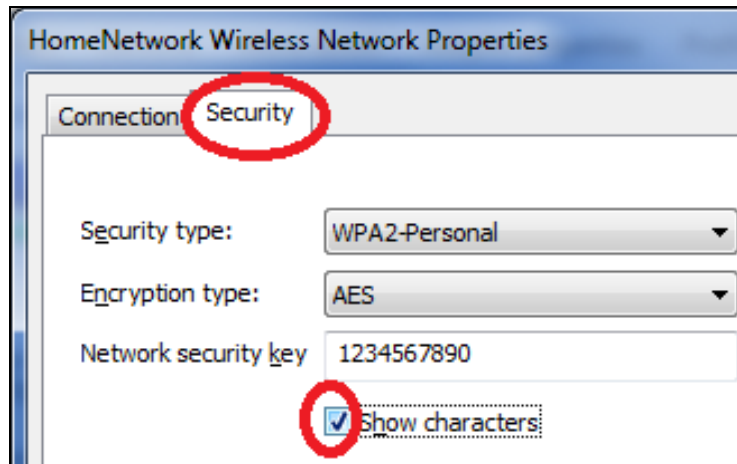

IV-1-3-2. Windows 10

1. Click on “Start” button, select “Settings” and click on “Network and Internet”, “Status” then “Network and Sharing Center”. Now click on “Change adapter settings” on the left hand menu.

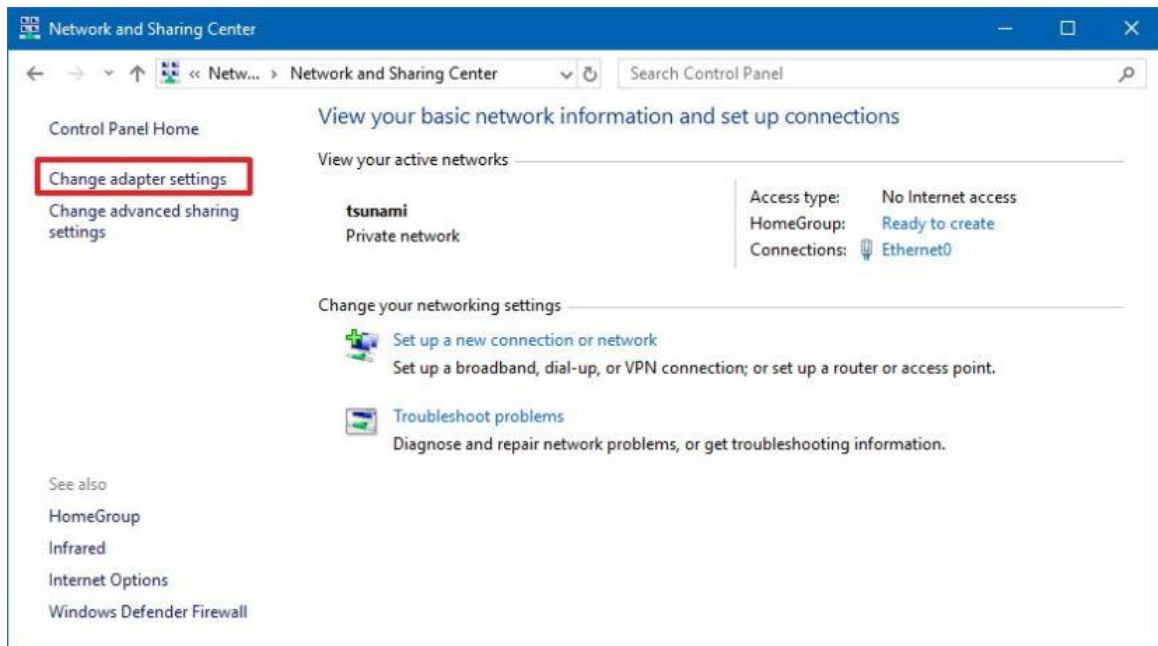

2. You should see the profile of your Wi-Fi network in the list. Right click on your Wi-Fi network and then click on “Status”.

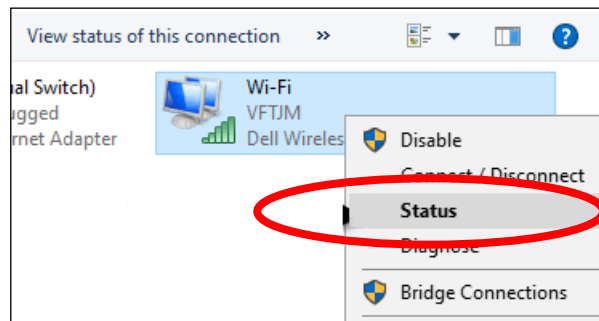

3. The Wi-Fi Status window pop up and click on “Wireless Properties”.

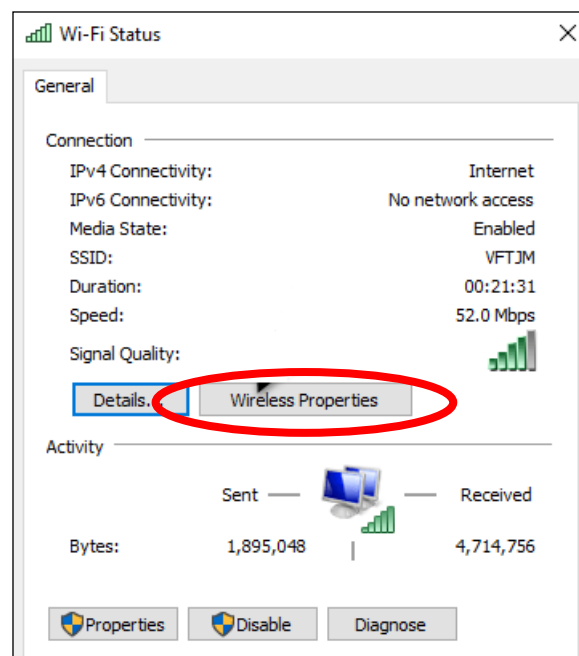

4. Click on the “Security” Tab in the pop-up window that appears and check the “Show characters” checkbox. This will show your network security key. Click the “Cancel” button to close the window.

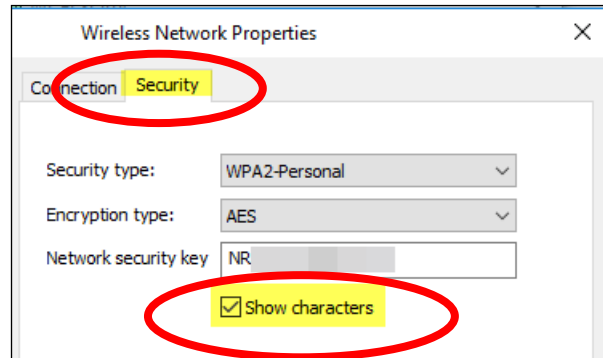

IV-1-3-3. Mac

1. Open a new Finder window, and select “Applications” from the menu on the left side. Open the folder labeled “Utilities” and then open the application “Keychain Access”.

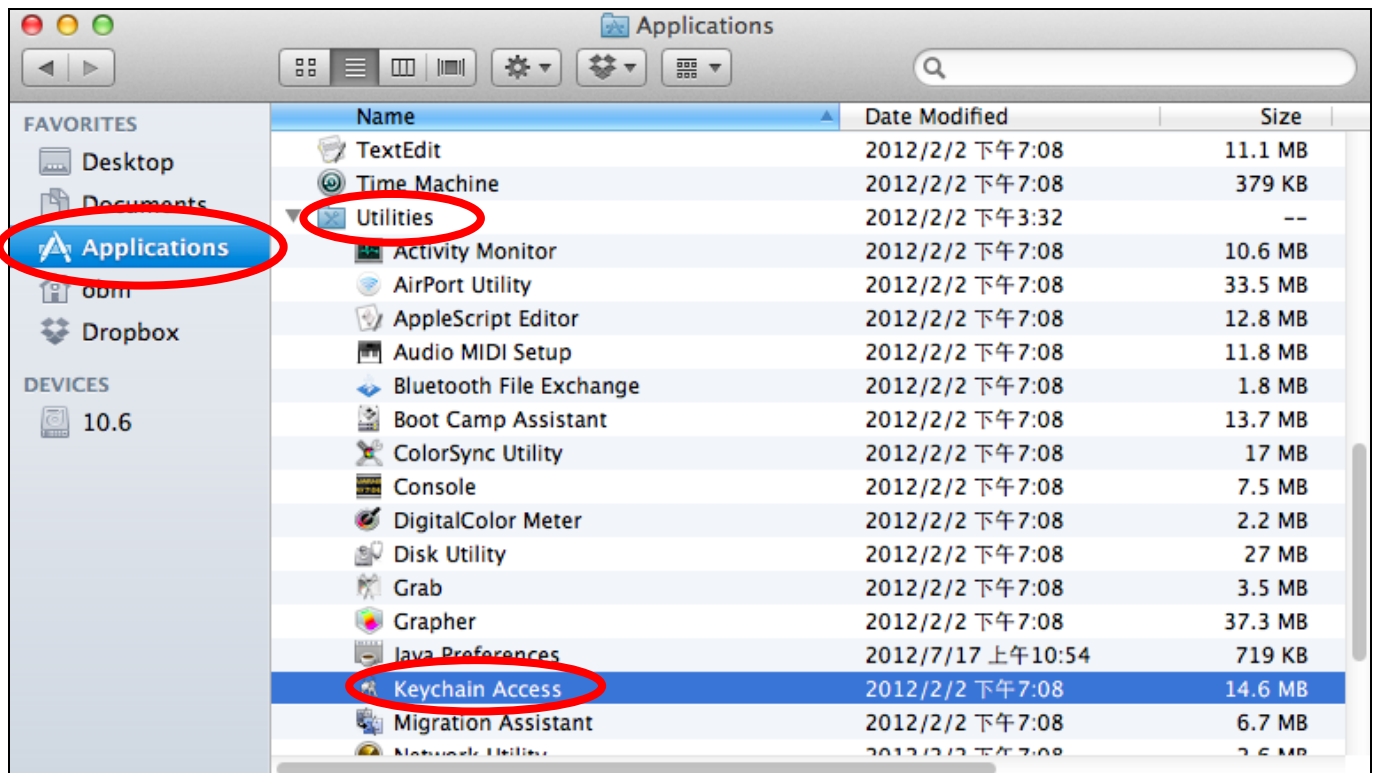

2. Select “Passwords” from the sub-menu labeled “Category” on the left side, as shown below. Then search the list in the main panel for the SSID of your network. In this example, the SSID is “EdimaxWireless” – though your SSID will be unique to your network.

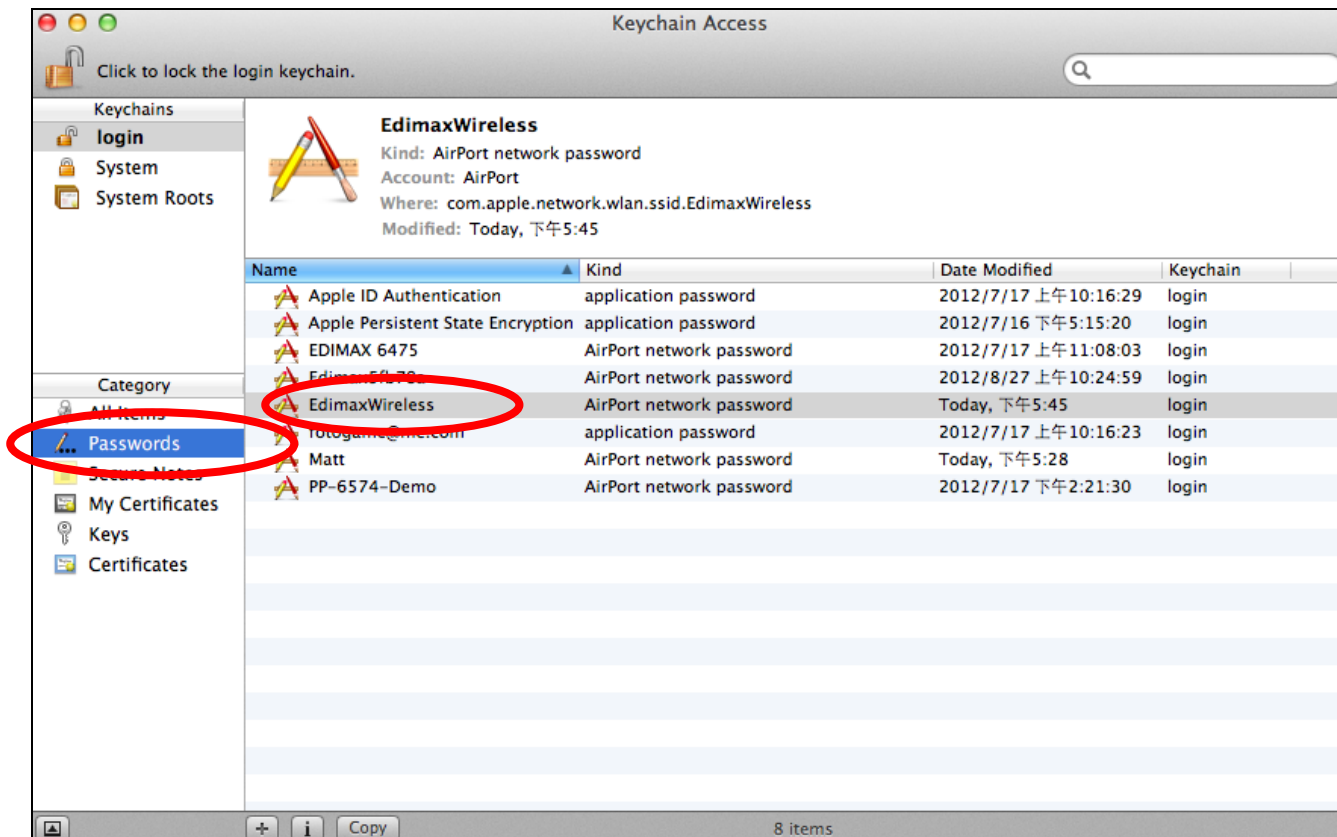

3. Double click the SSID of your network and you will see the following window.

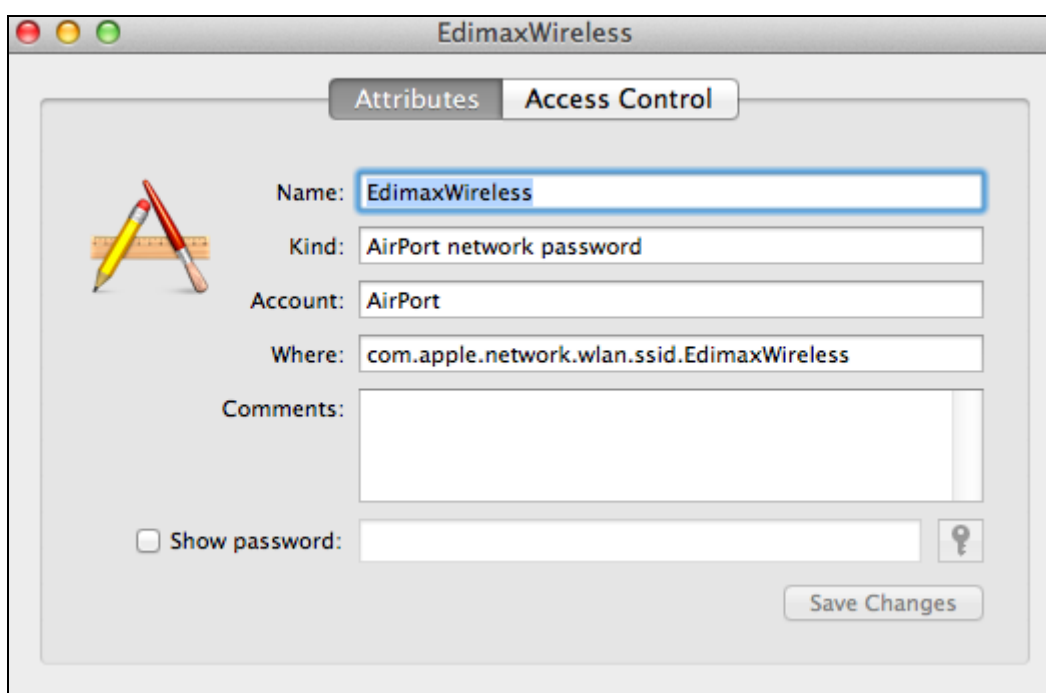

4. Check the box labeled “Show password” and you will be asked to enter your administrative password, which you use to log into your Mac. Enter your password and click “Allow”.

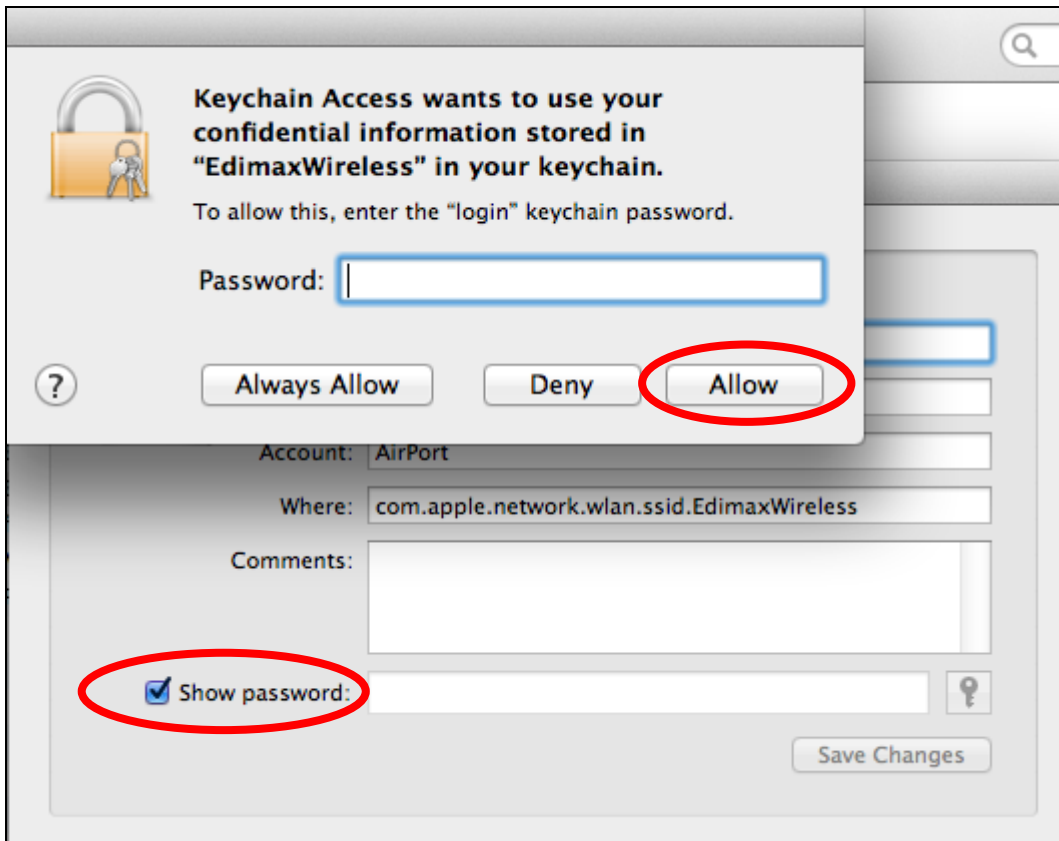

Your network security password will now be displayed in the field next to the box labeled “Show password”. In the example below, the network security password is “edimax1234”. Please make a note of your network security password.

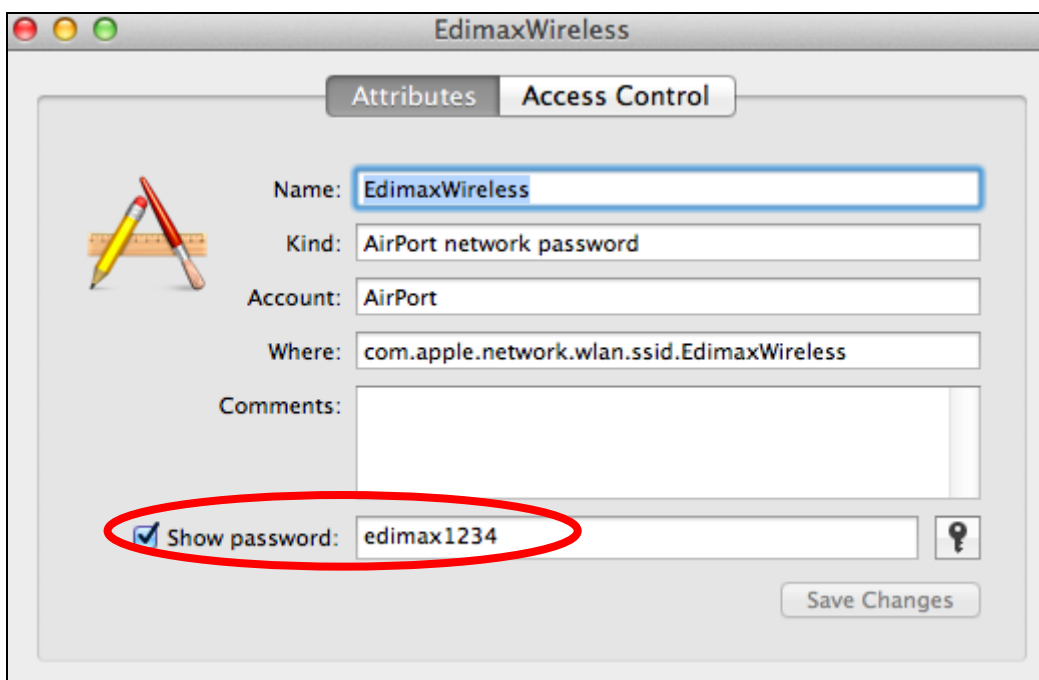

IV-1-4. How to Find Your Router's IP Address

To find your router's IP address, please follow the instructions appropriate for your operating system.

IV-1-4-1. Windows 7

1. Go to "Start", select "Run" and type "cmd", then press Enter or click "OK".

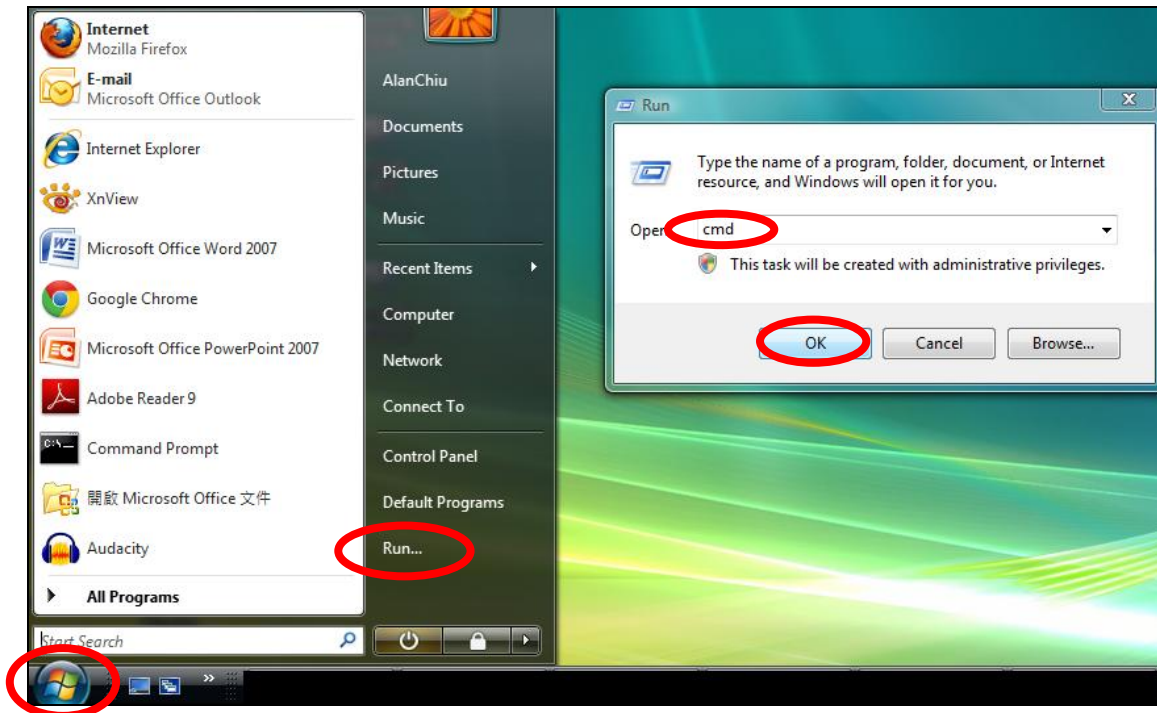

2. A new window will open, type "ipconfig" and press Enter.

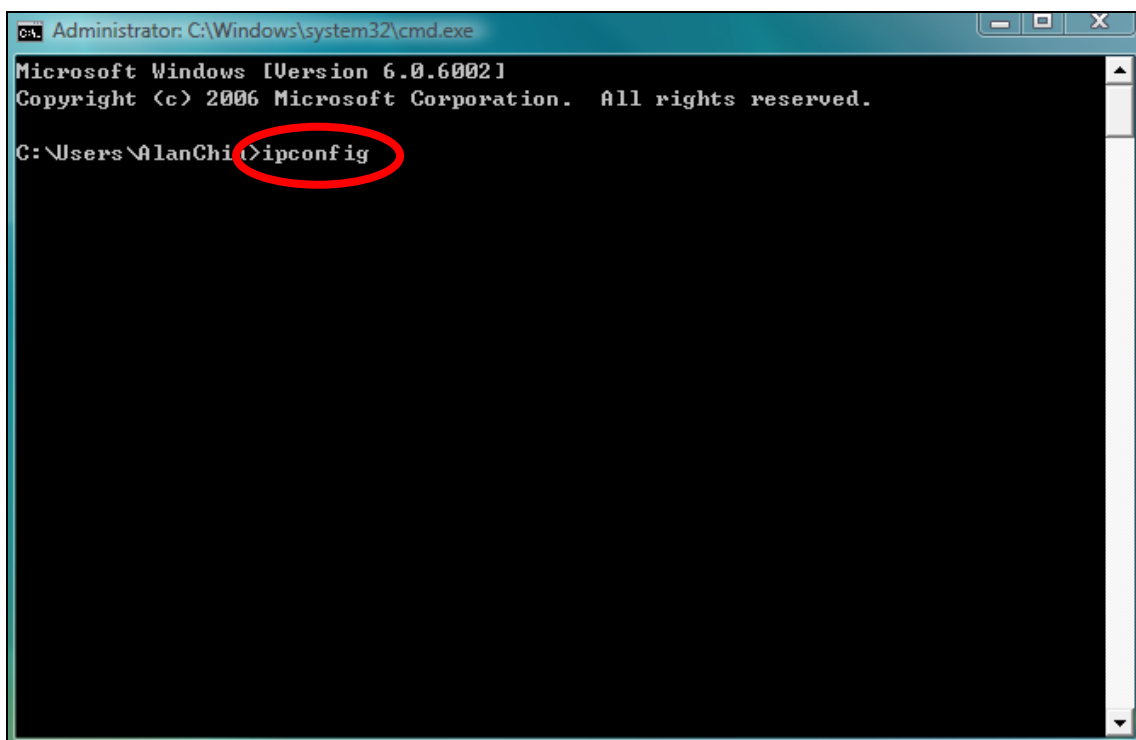

3. Your router's IP address will be displayed next to "Default Gateway".

```
Administrator: C:\Windows\system32\cmd.exe
Ethernet adapter 區域連線:

    Connection-specific DNS Suffix  . : 
    Link-local IPv6 Address . . . . . : fe80::4cdc:3e90:ba56:1722%9
    IPv4 Address. . . . . : 192.168.10.14
    Subnet Mask . . . . . : 255.255.255.0
    Default Gateway . . . . . : fe80::1867:2a1b:e9c2:e57b%9
                                192.168.10.254

Wireless LAN adapter 無線網路連線:

    Media State . . . . . : Media disconnected
    Connection-specific DNS Suffix  . : edimax.com

Tunnel adapter 區域連線* 6:

    Media State . . . . . : Media disconnected
    Connection-specific DNS Suffix  . : 

Tunnel adapter 區域連線* 7:

    Media State . . . . . : Media disconnected
    Connection-specific DNS Suffix  . : 

C:\Users\AlanChiu>
```

IV-1-4-2. Windows 8

1. From the Windows 8 Start screen, move your cursor to the top right corner of the screen to display the Charms bar.



2. Click "Search" and enter "cmd" into the search bar. Click the "Command Prompt" app which be displayed on the left side.

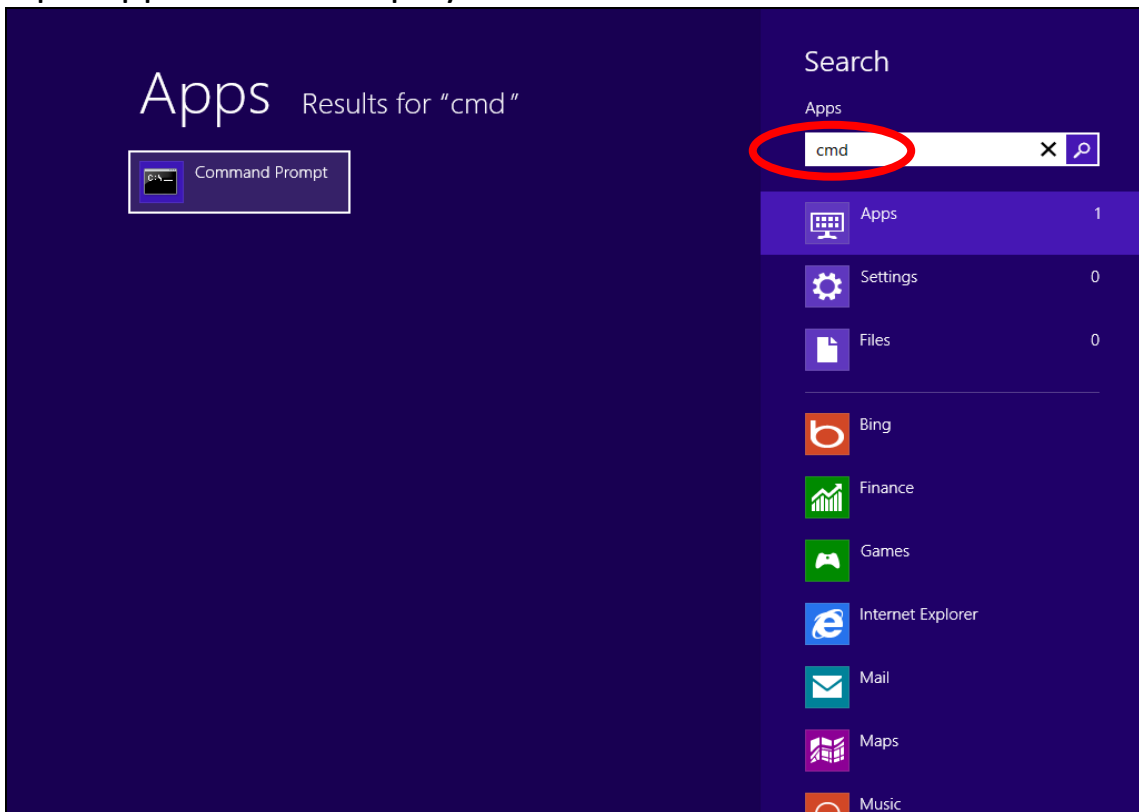

3. A new window will open, type "ipconfig" and press Enter.

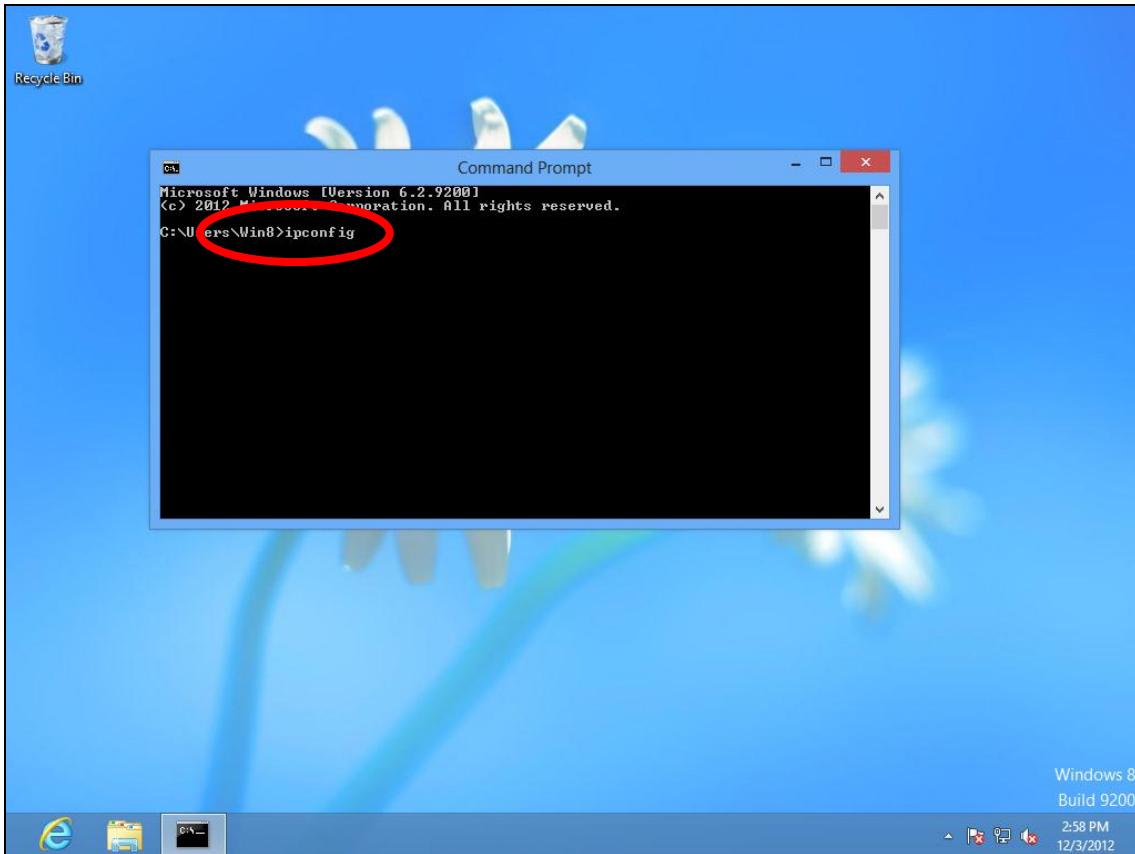

4. Your router's IP address will be displayed next to "Default Gateway".

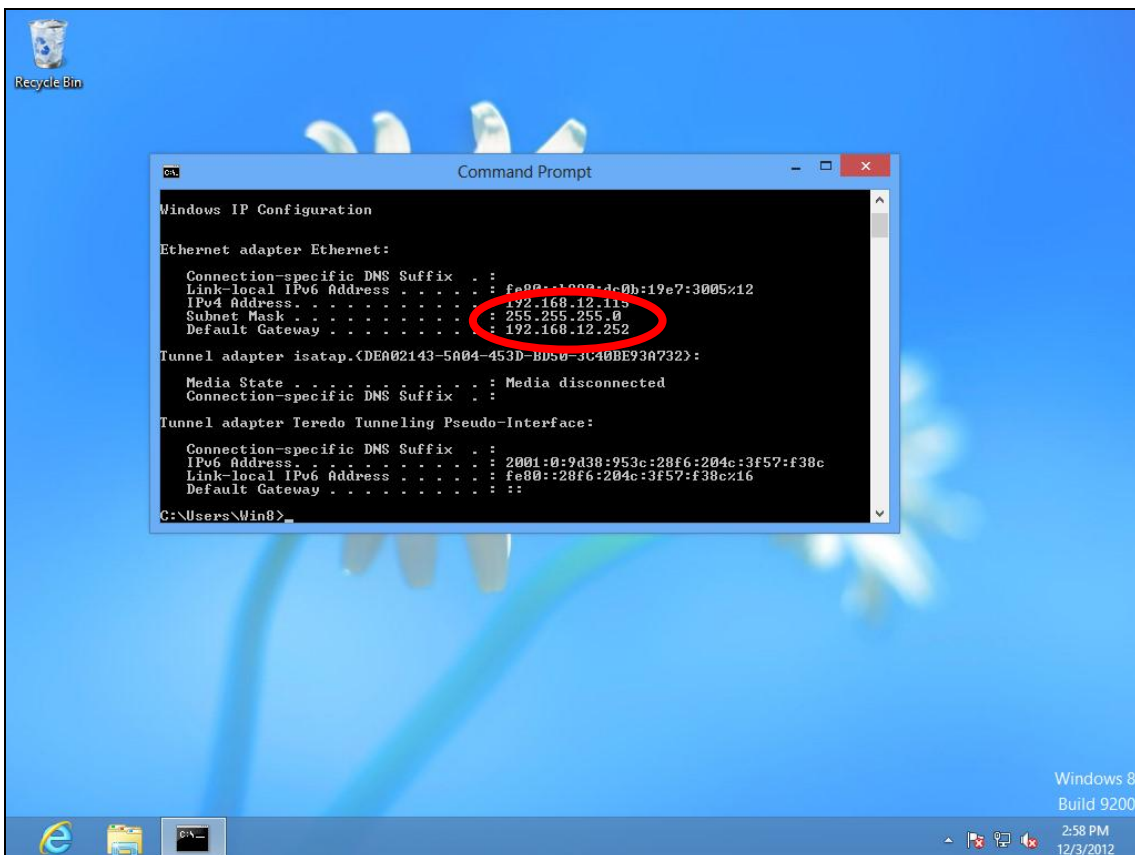

IV-1-4-3. Window 10

1. Right click on “Start” button and select “Command Prompt”.

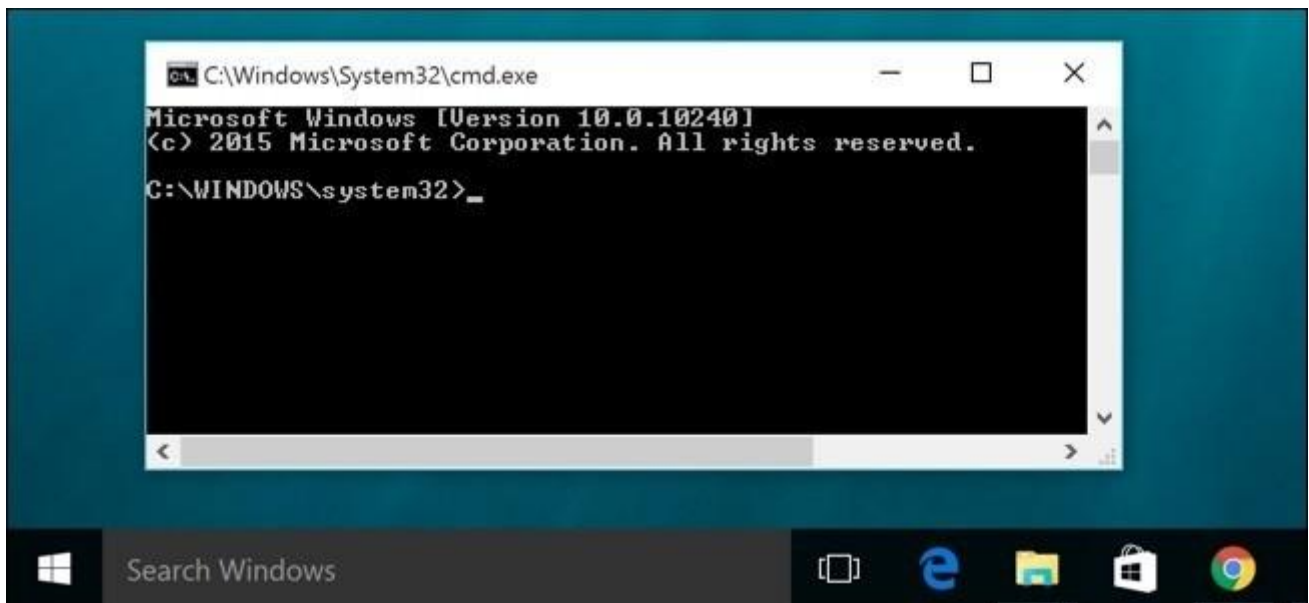

2. On the Command Prompt window, enter “ipconfig” and press the Enter key.

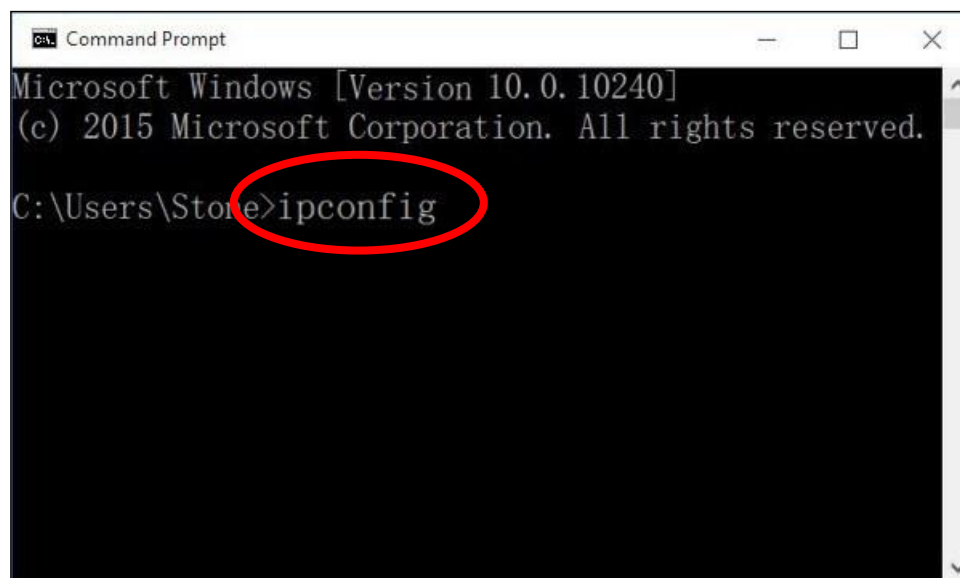

3. Your router's IP address will be displayed next to "Default Gateway".

```
Command Prompt
Microsoft Windows [Version 10.0.10056]
(c) 2015 Microsoft Corporation. All rights reserved.

C:\Users\Win10>ipconfig

Windows IP Configuration

Ethernet adapter Ethernet0:

    Connection-specific DNS Suffix . . . : localdomain
    Link-local IPv6 Address . . . . . : fe80::9538:aa73
    IPv4 Address. . . . . : 192.168.40.128
    Subnet Mask . . . . . : 255.255.255.0
    Default Gateway . . . . . : 192.168.40.2
```

IV-1-4-4. Mac

1. Launch "System Preferences" and click on "Network".
2. If you are using an Ethernet cable to connect to your network, your router's IP address will be displayed next to "Router".

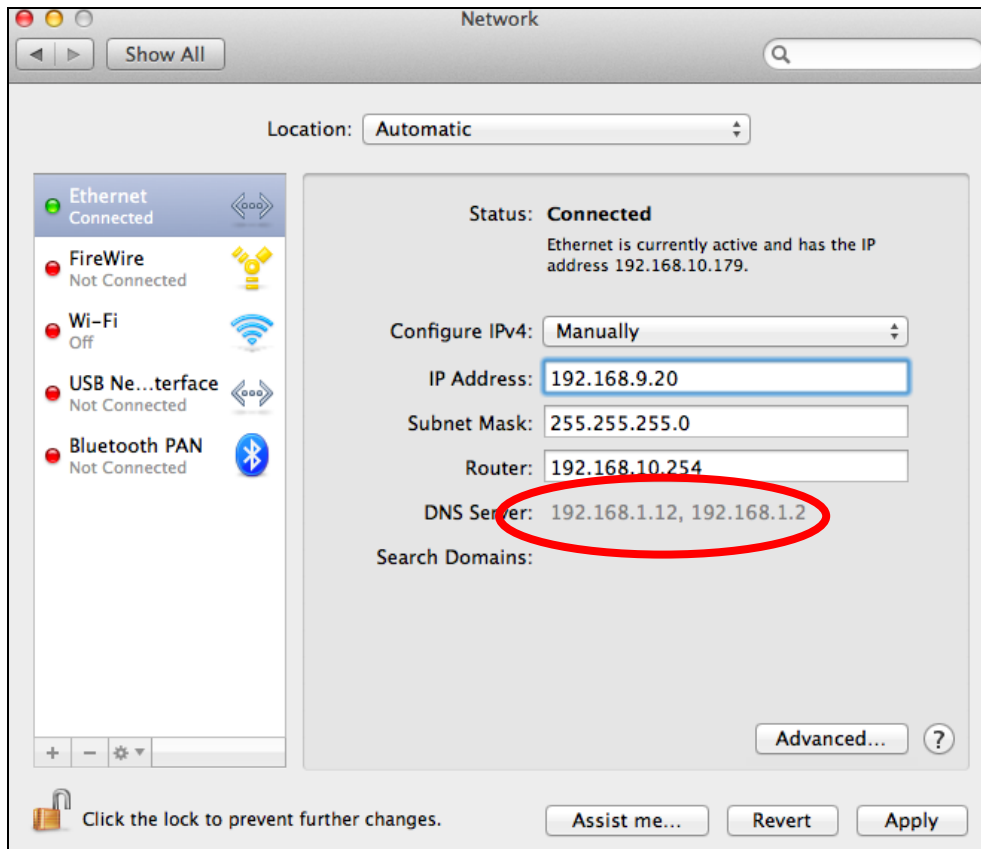

3. If you are using Wi-Fi, click “Wi-Fi” in the left panel, and then “Advanced” in the bottom right corner.

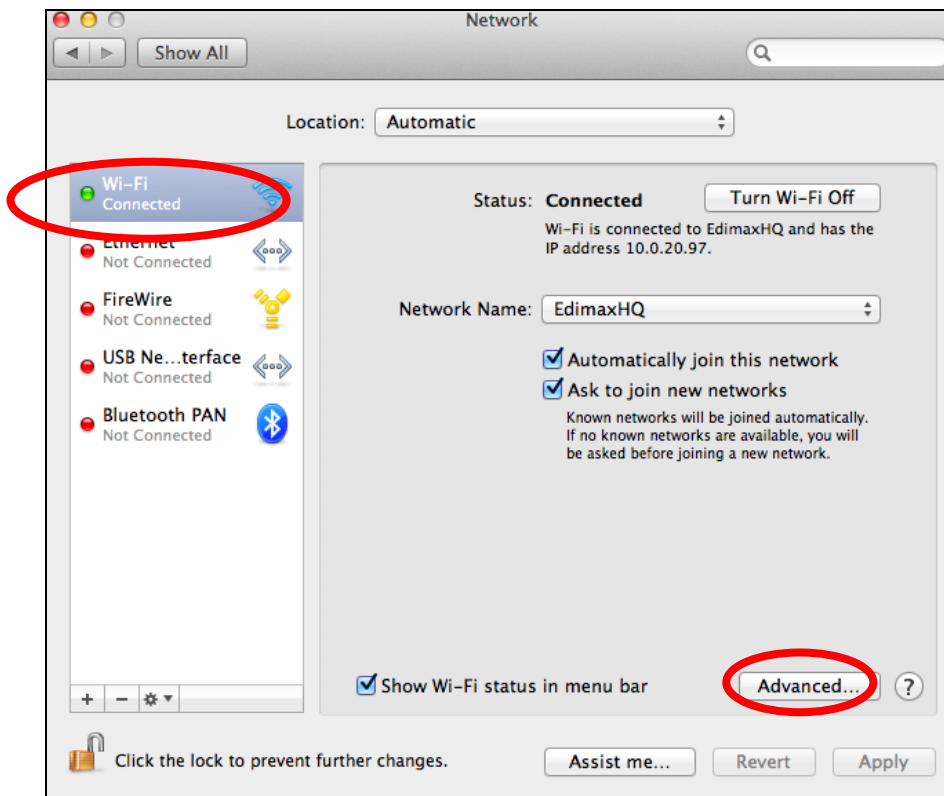

4. Click the “TCP/IP” tab and your router’s IP address will be displayed next to “Router”.

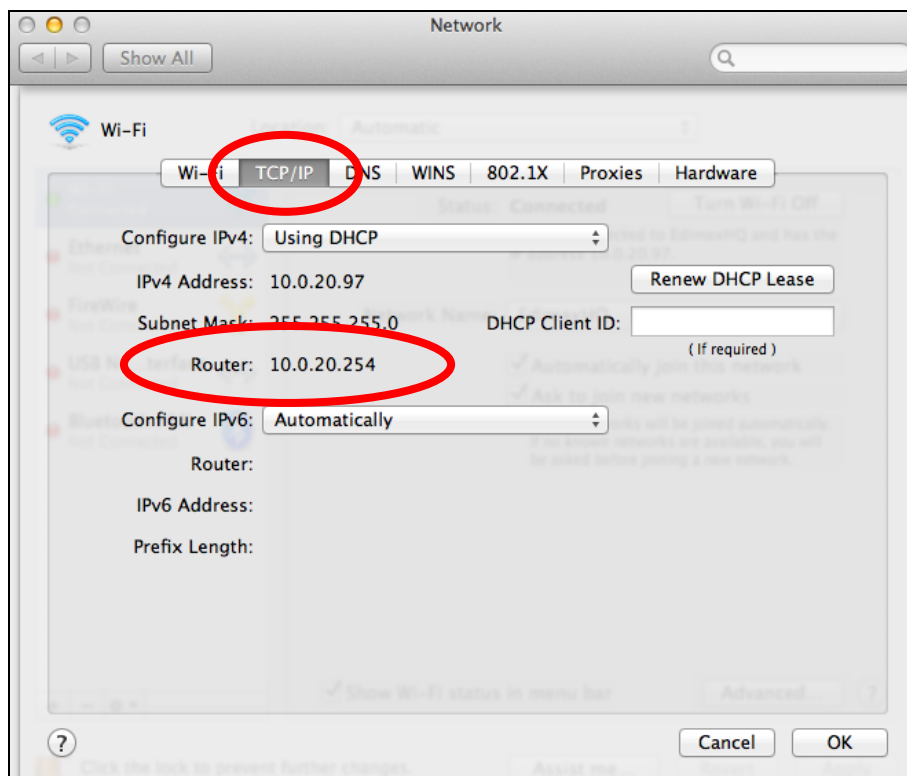

IV-2. Connecting to a Wi-Fi network

For help connecting to your device's **Edimax.Setup** SSID for initial setup, or to connect to your device's new Wi-Fi network (SSID) after setup is complete, follow the guide below:

 **Below is an example of how to connect using Windows 7 – the process may vary slightly for other versions of Windows.**

1. Click the network icon (,  or ) in the system tray and a window with available network connections will open.

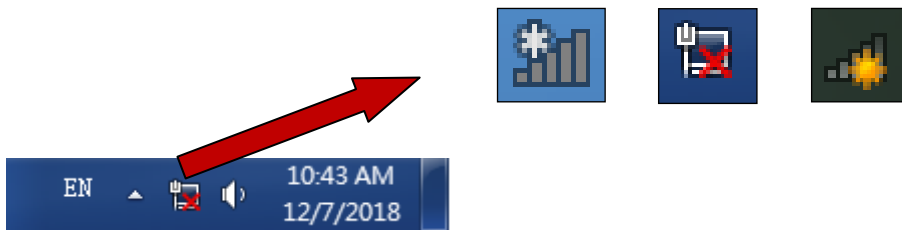

2. Search for the SSID of your BR-6428nS V5 and then click “Connect”. If you set a password for your network, you will then be prompted to enter it.

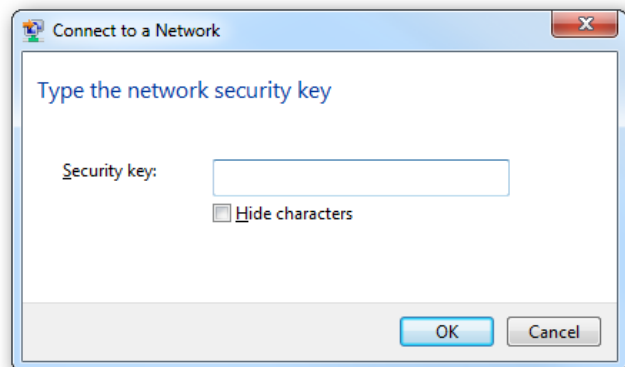
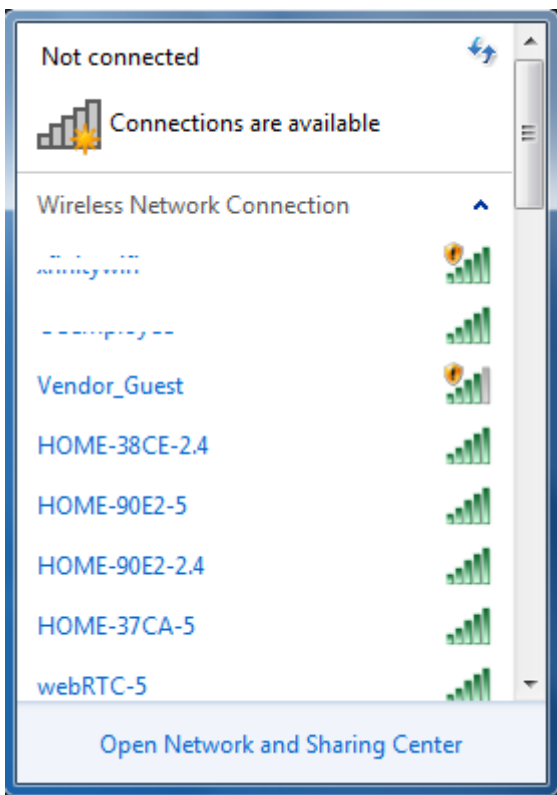

3. After correctly entering your password, you will be successfully connected to the BR-6428nS V5's wireless network.

IV-3. Troubleshooting

If you are experiencing problems with your BR-6428nS V5, please check below before contacting your dealer of purchase for help.



If you are experiencing problems immediately after a firmware upgrade, please contact your dealer of purchase for help.

1. The System LED does not light up.

- a. Make sure that the Router Adapter is properly plugged into a power outlet.
- b. Make sure the power outlet is active (working) by plugging another electric device into it.
- c. Re-plug the Router Adapter to the power outlet. If the system LED is still failed to light up, contact your local dealer for technical support.

2. The WAN LED does not light up.

- a. Make sure that the Ethernet cable (RJ-45) is properly connected to the Router Adapter's Ethernet port.
- b. Make sure that the other end of the Ethernet cable (RJ-45) is properly connected to the computer LAN card or to your Cable/xDSL Ethernet port.
- c. Make sure your computer LAN card is properly installed and configured.
- d. Make sure your Cable/xDSL broadband access is working and configured correctly.
- e. Contact your local dealer for technical support if the Ethernet LED is still failed to light up after the above procedures.

3. I can't access the Internet.

- f. Ensure that all cables are connected properly. Try a different Ethernet cable.
- g. Check if you can access the web based configuration interface. If not, please ensure your computer is set to use a dynamic IP address. Refer to the user manual for guidance if you are unsure how to do this.
- h. Login to the web based configuration interface and go to **Internet > WAN Setup** and check that the connection type is correct. If you are unsure which internet connection type you have, please contact your Internet Service Provider (ISP).
- i. Connect your computer directly to your modem and check if you can access the internet. If you can't, please contact your Internet service provider for assistance.

4. I can't open the web based configuration interface.

- a. Please ensure your computer is set to use a dynamic IP address. Refer to the user manual for guidance if you are unsure how to do this.

5. How do I reset my device to factory default settings?

- a. To reset the device back to its factory default settings, press and hold the WPS/Reset button for over 10 seconds, until the power LED begins to flash. Please wait a few minutes for the product to restart. When the device restarts, all settings will be reset. Default settings are displayed on the product label on the back of the device.

6. My network is configured to use static IP addresses. How can I assign a static IP address to my BR-6428nS V5?

If your ISP gives you a fixed or static IP address for Internet connection, you will need to gather the following information:

- a. IP Address
- b. Subnet Mask
- c. Gateway
- d. DNS Server
- e. Alternate DNS Server (Optional)

7. I forgot my password.

- a. Reset the router to its factory default settings and use the default username admin and default password admin. Default settings are displayed on the product label on the back of the device, as shown above.

8. Remove Wireless Network from Your PC.

- a. If you change wireless settings on your wireless device, you must remove them accordingly from your PC; otherwise, you may not be able to wirelessly connect to this device. Below describes how to remove a wireless network from your PC.

Windows 7

Step 1: Right-click the Network icon and select Properties.

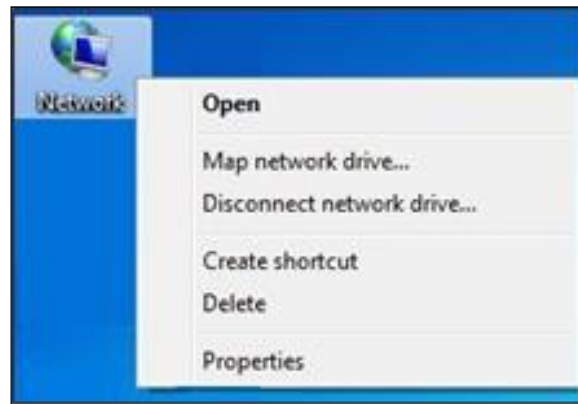

Step 2: Select Manage Wireless Networks.



Step 3: Select the wireless network and click Remove network.



COPYRIGHT

Copyright © Edimax Technology Co., Ltd. all rights reserved. No part of this publication may be reproduced, transmitted, transcribed, stored in a retrieval system, or translated into any language or computer language, in any form or by any means, electronic, mechanical, magnetic, optical, chemical, manual or otherwise, without the prior written permission from Edimax Technology Co., Ltd.

Edimax Technology Co., Ltd. makes no representations or warranties, either expressed or implied, with respect to the contents hereof and specifically disclaims any warranties, merchantability, or fitness for any particular purpose. Any software described in this manual is sold or licensed as is. Should the programs prove defective following their purchase, the buyer (and not this company, its distributor, or its dealer) assumes the entire cost of all necessary servicing, repair, and any incidental or consequential damages resulting from any defect in the software. Edimax Technology Co., Ltd. reserves the right to revise this publication and to make changes from time to time in the contents hereof without the obligation to notify any person of such revision or changes.

The product you have purchased and the setup screen may appear slightly different from those shown in this QIG. The software and specifications are subject to change without notice. Please visit our website www.edimax.com for updates. All brand and product names mentioned in this manual are trademarks and/or registered trademarks of their respective holders.

Federal Communication Commission Interference Statement

This equipment has been tested and found to comply with the limits for a Class B digital device, pursuant to Part 15 of FCC Rules. These limits are designed to provide reasonable protection against harmful interference in a residential installation. This equipment generates, uses, and can radiate radio frequency energy and, if not installed and used in accordance with the instructions, may cause harmful interference to radio communications. However, there is no guarantee that interference will not occur in a particular installation. If this equipment does cause harmful interference to radio or television reception, which can be determined by turning the equipment off and on, the user is encouraged to try to correct the interference by one or more of the following measures:

1. Reorient or relocate the receiving antenna.
2. Increase the separation between the equipment and receiver.
3. Connect the equipment into an outlet on a circuit different from that to which the receiver is connected.
4. Consult the dealer or an experienced radio technician for help.

FCC Caution

This device and its antenna must not be co-located or operating in conjunction with any other antenna or transmitter. This device complies with Part 15 of the FCC Rules. Operation is subject to the following two conditions: (1) this device may not cause harmful interference, and (2) this device must accept any interference received, including interference that may cause undesired operation. Any changes or modifications not expressly approved by the party responsible for compliance could void the authority to operate equipment.

Federal Communications Commission (FCC) Radiation Exposure Statement

This equipment complies with FCC radiation exposure set forth for an uncontrolled environment. In order to avoid the possibility of exceeding the FCC radio frequency exposure limits, human proximity to the antenna shall not be less than 2.5cm (1 inch) during normal operation.

Federal Communications Commission (FCC) RF Exposure Requirements

SAR compliance has been established in the laptop computer(s) configurations with PCMCIA slot on the side near the center, as tested in the application for certification, and can be used in laptop computer(s) with substantially similar physical dimensions, construction, and electrical and RF characteristics. Use in other devices such as PDAs or lap pads is not authorized. This transmitter is restricted for use with the specific antenna tested in the application for certification. The antenna(s) used for this transmitter must not be co-located or operating in conjunction with any other antenna or transmitter.

RED Compliance Statement

Compliance with 2014/53/EU Radio Equipment Directive (RED)

In accordance with Article 10.8(a) and 10.8(b) of the RED, the following table provides information on the frequency bands used and the maximum RF transmit power of the product for sale in the EU:

Frequency range (MHz)	Max. Transmit Power (dBm)
2412-2472	19.39 dBm

A simplified DoC shall be provided as follows: Article 10(9)

Hereby, Edimax Technology Co., Ltd. declares that the radio equipment type **300M Wireless Router** is in compliance with Directive 2014/53/EU

The full text of the EU declaration of conformity is available at the following internet address: <http://www.edimax.com/edimax/global/>

Safety

This equipment is designed with the utmost care for the safety of those who install and use it. However, special attention must be paid to the dangers of electric shock and static electricity when working with electrical equipment. All guidelines of this and of the computer manufacture must therefore be allowed at all times to ensure the safe use of the equipment.

EU Countries Intended for Use

The ETSI version of this device is intended for home and office use in Austria, Belgium, Bulgaria, Cyprus, Czech, Denmark, Estonia, Finland, France, Germany, Greece, Hungary, Ireland, Italy, Latvia, Lithuania, Luxembourg, Malta, Netherlands, Poland, Portugal, Romania, Slovakia, Slovenia, Spain, Sweden, Turkey, and United Kingdom. The ETSI version of this device is also authorized for use in EFTA member states: Iceland, Liechtenstein, Norway, and Switzerland.

EU Countries Not Intended for Use

None

EU Declaration of Conformity

- English:** This equipment is in compliance with the essential requirements and other relevant provisions of Directive 2014/53/EU, 2014/35/EU.
- Français:** Cet équipement est conforme aux exigences essentielles et autres dispositions de la directive 2014/53/EU, 2014/35/EU.
- Čeština:** Toto zařízení je v souladu se základními požadavky a ostatními příslušnými ustanoveními směrnic 2014/53/EU, 2014/35/EU.
- Polski:** Urządzenie jest zgodne z ogólnymi wymaganiami oraz szczególnymi warunkami określonymi Dyrektywą UE 2014/53/EU, 2014/35/EU.
- Română:** Acest echipament este în conformitate cu cerințele esențiale și alte prevederi relevante ale Directivei 2014/53/UE, 2014/35/UE.
- Русский:** Это оборудование соответствует основным требованиям и положениям Директивы 2014/53/EU, 2014/35/EU.
- Magyar:** Ez a berendezés megfelel az alapvető követelményeknek és más vonatkozó irányelveknek (2014/53/EU, 2014/35/EU).
- Türkçe:** Bu cihaz 2014/53/EU, 2014/35/EU direktifleri zorunlu istekler ve diğer hükümlerle ile uyumludur.
- Українська:** Обладнання відповідає вимогам і умовам директиви 2014/53/EU, 2014/35/EU.
- Slovenčina:** Toto zariadenie spĺňa základné požiadavky a ďalšie príslušné ustanovenia smerníc 2014/53/EU, 2014/35/EU.
- Deutsch:** Dieses Gerät erfüllt die Voraussetzungen gemäß den Richtlinien 2014/53/EU, 2014/35/EU.
- Español:** El presente equipo cumple los requisitos esenciales de la Directiva 2014/53/EU, 2014/35/EU.
- Italiano:** Questo apparecchio è conforme ai requisiti essenziali e alle altre disposizioni applicabili della Direttiva 2014/53/EU, 2014/35/UE.
- Nederlands:** Dit apparaat voldoet aan de essentiële eisen en andere van toepassing zijnde bepalingen van richtlijn 2014/53/EU, 2014/35/EU.
- Português:** Este equipamento cumpre os requisitos essenciais da Directiva 2014/53/EU, 2014/35/EU.
- Norsk:** Dette utstyret er i samsvar med de viktigste kravene og andre relevante regler i Direktiv 2014/53/EU, 2014/35/EU.
- Svenska:** Denna utrustning är i överensstämmelse med de väsentliga kraven och övriga relevanta bestämmelser i direktiv 2014/53/EU, 2014/35/EU.
- Dansk:** Dette udstyr er i overensstemmelse med de væsentligste krav og andre relevante forordninger i direktiv 2014/53/EU, 2014/35/EU.
- suomen kieli:** Tämä laite täyttää direktiivien 2014/53/EU, 2014/35/EU. oleelliset vaatimukset ja muut asiaankuuluvat määräykset.

FOR USE IN 



WEEE Directive & Product Disposal



At the end of its serviceable life, this product should not be treated as household or general waste. It should be handed over to the applicable collection point for the recycling of electrical and electronic equipment, or returned to the supplier for disposal.

Declaration of Conformity

We, Edimax Technology Co., Ltd., declare under our sole responsibility, that the equipment described below complies with the requirements of the European Radio Equipment directives.

Equipment: 300M wireless router
Model No.: BR-6428nS V5

The following European standards for essential requirements have been followed:

Directives 2014/53/EU

Spectrum : EN 300 328 V2.1.1:2016
EMC : EN 301 489-1 V2.1.1:2017
EN 301 489-17 V3.1.1:2017
EMF : EN 62311:2008

Directives 2014/35/EU

Safety (LVD) : IEC 60950-1:2005 (2nd Edition)+Am 1:2009+Am 2:2013
EN 60950-1:2006+A11:2009+A1:2010+A12:2011+A2:2013

Edimax Technology Europe B.V.
Fijenhof 2,
5652 AE Eindhoven,
The Netherlands

a company of :
Edimax Technology Co., Ltd.
No. 278, Xinhua 1st Rd.,
Neihu Dist., Taipei City,
Taiwan

Signature:

Printed Name: David Huang
Title: Director
Edimax Technology Europe B.V.



Date of Signature: Nov., 2018

Signature:

A handwritten signature in black ink, appearing to read 'Albert Chang', written over a horizontal line.

Printed Name: Albert Chang

Title: Director

Edimax Technology Co., Ltd.

Notice According to GNU General Public License Version 2

This product includes software that is subject to the GNU General Public License version 2. The program is free software and distributed without any warranty of the author. We offer, valid for at least three years, to give you, for a charge no more than the costs of physically performing source distribution, a complete machine-readable copy of the corresponding source code.

Das Produkt beinhaltet Software, die den Bedingungen der GNU/GPL-Version 2 unterliegt. Das Programm ist eine sog. „Free Software“, der Autor stellt das Programm ohne irgendeine Gewährleistungen zur Verfügung. Wir bieten Ihnen für einen Zeitraum von drei Jahren an, eine vollständige maschinenlesbare Kopie des Quelltextes der Programme zur Verfügung zu stellen – zu nicht höheren Kosten als denen, die durch den physikalischen Kopiervorgang anfallen.

GNU GENERAL PUBLIC LICENSE

Version 2, June 1991

Copyright (C) 1989, 1991 Free Software Foundation, Inc. 51 Franklin Street, Fifth Floor, Boston, MA 02110-1301, USA
Everyone is permitted to copy and distribute verbatim copies of this license document, but changing it is not allowed.

Preamble

The licenses for most software are designed to take away your freedom to share and change it. By contrast, the GNU General Public License is intended to guarantee your freedom to share and change free software--to make sure the software is free for all its users. This General Public License applies to most of the Free Software Foundation's software and to any other program whose authors commit to using it. (Some other Free Software Foundation software is covered by the GNU Lesser General Public License instead.) You can apply it to your programs, too.

When we speak of free software, we are referring to freedom, not price. Our General Public Licenses are designed to make sure that you have the freedom to distribute copies of free software (and charge for this service if you wish), that you receive source code or can get it if you want it, that you can change the software or use pieces of it in new free programs; and that you know you can do these things.

To protect your rights, we need to make restrictions that forbid anyone to deny you these rights or to ask you to surrender the rights. These restrictions translate to certain responsibilities for you if you distribute copies of the software, or if you modify it.

For example, if you distribute copies of such a program, whether gratis or for a fee, you must give the recipients all the rights that you have. You must make sure that they, too, receive or can get the source code. And you must show them these terms so they know their rights.

We protect your rights with two steps: (1) copyright the software, and (2) offer you this license which gives you legal permission to copy, distribute and/or modify the software.

Also, for each author's protection and ours, we want to make certain that everyone understands that there is no warranty for this free software. If the software is modified by someone else and passed on, we want its recipients to know that what they have is not the original, so that any problems introduced by others will not reflect on the original authors' reputations.

Finally, any free program is threatened constantly by software patents. We wish to avoid the danger that redistributors of a free program will individually obtain patent licenses, in effect making the program proprietary. To prevent this, we have made it clear that any patent must be licensed for everyone's free use or not licensed at all.

The precise terms and conditions for copying, distribution and modification follow.

TERMS AND CONDITIONS FOR COPYING, DISTRIBUTION AND MODIFICATION

0. This License applies to any program or other work which contains a notice placed by the copyright holder saying it may be distributed under the terms of this General Public License. The "Program", below, refers to any such program or work, and a "work based on the Program" means either the Program or any derivative work under copyright law: that is to say, a work containing the Program or a portion of it, either verbatim or with modifications and/or translated into another language. (Hereinafter, translation is included without limitation in the term "modification".) Each licensee is addressed as "you".

Activities other than copying, distribution and modification are not covered by this License; they are outside its scope. The act of running the Program is not restricted, and the output from the Program is covered only if its contents constitute a work based on the Program (independent of having been made by running the Program). Whether that is true depends on what the Program does.

1. You may copy and distribute verbatim copies of the Program's source code as you receive it, in any medium, provided that you conspicuously and appropriately publish on each copy an appropriate copyright notice and disclaimer of warranty; keep

intact all the notices that refer to this License and to the absence of any warranty; and give any other recipients of the Program a copy of this License along with the Program.

You may charge a fee for the physical act of transferring a copy, and you may at your option offer warranty protection in exchange for a fee.

2. You may modify your copy or copies of the Program or any portion of it, thus forming a work based on the Program, and copy and distribute such modifications or work under the terms of Section 1 above, provided that you also meet all of these conditions:

- a) You must cause the modified files to carry prominent notices stating that you changed the files and the date of any change.
- b) You must cause any work that you distribute or publish, that in whole or in part contains or is derived from the Program or any part thereof, to be licensed as a whole at no charge to all third parties under the terms of this License.
- c) If the modified program normally reads commands interactively when run, you must cause it, when started running for such interactive use in the most ordinary way, to print or display an announcement including an appropriate copyright notice and a notice that there is no warranty (or else, saying that you provide a warranty) and that users may redistribute the program under these conditions, and telling the user how to view a copy of this License. (Exception: if the Program itself is interactive but does not normally print such an announcement, your work based on the Program is not required to print an announcement.)

These requirements apply to the modified work as a whole. If identifiable sections of that work are not derived from the Program, and can be reasonably considered independent and separate works in themselves, then this License, and its terms, do not apply to those sections when you distribute them as separate works. But when you distribute the same sections as part of a whole which is a work based on the Program, the distribution of the whole must be on the terms of this License, whose permissions for other licensees extend to the entire whole, and thus to each and every part regardless of who wrote it.

Thus, it is not the intent of this section to claim rights or contest your rights to work written entirely by you; rather, the intent is to exercise the right to control the distribution of derivative or collective works based on the Program.

In addition, mere aggregation of another work not based on the Program with the Program (or with a work based on the Program) on a volume of a storage or distribution medium does not bring the other work under the scope of this License.

3. You may copy and distribute the Program (or a work based on it, under Section 2) in object code or executable form under the terms of Sections 1 and 2 above provided that you also do one of the following:

- a) Accompany it with the complete corresponding machine-readable source code, which must be distributed under the terms of Sections 1 and 2 above on a medium customarily used for software interchange; or,
- b) Accompany it with a written offer, valid for at least three years, to give any third party, for a charge no more than your cost of physically performing source distribution, a complete machine-readable copy of the corresponding source code, to be distributed under the terms of Sections 1 and 2 above on a medium customarily used for software interchange; or,
- c) Accompany it with the information you received as to the offer to distribute corresponding source code. (This alternative is allowed only for noncommercial distribution and only if you received the program in object code or executable form with such an offer, in accord with Subsection b above.)

The source code for a work means the preferred form of the work for making modifications to it. For an executable work, complete source code means all the source code for all modules it contains, plus any associated interface definition files, plus the scripts used to control compilation and installation of the executable. However, as a special exception, the source code distributed need not include anything that is normally distributed (in either source or binary form) with the major components (compiler, kernel, and so on) of the operating system on which the executable runs, unless that component itself accompanies the executable.

If distribution of executable or object code is made by offering access to copy from a designated place, then offering equivalent access to copy the source code from the same place counts as distribution of the source code, even though third parties are not compelled to copy the source along with the object code.

4. You may not copy, modify, sublicense, or distribute the Program except as expressly provided under this License. Any attempt otherwise to copy, modify, sublicense or distribute the Program is void, and will automatically terminate your rights under this License. However, parties who have received copies, or rights, from you under this License will not have their licenses terminated so long as such parties remain in full compliance.

5. You are not required to accept this License, since you have not signed it. However, nothing else grants you permission to modify or distribute the Program or its derivative works. These actions are prohibited by law if you do not accept this License. Therefore, by modifying or distributing the Program (or any work based on the Program), you indicate your acceptance of this License to do so, and all its terms and conditions for copying, distributing or modifying the Program or works based on it.

6. Each time you redistribute the Program (or any work based on the Program), the recipient automatically receives a license from the original licensor to copy, distribute or modify the Program subject to these terms and conditions. You may not impose any further restrictions on the recipients' exercise of the rights granted herein. You are not responsible for enforcing compliance by third parties to this License.

7. If, as a consequence of a court judgment or allegation of patent infringement or for any other reason (not limited to patent issues), conditions are imposed on you (whether by court order, agreement or otherwise) that contradict the conditions of this License, they do not excuse you from the conditions of this License. If you cannot distribute so as to satisfy simultaneously your obligations under this License and any other pertinent obligations, then as a consequence you may not distribute the Program at all. For example, if a patent license would not permit royalty-free redistribution of the Program by all those who receive copies directly or indirectly through you, then the only way you could satisfy both it and this License would be to refrain entirely from distribution of the Program.

If any portion of this section is held invalid or unenforceable under any particular circumstance, the balance of the section is intended to apply and the section as a whole is intended to apply in other circumstances.

It is not the purpose of this section to induce you to infringe any patents or other property right claims or to contest validity of any such claims; this section has the sole purpose of protecting the integrity of the free software distribution system, which is implemented by public license practices. Many people have made generous contributions to the wide range of software distributed through that system in reliance on consistent application of that system; it is up to the author/donor to decide if he or she is willing to distribute software through any other system and a licensee cannot impose that choice.

This section is intended to make thoroughly clear what is believed to be a consequence of the rest of this License.

8. If the distribution and/or use of the Program is restricted in certain countries either by patents or by copyrighted interfaces, the original copyright holder who places the Program under this License may add an explicit geographical distribution limitation excluding those countries, so that distribution is permitted only in or among countries not thus excluded. In such case, this License incorporates the limitation as if written in the body of this License.

9. The Free Software Foundation may publish revised and/or new versions of the General Public License from time to time. Such new versions will be similar in spirit to the present version, but may differ in detail to address new problems or concerns.

Each version is given a distinguishing version number. If the Program specifies a version number of this License which applies to it and "any later version", you have the option of following the terms and conditions either of that version or of any later version published by the Free Software Foundation. If the Program does not specify a version number of this License, you may choose any version ever published by the Free Software Foundation.

10. If you wish to incorporate parts of the Program into other free programs whose distribution conditions are different, write to the author to ask for permission. For software which is copyrighted by the Free Software Foundation, write to the Free Software Foundation; we sometimes make exceptions for this. Our decision will be guided by the two goals of preserving the free status of all derivatives of our free software and of promoting the sharing and reuse of software generally.

NO WARRANTY

11. BECAUSE THE PROGRAM IS LICENSED FREE OF CHARGE, THERE IS NO WARRANTY FOR THE PROGRAM, TO THE EXTENT PERMITTED BY APPLICABLE LAW. EXCEPT WHEN OTHERWISE STATED IN WRITING THE COPYRIGHT HOLDERS AND/OR OTHER PARTIES PROVIDE THE PROGRAM "AS IS" WITHOUT WARRANTY OF ANY KIND, EITHER EXPRESSED OR IMPLIED, INCLUDING, BUT NOT LIMITED TO, THE IMPLIED WARRANTIES OF MERCHANTABILITY AND FITNESS FOR A PARTICULAR PURPOSE. THE ENTIRE RISK AS TO THE QUALITY AND PERFORMANCE OF THE PROGRAM IS WITH YOU. SHOULD THE PROGRAM PROVE DEFECTIVE, YOU ASSUME THE COST OF ALL NECESSARY SERVICING, REPAIR OR CORRECTION.

12. IN NO EVENT UNLESS REQUIRED BY APPLICABLE LAW OR AGREED TO IN WRITING WILL ANY COPYRIGHT HOLDER, OR ANY OTHER PARTY WHO MAY MODIFY AND/OR REDISTRIBUTE THE PROGRAM AS PERMITTED ABOVE, BE LIABLE TO YOU FOR DAMAGES, INCLUDING ANY GENERAL, SPECIAL, INCIDENTAL OR CONSEQUENTIAL DAMAGES ARISING OUT OF THE USE OR INABILITY TO USE THE PROGRAM (INCLUDING BUT NOT LIMITED TO LOSS OF DATA OR DATA BEING RENDERED INACCURATE OR LOSSES SUSTAINED BY YOU OR THIRD PARTIES OR A FAILURE OF THE PROGRAM TO OPERATE WITH ANY OTHER PROGRAMS), EVEN IF SUCH HOLDER OR OTHER PARTY HAS BEEN ADVISED OF THE POSSIBILITY OF SUCH DAMAGES.