

LOGITECH G PRO X 60

LIGHTSPEED Gaming Keyboard
Clavier gaming LIGHTSPEED

SETUP GUIDE | GUIDE D'INSTALLATION



logitech 

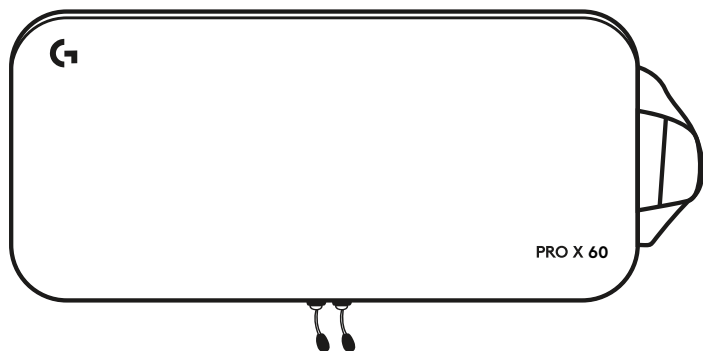
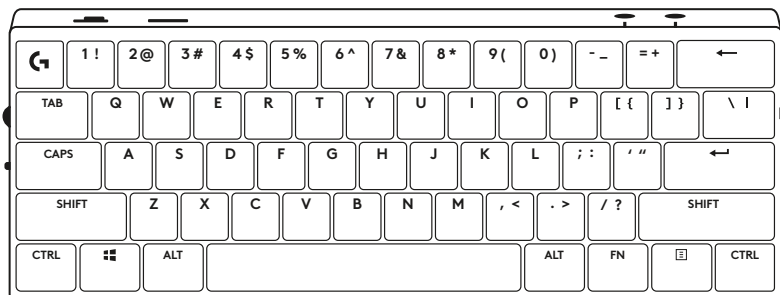

ENGLISH	3	108	فارسی
DEUTSCH	10	ČESKÁ VERZE.	115
FRANÇAIS.	17	SLOVENČINA	122
ITALIANO	24	УКРАЇНСЬКА	129
ESPAÑOL	31	EESTI.	136
PORTUGUÊS	38	LATVISKI.	143
NEDERLANDS	45	LIETUVIŲ	150
SVENSKA	52	БЪЛГАРСКИ	157
DANSK.	59	HRVATSKI	164
NORSK	66	SRPSKI.	171
SUOMI.	73	SLOVENŠČINA	178
ΕΛΛΗΝΙΚΑ	80	ROMÂNĂ	185
ПО-РУССКИ.	87	TÜRKÇE	192
PO POLSKU	94	199	العربية
MAGYAR.	101		

PRODUCT OVERVIEW

Top View

- 1 Power switch
- 2 Type-C port
- 3 *BLUETOOTH*[®] button
- 4 LIGHTSPEED button
- 5 Game Mode switch
- 6 Power indicator
- 7 Volume roller
- 8 Caps Lock indicator

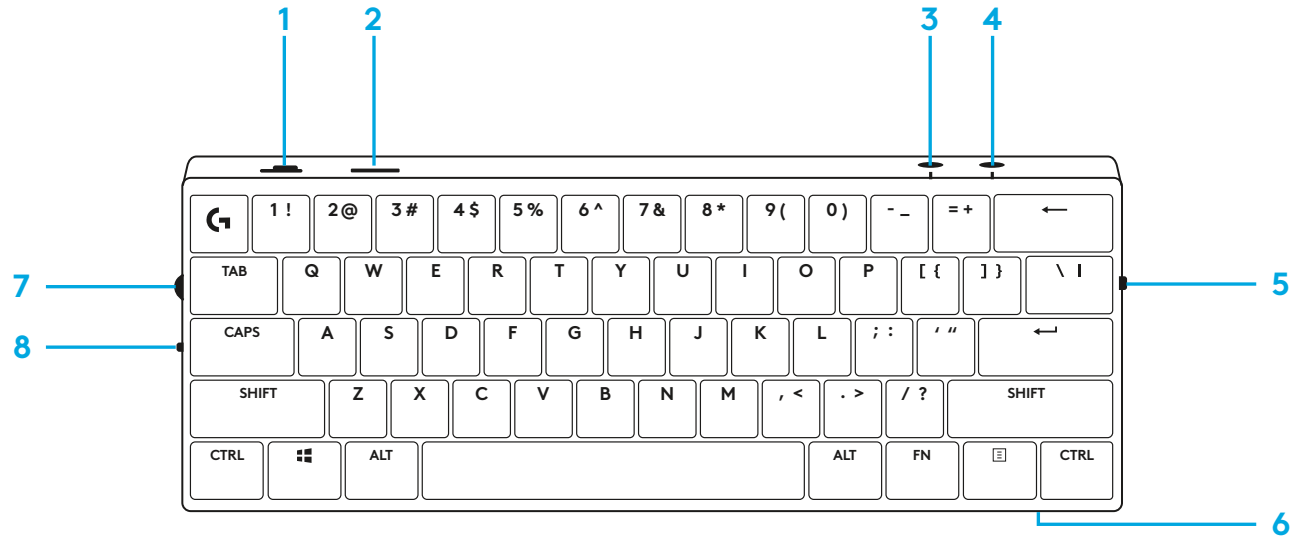

Bottom View

- 1 Dongle storage
- 2 Tilt legs

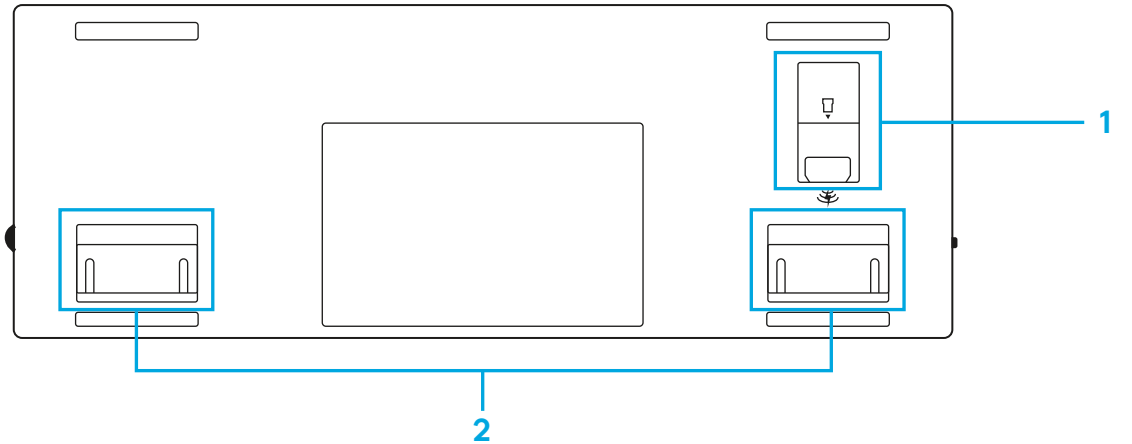

LIGHTSPEED CONNECTION

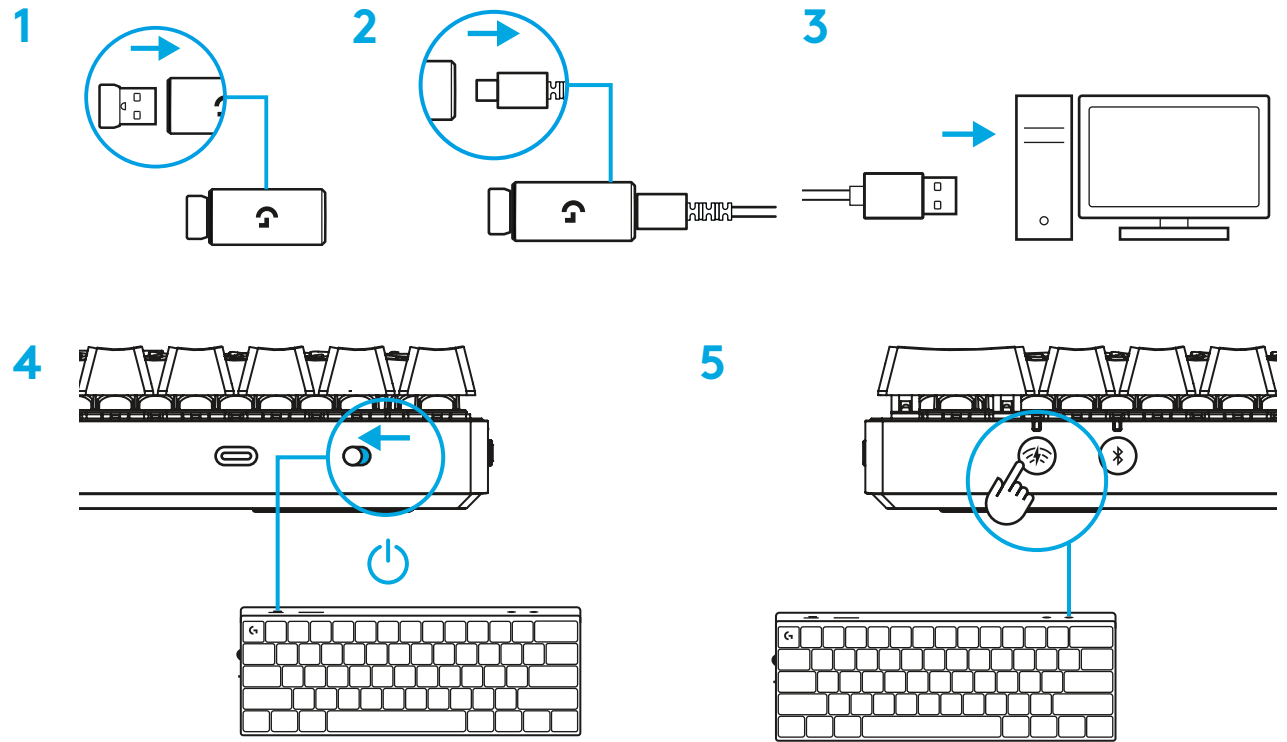

Download and install G HUB software to your PC/MAC for the best gaming experience (G HUB has an onboarding story for features).
Go to www.logitechG.com/ghub

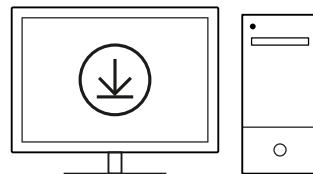

logitechG.com/ghub

BLUETOOTH® CONNECTION

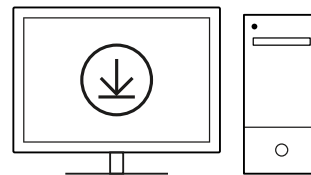
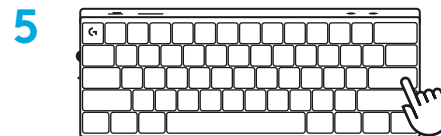
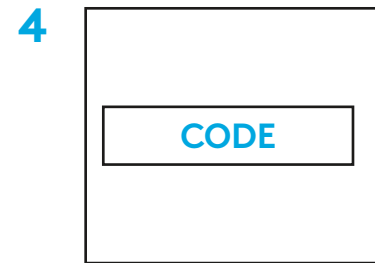
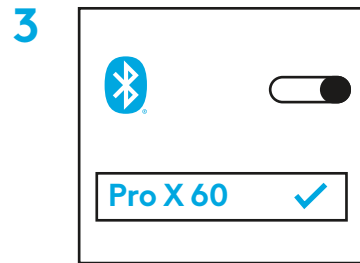
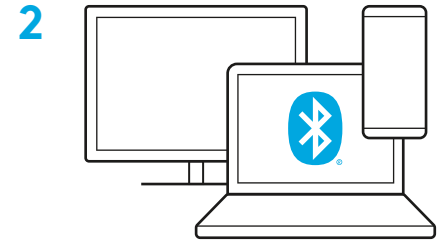
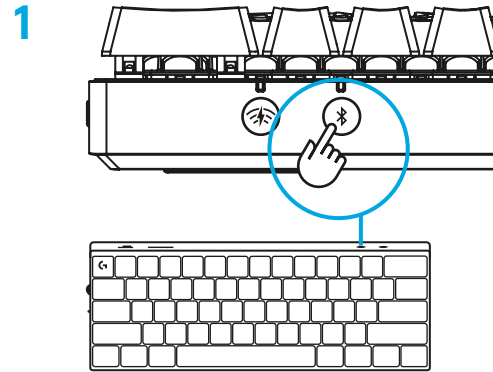

logitechG.com/ghub

Download and install G HUB software to your PC/MAC for the best gaming experience (G HUB has onboarding story for features).
Go to www.logitechG.com/ghub

CHARGING YOUR KEYBOARD

- 1 Insert the *USB-C* cable into the port at the front of the keyboard.
- 2 Connect the cable to your PC.

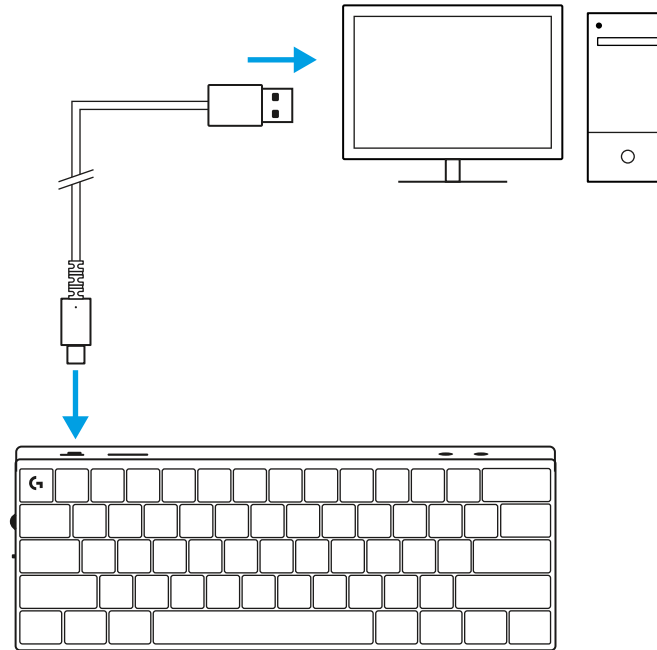

The battery indicator light will pulse green while charging and be solid green when fully charged.

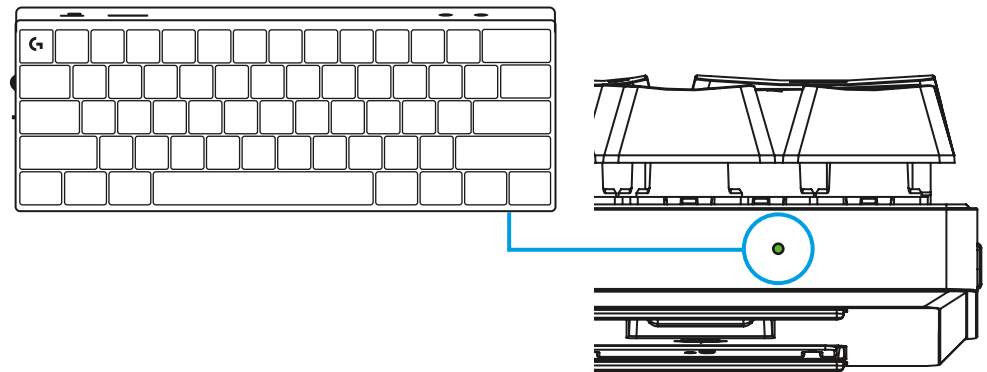

GAME MODE



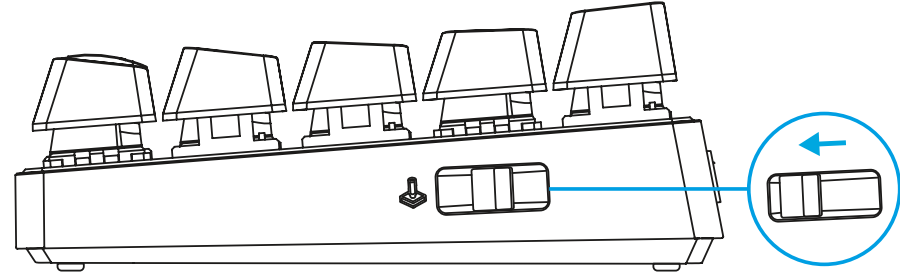

Switch on Game mode will disable Windows key functions to avoid accidental triggering.

You can also disable different keys in Ghub settings.





KEY COMBINATIONS









Media Controls

FN + 	Play/Pause
FN + 	Mute
FN + 	Previous Track
FN + 	Next Track

















ESC Keys

FN + 	`
FN + SHIFT + 	~









Arrow Keys

 + 	Up Arrow
 + 	Down Arrow
 + 	Right Arrow
 + 	Left Arrow







Function Keys

 + 	Screenshot
 + 	Home
 + 	Page up
 + 	Page down
 + 	Scroll Lock
 + 	End
 + 	Insert
 + 	Pause / Break



Lighting Control

 + 	Decrease the keyboard brightness
 + 	Increase the keyboard brightness
 + 	Cycle through the animation effect
 + 	Cycle through animation parameters

Profile Switches

 + 	Activate one of the three onboard memory profiles
 + 	
 + 	

Full Key Customization on/off

 + 	Enable Full Key Customization
	Toggle to switch between Default and Customized layout

PRODUKTÜBERSICHT

Ansicht von oben

- 1 Ein/Aus-Schalter
- 2 Typ-C-Anschluss
- 3 *BLUETOOTH*[®]-Taste
- 4 LIGHTSPEED Taste
- 5 Spielmodusschalter
- 6 Betriebs-LED
- 7 Lautstärkeregler
- 8 Feststellanzeige

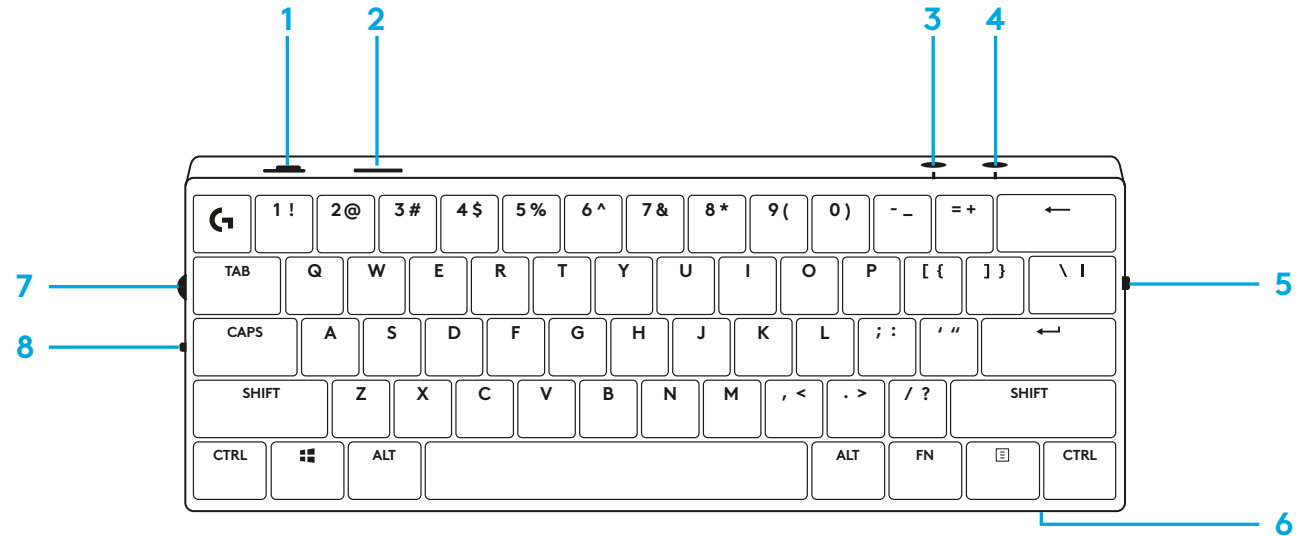

Ansicht von unten:

- 1 Fach zur Aufbewahrung des Dongles
- 2 Ausklappbare FüÙe

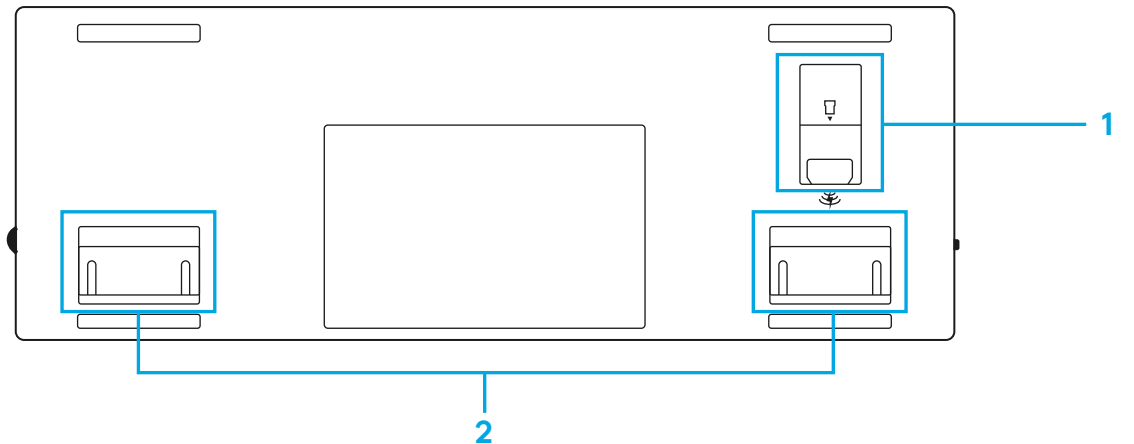

LIGHTSPEED VERBINDUNG

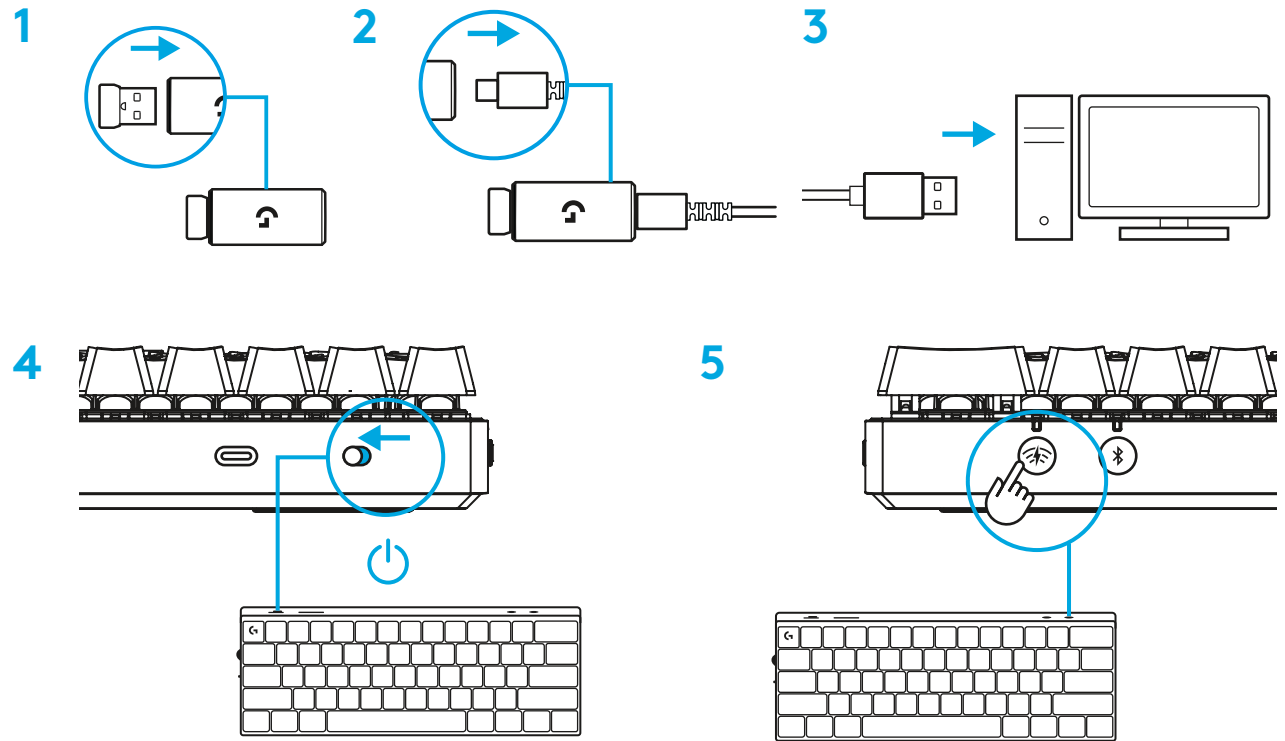

Lade die G HUB Software auf den PC/ MAC herunter und installiere sie, um das optimale Gaming-Erlebnis zu gewährleisten (G HUB bietet eine Einführungs-Story zu den einzelnen Funktionen).
Gehe zu www.logitechG.com/ghub

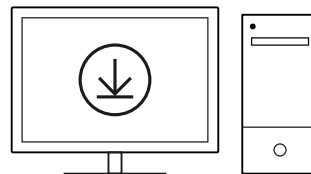

logitechG.com/ghub

BLUETOOTH®-VERBINDUNG

1

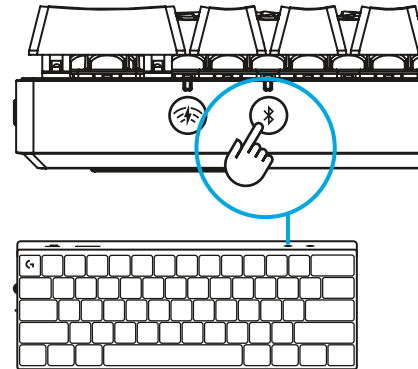

2

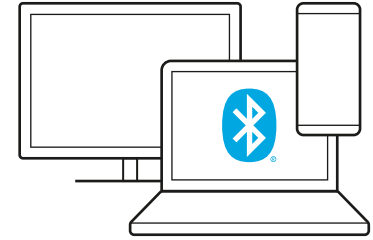

3

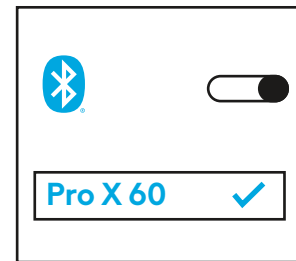

4

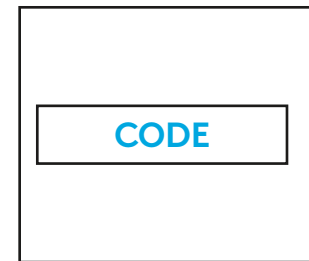

5

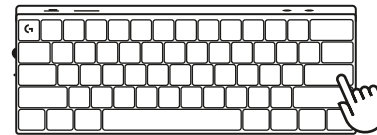

Lade die G HUB Software auf den PC/MAC herunter und installiere sie, um das optimale Gaming-Erlebnis zu gewährleisten (G HUB bietet eine Einführungs-Story zu den einzelnen Funktionen).
Gehe zu www.logitechG.com/ghub

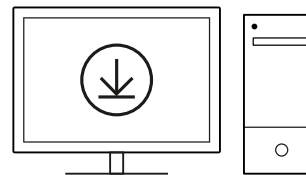

logitechG.com/ghub

AUFLADEN DER TASTATUR

- 1 Schließe das *USB-C*-Kabel an den Anschluss vorn an der Tastatur an.

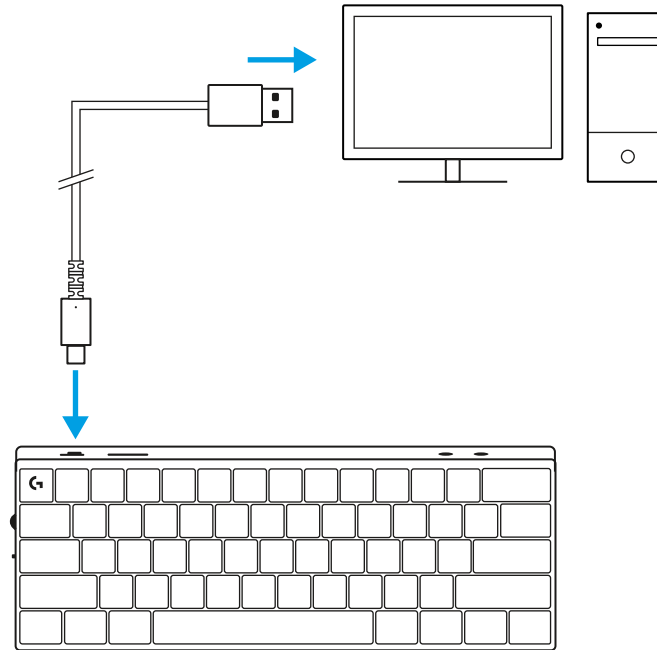

- 2 Schließe das Kabel an den PC an.
Die Akkustands-LED pulsiert während des Aufladens grün und leuchtet bei voller Aufladung konstant grün.

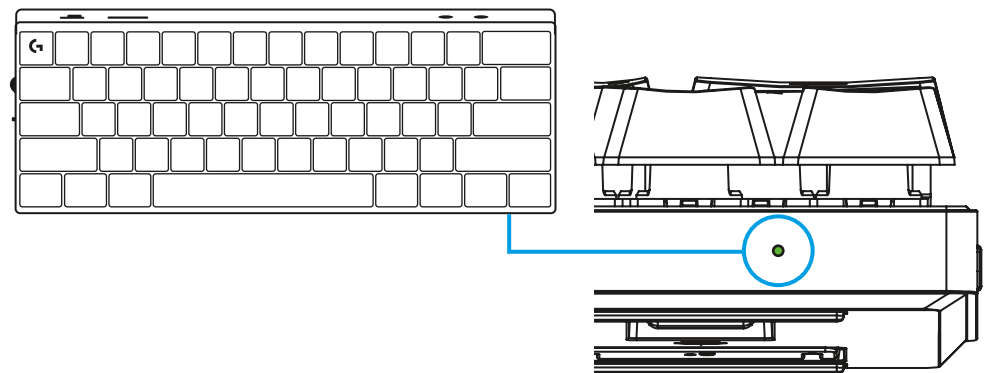

SPIELMODUS

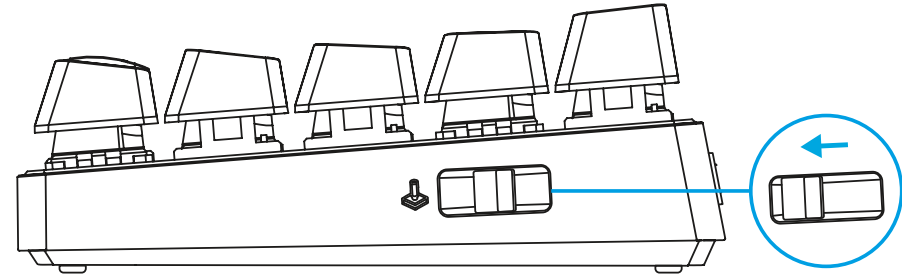

Durch Aktivieren des Spielmodus werden die Windows-Tastenfunktionen deaktiviert, um ein versehentliches Auslösen zu vermeiden.

Du kannst auch unterschiedliche Tasten in den G Hub Einstellungen deaktivieren.

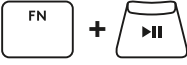

TASTENKOMBINATIONEN

Multimedia-Bedienelemente

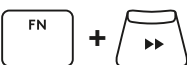
	Wiedergabe/Pause
	Ton aus
	Vorheriger Titel
	Nächster Titel



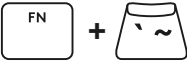
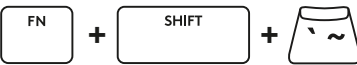

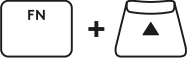
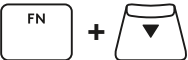
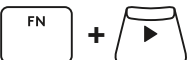
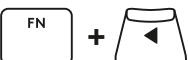

Esc-Tasten

	`
	~

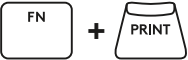
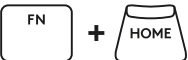
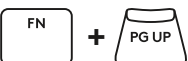
Pfeiltasten

	Pfeil nach oben
	Pfeil nach unten
	Rechtspfeil
	Linkspfeil

Funktionstasten

	Screenshot
	Home
	Bild auf
	Bild ab
	Rollen-Taste
	Ende
	Einfügen
	Pause

Beleuchtungssteuerung

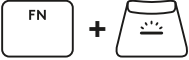
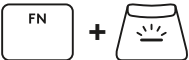
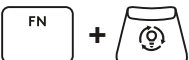
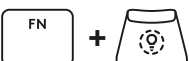
	Tastaturbeleuchtung dunkler
	Tastaturbeleuchtung heller
	Animationseffekt durchlaufen
	Animationsparameter durchlaufen

Profilschalter

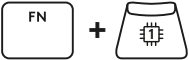
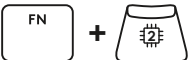
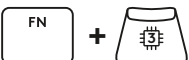
  	Aktivierung eines der drei integrierten Speicherprofile
-------------------------------------------------------------------------------------------------------------------------------------------------------------------------------------------------------------------------------------------------------------------	---------------------------------------------------------

Volle Tastenanpassung ein/aus

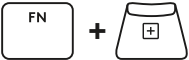
	Volle Tastenanpassung ein
	Umschalten zum Wechseln zwischen Standardlayout und angepasstem Layout

PRÉSENTATION DU PRODUIT

Vue de dessus

- 1 Commutateur d'alimentation
- 2 Port USB type C
- 3 Bouton *BLUETOOTH*[®]
- 4 Bouton *LIGHTSPEED*
- 5 Commutateur Mode Jeu
- 6 Témoin lumineux d'alimentation
- 7 Molette de volume
- 8 Indicateur de verrouillage des majuscules



Vue de dessous

- 1 Compartiment de stockage du dongle
- 2 Pieds d'inclinaison

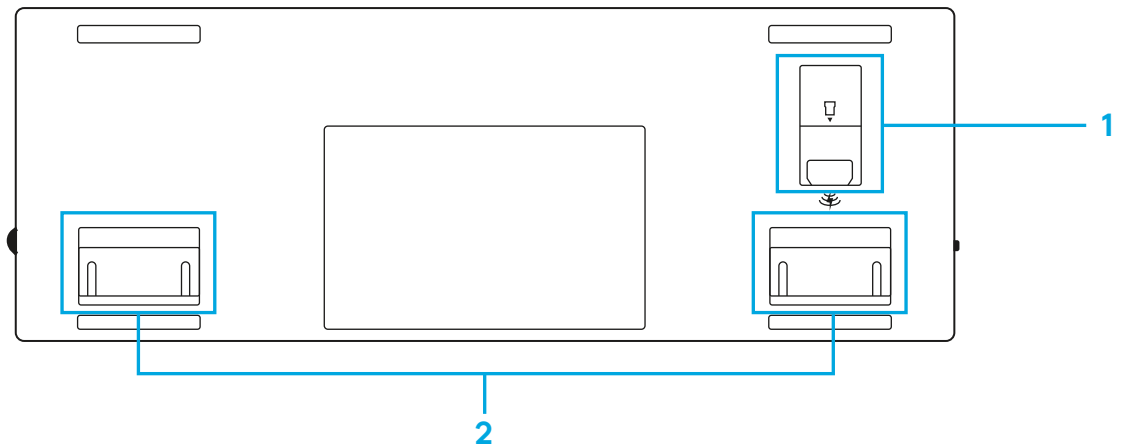

CONNEXION LIGHTSPEED

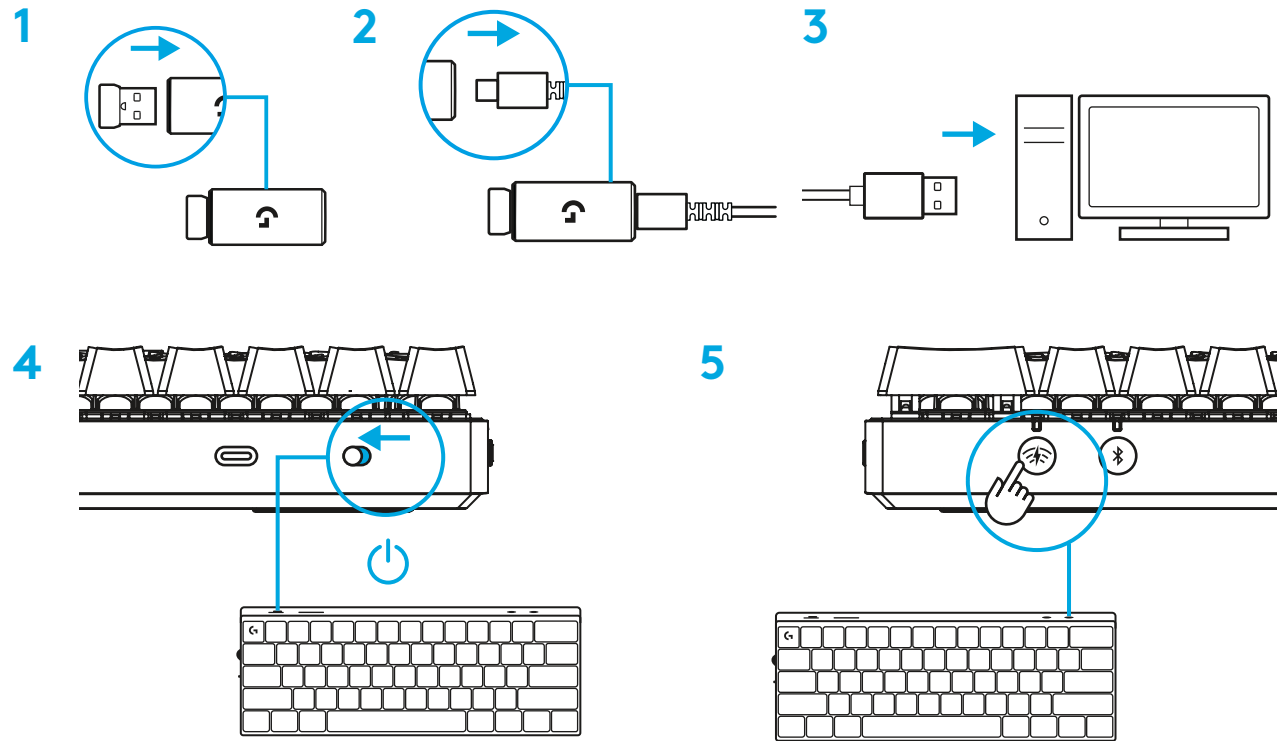

Téléchargez et installez le logiciel G HUB sur votre PC/MAC pour une expérience de jeu optimale (G HUB propose un parcours d'intégration pour les fonctionnalités).
Rendez-vous sur <https://www.logitechG.com/ghub>

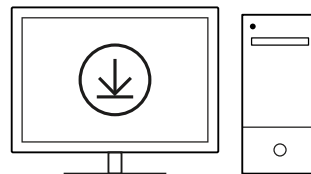

[logitechG.com/ghub](https://www.logitechG.com/ghub)

CONNEXION BLUETOOTH®

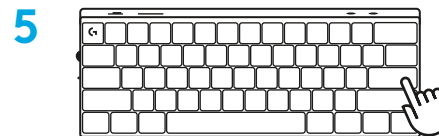
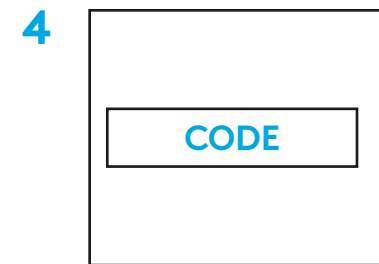
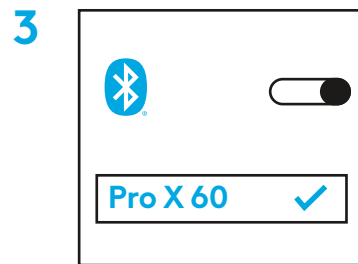
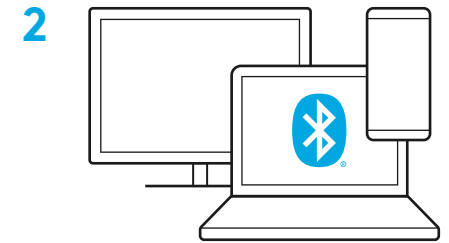
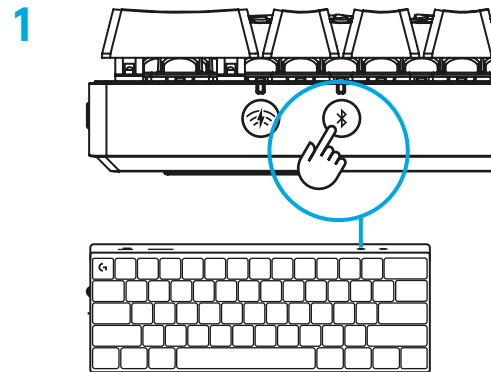

Téléchargez et installez le logiciel G HUB sur votre PC/
MAC pour une expérience de jeu optimale (G HUB propose
un parcours d'intégration pour les fonctionnalités).
Rendez-vous sur <https://www.logitechG.com/ghub>

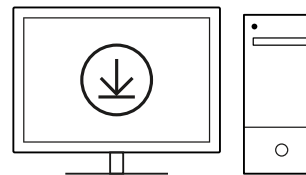

[logitechG.com/ghub](https://www.logitechG.com/ghub)

CHARGE DE VOTRE CLAVIER

- 1 Insérez le câble *USB-C* dans le port situé à l'avant du clavier.

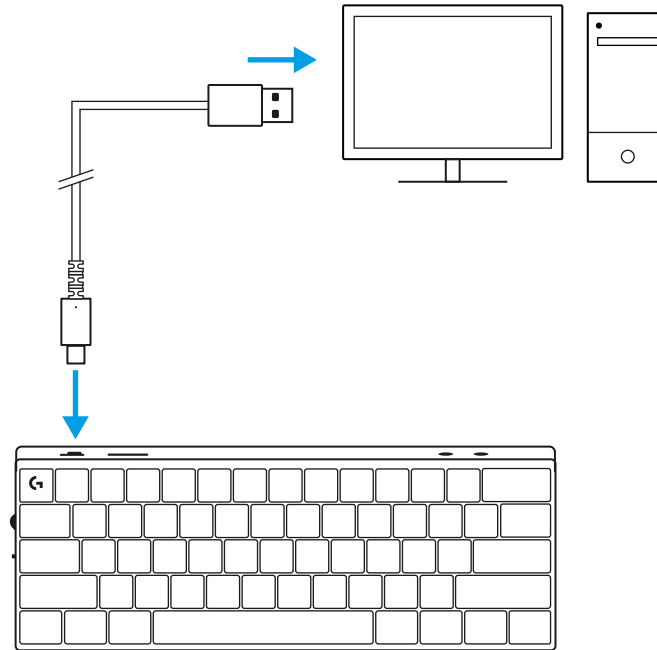

- 2 Connectez le câble à votre PC.
Le témoin lumineux de la batterie clignotera en vert pendant la charge et restera allumé en vert en continu une fois entièrement chargé.

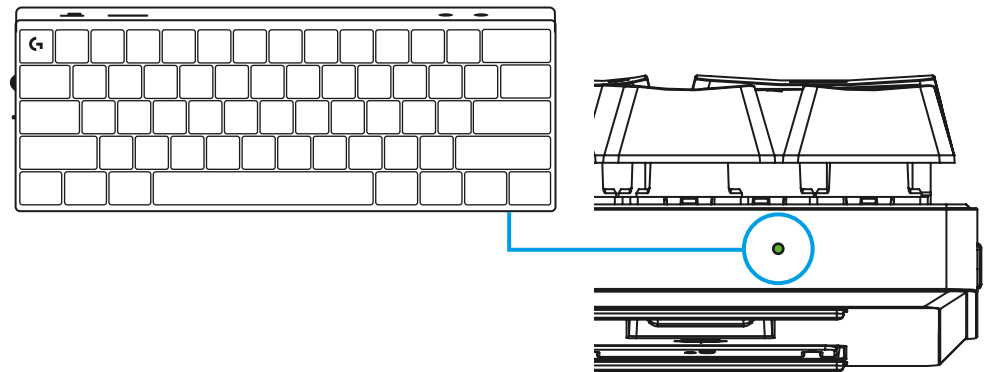

MODE JEU





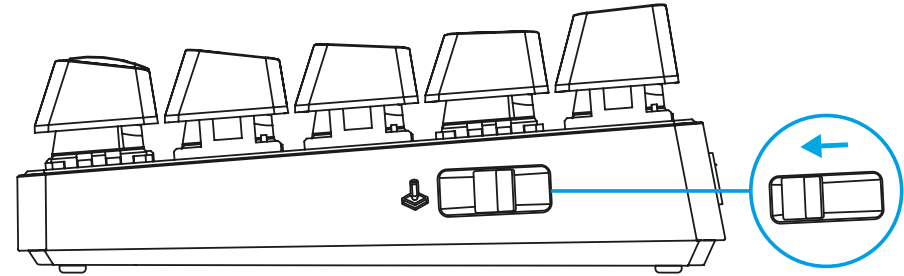



L'activation du mode Jeu désactivera les fonctions des touches Windows afin d'éviter un déclenchement accidentel.

Vous pouvez également désactiver d'autres touches depuis les paramètres G Hub.







COMBINAISONS DE TOUCHES

Commandes multimédia

 + 	Lecture/Pause
 + 	Couper le son
 + 	Piste précédente
 + 	Piste suivante

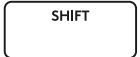

Touches Échap

 + 	`
 +  + 	~

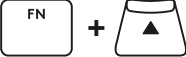
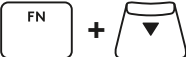
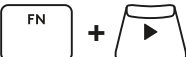
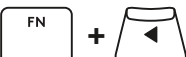
Touches fléchées

	Flèche vers le haut
	Flèche vers le bas
	Flèche droite
	Flèche gauche

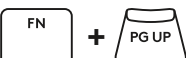
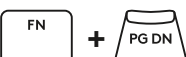
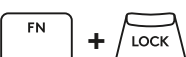
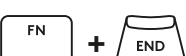
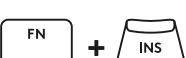
Touches de fonction

	Capture d'écran
	Accueil
	Page précédente
	Page suivante
	Arrêt défilement
	Fin
	Insérer
	Pause

Contrôle de l'éclairage

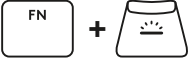
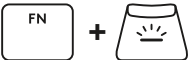
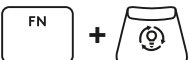
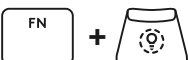
	Diminution de la luminosité du clavier
	Augmentation de la luminosité du clavier
	Parcourir les effets d'animation
	Parcourir les paramètres d'animation

Commutateurs de profil

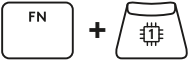
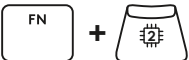
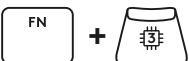
  	Activation d'un des trois profils en mémoire
-------------------------------------------------------------------------------------------------------------------------------------------------------------------------------------------------------------------------------------------------------------------	----------------------------------------------

Activer/désactiver la personnalisation complète des touches

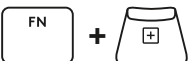
	Activation de la personnalisation complète des touches
	Basculement entre la disposition par défaut et la disposition personnalisée

PANORAMICA DEL PRODOTTO

Vista dall'alto

- 1 Pulsante di accensione
- 2 Porta di tipo C
- 3 Pulsante *BLUETOOTH*[®]
- 4 Pulsante *LIGHTSPEED*
- 5 Interruttore modalità di gioco
- 6 Indicatore alimentazione
- 7 Rotellina di regolazione del volume
- 8 Indicatore Bloc Maiusc

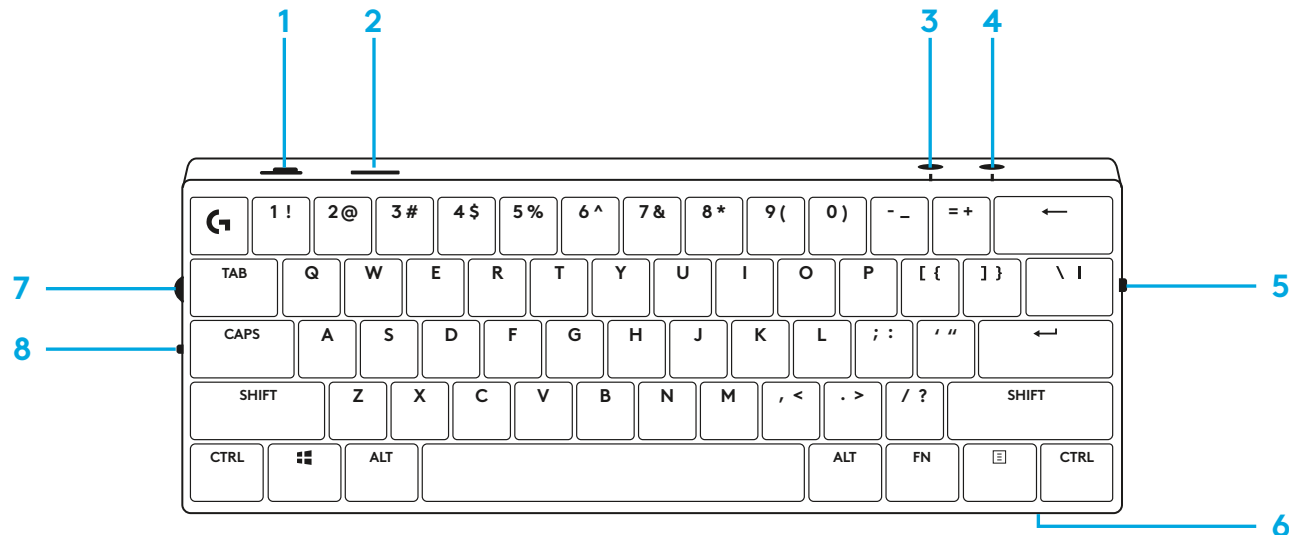

Vista dal basso

- 1 Alloggiamento dongle
- 2 Piedini inclinabili

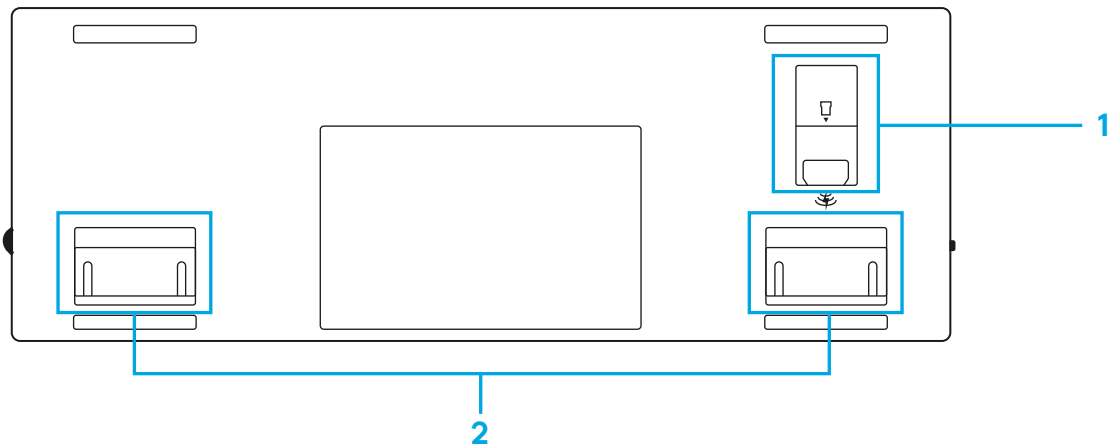

CONNESSIONE LIGHTSPEED

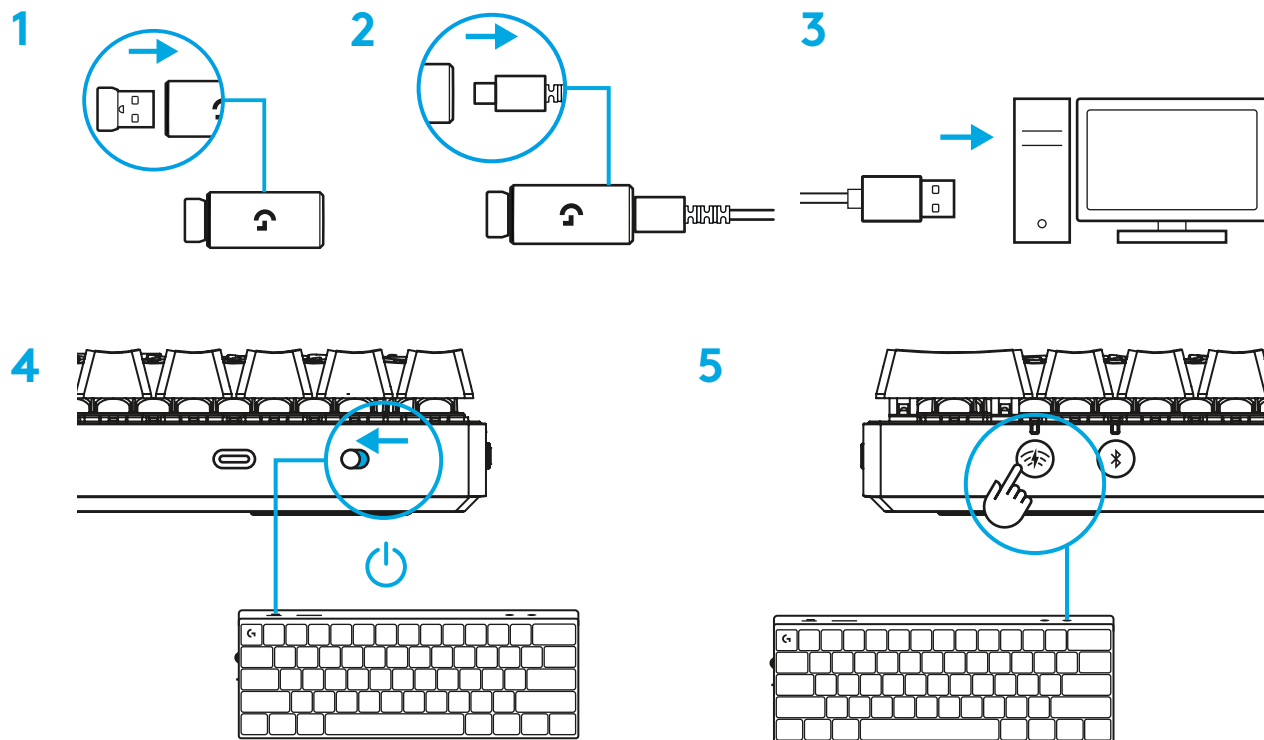

Scaricare e installare il software G HUB su PC/MAC per la migliore esperienza di gaming (G HUB integra una storia introduttiva per le funzionalità).
Accedere a www.logitechG.com/ghub

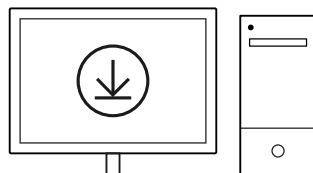

logitechG.com/ghub

CONNESSIONE BLUETOOTH®

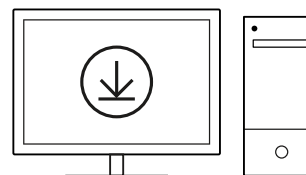
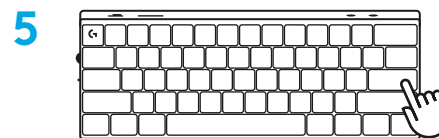
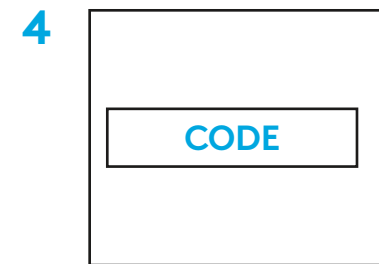
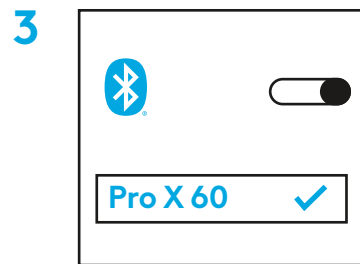
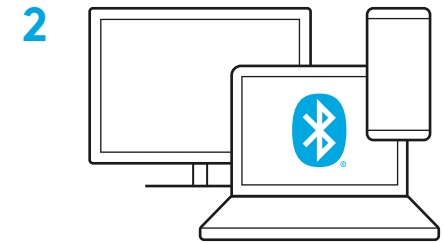
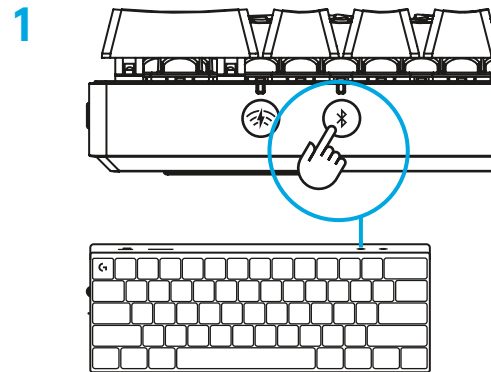

logitechG.com/ghub

Scaricare e installare il software G HUB su PC/MAC per la migliore esperienza di gaming (G HUB integra una storia introduttiva per le funzionalità).
Accedere a www.logitechG.com/ghub

RICARICA DELLA TASTIERA

- 1 Inserire il cavo *USB-C* nella porta nella parte anteriore della tastiera.

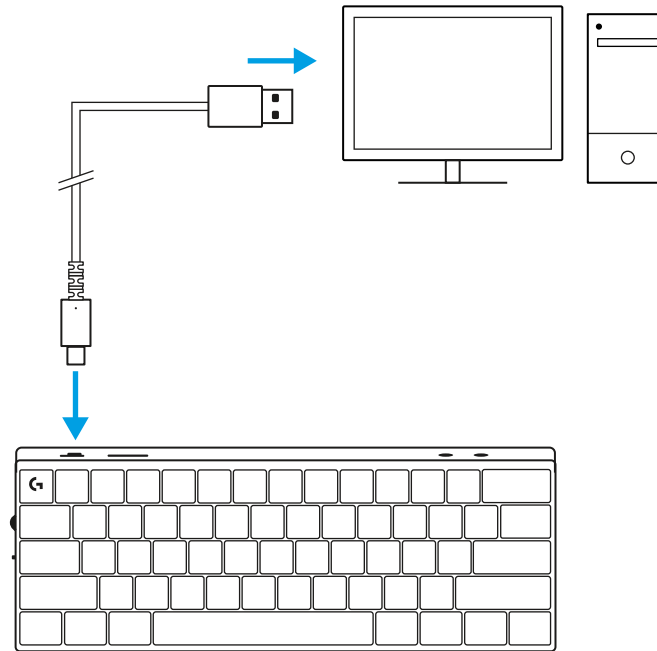

- 2 Collegare il cavo al PC.
L'indicatore luminoso del livello di carica della batteria lampeggerà in verde durante la ricarica e diventerà verde fisso quando la batteria sarà completamente carica.

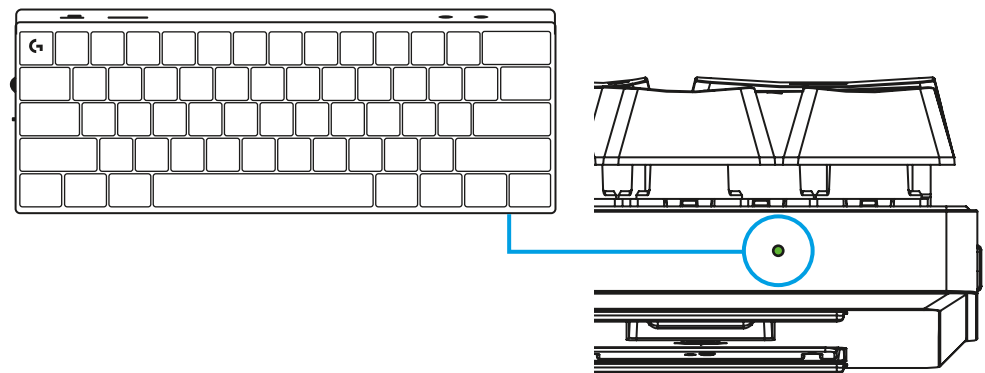

MODALITÀ GIOCO

Il passaggio alla modalità Gioco disattiva le funzioni dei tasti Windows per evitare di attivarle accidentalmente.

È inoltre possibile disattivare diversi tasti nelle impostazioni di Ghub.

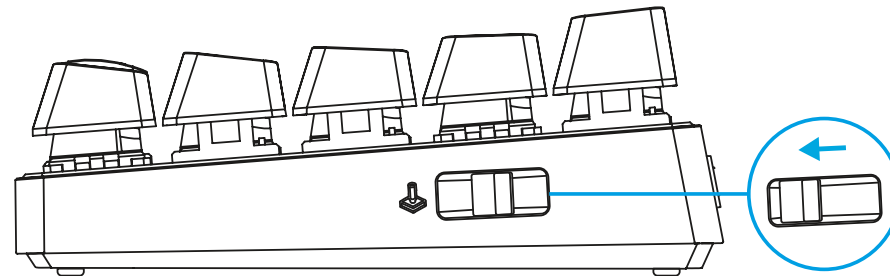

COMBINAZIONI TASTI

Controlli multimediali

	Riproduci/Pausa
	Disattiva audio
	Brano precedente
	Brano successivo

Tasti Esc

	~
	~

Tasti freccia

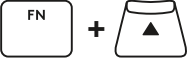
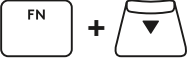
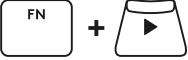
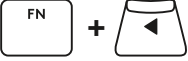
	Freccia su
	Freccia giù
	Freccia destra
	Freccia sinistra

Tasti funzione

	Istantanea schermo
	Pagina iniziale
	Pagina su
	Pagina giù
	Bloc Scorr
	Fine
	Inserisci
	Pausa/Interr

Controlli di illuminazione

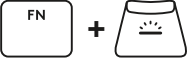
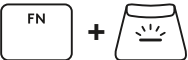
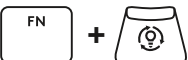
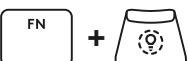
	Riduci luminosità della tastiera
	Aumenta luminosità della tastiera
	Seleziona in sequenza gli effetti animazione
	Seleziona in sequenza i parametri animazione

Interruttori per il cambio profilo

	Attiva uno dei tre profili della memoria interna
	
	

Personalizzazione completa tasti attivata/disattivata

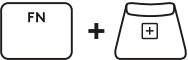
	Attiva personalizzazione completa tasti
	Aziona per alternare tra layout predefinito e personalizzato

DESCRIPCIÓN GENERAL DEL PRODUCTO

Vista superior

- 1 Conmutador de encendido
- 2 Puerto USB-C
- 3 Botón *BLUETOOTH*[®]
- 4 Botón *LIGHTSPEED*
- 5 Conmutador de modo de juego
- 6 Indicador de encendido
- 7 Control giratorio del volumen
- 8 Indicador de bloqueo de mayúsculas

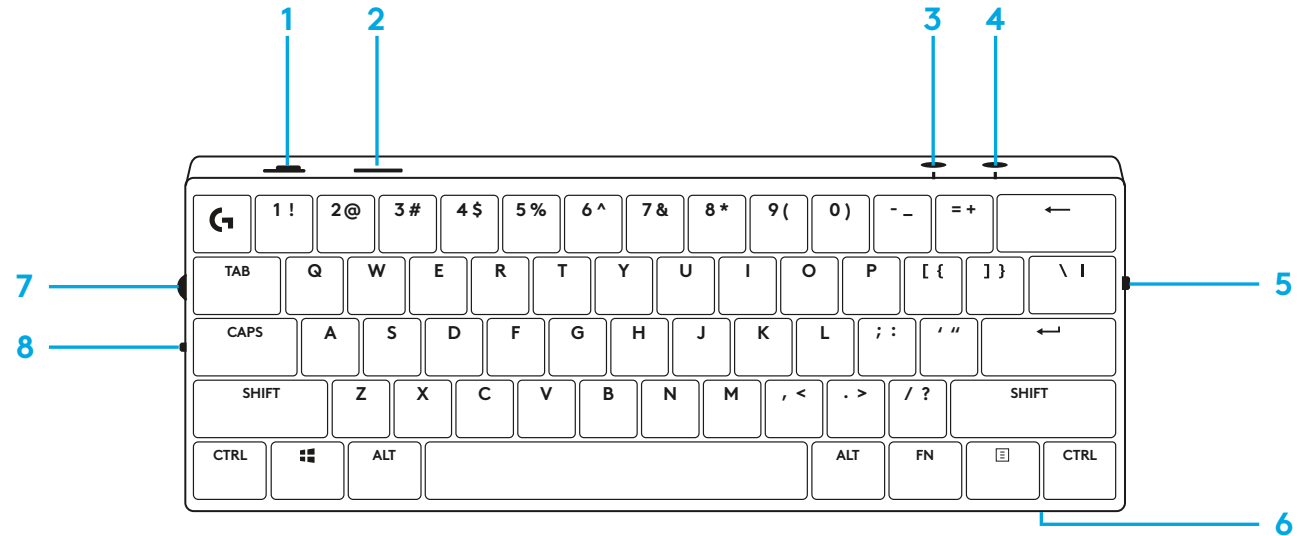

Vista inferior

- 1 Almacenamiento de llave USB
- 2 Patas ajustables

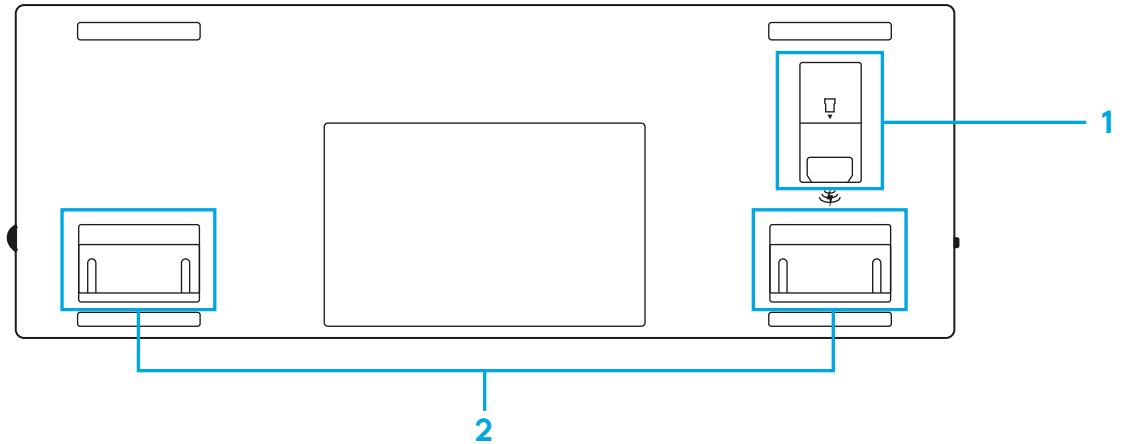

CONEXIÓN LIGHTSPEED

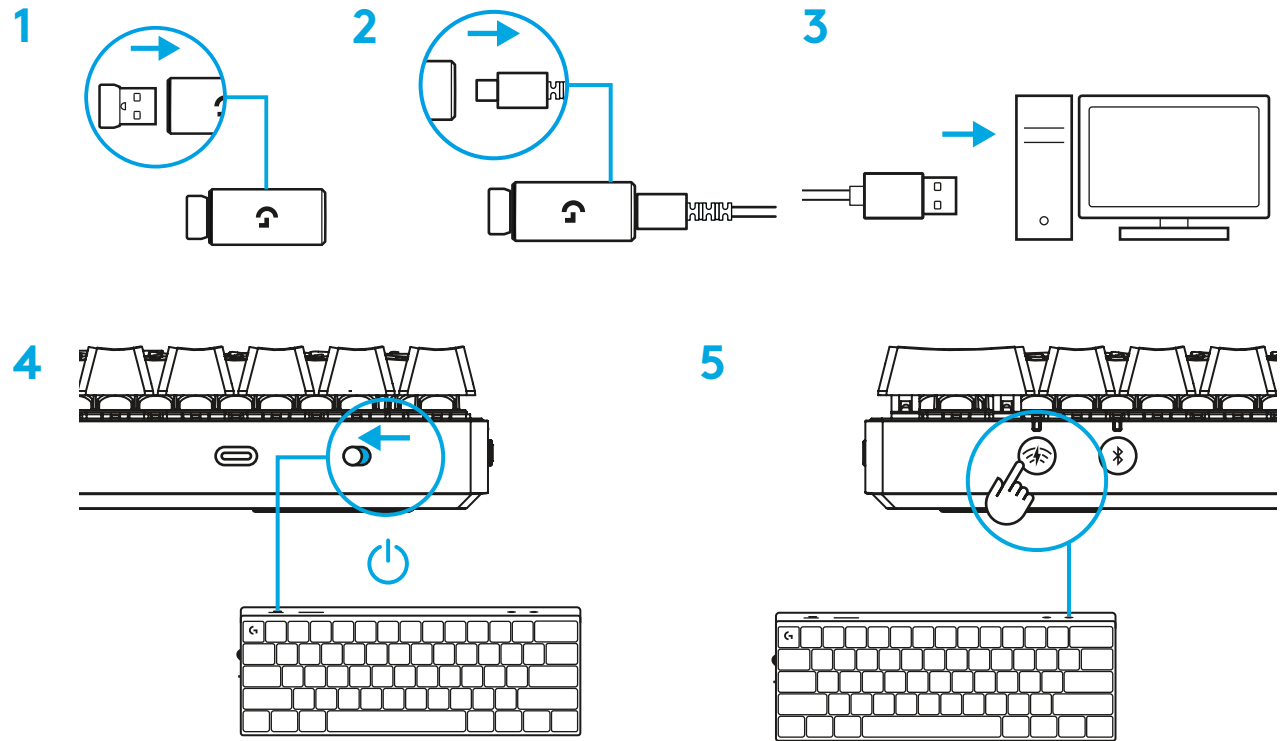

Descarga e instala el software G HUB en tu PC/MAC para la mejor experiencia de gaming (G HUB ofrece integración de funciones).
Ve a www.logitechG.com/g Hub

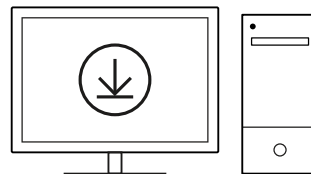

logitechG.com/g Hub

CONEXIÓN BLUETOOTH®

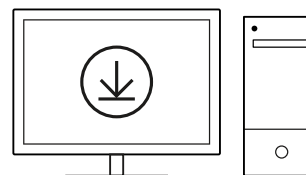
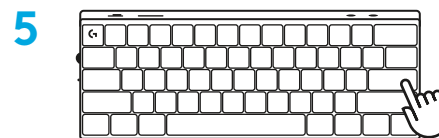
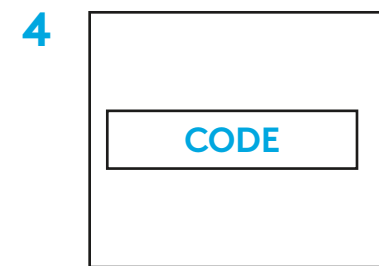
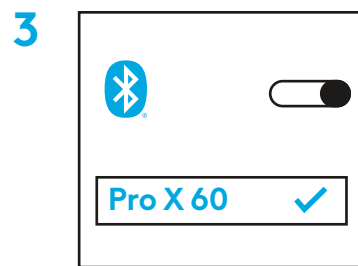
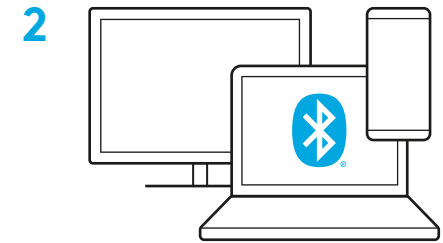
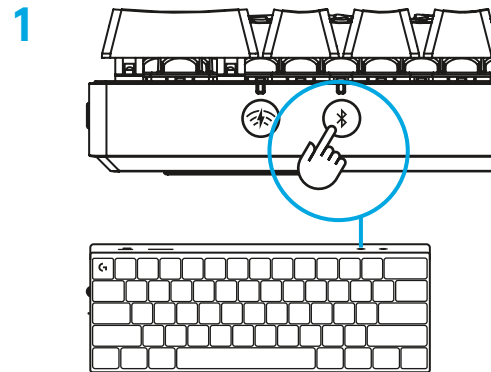

logitechG.com/ghub

Descarga e instala el software G HUB en tu PC/MAC para una experiencia de gaming óptima (G HUB ofrece integración de funciones).

Ve a www.logitechG.com/ghub

CARGA DEL TECLADO

- 1 Inserta el cable *USB-C* en el puerto situado en la parte frontal del teclado.

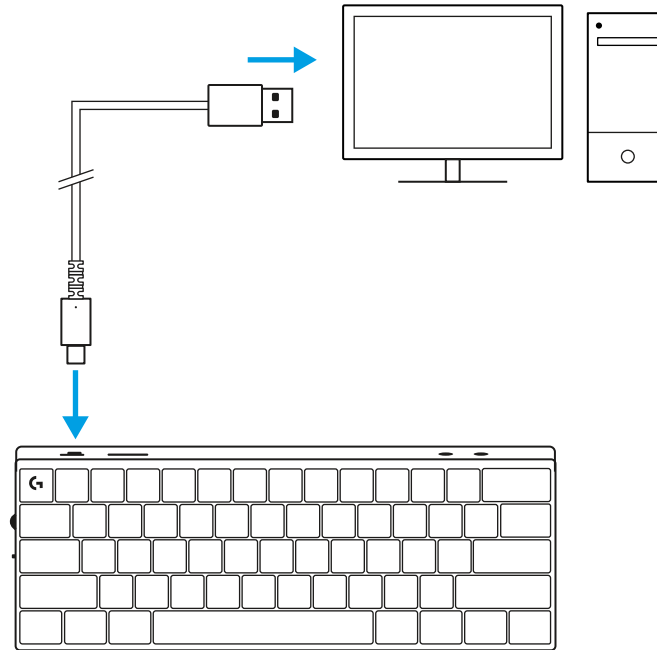

- 2 Conecta el cable al PC.
El indicador luminoso de carga emitirá pulsos verdes durante el proceso de carga y se volverá permanente una vez que la carga se complete.

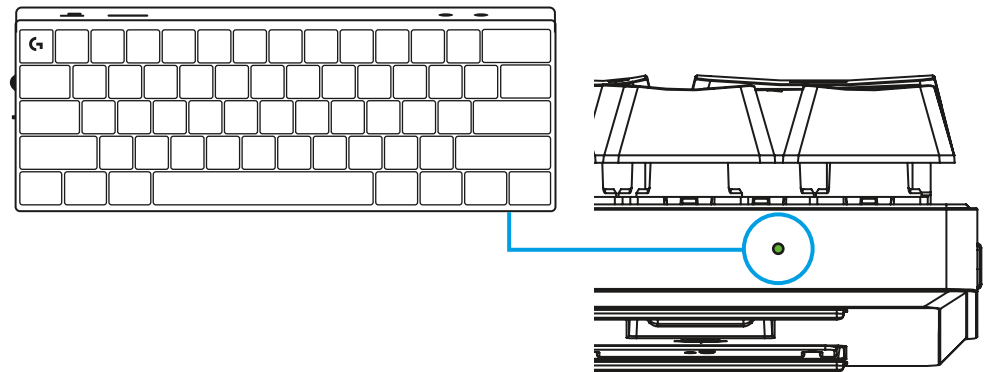

MODO DE JUEGO

Activar el Modo de juego desactivará las funciones de las teclas de Windows para evitar acciones involuntarias.

También puedes desactivar distintas teclas en la configuración de Ghub.

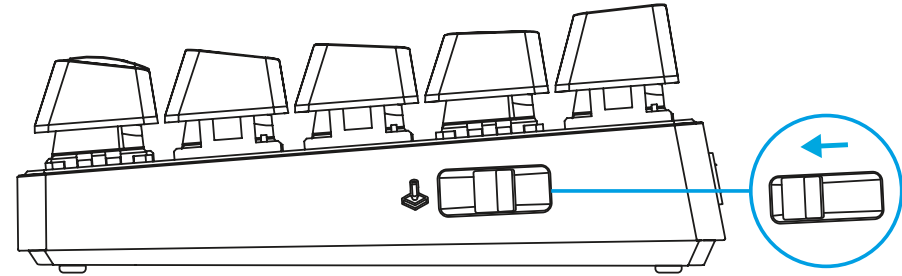

COMBINACIONES DE TECLAS









Controles multimedia

	Reproducir/Pausa
	Silencio
	Pista anterior
	Pista siguiente

Teclas ESC

	`
	~



Teclas de dirección

 + 	Flecha hacia arriba
 + 	Flecha hacia abajo
 + 	Flecha hacia la derecha
 + 	Flecha hacia la izquierda

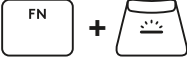
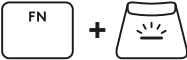

Teclas de función

 + 	Captura de pantalla
 + 	Inicio
 + 	Retroceder página
 + 	Avanzar página
 + 	Bloqueo de desplazamiento
 + 	Fin
 + 	Insertar
 + 	Pausa/Interrupción

Control de iluminación

	Reducir brillo del teclado
	Aumentar brillo del teclado
	Recorrer opciones de efectos de animación
	Recorrer parámetros de animación

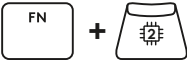
Conmutadores de perfil

	Activar uno de los tres perfiles de memoria interna
	
	

Activar/Desactivar la personalización total de teclas

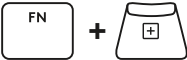
	Activar la personalización total de teclas
	Alternar entre distribución predeterminada y personalizada

DESCRIÇÃO GERAL DO PRODUTO

Vista de cima

- 1 Botão Ligar/desligar
- 2 Porta tipo C
- 3 Botão *BLUETOOTH*[®]
- 4 Botão *LIGHTSPEED*
- 5 Interruptor de Modo de jogo
- 6 Indicador de energia
- 7 Selector de volume
- 8 Indicador de Caps Lock

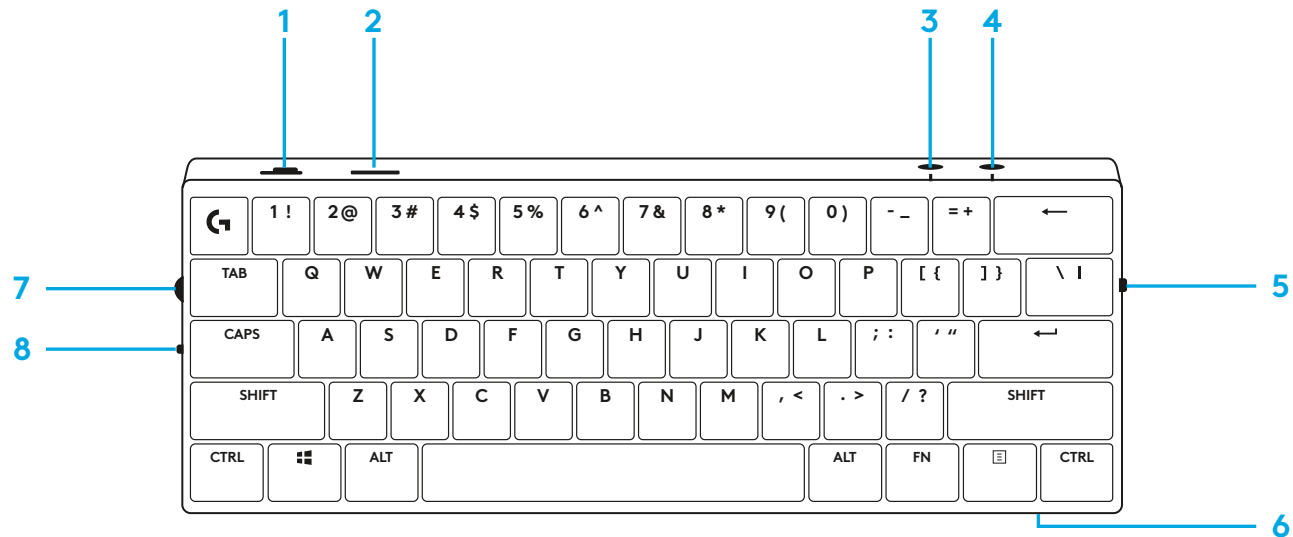

Vista inferior

- 1 Armazenamento do Dongle
- 2 Suportes inclináveis.

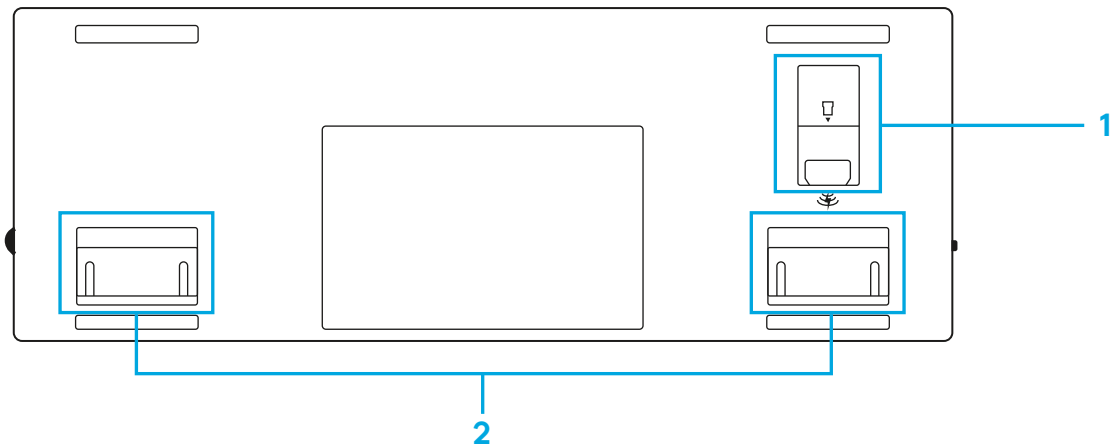

LIGAÇÃO LIGHTSPEED

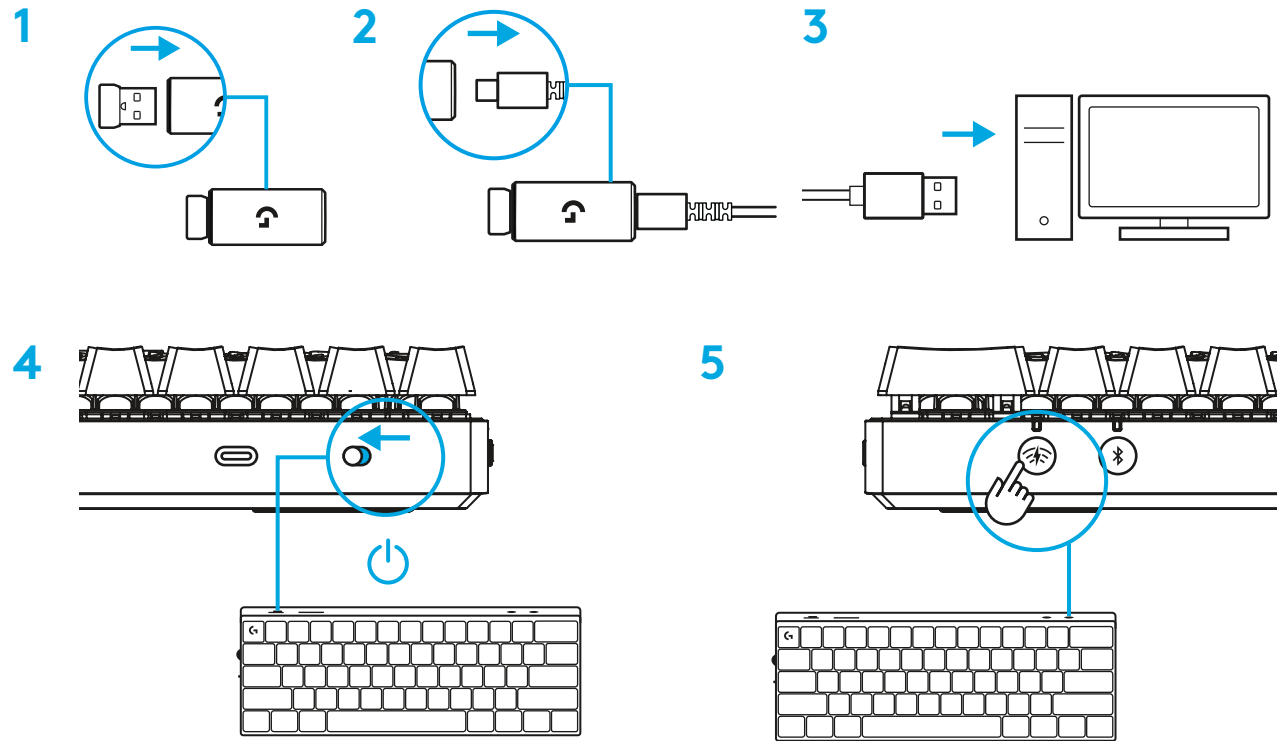

Transfira e instale o software G HUB no seu PC/MAC para obter a melhor experiência de jogo (o G HUB tem uma história de integração para as funcionalidades).
Aceda a www.logitechG.com/ghub

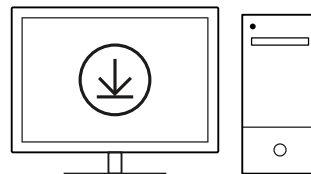

logitechG.com/ghub

LIGAÇÃO BLUETOOTH®

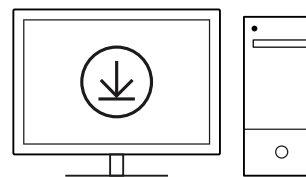
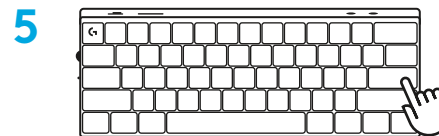
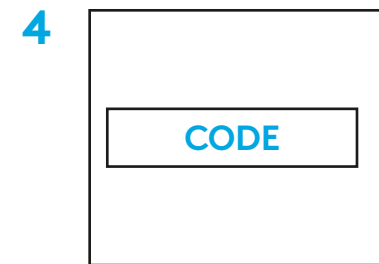
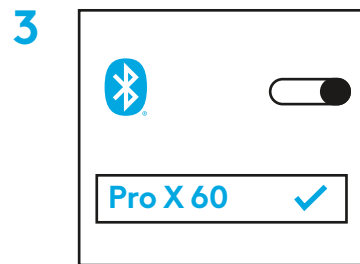
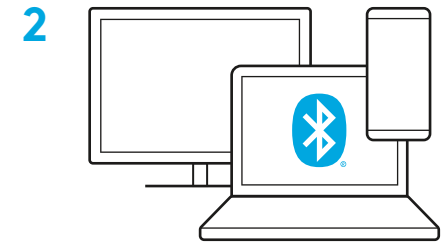
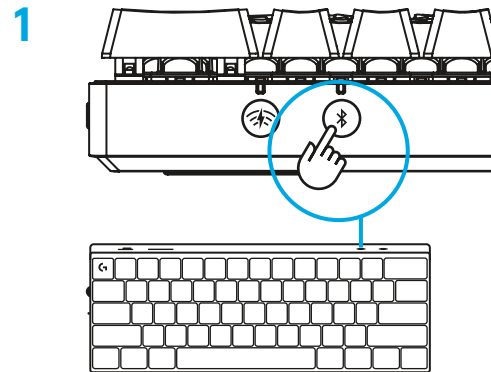

logitechG.com/ghub

Transfira e instale o software G HUB no seu PC/MAC para obter a melhor experiência de jogo (o G HUB tem uma história de integração para as funcionalidades).
Aceda a www.logitechG.com/ghub

CARREGAR O SEU TECLADO

- 1 Introduza o cabo *USB-C* na porta na parte frontal do teclado.

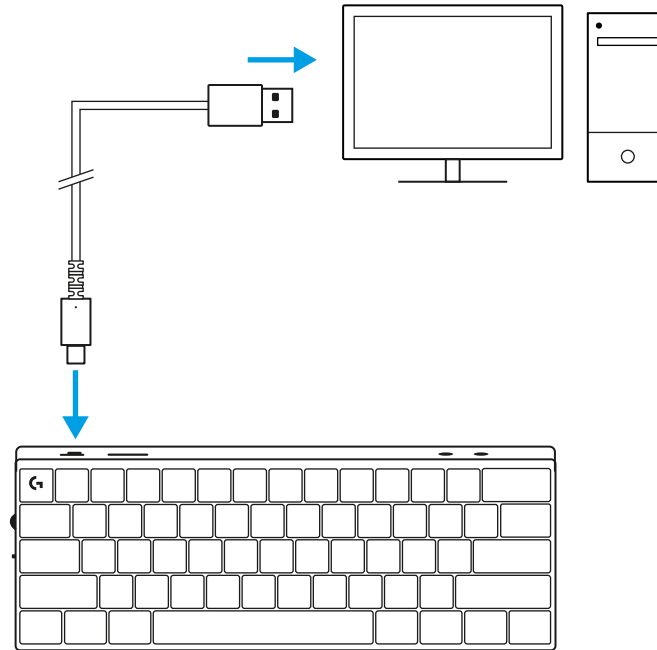

- 2 Ligue o cabo ao seu PC.
A luz do indicador de bateria pulsa a verde durante o carregamento e mantém-se fixa a verde quando está totalmente carregada.

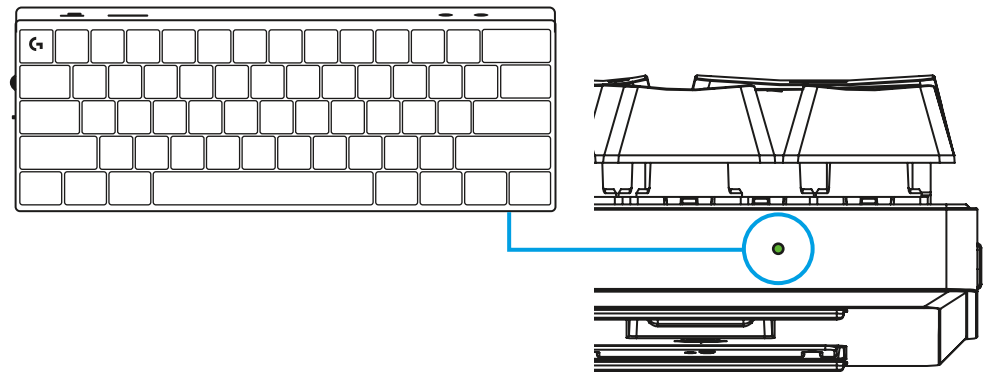

MODO DE JOGO

Ligar o Modo de jogo desativará as funções principais do Windows para evitar a activação acidental.

Também pode desativar teclas diferentes nas definições do Ghub.

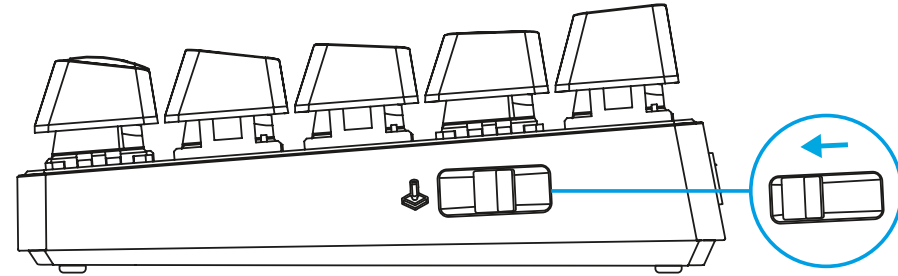

COMBINAÇÕES DE TECLAS

Controlos de multimédia

	Reproduzir/Pausa
	Desactivar som
	Faixa anterior
	Próxima faixa

Teclas ESC

	`
	~



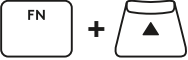
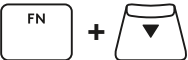
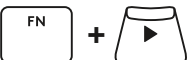
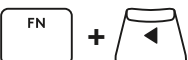





Teclas de seta

	Seta para cima
	Seta para baixo
	Seta para a direita
	Seta para a esquerda







Teclas de função

	Captura de ecrã
	Início
	Página acima
	Página abaixo
	Scroll Lock
	End
	Insert
	Pause/Break



Controlo de iluminação

 + 	Diminuir a luminosidade do teclado
 + 	Aumentar a luminosidade do teclado
 + 	Percorrer pelo efeito de animação
 + 	Percorrer pelos parâmetros de animação

Alterações de perfil

 +   +   + 	Active um dos três perfis de memória integrados
-------------------------------------------------------------------------------------------------------------------------------------------------------------------------------------------------------------------------------------------------------------------------------------------------------------------------------------------------------------------------------------------------------------------------------------------------------------------------------------------------------------------------------------	-------------------------------------------------

Ligar/desligar personalização de teclas completa

 + 	Activar personalização de teclas completa
	Activar para alternar entre o esquema predefinido e personalizado

PRODUCTOVERZICHT

Bovenaanzicht

- 1 Aan-/uitschakelaar
- 2 Typ-C-poort
- 3 *BLUETOOTH*[®]-knop
- 4 LIGHTSPEED-knop
- 5 Schakelaar voor gamemodus
- 6 Stroomindicator
- 7 Volumeregelaar
- 8 Statuslampje voor Caps Lock

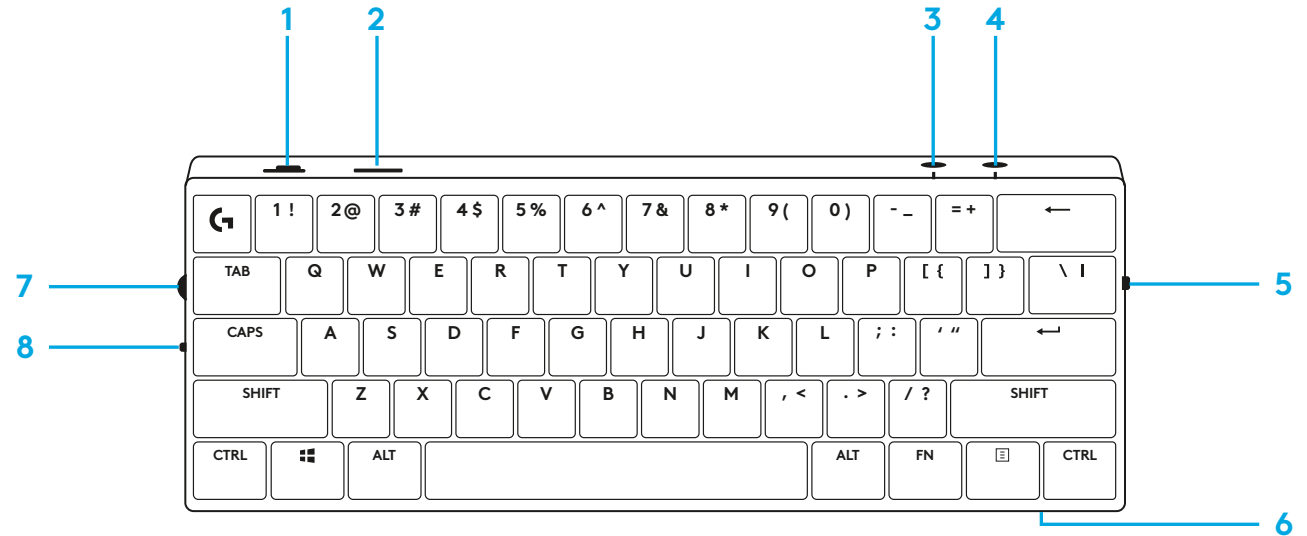

Onderaanzicht:

- 1 Opslag voor dongle
- 2 Verstelbare pootjes.

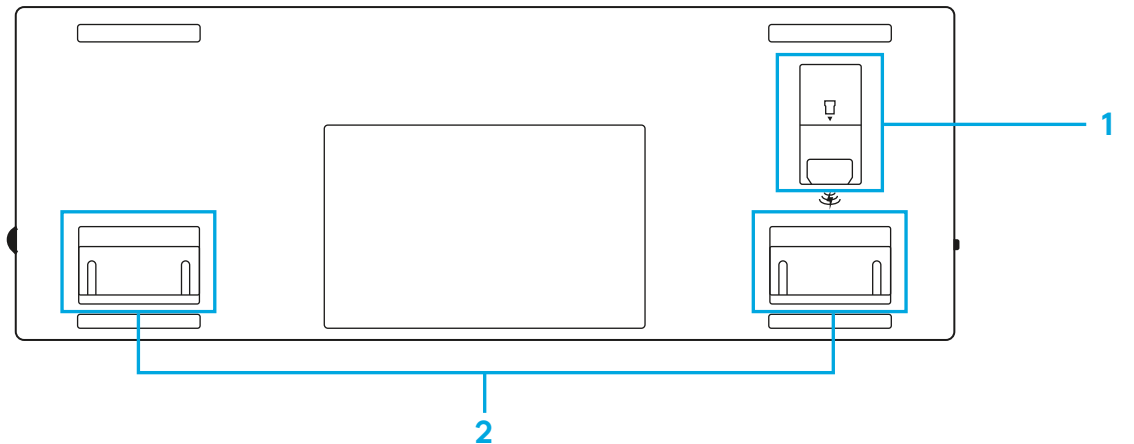

LIGHTSPEED-VERBINDING

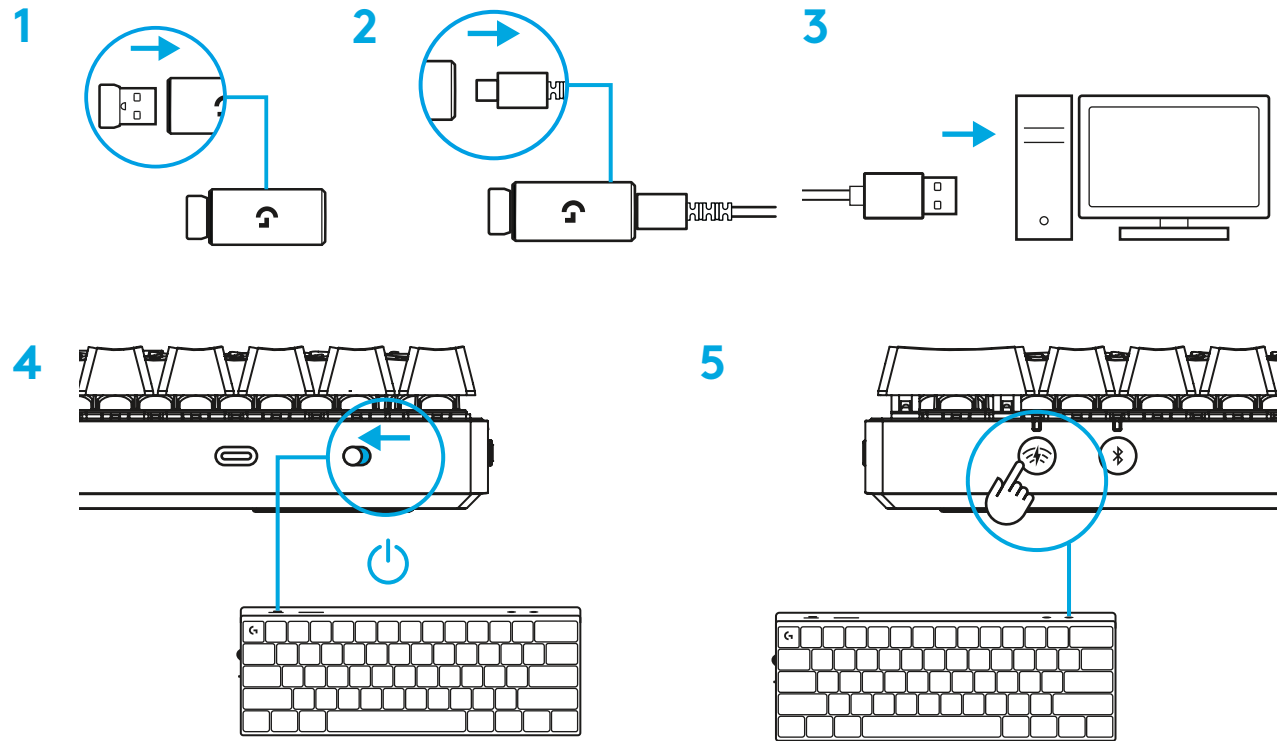

Download en installeer de G HUB-software op je pc/Mac voor de beste gamingervaring (G HUB heeft een onboardingtutorial voor functies).
Ga naar www.logitechG.com/ghub

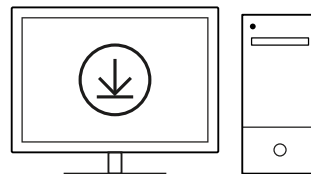

logitechG.com/ghub

BLUETOOTH®-VERBINDING

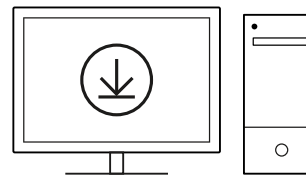
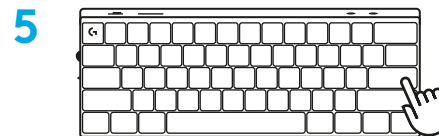
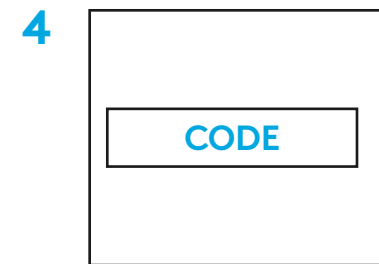
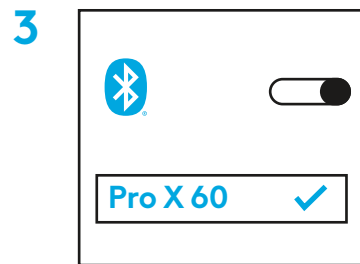
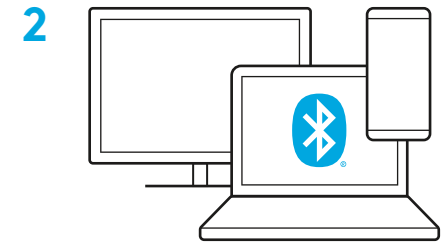
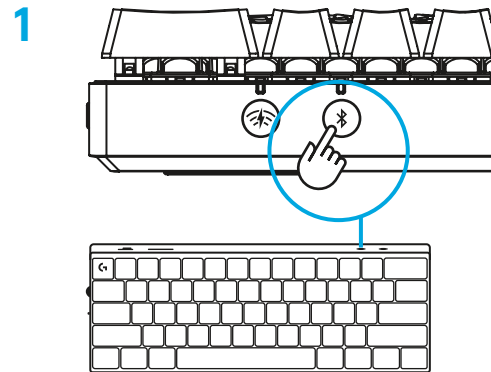

logitechG.com/ghub

Download en installeer de G HUB-software op je pc/
Mac voor de beste gamingervaring (G HUB heeft
een onboardingtutorial voor functies).
Ga naar www.logitechG.com/ghub

JE TOETSENBORD OPLADEN

- 1 Steek de *USB-C*-kabel in de poort aan de voorkant van het toetsenbord.

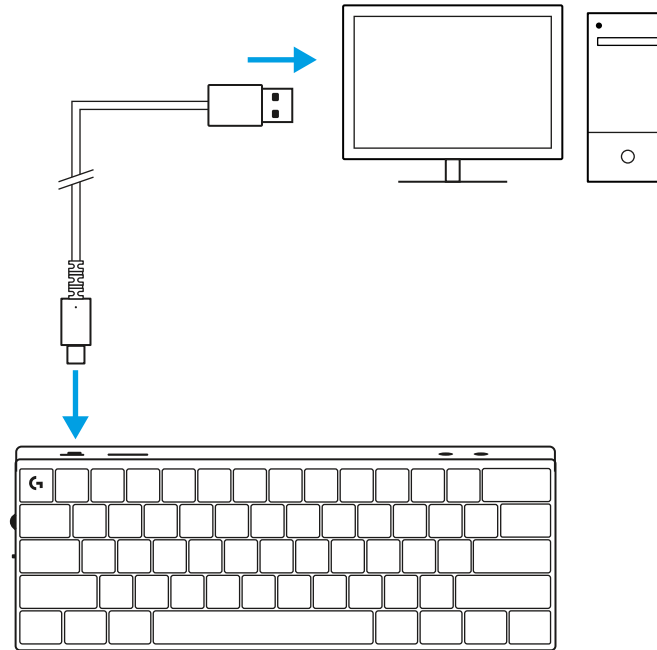

- 2 Sluit de kabel op je pc aan.
Het batterijlampje pulseert groen tijdens het opladen en blijft groen branden wanneer de batterij volledig is opgeladen.

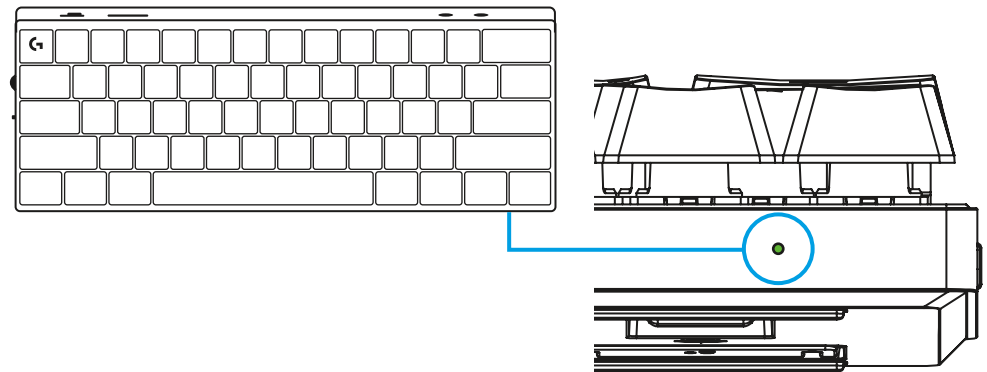

GAMEMODUS





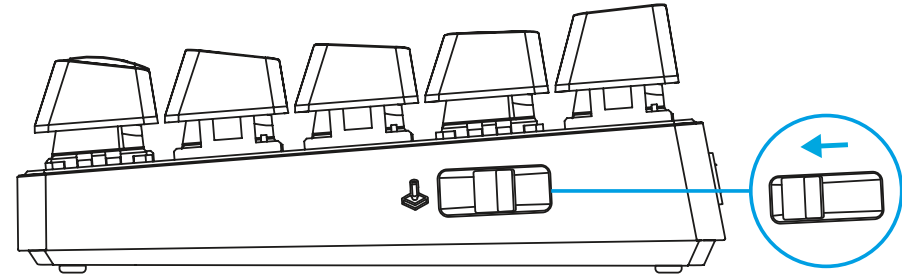



Wanneer je gamemodus inschakelt, worden Windows-toetsfuncties uitgeschakeld om te voorkomen dat je deze per ongeluk activeert.

Je kunt ook andere toetsen uitschakelen in de G HUB-instellingen.







TOETSCOMBINATIES

Mediaknoppen

 + 	Afspelen/pauzeren
 + 	Dempen
 + 	Vorig nummer
 + 	Volgend nummer

Esc-toetsen

 + 	`
 +  + 	~

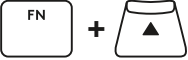
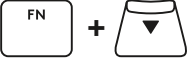
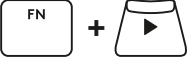
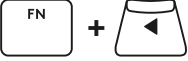

Pijltjestoetsen

	Pijl omhoog
	Pijl omlaag
	Pijl naar rechts
	Pijl naar links

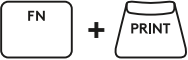
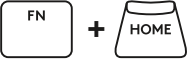
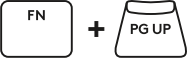
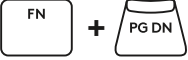
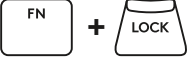
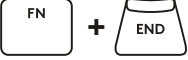
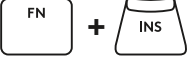
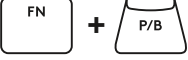

Functietoetsen

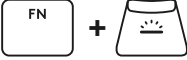
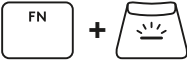
	Screenshot
	Home
	Pagina omhoog
	Pagina omlaag
	Scroll Lock
	End
	Insert
	Pause/break

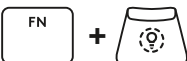
Verlichtingsknoppen

	De helderheid van het toetsenbord verlagen
	De helderheid van het toetsenbord verhogen
	Door het animatie-effect bladeren
	Door de animatieparameters bladeren

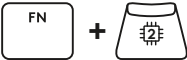
Profielchakelaars

  	Activeer 1 van de 3 ingebouwde geheugenprofielen
-------------------------------------------------------------------------------------------------------------------------------------------------------------------------------------------------------------------------------------------------------------------	--------------------------------------------------

Volledige toetsaanpassing aan/uit

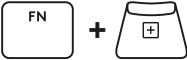
	Volledige toetsaanpassing inschakelen
	Schakelen tussen Standaard en Aangepaste indeling

PRODUKTÖVERSIKT

Ovanifrån

- 1 Strömbrytare
- 2 Typ-C-port
- 3 **BLUETOOTH**[®]-knapp
- 4 LIGHTSPEED-knapp
- 5 Omkopplare för spelläge
- 6 Indikatorlampa för ström
- 7 Volymkontroll
- 8 Caps Lock-indikator



Underifrån

- 1 Förvaring för dongel
- 2 Vinklingsbara ben

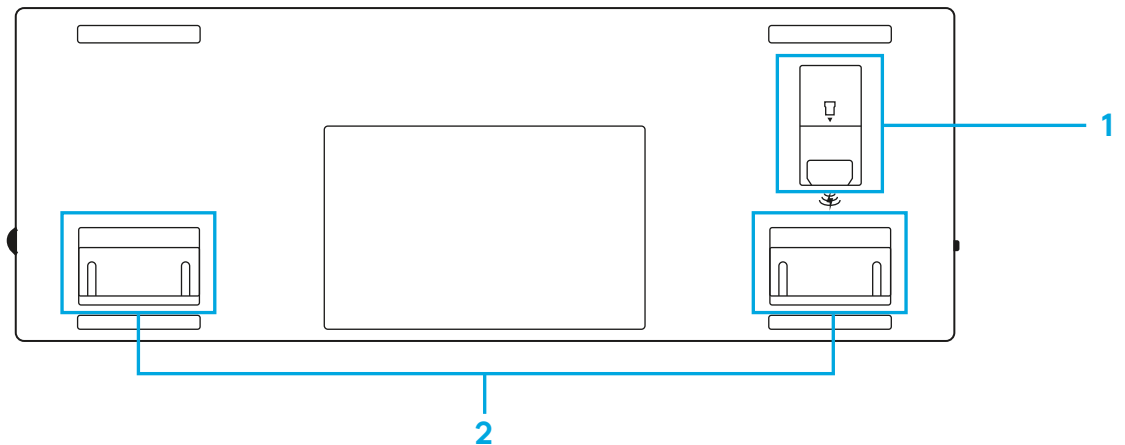

LIGHTSPEED-ANSLUTNING

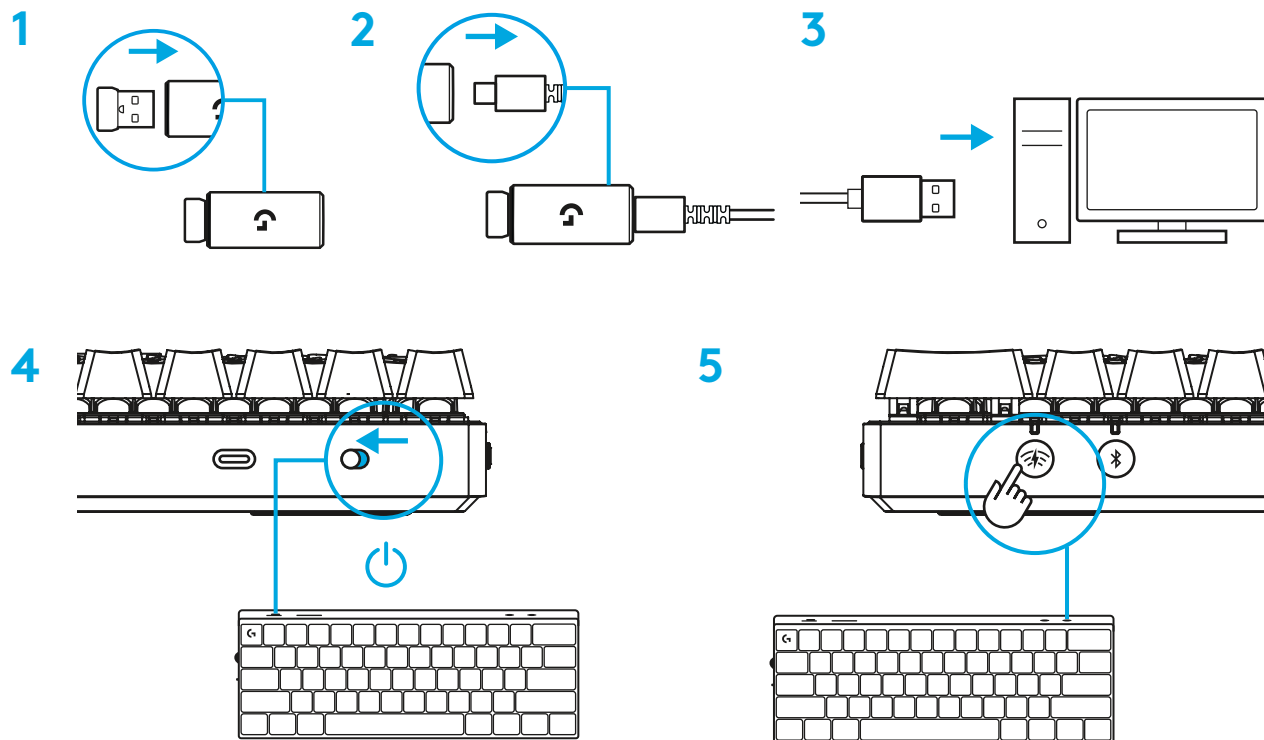

Ladda ner och installera G HUB-programvaran till din PC/MAC för bästa spelupplevelse (G HUB har en introduktionsvideo för funktioner). Gå till www.logitechG.com/ghub

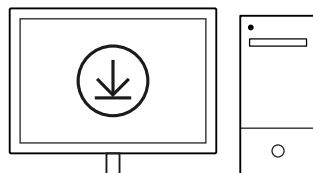

logitechG.com/ghub

BLUETOOTH®-ANSLUTNING

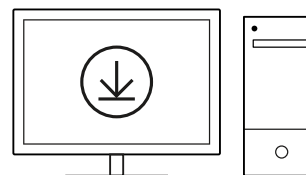
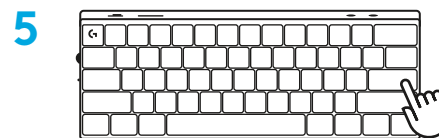
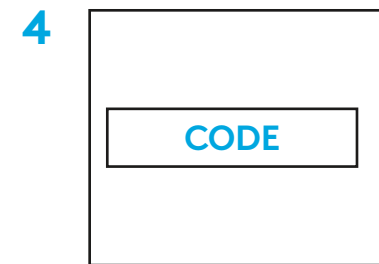
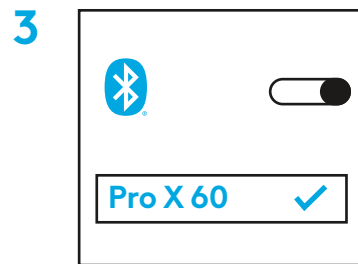
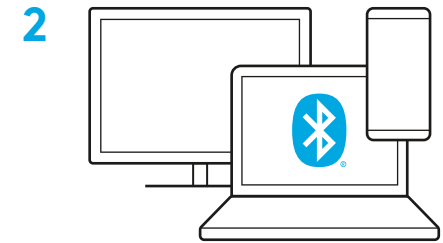
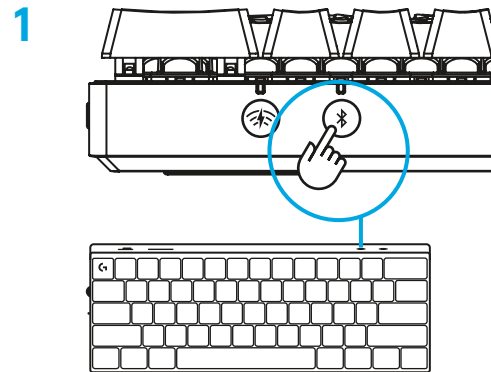

logitechG.com/ghub

Ladda ner och installera G HUB-programvaran till din PC/MAC för bästa spelupplevelse (G HUB har en introduktionsvideo för funktioner).
Gå till www.logitechG.com/ghub

LADDA TANGENTBORDET

1 För in *USB-C*-sladden i porten på tangentbordets övre del.

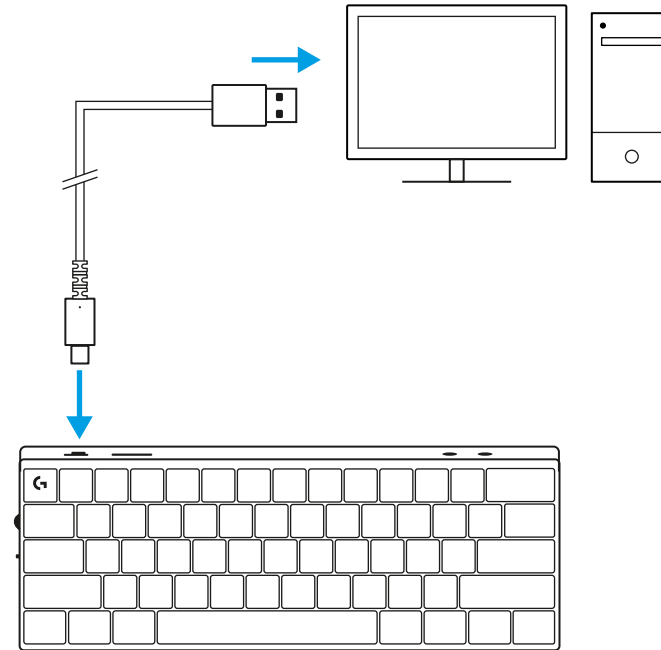

2 Anslut sladden till datorn.
Batteriindikatorlampan blinkar i grönt under laddning
och lyser med ett fast grönt sken när tangentbordet
är fulladdat.

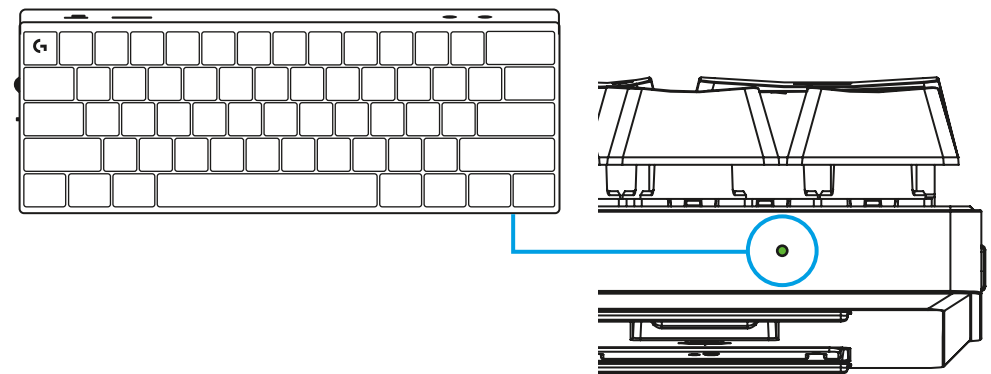

SPELLÄGE





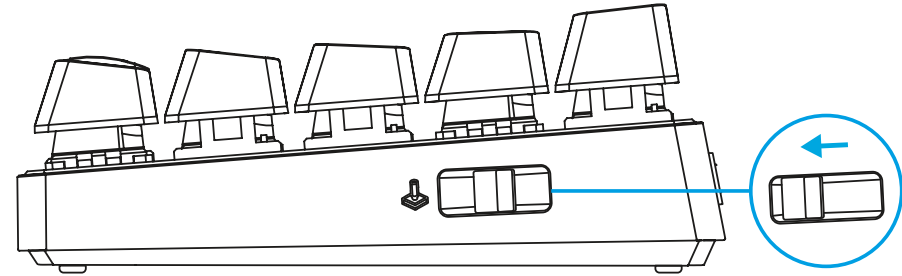



Vid aktivering av spelläget inaktiveras Windows' knappfunktioner för att undvika att de aktiveras av misstag.

Du kan också inaktivera olika knappar i G HUB-inställningarna.







KNAPPKOMBINATIONER

Mediekontroller

 + 	Spela upp/pausa
 + 	Ljud av
 + 	Föregående spår
 + 	Nästa spår

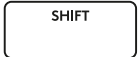
ESC-knappar

 + 	~
 +  + 	~

Piltangenter

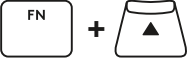
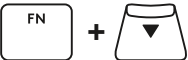
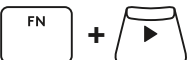
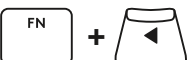
	Pil upp
	Pil ner
	Pil höger
	Pil vänster

Funktionsknappar

	Skärmbild
	Hem
	Sida upp
	Sida ner
	Scroll Lock
	Avsluta
	Infoga
	Pausa

Ljusreglage

	Minska tangentbordets ljusstyrka
	Öka tangentbordets ljusstyrka
	Bläddra genom animeringseffekterna
	Bläddra genom animeringsparametrarna

Profilväxel

  	Aktivera en av de tre inbyggda minnesprofilerna
-------------------------------------------------------------------------------------------------------------------------------------------------------------------------------------------------------------------------------------------------------------------	-------------------------------------------------

Fullständig knappanpassning av/på

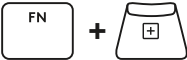
	Aktivera fullständig knappanpassning
	Flytta för att växla mellan standard och anpassad layout

PRODUKTOVERSIGT

Set fra oven

- 1 Tænd/sluk-knap
- 2 Type-C-port
- 3 **BLUETOOTH**[®]-knap
- 4 **LIGHTSPEED**-knap
- 5 Funktionsomskifter
- 6 Strømindikator
- 7 Lydstyrkerulleknap
- 8 Caps Lock-indikator

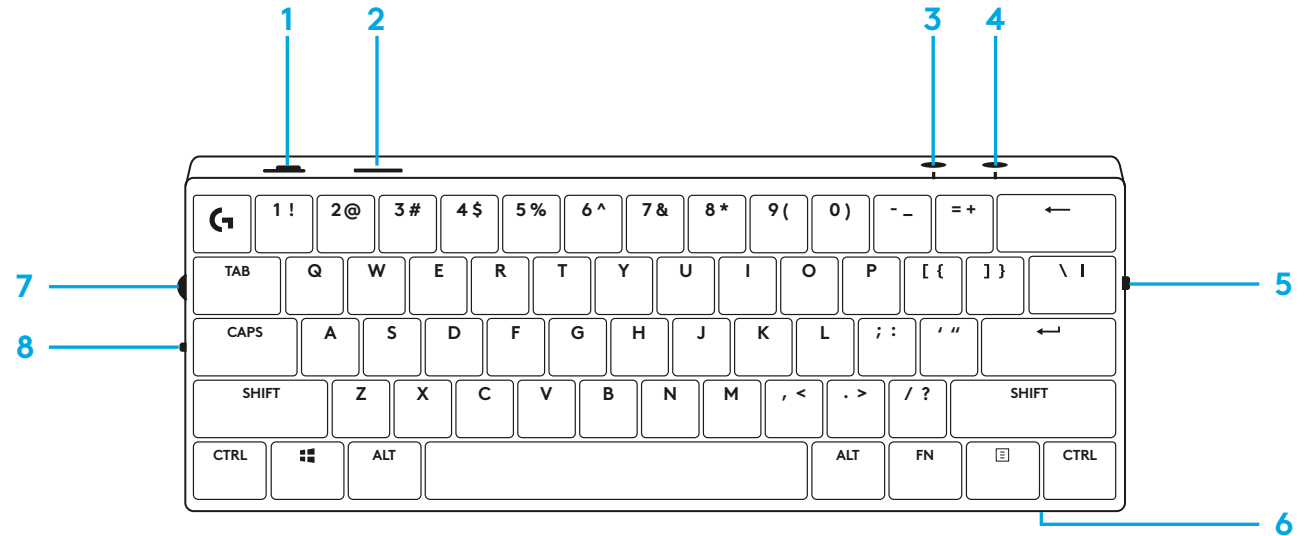

Set nedefra

- 1 Dongle-lagerplads
- 2 Ben, der kan slås ud.

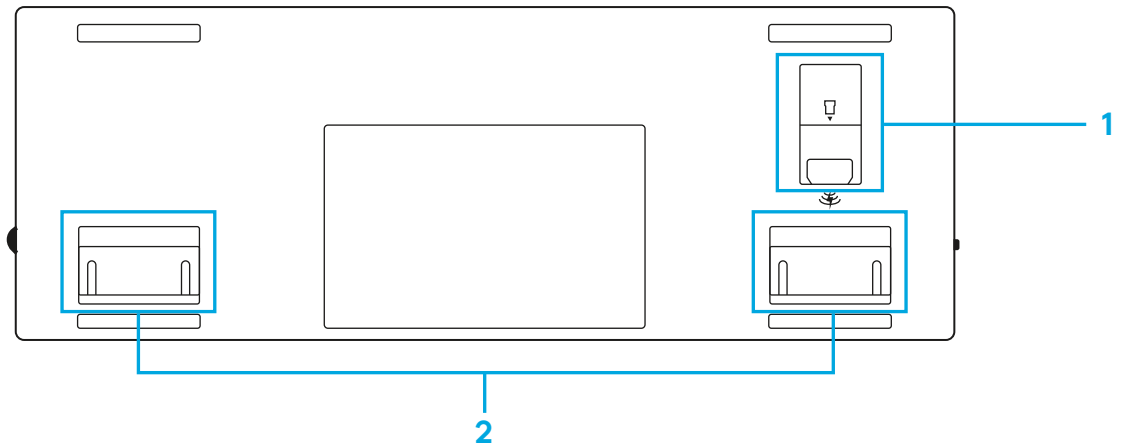

LIGHTSPEED-FORBINDELSE

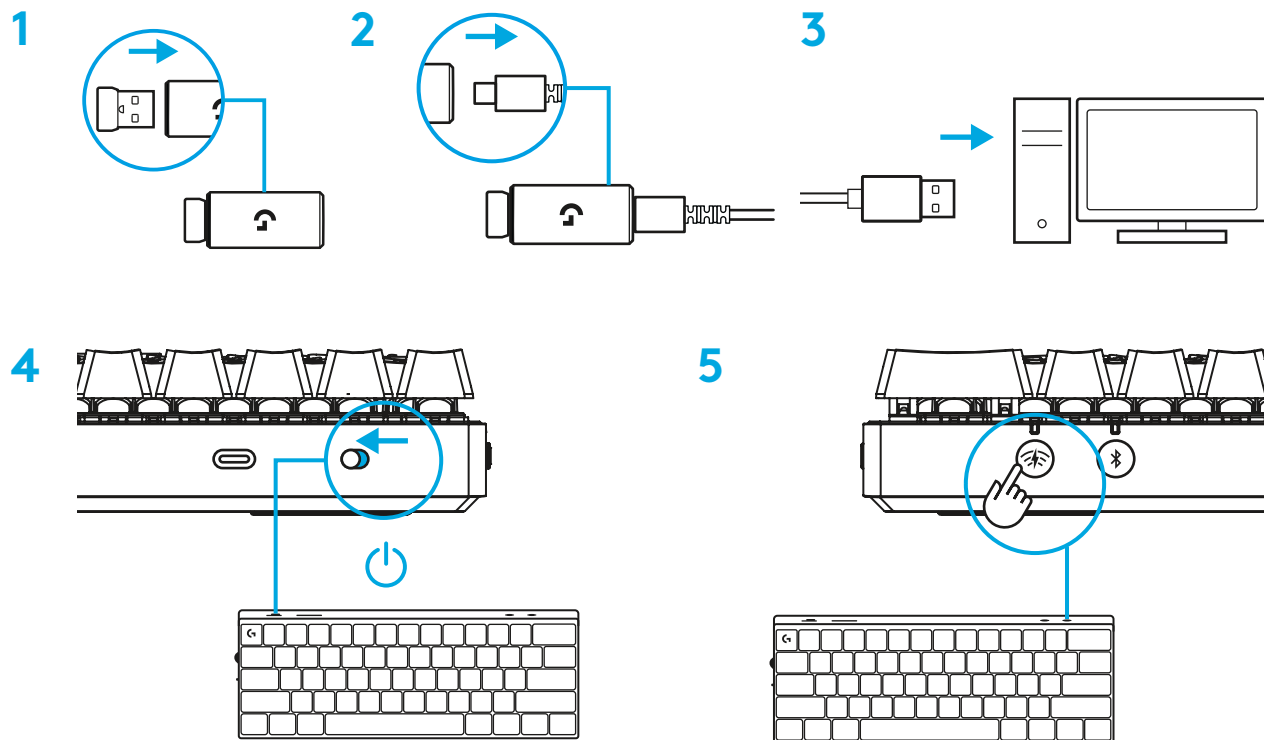

Download og installér G HUB-software på din pc/Mac for at få den bedst mulige gamingoplevelse (Der er en introduktionsvejledning om funktionerne i G HUB'en).
Gå til www.logitechG.com/ghub

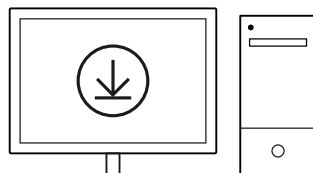

logitechG.com/ghub

BLUETOOTH®-FORBINDELSE

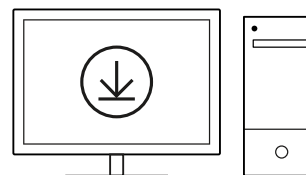
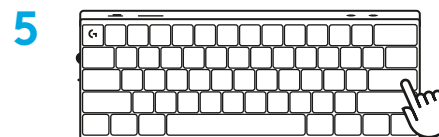
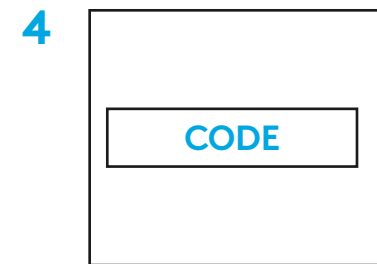
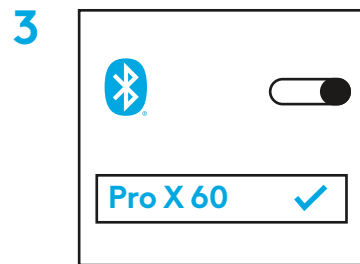
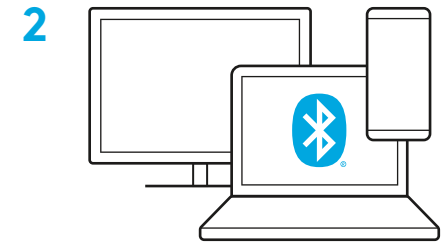
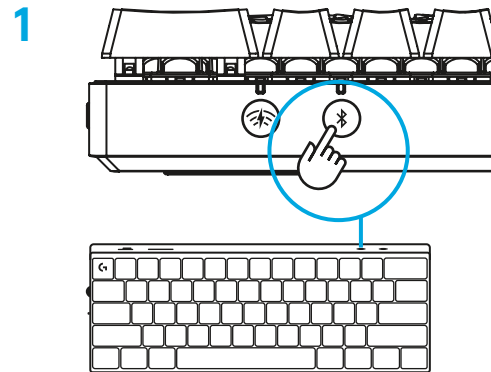

logitechG.com/ghub

Download og installér G HUB-software på din pc/Mac for at få den bedst mulige gamingoplevelse (Der er en introduktionsvejledning om funktionerne i G HUB'en). Gå til www.logitechG.com/ghub

SÅDAN OPLADER DU TASTATURET

1 Sæt *USB-C*-kablet i porten på forsiden af tastaturet.

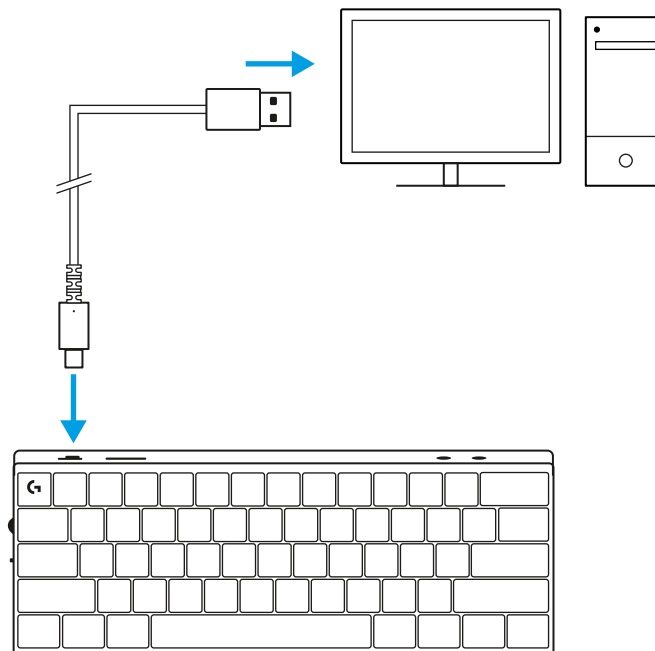

2 Slut kablet til din pc.
Batteriindikatorlyset blinker grønt under opladning og lyser konstant grønt, når det er fuldt opladet.

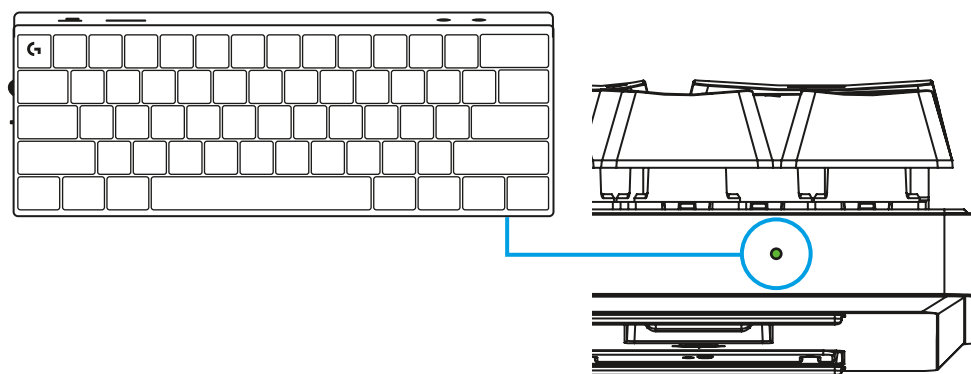

SPILTILSTAND

Når du tænder for spiltilstand, deaktiveres Windows-tasternes funktioner for at undgå utilsigtet udløsning.

Du kan også deaktivere forskellige taster i Ghub-indstillingerne.

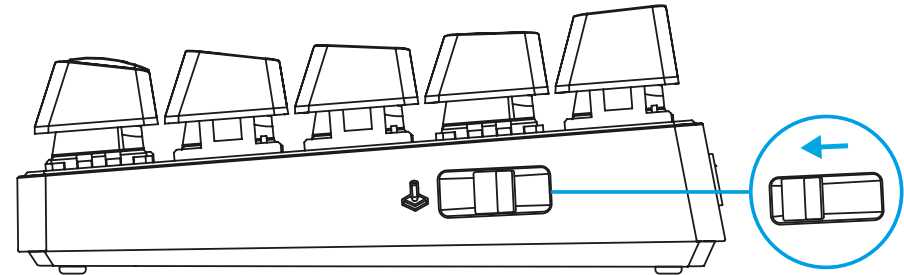





TASTEKOMBINATIONER





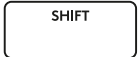



Medieknapper

 + 	Afspil/pause
 + 	Slå lyden fra
 + 	Forrige nummer
 + 	Næste nummer

















Esc-taster

 + 	`
 +  + 	~









Piletaster

 + 	Pil op
 + 	Pil ned
 + 	Højre pil
 + 	Venstre pil





Funktionstaster

 + 	Screenshot
 + 	Startside
 + 	En side op
 + 	En side ned
 + 	Scroll Lock
 + 	Afslut
 + 	Indsæt
 + 	Pause/afbrydelse



Styring af belysning

 + 	Reducer tastaturlysstyrke
 + 	Øg tastaturlysstyrke
 + 	Gennemløb animationseffekten
 + 	Gennemløb animationsparametrene

Skift profil

 + 	Aktivér en af de tre indbyggede profiler
 + 	
 + 	

Fuld tastaturtilpasning til/fra

 + 	Aktivér fuld tastaturtilpasning
	Skift mellem layouttilstand Standard og Brugertilpasset

PRODUKTOVERSIKT

Sett ovenfra

- 1 Av/på-knapp
- 2 Type C-port
- 3 *BLUETOOTH*[®]-knapp
- 4 LIGHTSPEED-knapp
- 5 Spillmodusbryter
- 6 Strømindikator
- 7 Volumhjul
- 8 Caps Lock-indikator

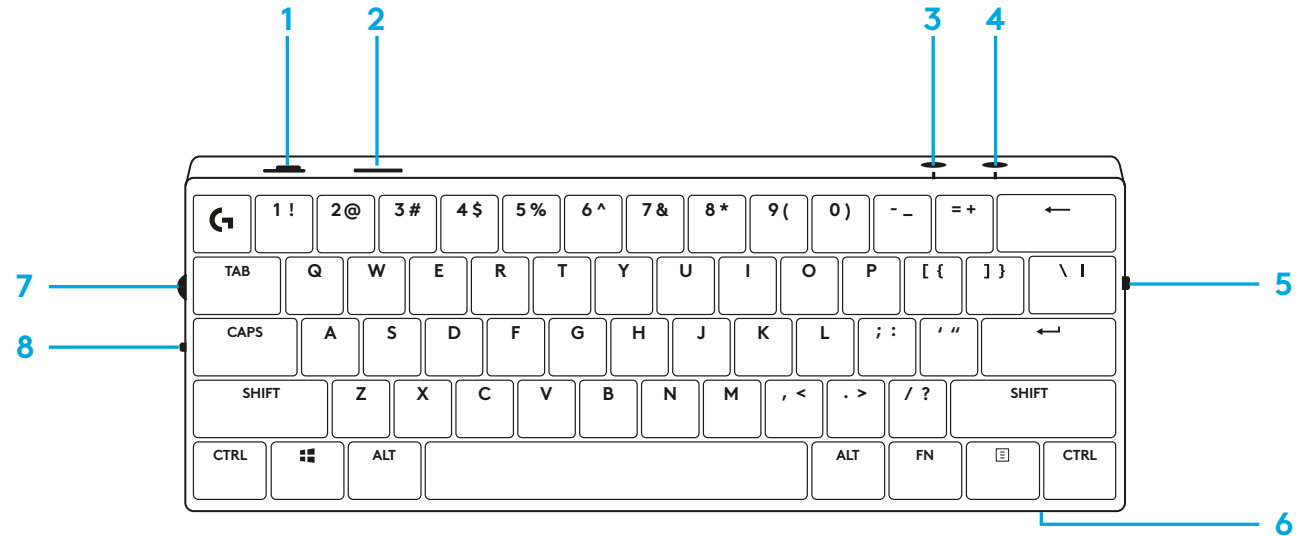

Sett fra undersiden

- 1 Oppbevaring av maskinvarelås
- 2 Nedfellbare tastaturstøtter

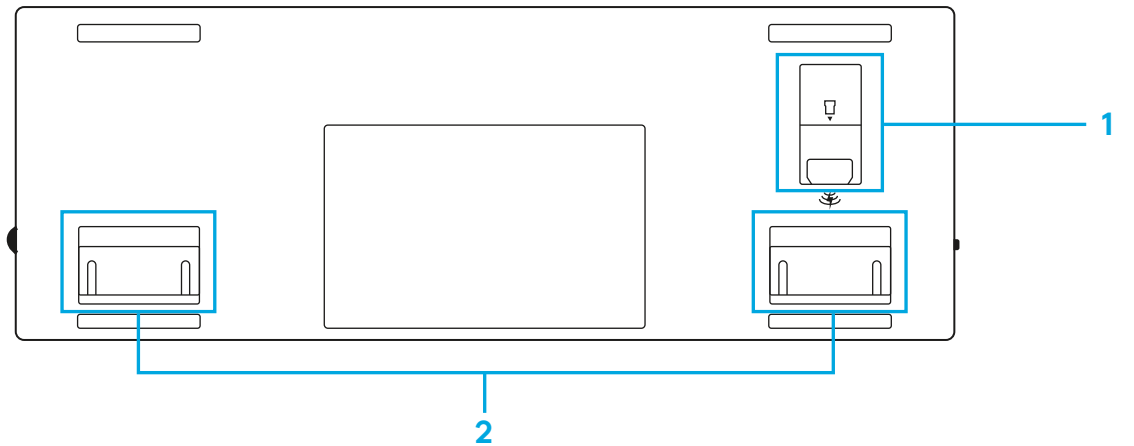

LIGHTSPEED-TILKOBLING

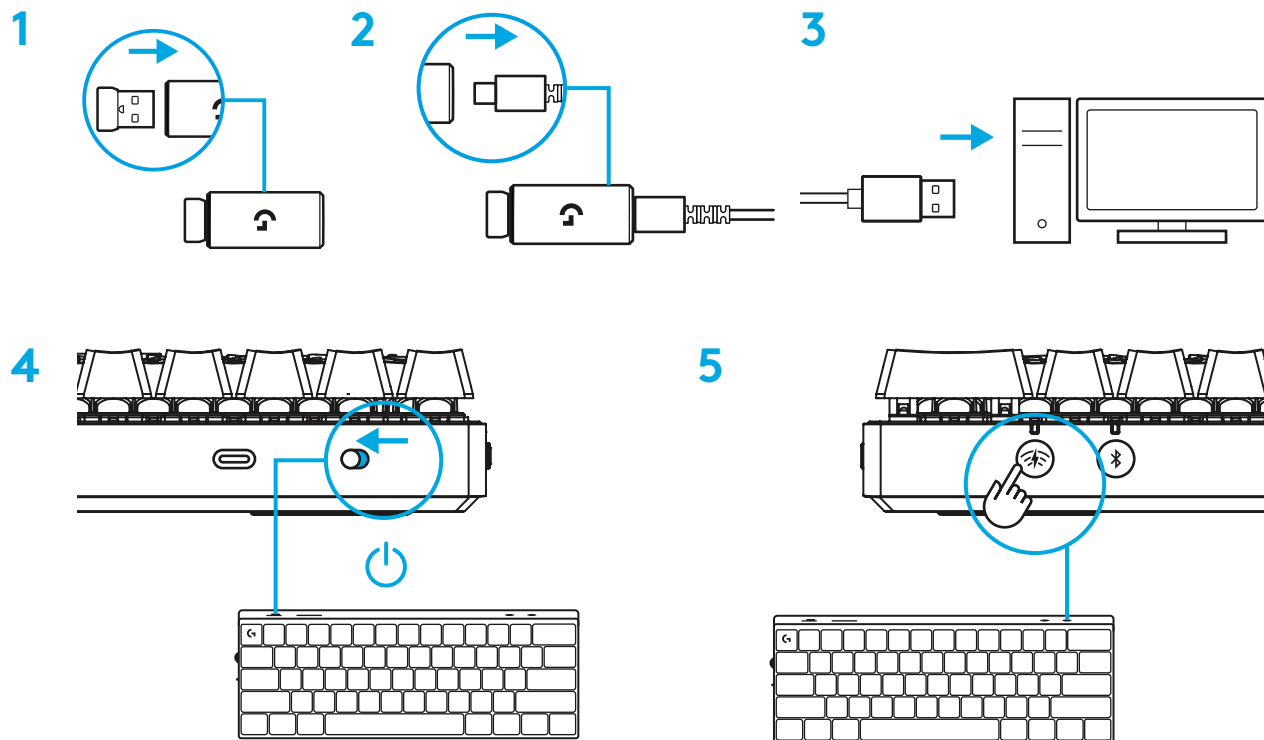

Last ned og installer G HUB-programvare på din PC/MAC for den beste spillopplevelsen (G HUB har en innføringshistorie for funksjoner). Gå til www.logitechG.com/ghub

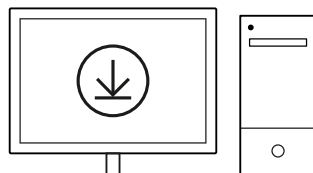

logitechG.com/ghub

BLUETOOTH®-TILKOBLING

1

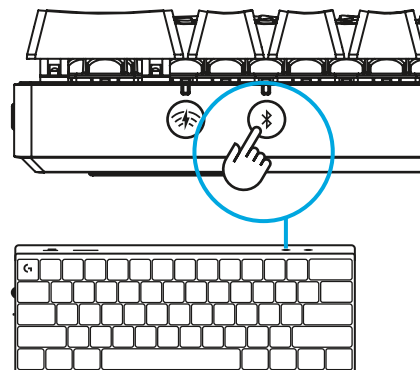

2

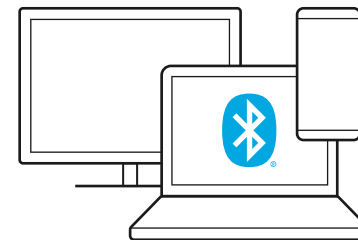

3

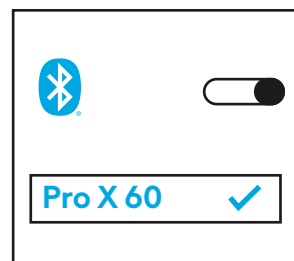

4

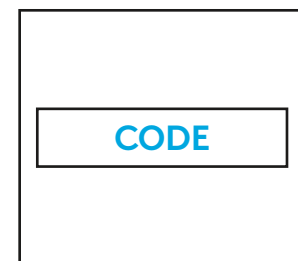

5

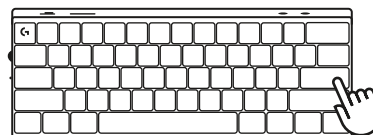

Last ned og installer G HUB-programvare på din PC/
MAC for den beste spillopplevelsen (G HUB har
innføringshistorie for funksjoner).
Gå til www.logitechG.com/ghub

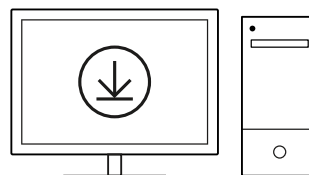

logitechG.com/ghub

LADE TASTATURET

1 Sett inn *USB-C*-kabelen i porten foran på tastaturet.

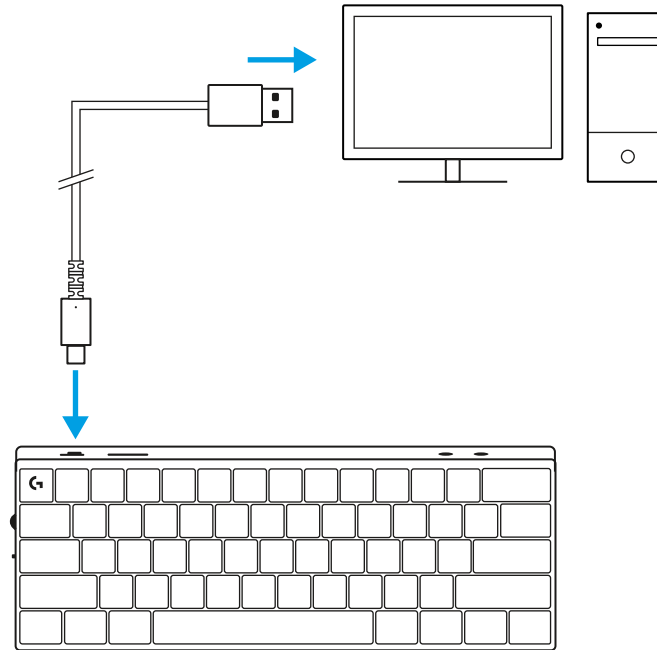

2 Koble kabelen til PC-en.
Batteriindikatoren pulserer grønt under ladingen og lyser fast grønt når det er fulladet.

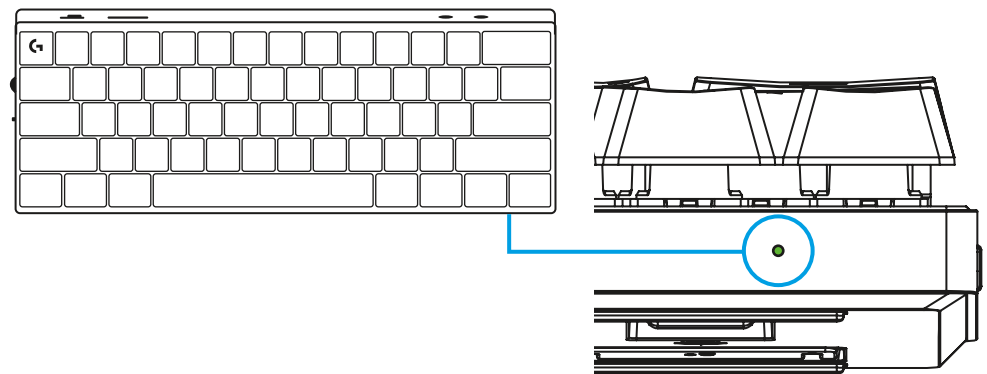

SPILLMODUS



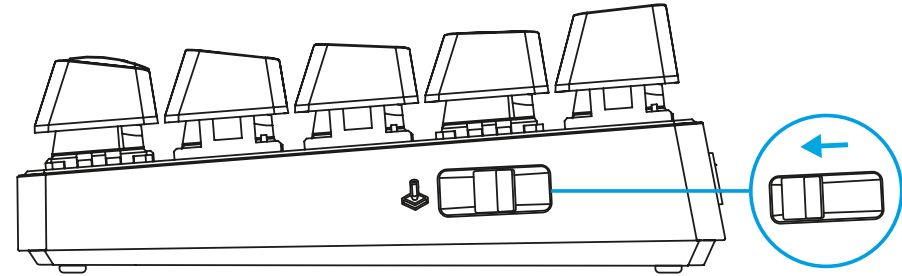

Aktivering av Spillmodus vil deaktivere tastefunksjonene i Windows for å unngå utilsiktet utløsning.

Du kan også deaktivere ulike taster i Ghub-innstillinger.





TASTEKOMBINASJONER









Mediekontrollere

FN + 	Spill av/pause
FN + 	Demp
FN + 	Forrige spor
FN + 	Neste spor

















Esc-taster

FN + 	`
FN + SHIFT + 	~

Piltaster

 + 	Pil opp
 + 	Pil ned
 + 	Pil høyre
 + 	Pil venstre

Funksjonstaster

 + 	Screenshot
 + 	Home
 + 	Page up
 + 	Page down
 + 	Scroll Lock
 + 	End
 + 	Insert
 + 	Pause/Break

Belysningskontrollere

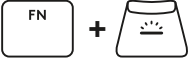
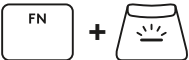
	Reduser tastaturets lysstyrke
	Øk tastaturets lysstyrke
	Bla gjennom animasjonseffekter
	Bla gjennom animasjonsparametre

Profilbrytere

  	Aktiver en av de tre innebygde minneprofilene
-------------------------------------------------------------------------------------------------------------------------------------------------------------------------------------------------------------------------------------------------------------------	-----------------------------------------------

Full tastetilpasning på/av

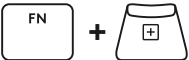
	Slå på full tastetilpasning
	Veksle for å bytte mellom standard og tilpasset oppsett

TUOTTEEN YLEISKATSAUS

Näkymä ylhäältä

- 1 Virtakytin
- 2 USB-C-portti
- 3 **BLUETOOTH**[®]-painike
- 4 **LIGHTSPEED**-painike
- 5 Pelitilan valinta
- 6 Virran merkkivalo
- 7 Äänenvoimakkuuden rullasäädin
- 8 Caps Lock -merkkivalo



Näkymä alta

- 1 Sovittimen säilytys
- 2 Taittavat jalat

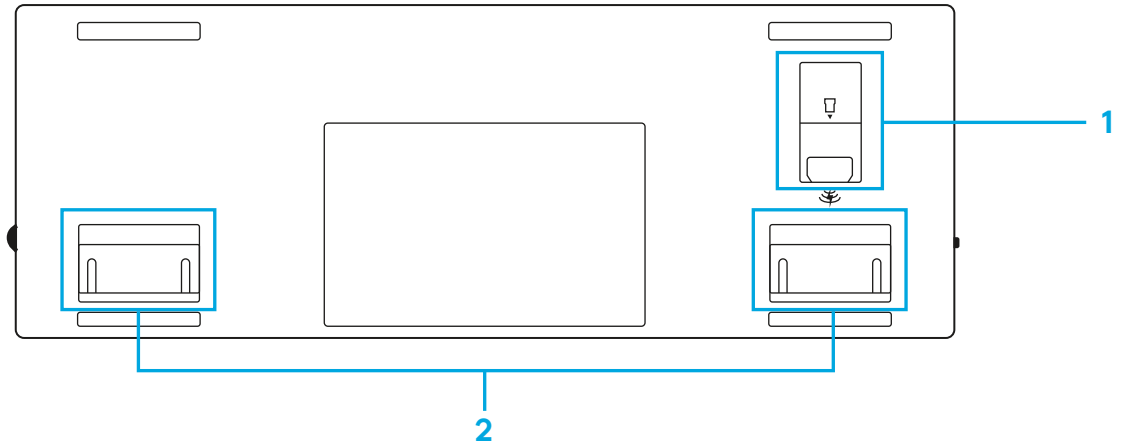

LIGHTSPEED-YHTEYS

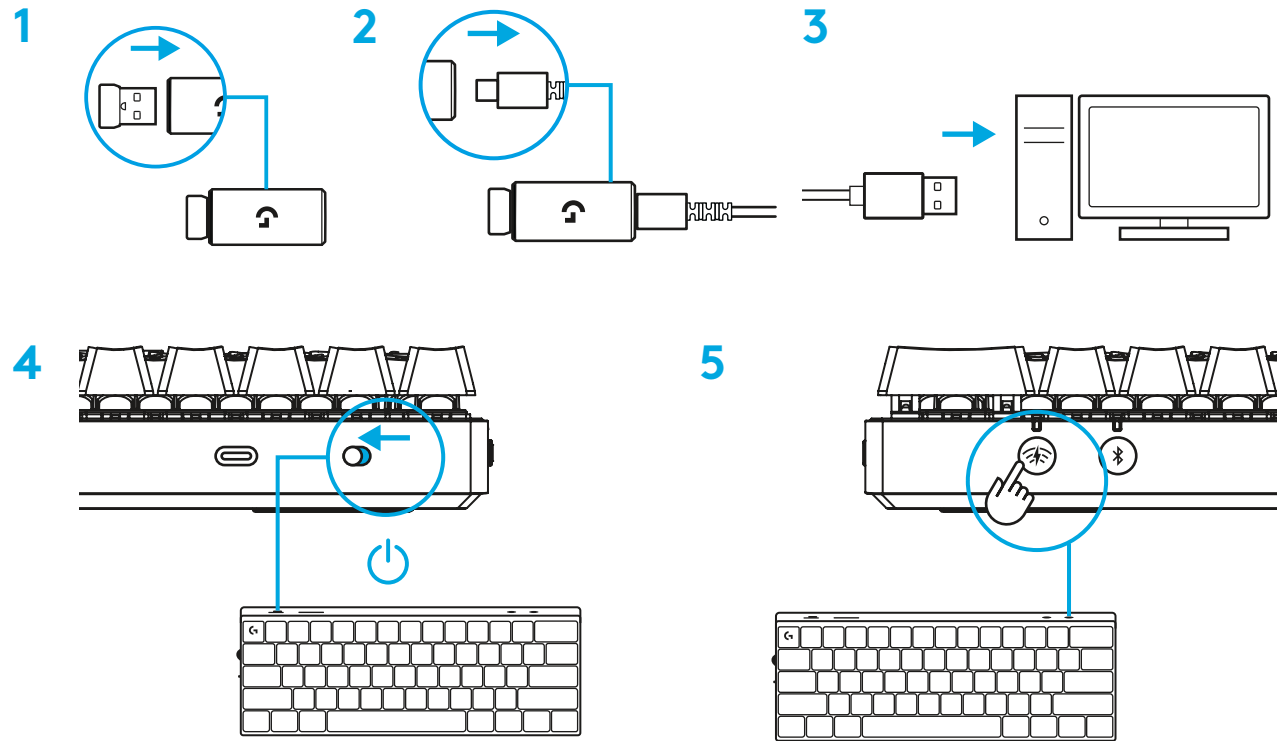

Lataa ja asenna G HUB -ohjelmisto PC- tai MAC-tietokoneeseen saadaksesi parhaan mahdollisen pelikokemuksen (G HUB -ohjelmisto opastaa ominaisuuksien käyttöönotossa). Siirry osoitteeseen www.logitechG.com/ghub

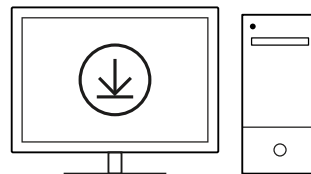

logitechG.com/ghub

BLUETOOTH®-YHTEYS

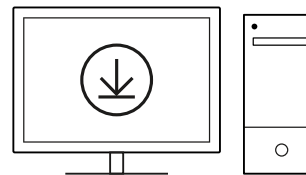
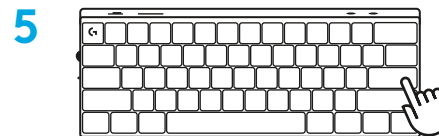
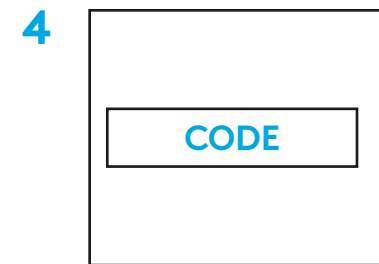
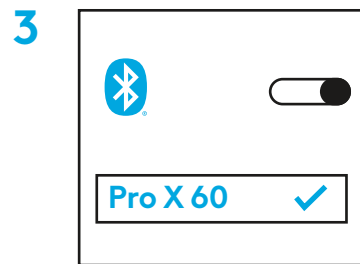
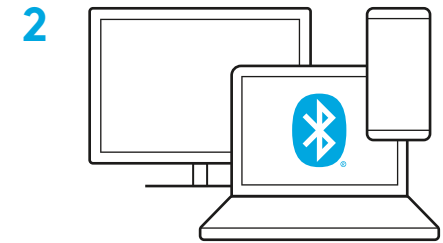
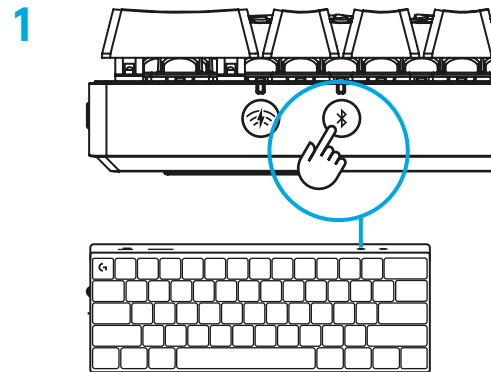

[logitechG.com/g Hub](https://www.logitechG.com/g Hub)

Lataa ja asenna G HUB -ohjelmisto PC- tai MAC-tietokoneeseen saadaksesi parhaan mahdollisen pelikokemuksen (G HUB -ohjelmisto opastaa ominaisuuksien käyttöönotossa).
Siirry osoitteeseen www.logitechG.com/g Hub

NÄPPÄIMISTÖN LATAAMINEN

1 Kiinnitä *USB-C*-johto näppäimistön etuosan liittimeen.

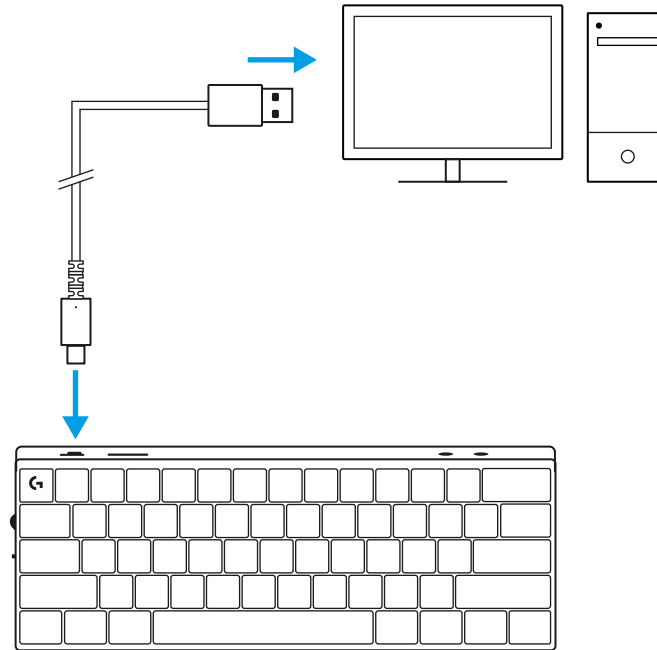

2 Liitä johto tietokoneeseen.

Akun merkkivalo sykkii ladattaessa vihreänä ja palaa tasaisesti vihreänä, kun akku on ladattu täyteen.

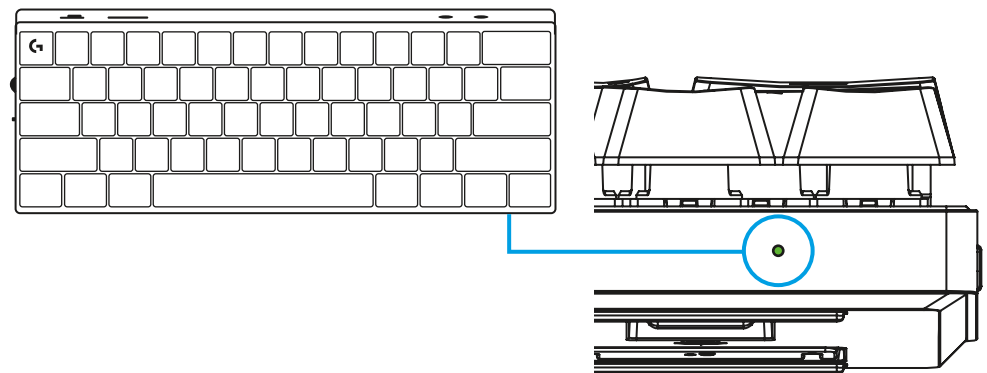

PELITILA

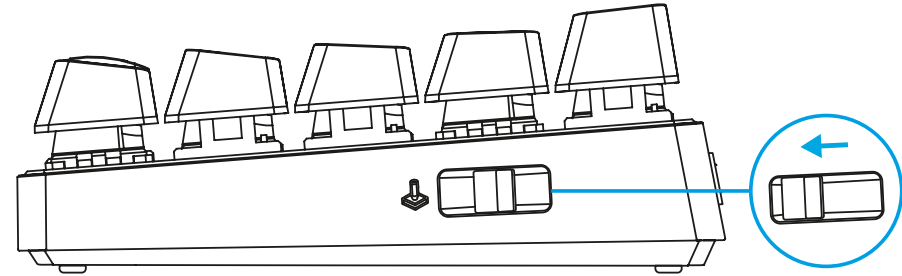

Pelitila poistaa Windows-näppäimen käytöstä vahinkotoimintojen estämiseksi.

Lisäksi voit poistaa muita näppäimiä käytöstä G Hubin asetuksista.





NÄPPÄINYHDISTELMÄT

Mediapainikkeet

FN + 	Toisto/tauko
FN + 	Mykistys
FN + 	Edellinen raita
FN + 	Seuraava raita

Esc-näppäimet

FN + 	`
FN + SHIFT + 	~

Nuolinäppäimet

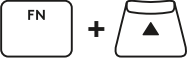
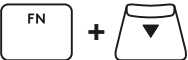
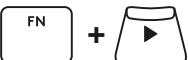
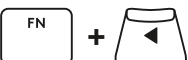
	Nuoli ylös
	Nuoli alas
	Nuoli oikealle
	Nuoli vasemmalle

Toimintopainikkeet

	Näyttökuva
	Alkuun
	Sivu ylös
	Sivu alas
	Vierityksen esto
	Loppuun
	Lisää
	Tauko

Valaistuksen säätimet

	Himmennä näppäimistön valaistusta
	Kirkasta näppäimistön valaistusta
	Selaa animaatiotehosteita
	Selaa animaatioparametrejä

Profiilien vaihto

	Aktivoi yksi kolmesta sisäisestä muistiprofiilista
	
	

Täysi näppäinten mukautus päällä / poissa päältä

	Laita täysi näppäinten mukautus päälle
	Vaihda oletusasettelun ja mukautetun asettelun välillä

ΕΠΙΣΚΟΠΗΣΗ ΠΡΟΪΟΝΤΟΣ

Πάνω όψη

- 1 Διακόπτης ενεργοποίησης/ απενεργοποίησης
- 2 Θύρα Type-C
- 3 Κουμπί *BLUETOOTH*[®]
- 4 Κουμπί *LIGHTSPEED*
- 5 Διακόπτης λειτουργίας παιχνιδιού
- 6 Ενδεικτική λυχνία λειτουργίας
- 7 Ροδέλα ρύθμισης έντασης ήχου
- 8 Ενδεικτική λυχνία για το πλήκτρο Caps Lock



Κάτω όψη

- 1 Χώρος αποθήκευσης dongle
- 2 Υποστηρίγματα με δυνατότητα κλίσης

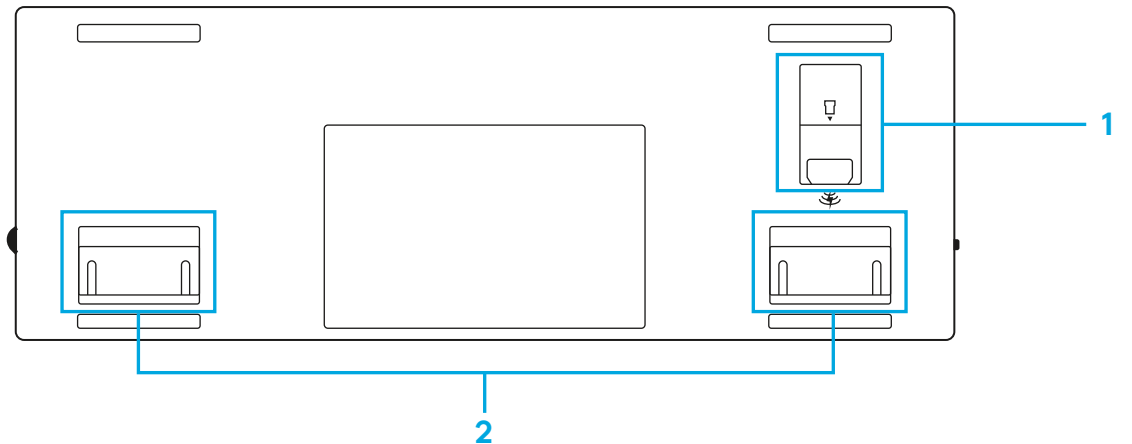

ΣΥΝΔΕΣΗ LIGHTSPEED

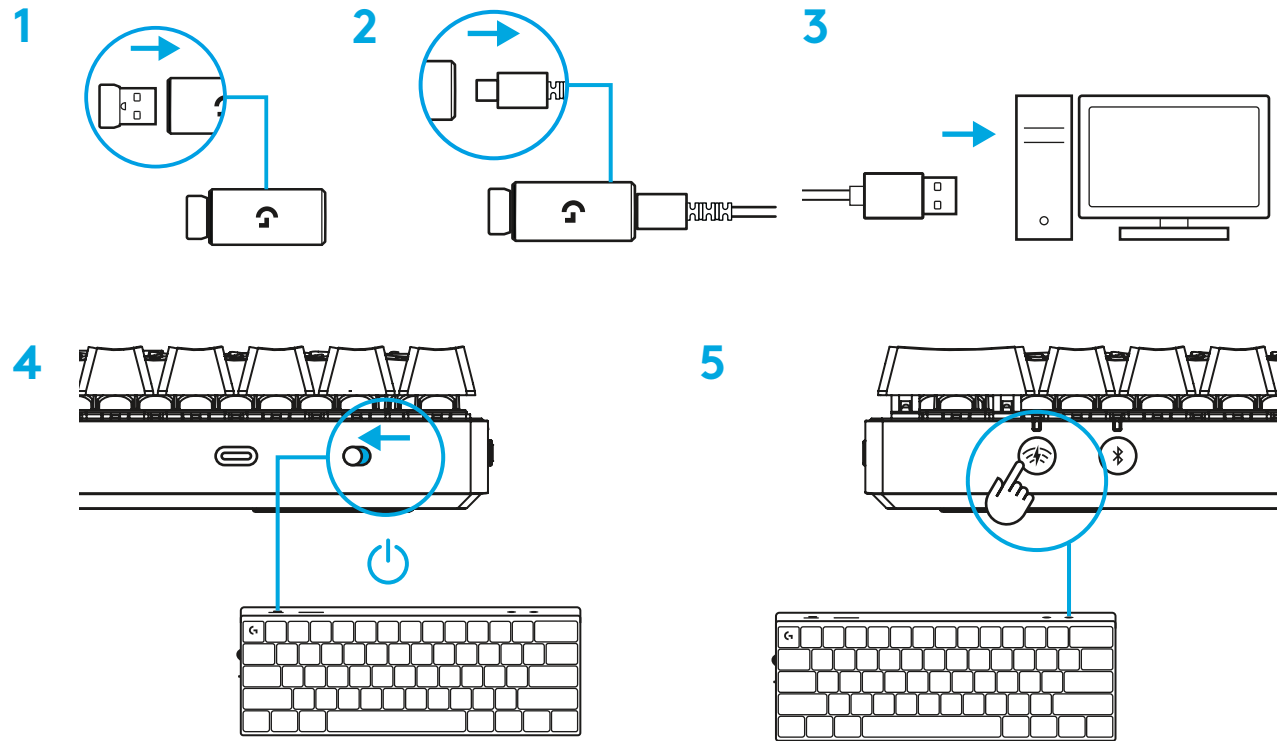

Κατεβάστε και εγκαταστήστε το λογισμικό G HUB στο PC/MAC σας για βέλτιστη εμπειρία παιχνιδιού (το G HUB διαθέτει εισαγωγική παρουσίαση για τις λειτουργίες). Μεταβείτε στη διεύθυνση www.logitechG.com/ghub

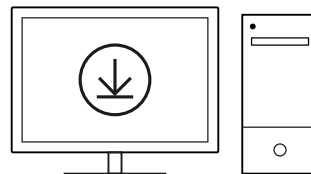

logitechG.com/ghub

ΣΥΝΔΕΣΗ ΜΕ BLUETOOTH®

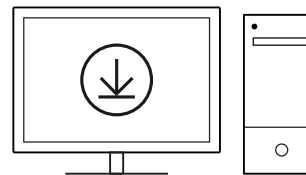
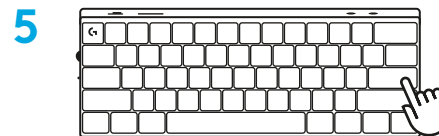
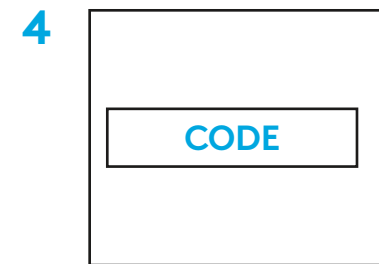
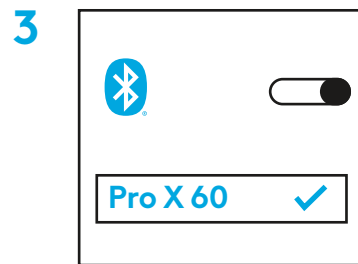
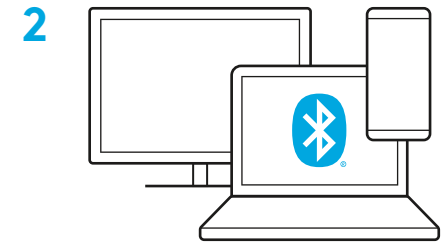
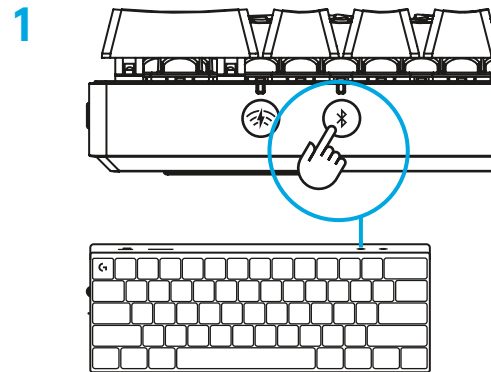

logitechG.com/ghub

Κατεβάστε και εγκαταστήστε το λογισμικό G HUB στο PC/MAC σας για βέλτιστη εμπειρία παιχνιδιού (το G HUB διαθέτει εισαγωγική παρουσίαση για τις λειτουργίες). Μεταβείτε στη διεύθυνση www.logitechG.com/ghub

ΦΟΡΤΙΣΗ ΤΟΥ ΠΛΗΚΤΡΟΛΟΓΙΟΥ

- 1 Εισαγάγετε το καλώδιο *USB-C* στη θύρα στην μπροστινή πλευρά του πληκτρολογίου.

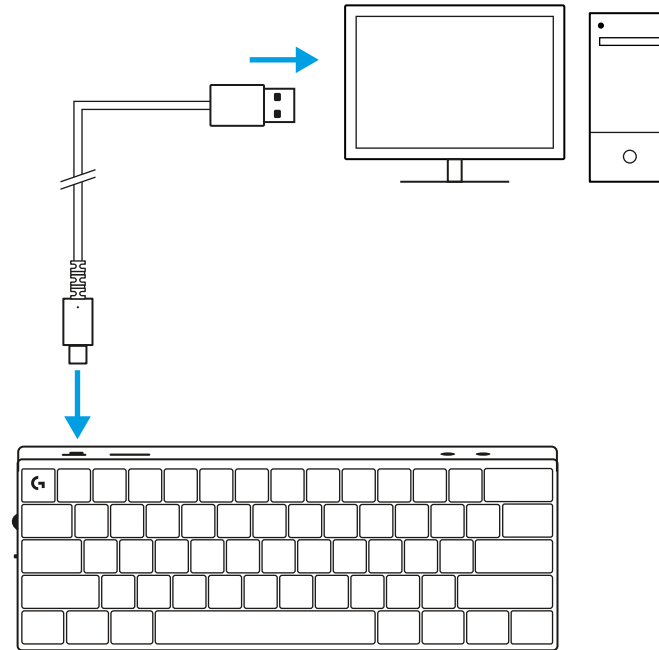

- 2 Συνδέστε το καλώδιο στο PC σας.
Η ενδεικτική λυχνία για την μπαταρία θα αναβοσβήνει αργά με πράσινο χρώμα κατά τη διάρκεια της φόρτισης και θα ανάψει σταθερά με πράσινο χρώμα όταν ολοκληρωθεί η φόρτιση.

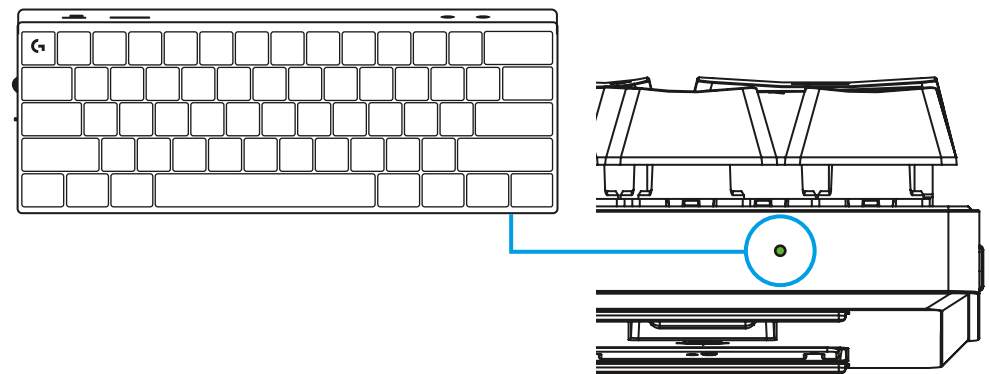

ΛΕΙΤΟΥΡΓΙΑ ΠΑΙΧΝΙΔΙΟΥ





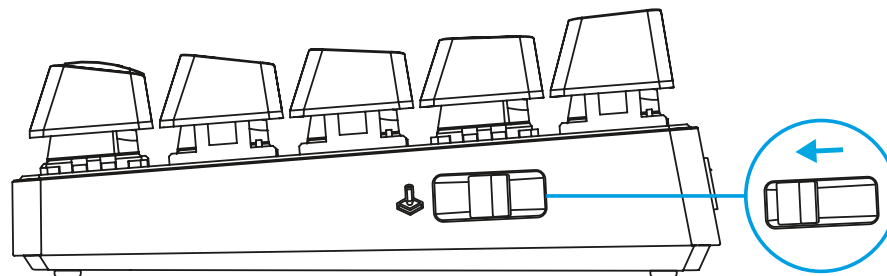

Η ενεργοποίηση της λειτουργίας παιχνιδιού θα απενεργοποιήσει τις λειτουργίες πλήκτρων των Windows προκειμένου να αποφεύγεται η τυχαία ενεργοποίηση.

Μπορείτε επίσης να απενεργοποιείτε διαφορετικά πλήκτρα στις ρυθμίσεις του Ghub.







ΣΥΝΔΥΑΣΜΟΙ ΠΛΗΚΤΡΩΝ





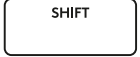

Στοιχεία ελέγχου πολυμέσων

 + 	Αναπαραγωγή/Παύση
 + 	Σίγαση
 + 	Προηγούμενο κομμάτι
 + 	Επόμενο κομμάτι













Πλήκτρα Esc

 + 	`
 +  + 	~



Πλήκτρα βέλους

 + 	Βέλος επάνω
 + 	Βέλος κάτω
 + 	Βέλος δεξιά
 + 	Βέλος αριστερά

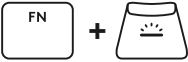
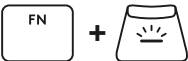
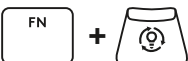

Πλήκτρα λειτουργιών

 + 	Στιγμιότυπο οθόνης
 + 	Αρχική
 + 	Page up
 + 	Page down
 + 	Scroll Lock
 + 	End
 + 	Insert
 + 	Pause / Break

Στοιχεία ελέγχου φωτισμού

	Μείωση της φωτεινότητας του πληκτρολογίου
	Αύξηση της φωτεινότητας του πληκτρολογίου
	Εναλλαγή εφέ κίνησης
	Εναλλαγή παραμέτρων κίνησης

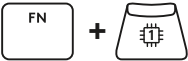
Εναλλαγή προφίλ

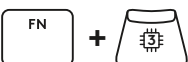
  	Ενεργοποιήστε ένα από τα τρία ενσωματωμένα προφίλ μνήμης
-------------------------------------------------------------------------------------------------------------------------------------------------------------------------------------------------------------------------------------------------------------------	----------------------------------------------------------

Ενεργοποίηση/Απενεργοποίηση πλήρους προσαρμογής πλήκτρων

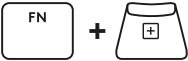
	Ενεργοποίηση πλήρους προσαρμογής πλήκτρων
	Εναλλαγή για επιλογή μεταξύ προεπιλεγμένης και προσαρμοσμένης διάταξης

ОБЗОР ПРОДУКТА

Вид сверху

- 1 Переключатель питания
- 2 Порт Type-C
- 3 Кнопка *BLUETOOTH*[®]
- 4 Кнопка *LIGHTSPEED*
- 5 Переключатель игрового режима
- 6 Индикатор питания
- 7 Регулятор громкости
- 8 Индикатор Caps Lock



Вид снизу

- 1 Отсек для хранения адаптера
- 2 Ножки для наклона

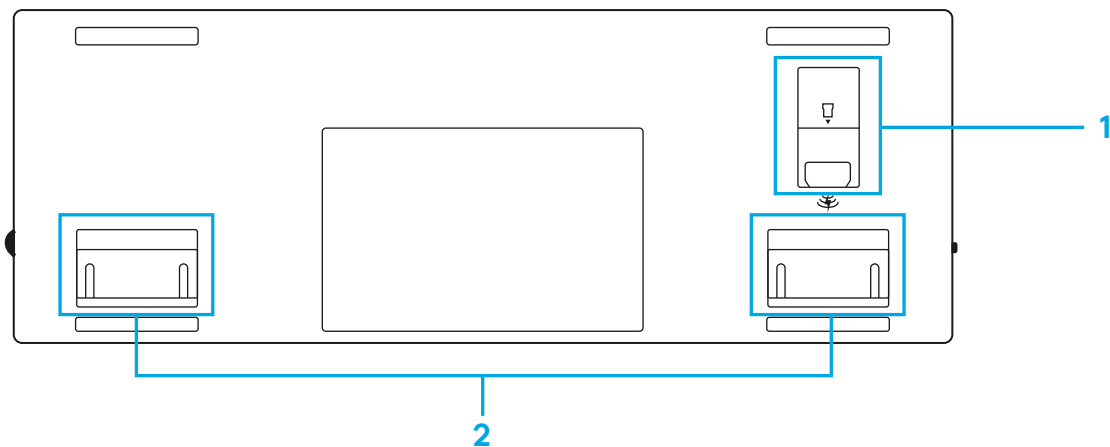

ПОДКЛЮЧЕНИЕ ПО ТЕХНОЛОГИИ LIGHTSPEED

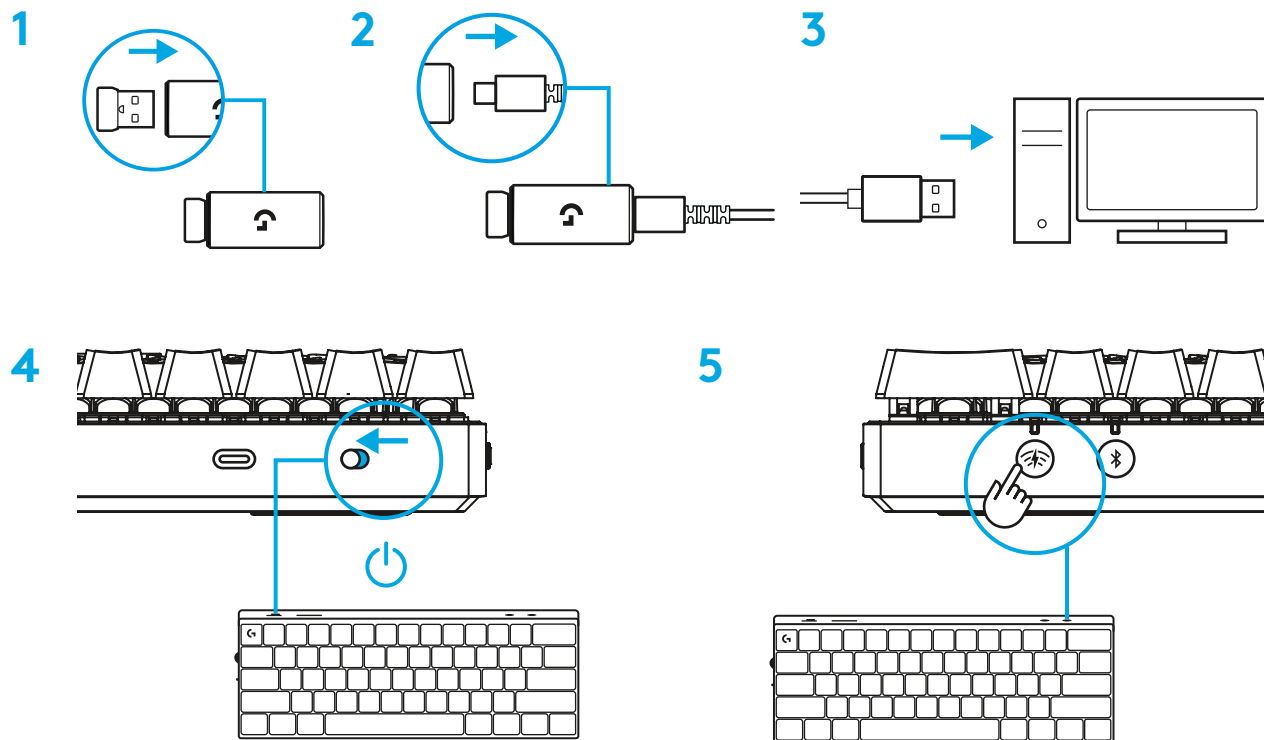

Для незабываемых впечатлений от игры загрузите и установите на своем ПК/МАС ПО G HUB (у G HUB имеются ознакомительные инструкции по подготовке к работе).
Перейдите на страницу www.logitechG.com/ghub

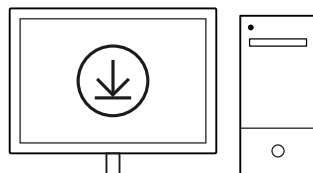

logitechG.com/ghub

ПОДКЛЮЧЕНИЕ ПО BLUETOOTH®

1

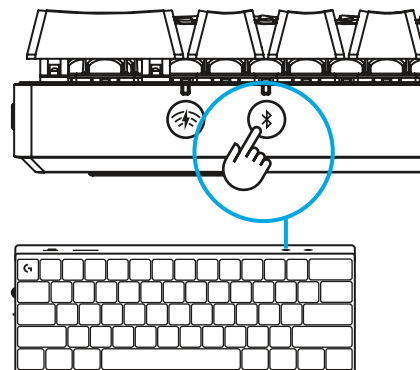

2

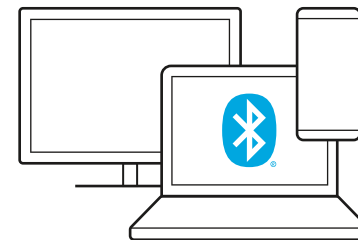

3

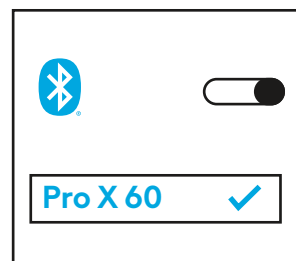

4

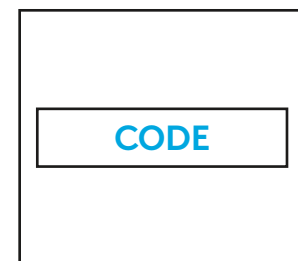

5

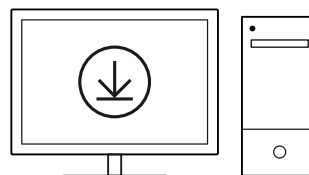
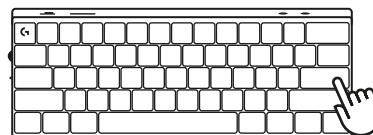

logitechG.com/ghub

Для незабываемых впечатлений от игры загрузите и установите на своем ПК/MAC ПО G HUB (у G HUB имеются ознакомительные инструкции по подготовке к работе).

Перейдите на страницу www.logitechG.com/ghub

ЗАРЯДКА КЛАВИАТУРЫ

- 1 Вставьте кабель *USB-C* в порт, который находится в передней части клавиатуры.

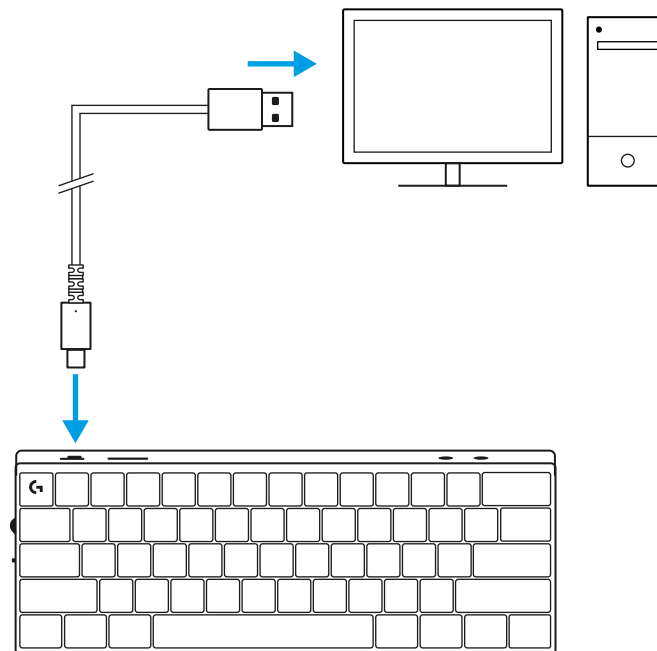

- 2 Подсоедините кабель к своему ПК.
Во время зарядки индикатор состояния батареи будет мигать зеленым цветом, а при полном заряде останется гореть непрерывно.

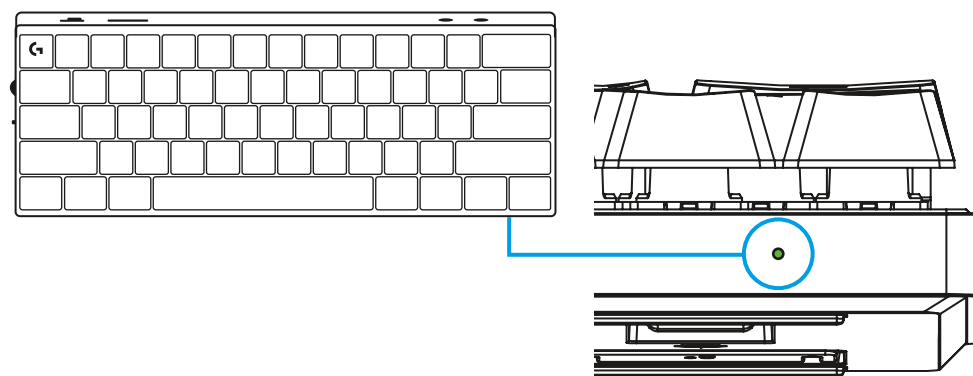

ИГРОВОЙ РЕЖИМ

После включения игрового режима функции клавиши Windows будут отключены, чтобы избежать случайного срабатывания.

Другие клавиши можно отключить в настройках G HUB.

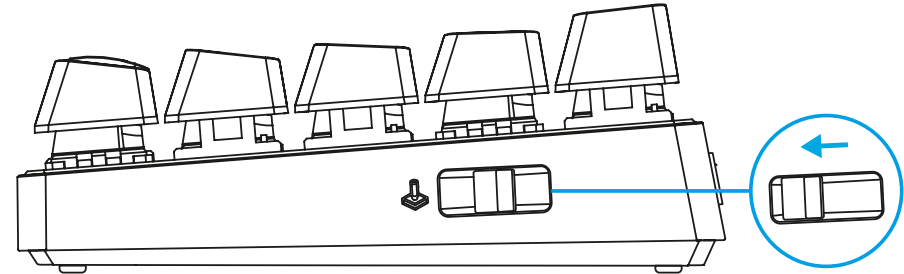





СОЧЕТАНИЯ КЛАВИШ





Элементы управления мультимедиа

 + 	Воспроизведение/ пауза
 + 	Отключение звука
 + 	Предыдущая дорожка
 + 	Следующая дорожка















Клавиши ESC

 + 	~
 +  + 	~

Клавиши со стрелками

 + 	Стрелка вверх
 + 	Стрелка вниз
 + 	Стрелка вправо
 + 	Стрелка влево



Функциональные клавиши

 + 	Снимок экрана
 + 	Home
 + 	Клавиша Page Up
 + 	Клавиша Page Down
 + 	Клавиша Scroll Lock
 + 	Клавиша End
 + 	Клавиша Insert
 + 	Клавиша Pause/Break

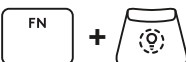
Управление подсветкой

	Уменьшить яркость подсветки клавиатуры
	Увеличить яркость подсветки клавиатуры
	Переключение между эффектами анимации
	Переключение между параметрами анимации

Переключение профилей

  	Активация одного из трех профилей встроенной памяти
-------------------------------------------------------------------------------------------------------------------------------------------------------------------------------------------------------------------------------------------------------------------	-----------------------------------------------------

Включение и отключение полной настройки клавиш

	Включение полной настройки клавиш
	Переключение между раскладкой по умолчанию и настраиваемой раскладкой

PRZEGLĄD PRODUKTU

Widok z góry

- 1 Przełącznik zasilania
- 2 Port typu C
- 3 Przycisk *BLUETOOTH*[®]
- 4 Przycisk *LIGHTSPEED*
- 5 Przełącznik trybu gry
- 6 Kontrolka zasilania
- 7 Rolka głośności
- 8 Wskaźnik Caps Lock



Spód urządzenia

- 1 Miejsce na klucz sprzętowy
- 2 Odchylane nóżki

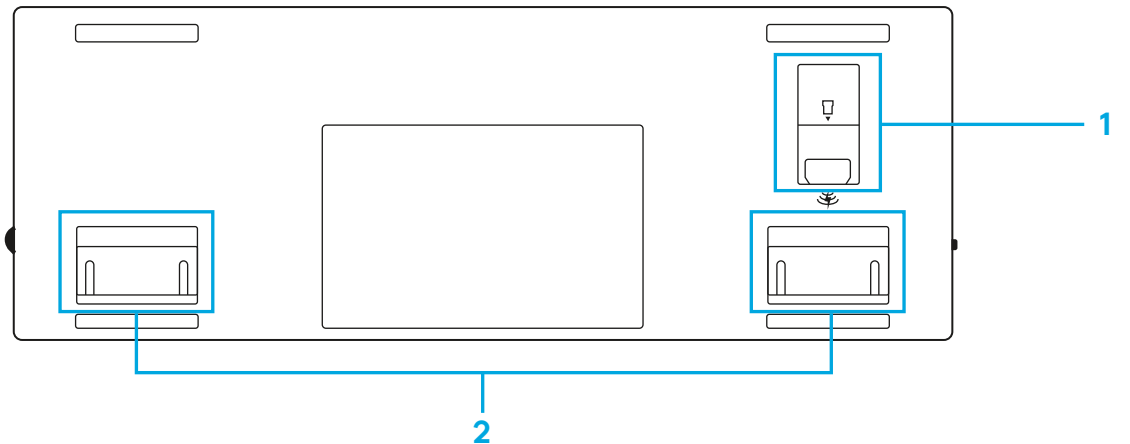

POŁĄCZENIE LIGHTSPEED

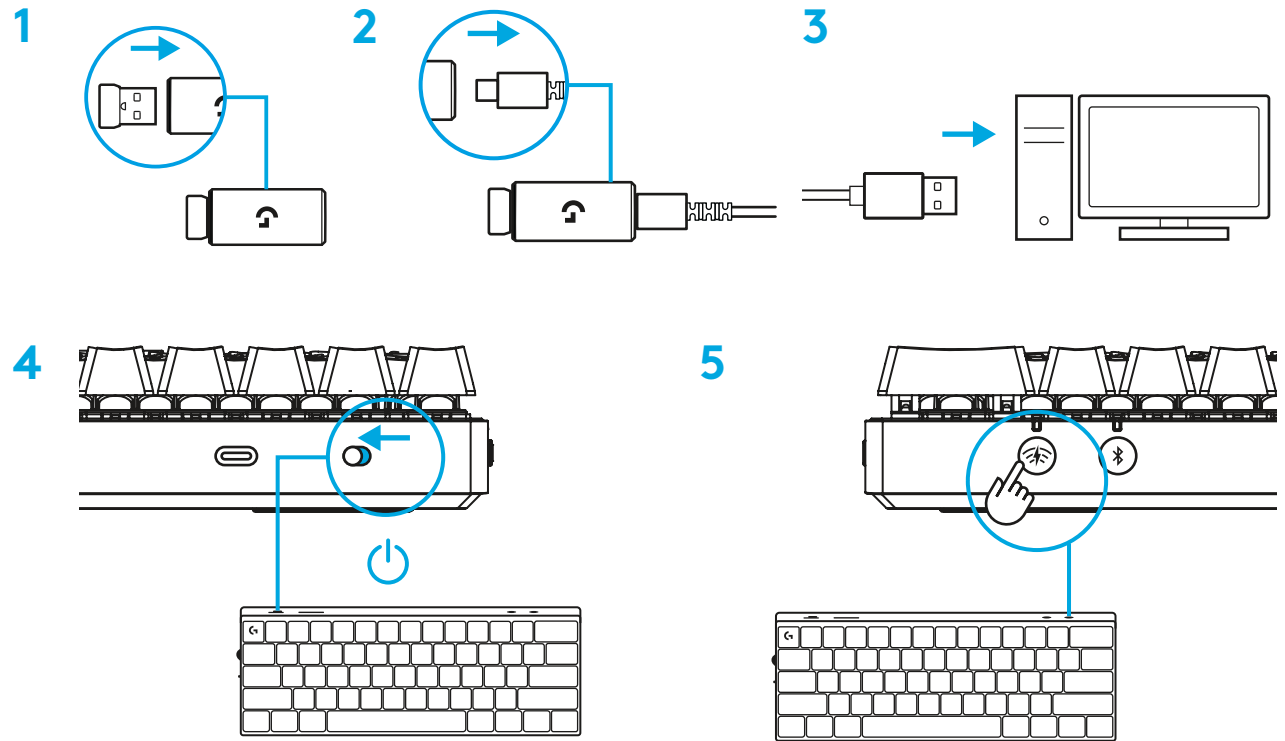

Pobierz i zainstaluj na swoim komputerze PC lub MAC oprogramowanie G HUB, aby zapewnić sobie najlepsze wrażenia gamingowe (G HUB oferuje instrukcje wprowadzające dla funkcji).
Przejdź do www.logitechG.com/ghub

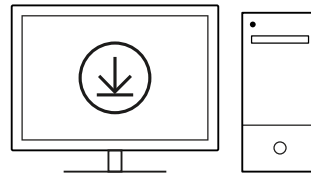

logitechG.com/ghub

POŁĄCZENIE BLUETOOTH®

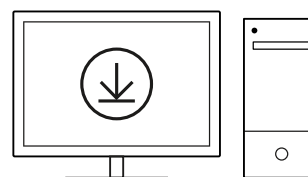
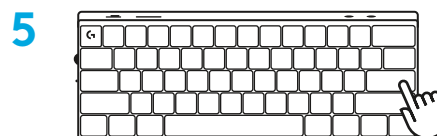
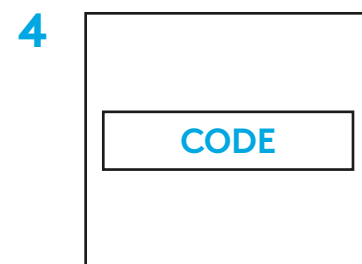
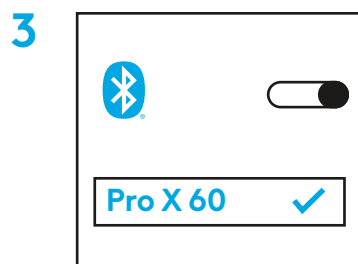
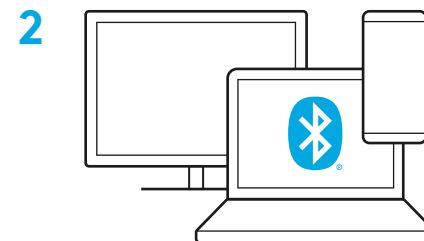
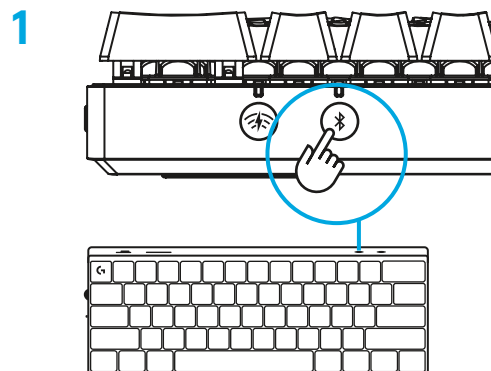

logitechG.com/ghub

Pobierz i zainstaluj na swoim komputerze PC lub MAC oprogramowanie G HUB, aby zapewnić sobie najlepsze wrażenia gamingowe (G HUB oferuje instrukcje wprowadzające dla funkcji).
Przejdź do www.logitechG.com/ghub

ŁADOWANIE KLAWIATURY

1 Włóż kabel *USB-C* do portu z przodu klawiatury.

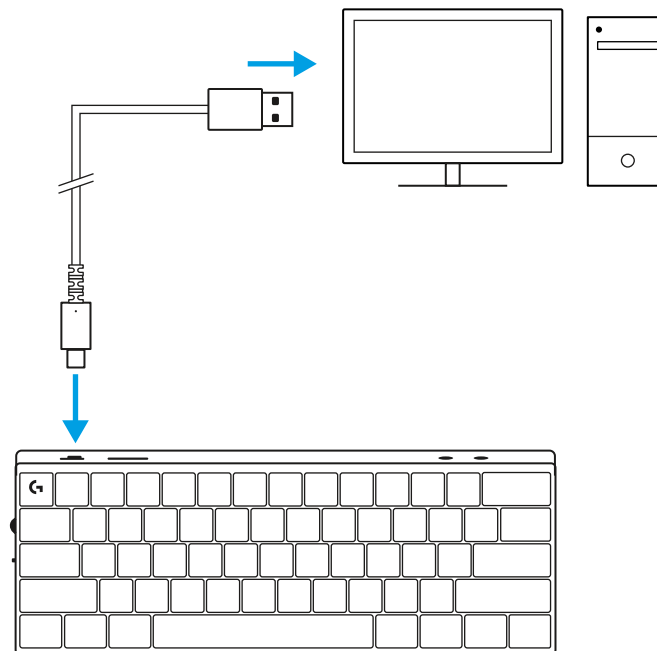

2 Podłącz kabel do komputera.
Kontrolka baterii będzie pulsować na zielono podczas ładowania oraz zaświeci się stałym zielonym światłem po pełnym naładowaniu.

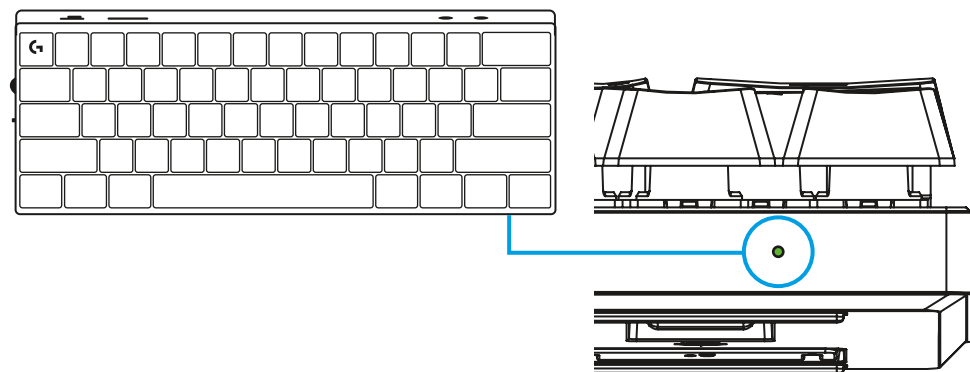

TRYB GRY





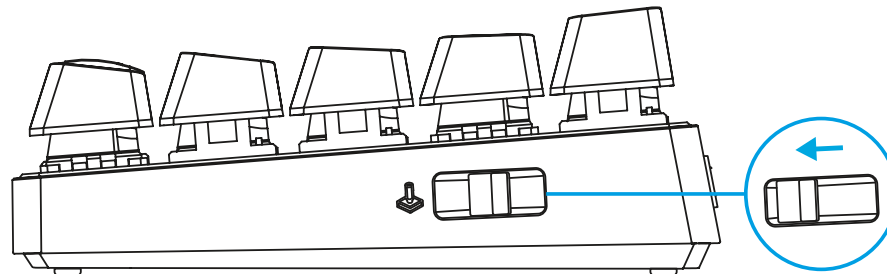



Włączenie Trybu gry zablokuje funkcje przycisku Windows, aby zapobiec ich przypadkowemu włączeniu.

Można również zablokować inne przyciski w ustawieniach Ghub.







KOMBINACJE PRZYCISKÓW

Sterowanie multimediami

 + 	Odtwarzaj/wstrzymaj
 + 	Wycisz
 + 	Poprzedni utwór
 + 	Następny utwór

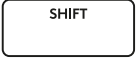
Klawisze ESC

 + 	~
 +  + 	~

Klawisze strzałek

	Strzałka w górę
	Strzałka w dół
	Strzałka w prawo
	Strzałka w lewo

Klawisze funkcyjne

	Zrzut ekranu
	Strona główna
	Page up
	Page down
	Scroll Lock
	End
	Insert
	Pause/Przerwa

Sterowanie podświetleniem

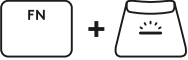
	Zmniejsz jasność klawiatury
	Zwiększ jasność klawiatury
	Przełączanie między efektami animacji
	Przełączanie między parametrami animacji

Przełączanie profili

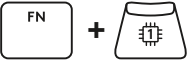
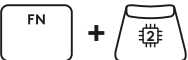
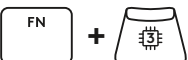
	Aktywacja jednego z trzech profili pamięci wbudowanej
	
	

Pełna personalizacja klawiszy włączona/wyłączona

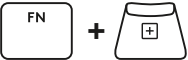
	Włącz pełną personalizację klawiszy
	Przełączanie między układem domyślnym i niestandardowym

TERMÉKISMERTETŐ

Felülnézet

- 1 Bekapcsoló
- 2 Type C-port
- 3 **BLUETOOTH®** gomb
- 4 LIGHTSPEED gomb
- 5 Játék üzemmód kapcsolója
- 6 Tápellátás jelzőfénye
- 7 Hangerő-szabályozó görgő
- 8 Caps Lock jelzőfénye



Alulnézet

- 1 Bedugható tároló
- 2 Állítható lábak

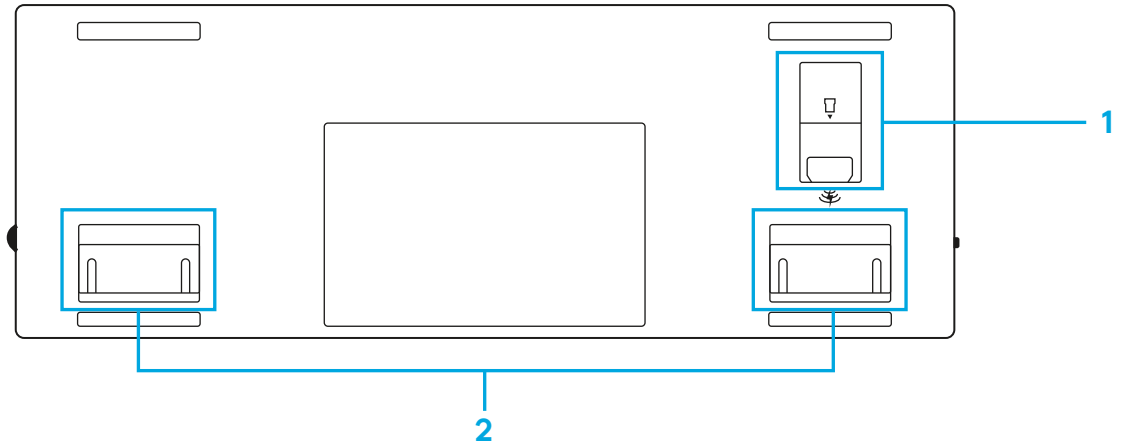

LIGHTSPEED-KAPCSOLAT

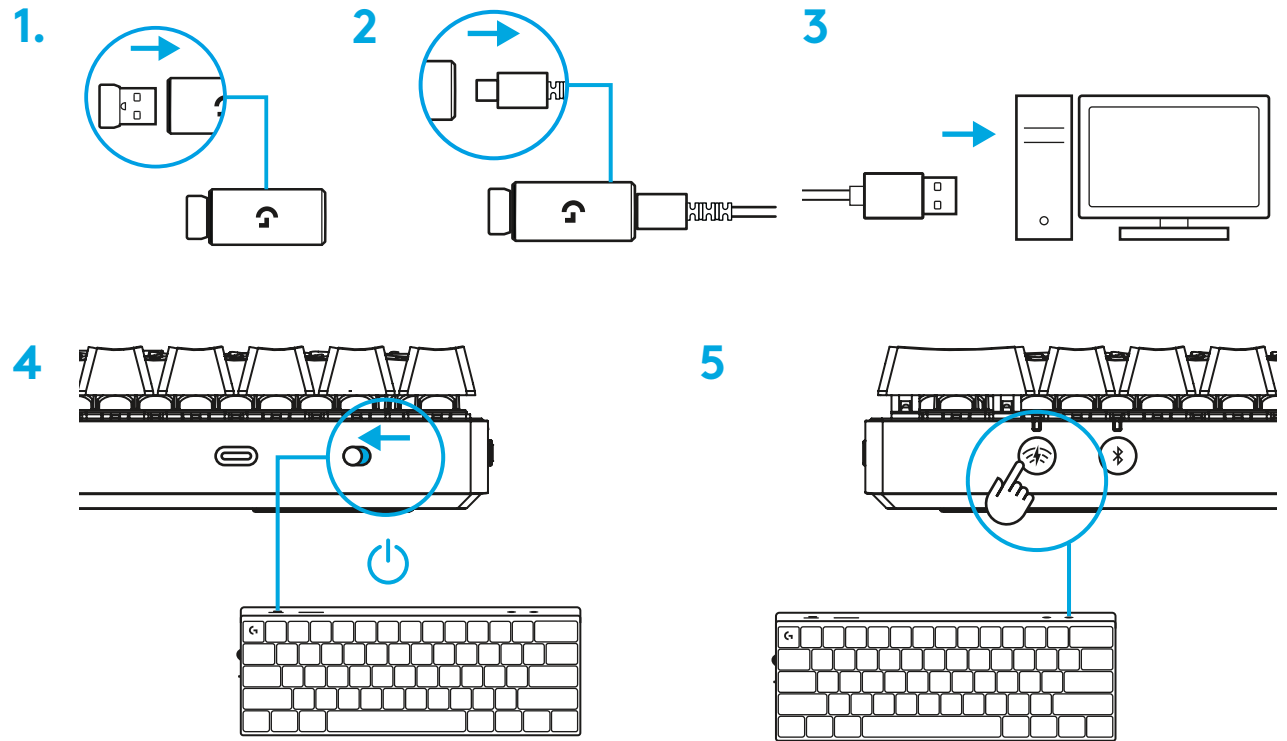

Töltse le és telepítse a G HUB szoftvert PC/ MAC számítógépére a tökéletes játékelmény érdekében (a G HUB beépített memóriával rendelkezik a funkciókhoz).
Keresse fel a <https://www.logitechg.com/ghub> weboldalt

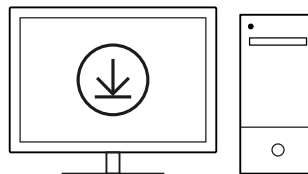

[logitechG.com/ghub](https://www.logitechg.com/ghub)

BLUETOOTH®-KAPCSOLAT

1.

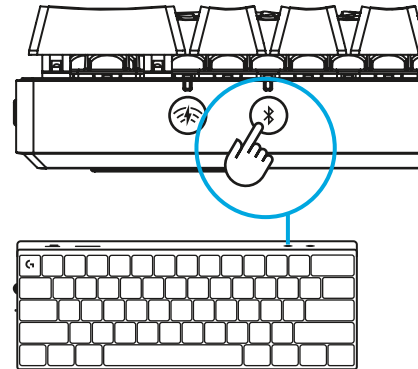

2.

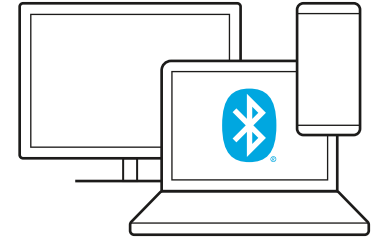

3.

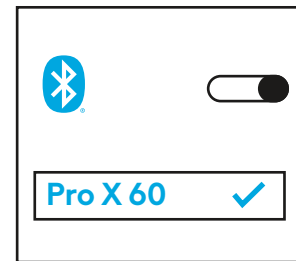

4.

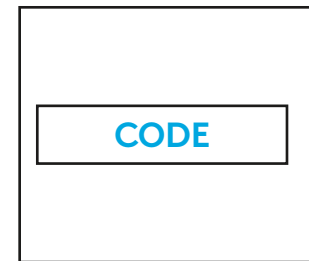

5.

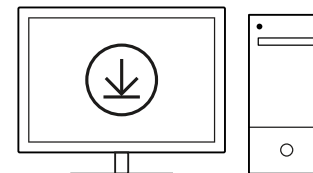
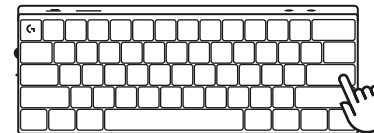

Töltse le és telepítse a G HUB szoftvert PC/MAC számítógépére a tökéletes játékelmény érdekében (a G HUB beépített memóriával rendelkezik a funkciókhoz). Keresse fel a <https://www.logitechg.com/ghub> weboldalt

[logitechG.com/ghub](https://www.logitechg.com/ghub)

A BILLENTYŰZET TÖLTÉSE

- 1 Dugja be az *USB-C*-kábelt a billentyűzet elején található portba.

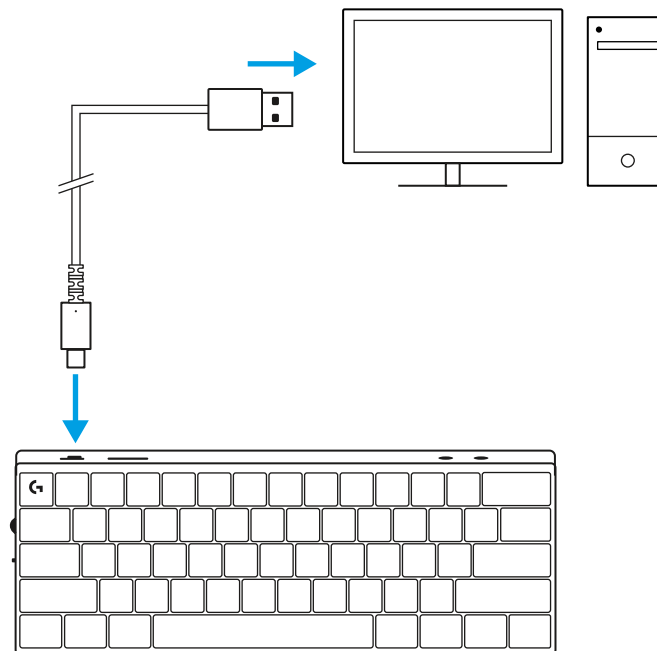

- 2 Csatlakoztassa az *USB*-kábelt a *PC*-jéhez.
A töltétségjelző fény töltés közben zöld színben pulzál, és ha eléri a teljes töltöttséget, folyamatos zöld színnel világít.

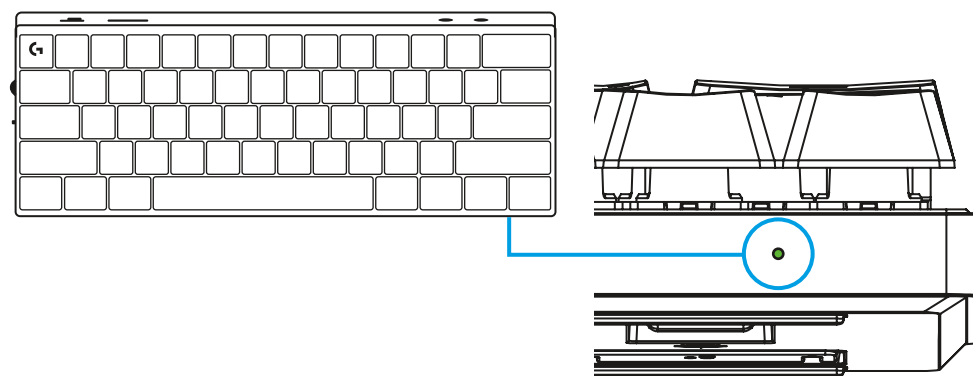

JÁTÉK ÜZEMMÓD

A Játékmód bekapcsolása letiltja a Windows billentyűfunkciókat a véletlen tüzelés elkerülése érdekében.

A GHUB beállításában is letilthat különböző billentyűket.

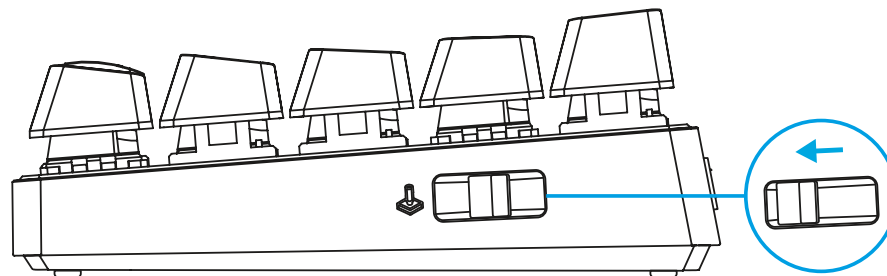



BILLENTYŰKOMBINÁCIÓK

Médiavezérlők

FN + 	Lejátszás/Szünet
FN + 	Némítás
FN + 	Előző elem
FN + 	Következő elem

Esc billentyűk

FN + 	`
FN + SHIFT + 	~









Nyílbillentyűk

	Felfelé nyíl
	Lefelé nyíl
	Jobb nyíl
	Bal nyíl







Funkcióbillentyűk

	Screenshot
	Home
	Lapozás felfelé
	Lapozás lefelé
	Scroll Lock
	End
	Insert
	Pause/Break



Megvilágításvezérlő

 + 	Csökkenti a billentyűzet fényerejét
 + 	Növeli a billentyűzet fényerejét
 + 	Animációs effektek léptetése
 + 	Animációs paraméterek léptetése

Profilkapcsolók

 +   +   + 	A három beépített memóriaprofil egyikének aktiválása
-------------------------------------------------------------------------------------------------------------------------------------------------------------------------------------------------------------------------------------------------------------------------------------------------------------------------------------------------------------------------------------------------------------------------------------------------------------------------------------------------------------------------------------	------------------------------------------------------

Teljes billentyű-testreszabás be/ki

 + 	Teljes billentyű-testreszabás engedélyezése
	Váltás az alapértelmezett és testre szabott elrendezés között

نمای بالا

- 1 کلید روشن/خاموش
- 2 درگاه نوع C
- 3 دکمه **BLUETOOTH**[®]
- 4 دکمه **LIGHTSPEED**
- 5 دکمه «حالت بازی»
- 6 نشانگر روشن/خاموش
- 7 غلتک میزان صدا
- 8 نشانگر Caps Lock

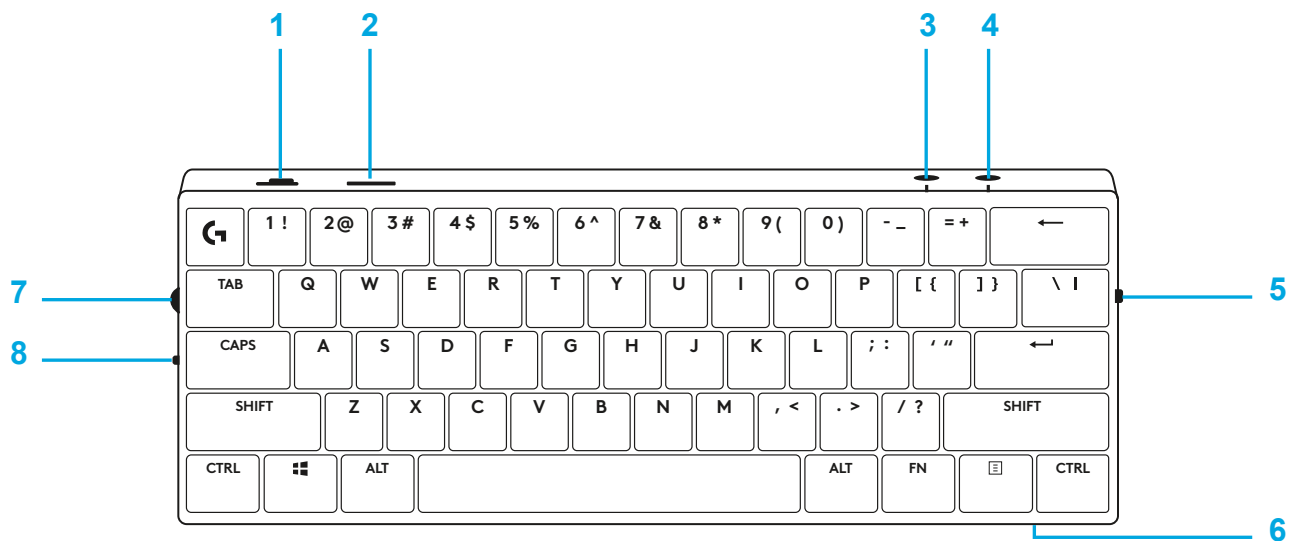

نمای پایین

- 1 محل ذخیره سازی قفل سخت افزاری
- 2 پایه های عمودی

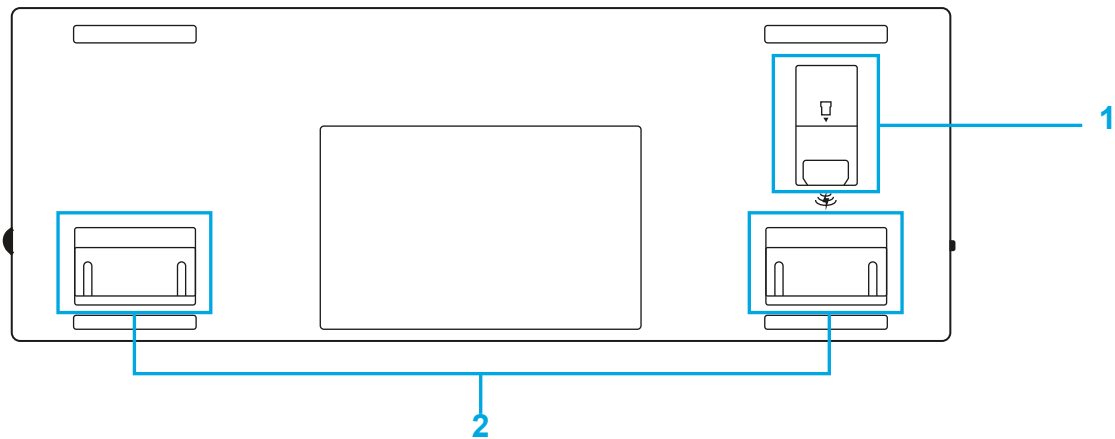

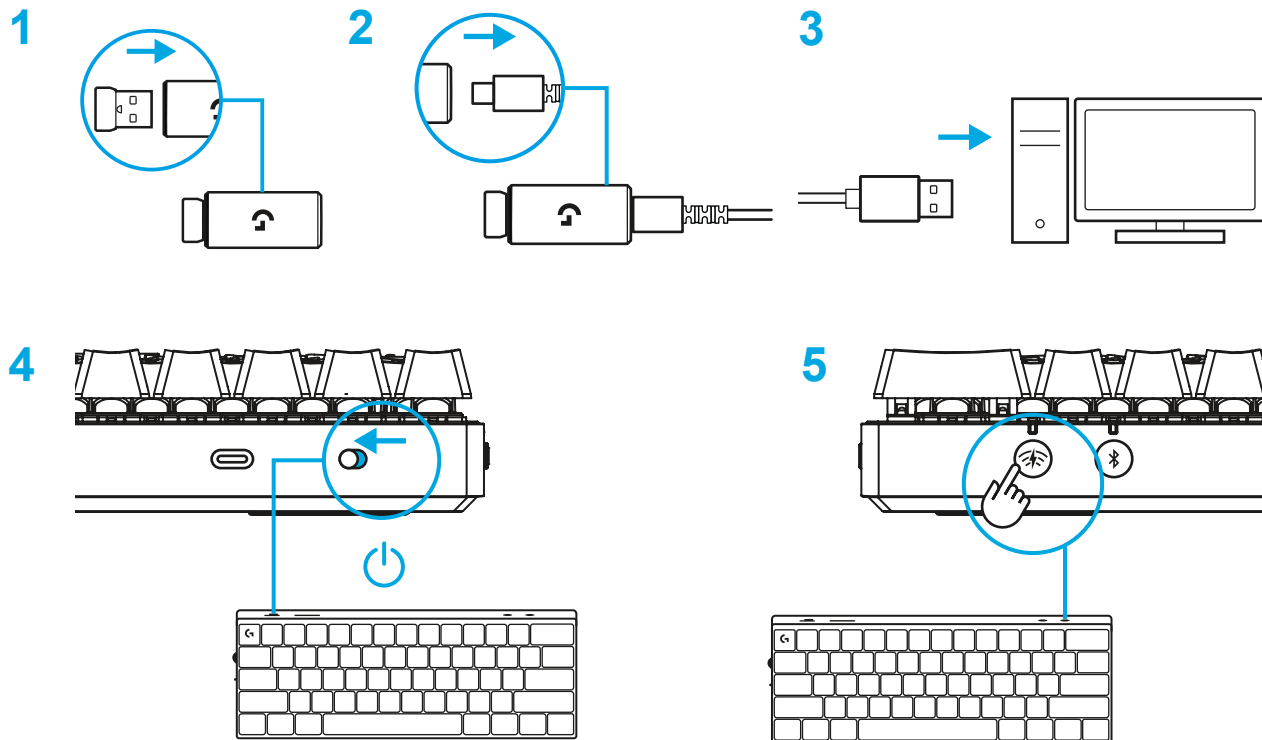

برای بهترین تجربه بازی، نرم افزار G HUB را در رایانه/
MAC بارگیری و نصب کنید (G HUB یک داستان
آماده سازی برای ویژگی ها دارد).
به www.logitechG.com/ghub بروید

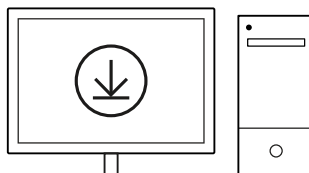

logitechG.com/ghub

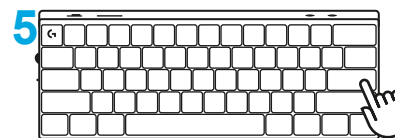
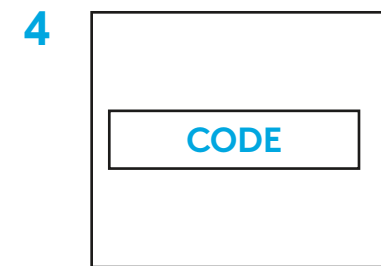
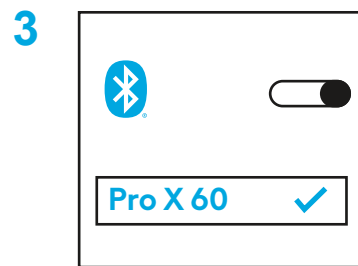
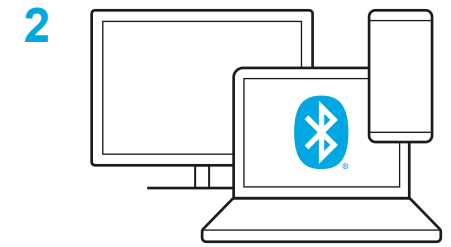
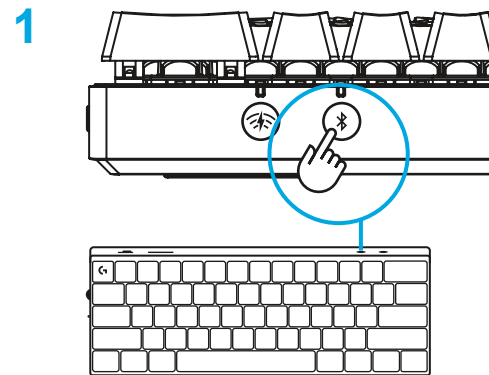

برای بهترین تجربه بازی، نرم افزار G HUB را در رایانه/MAC بارگیری و نصب کنید (G HUB یک داستان آماده سازی برای ویژگی ها دارد).
به www.logitechG.com/ghub بروید

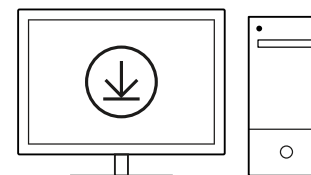

logitechG.com/ghub

1 کابل **USB-C** را در درگاه جلوی صفحه کلید وارد کنید.

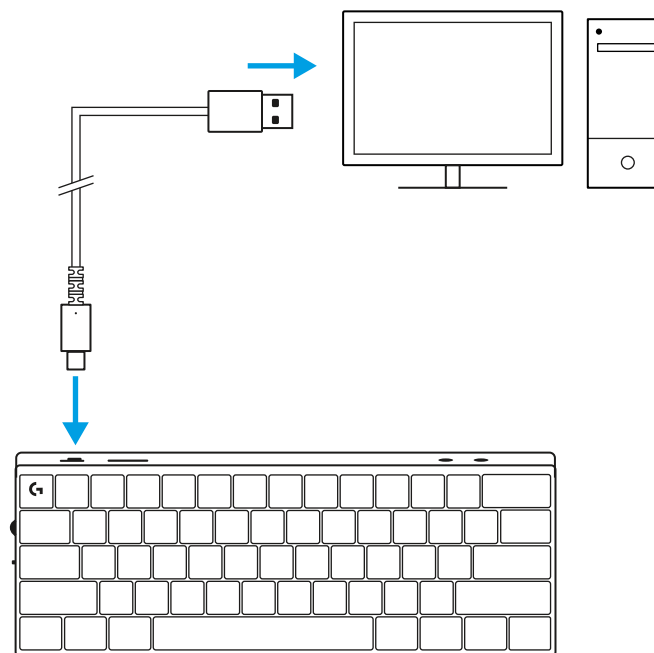

2 کابل را به رایانه متصل کنید.
درحین شارژ چراغ نشانگر باتری به رنگ سبز چشمک خواهد زد و وقتی شارژ کامل شد به رنگ سبز ثابت می‌شود.

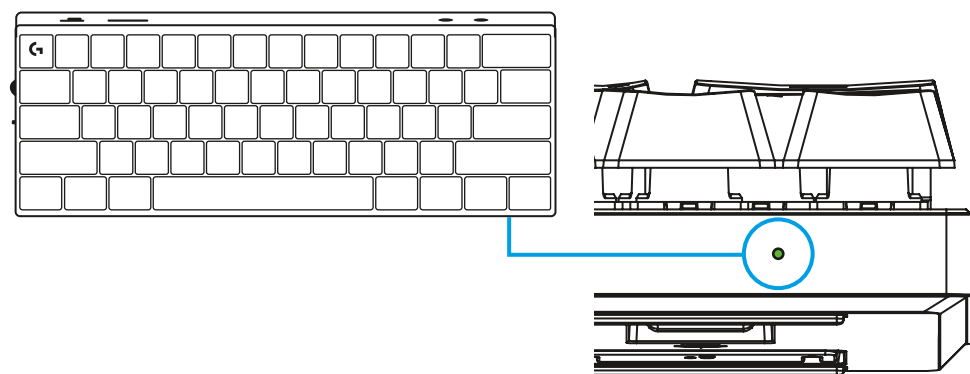

حالت بازی

روشن کردن «حالت بازی» قابلیت‌های کلید Windows را غیرفعال می‌کند تا از راه‌اندازی تصادفی اجتناب شود.

همچنین می‌توانید کلیدهای مختلف را در تنظیمات Ghub غیرفعال کنید.

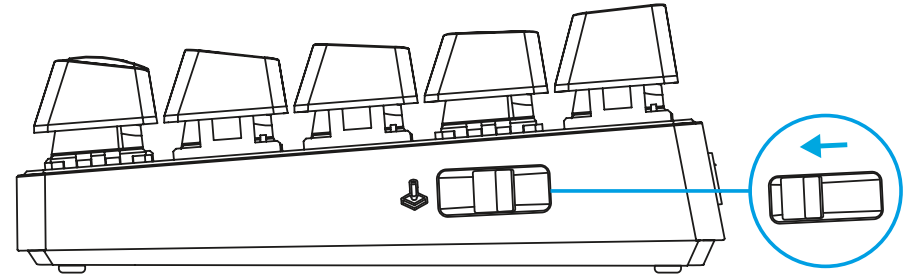

ترکیبات کلید

کنترل‌های رسانه

پخش/توقف موقت	FN +
بی‌صدا کردن	FN +
آهنگ قبلی	FN +
آهنگ بعدی	FN +

کلیدهای ESC

,	FN +
~	FN + SHIFT +

کلیدهای پیکان

پیکان بالا	 + 
پیکان پایین	 + 
پیکان راست	 + 
پیکان چپ	 + 







کلیدهای عملکردی

عکس صفحه‌نمایش	 + 
خانه	 + 
صفحه بالا بر	 + 
صفحه پایین بر	 + 
قفل پیمایش	 + 
پایان	 + 
درج	 + 
توقف موقت / استراحت	 + 



کنترل روشنایی

کاهش روشنایی صفحه کلید	 + 
افزایش روشنایی صفحه کلید	 + 
جابجایی در جلوه پویانمایی	 + 
جابجایی در پارامترهای پویانمایی	 + 

کلیدهای نمایه

فعال‌سازی یکی از سه نمایه حافظه داخلی	 + 
	 + 
	 + 

روشن/خاموش کردن سفارشی‌سازی Full Key

فعال کردن سفارشی‌سازی Full Key	 + 
تغییر وضعیت برای جابجایی بین چیدمان پیش‌فرض و سفارشی‌سازی‌شده	

PŘEHLED PRODUKTU

Pohled shora

- 1 Vypínač
- 2 Port Typ-C
- 3 Tlačítko *BLUETOOTH*[®]
- 4 Tlačítko *LIGHTSPEED*
- 5 Přepínač herního režimu
- 6 Indikátor napájení
- 7 Otočný ovladač hlasitosti
- 8 Indikátor klávesy Caps lock

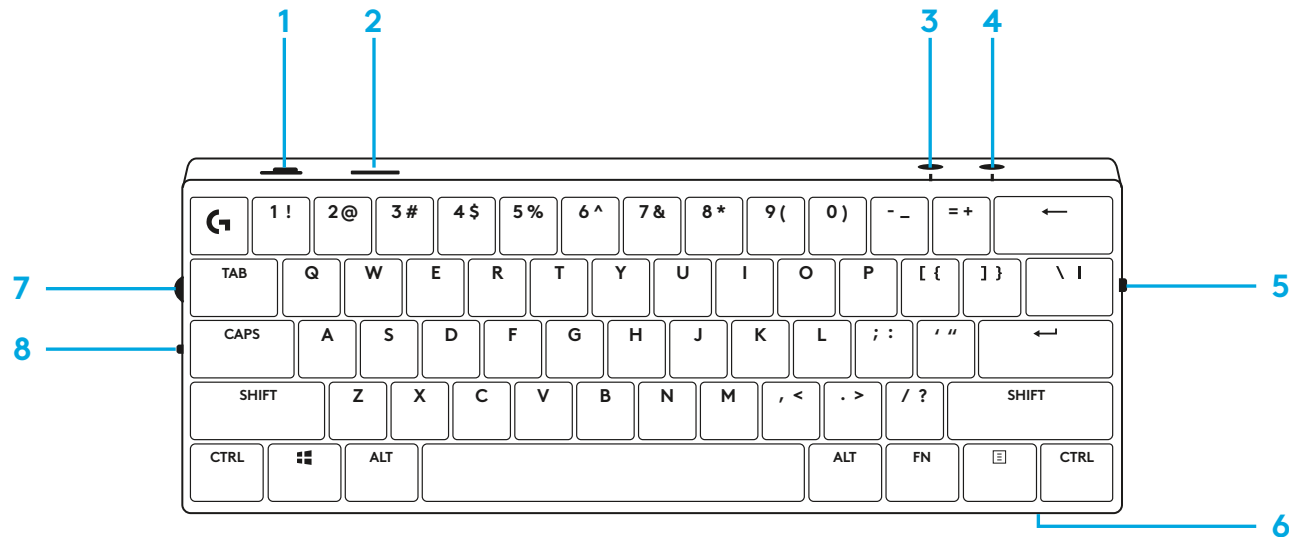

Pohled zdola

- 1 Úložný prostor pro adaptér
- 2 Sklopné nožky

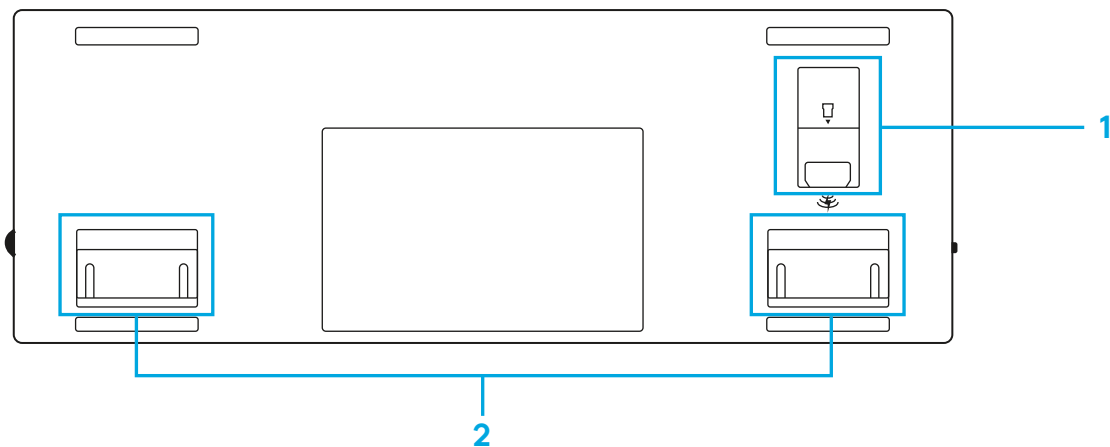

PŘIPOJENÍ LIGHTSPEED

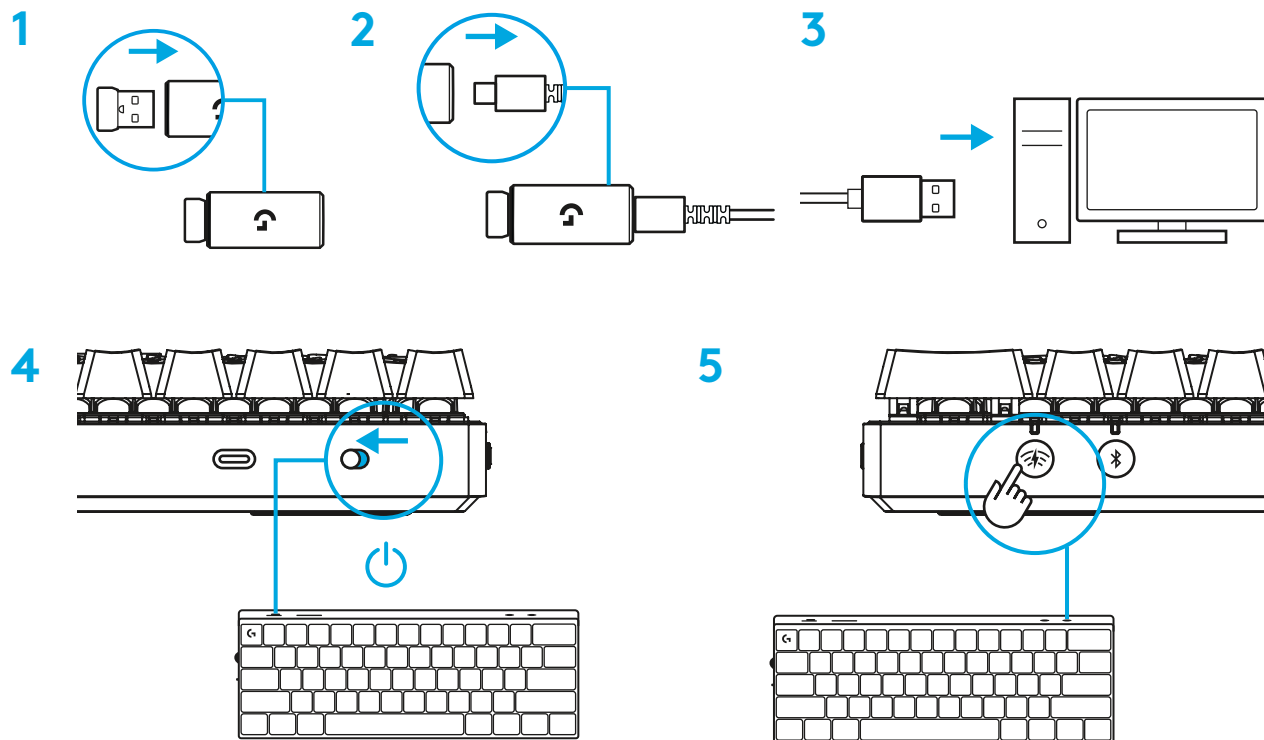

Stáhněte si a nainstalujte software G HUB do počítače PC/MAC, abyste dosáhli co nejlepšího herního zážitku (G HUB zahrnuje článek pro seznámení s funkcemi).
Přejděte na stránku www.logitechG.com/ghub

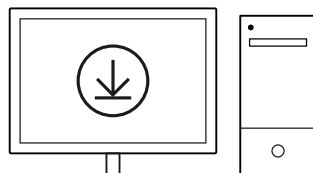

logitechG.com/ghub

PŘIPOJENÍ BLUETOOTH®

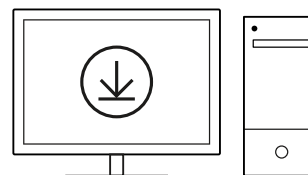
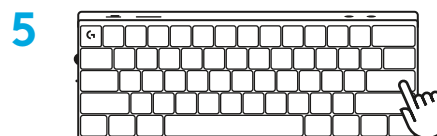
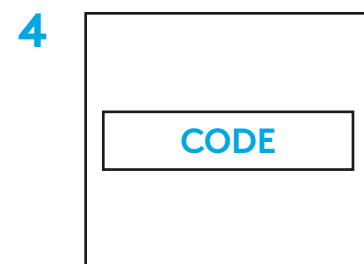
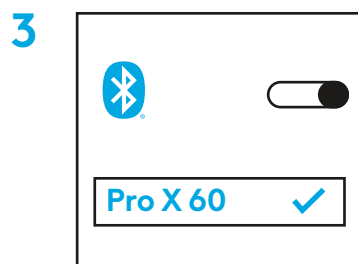
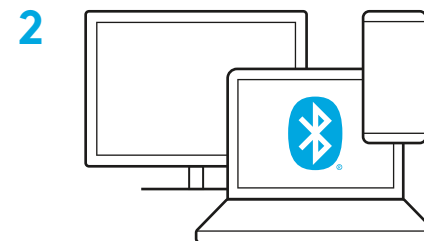
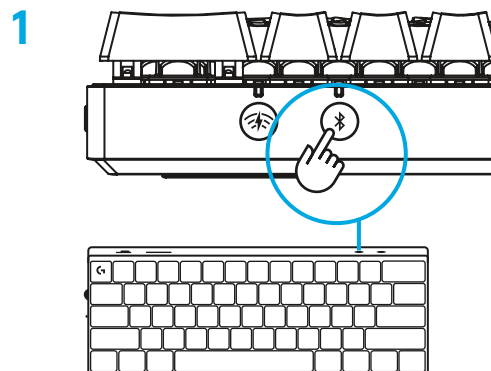

[logitechG.com/ghub](https://www.logitechG.com/ghub)

Stáhněte si a nainstalujte software G HUB do počítače PC/MAC, abyste dosáhli co nejlepšího herního zážitku (G HUB zahrnuje článek pro seznámení s funkcemi).
Přejděte na stránku www.logitechG.com/ghub

NABÍJENÍ KLÁVESNICE

1 Zastrčte kabel *USB-C* do portu v přední části klávesnice.

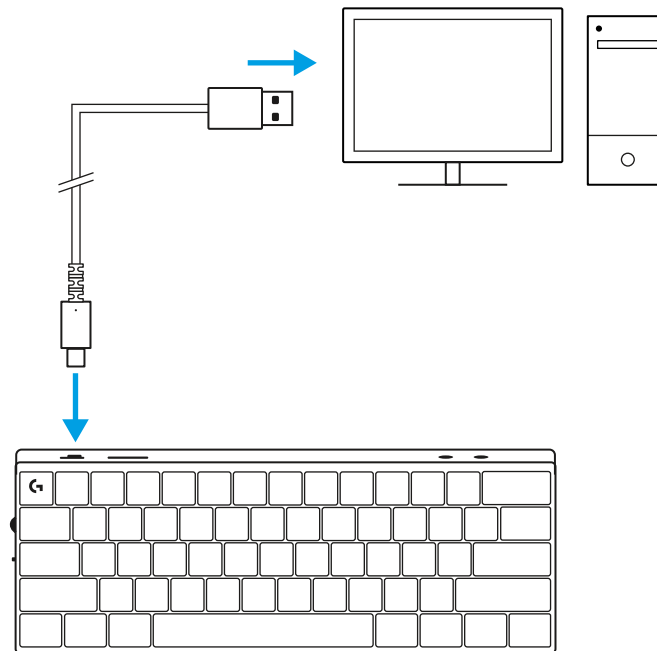

2 Připojte kabel k počítači PC.
Indikátor baterie bude během nabíjení pulzovat zeleně
a po úplném nabití se rozsvítí zeleně.

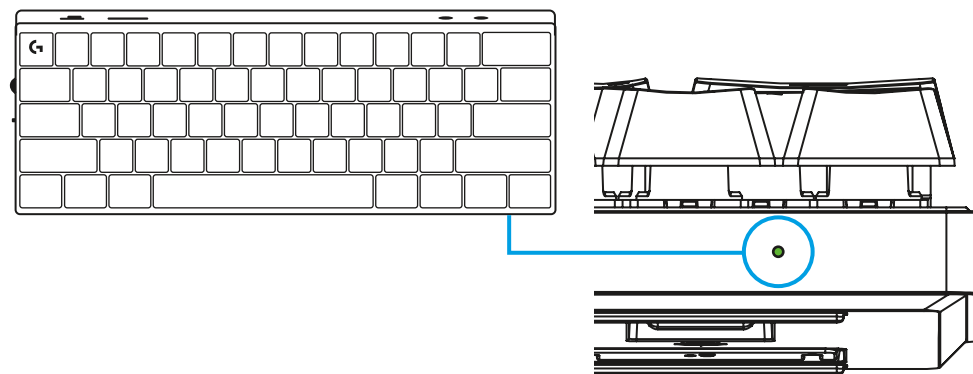

HERNÍ REŽIM



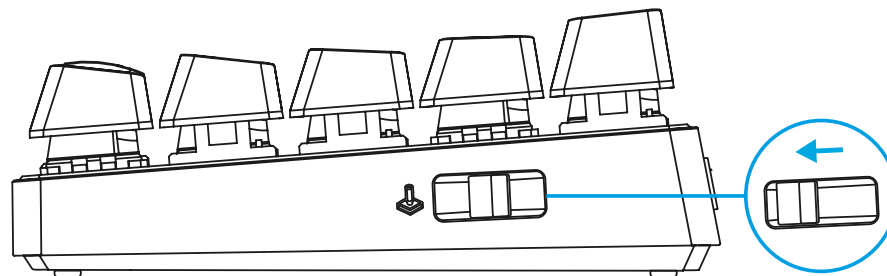

Zapnutí herního režimu deaktivuje funkce kláves Windows s cílem zabránit jejich nechtěnému spuštění.

Různé klávesy můžete deaktivovat také v nastavení Ghub.





KOMBINACE KLÁVES







Ovládací prvky médií

FN + 	Přehrát/.Pozastavit
FN + 	Ztlumit
FN + 	Předchozí stopa
FN + 	Následující stopa



Klávesy Esc

FN + 	`
FN + SHIFT + 	~









Klávesy se šípkami

 + 	Šipka nahoru
 + 	Šipka dolů
 + 	Šipka doprava
 + 	Šipka doleva







Funkční klávesy

 + 	Snímek obrazovky
 + 	Domů
 + 	Page up
 + 	Page down
 + 	Scroll Lock
 + 	End
 + 	Insert
 + 	Pause/Break



Ovládání podsvícení

 + 	Snížení jasu klávesnice
 + 	Zvýšení jasu klávesnice
 + 	Procházení animačními efekty
 + 	Procházení parametry animace

Přepínání profilů

 +   +   + 	Aktivace jednoho ze tří integrovaných paměťových profilů
-------------------------------------------------------------------------------------------------------------------------------------------------------------------------------------------------------------------------------------------------------------------------------------------------------------------------------------------------------------------------------------------------------------------------------------------------------------------------------------------------------------------------------------	----------------------------------------------------------

Úplné přizpůsobení kláves zap/vyp

 + 	Povolit úplné přizpůsobení kláves
	Přepnout mezi výchozím a přizpůsobeným rozvržením

PREHĽAD PRODUKTU

Pohľad zhora

- 1 Vypínač
- 2 Port Typ-C
- 3 Tlačidlo *BLUETOOTH*[®]
- 4 Tlačidlo *LIGHTSPEED*
- 5 Prepínač herného režimu
- 6 Indikátor napájania
- 7 Otočný ovládač hlasitosti
- 8 Indikátor klávesu Caps lock

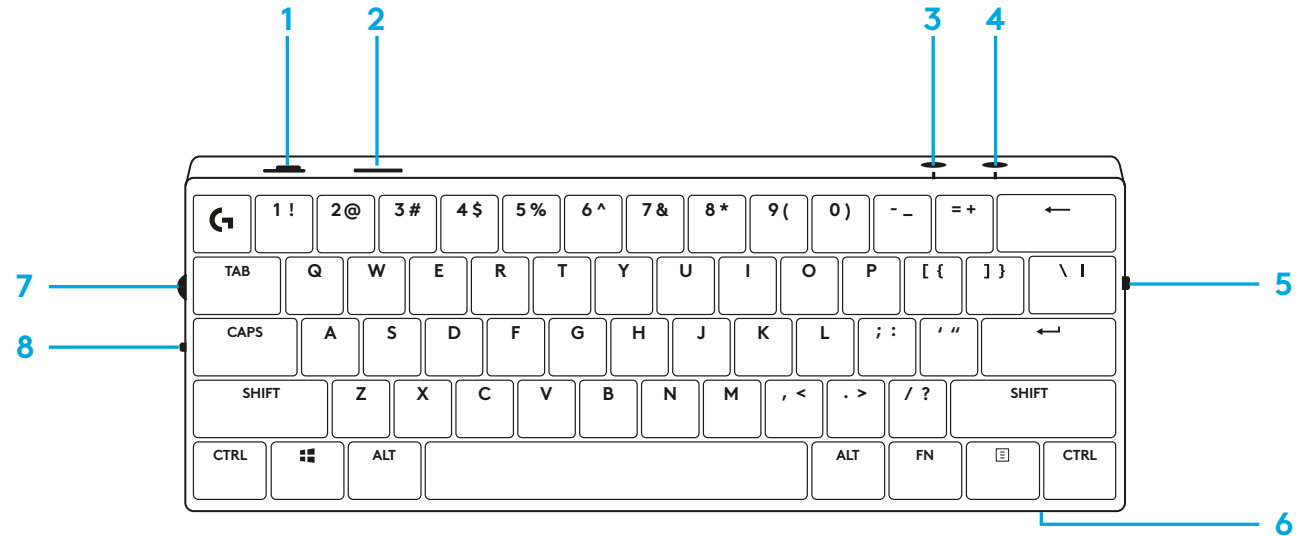

Pohľad zdola

- 1 Úložný priestor pre adaptér
- 2 Sklopné nôžky

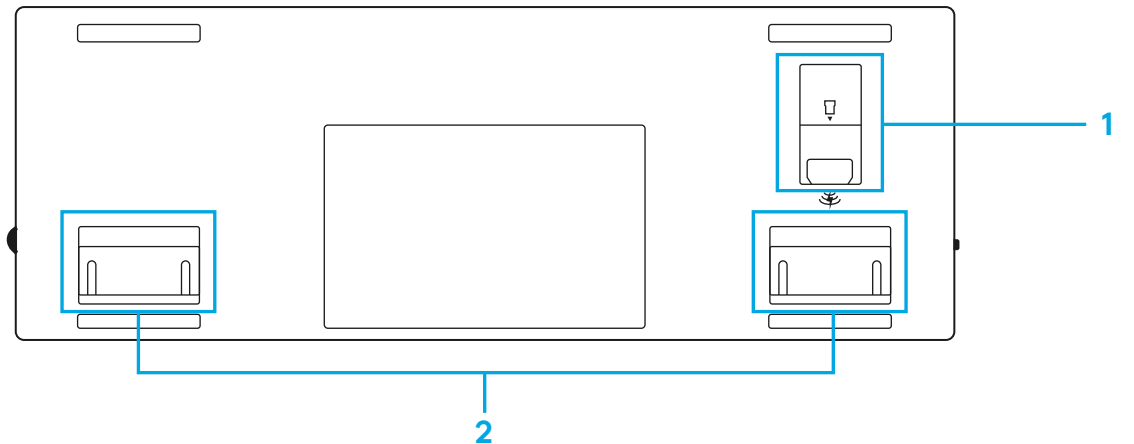

PRIPOJENIE LIGHTSPEED

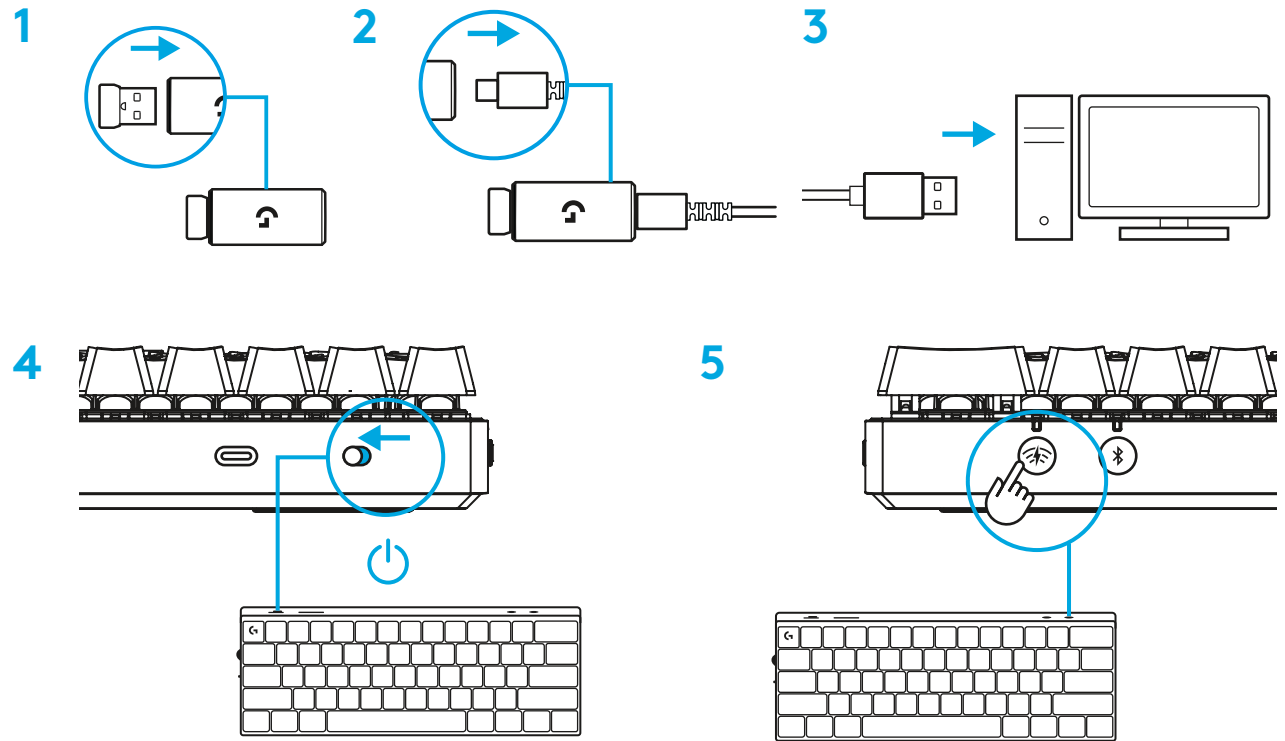

Stiahnite si a nainštalujte softvér G HUB do počítača PC/MAC, aby ste dosiahli čo najlepší herný zážitok (G HUB zahŕňa článok pre zoznámenie s funkciami). Prejdite na stránku www.logitechG.com/g Hub

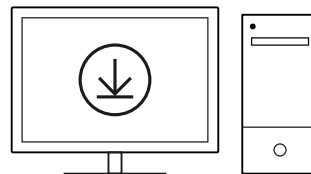

logitechG.com/g Hub

PRIPOJENIE BLUETOOTH®

1

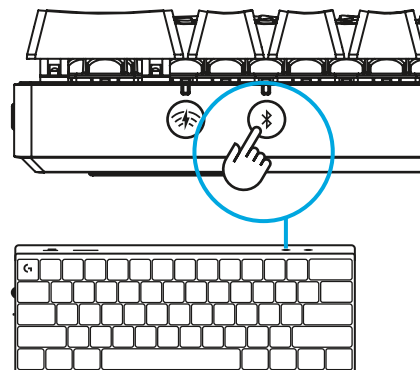

2

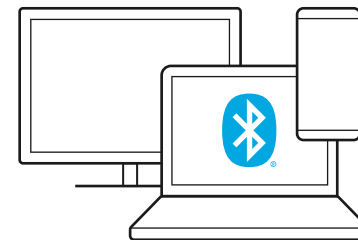

3

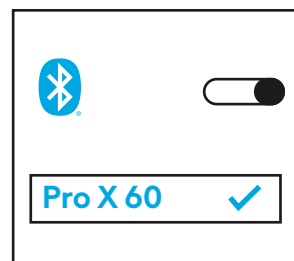

4

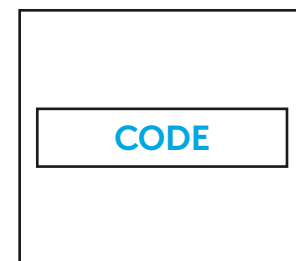

5

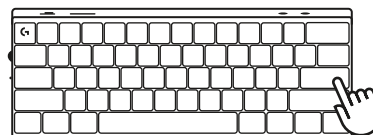

Stiahnite si a nainštalujte softvér G HUB do počítača PC/MAC, aby ste dosiahli čo najlepší herný zážitok (G HUB zahŕňa článok pre zoznámenie s funkciami). Prejdite na stránku www.logitechG.com/gHub

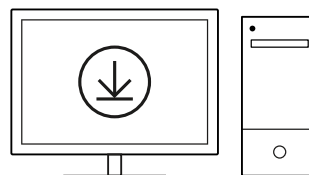

logitechG.com/gHub

NABÍJANIE KLÁVESNICE

1 Zastrčte kábel *USB-C* do portu v prednej časti klávesnice.

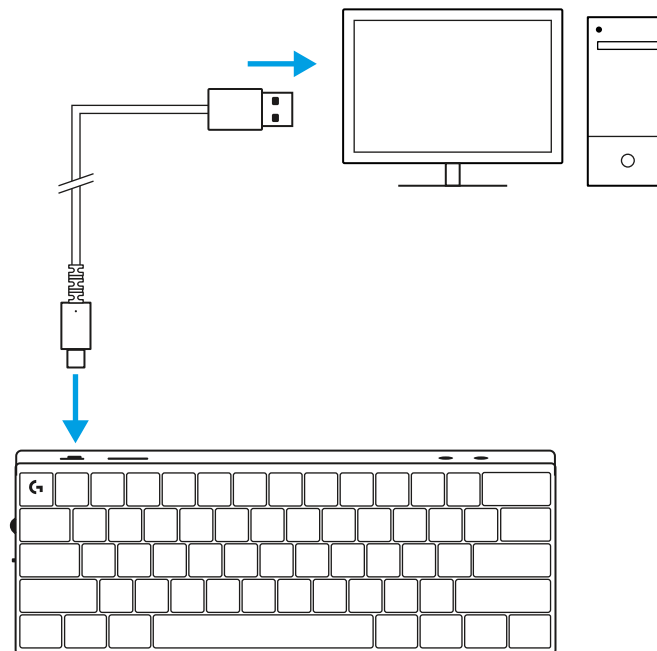

2 Pripojte kábel k počítaču PC.
Indikátor batérie bude počas nabíjania pulzovať zeleno
a po úplnom nabití sa rozsvieti zeleno.

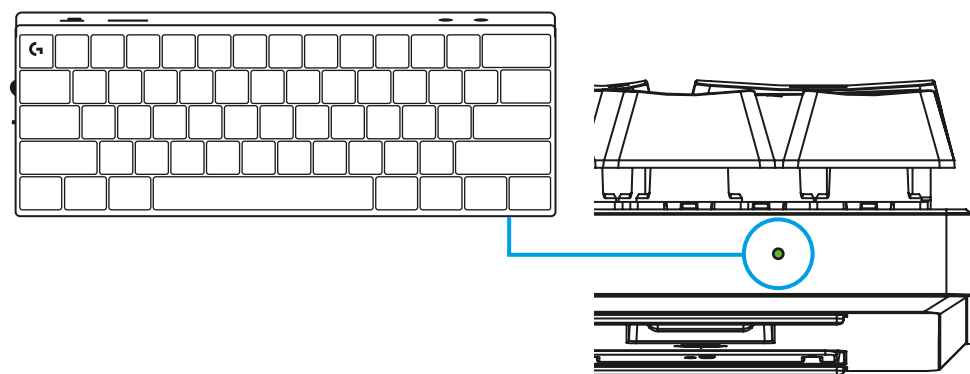

HERNÝ REŽIM





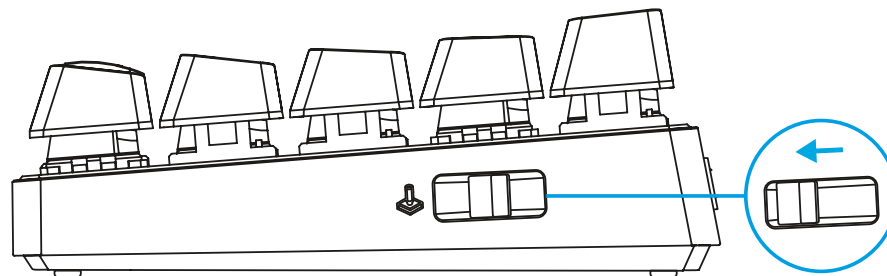



Zapnutie herného režimu deaktivuje funkcie klávesov Windows s cieľom zabrániť ich nechcenému spusteniu.

Deaktivovať môžete aj ďalšie klávesy v nastavení G HUB.







KOMBINÁCIE KLÁVESOV

Ovládacie prvky médií

 + 	Prehrať/pozastaviť
 + 	Stlmiť
 + 	Predchádzajúca stopa
 + 	Ďalšia stopa

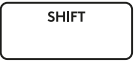
Klávesy Esc

 + 	~
 +  + 	~



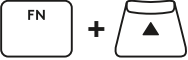
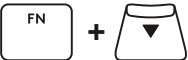
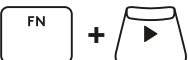
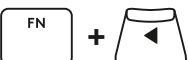

Klávesy so šípkami

	Šípka nahor
	Šípka nadol
	Šípka doprava
	Šípka doľava







Funkčné klávesy

	Snímka obrazovky
	Domov
	Page up
	Page down
	Scroll Lock
	End
	Insert
	Pause/Break



Ovládanie podsvietenia

 + 	Zníženie jasů klávesnice
 + 	Zvýšenie jasů klávesnice
 + 	Prechádzanie animačnými efektmi
 + 	Prechádzanie parametrami animácie

Prepínanie profilov

 + 	Aktivácia jedného z troch integrovaných pamäťových profilov
 + 	
 + 	

Úplné prispôsobenie klávesov zap/vyp

 + 	Povoliť úplné prispôsobenie klávesov
	Prepnúť medzi východiskovým a prispôsobeným rozložením

ОГЛЯД ПРОДУКТУ

Вигляд згори

- 1 Перемикач живлення
- 2 Порт Type-C
- 3 Кнопка *BLUETOOTH*[®]
- 4 Кнопка *LIGHTSPEED*
- 5 Перемикач ігрового режиму
- 6 Індикатор живлення
- 7 Регулятор гучності
- 8 Індикатор увімкнення Caps Lock



Вигляд знизу

- 1 Відсік для зберігання приймача
- 2 Ніжки для нахилу

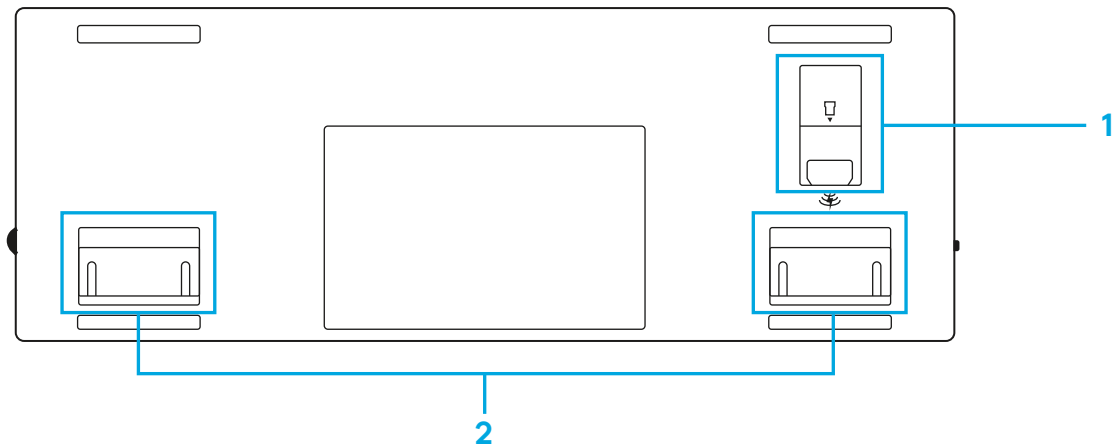

ПІДКЛЮЧЕННЯ ЗА ДОПОМОГОЮ LIGHTSPEED

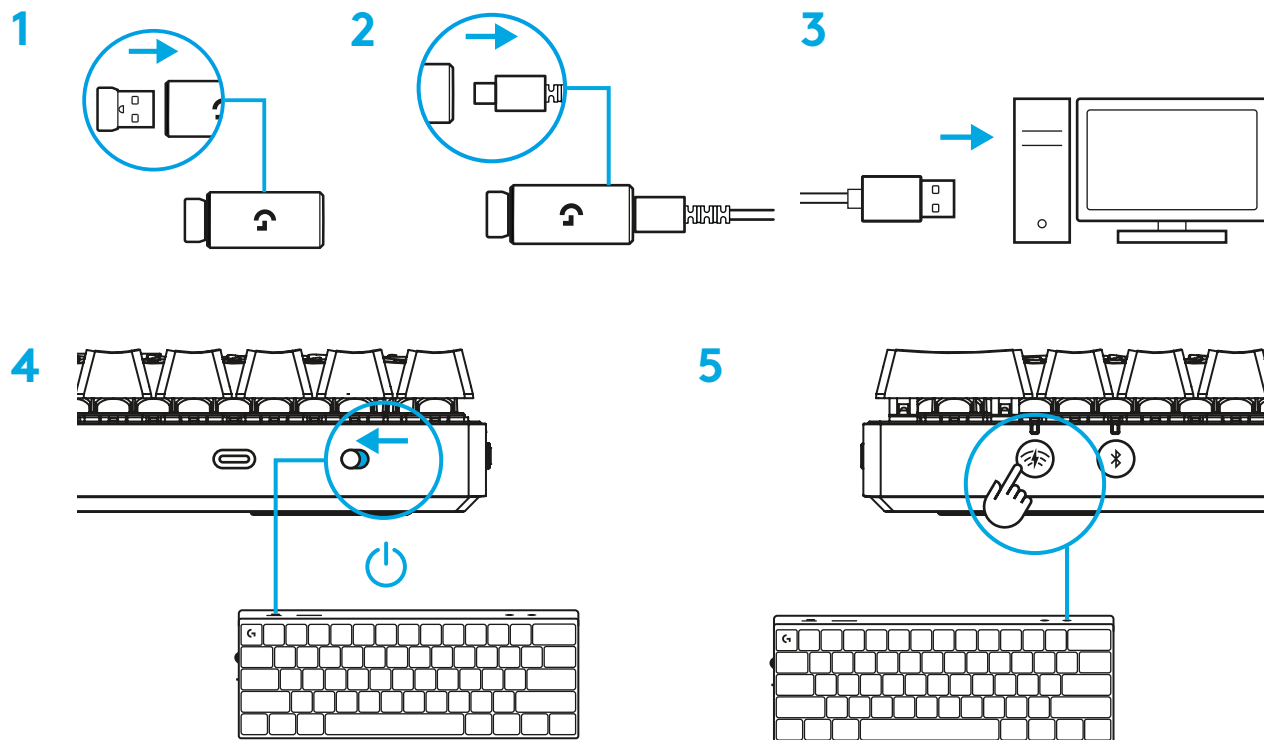

Щоб отримати ще більше крутих вражень від гри, завантажте та встановіть на свій ПК/МАС ПО G HUB (G HUB має вбудовану історію функцій).
Перейдіть за адресою www.logitechG.com/g Hub

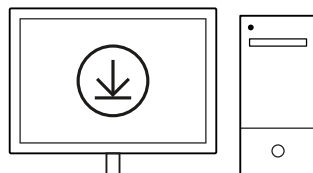

logitechG.com/g Hub

ПІДКЛЮЧЕННЯ ПО *BLUETOOTH*®

1

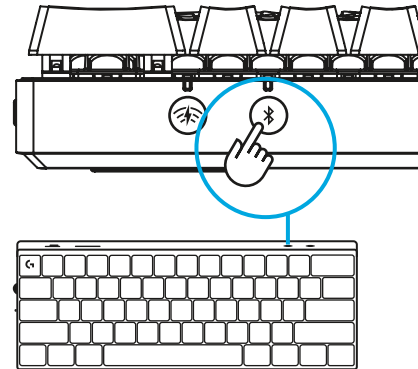

2

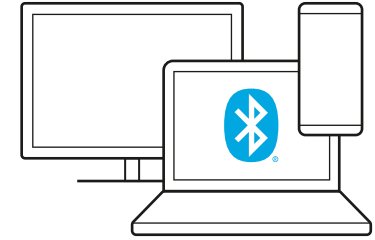

3

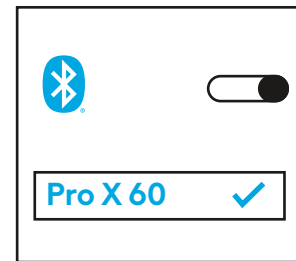

4

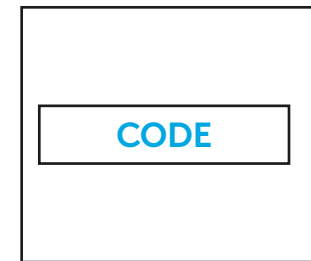

5

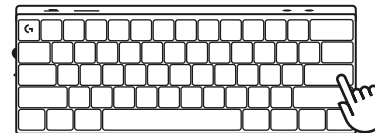

Щоб отримати ще більше крутих вражень від гри, завантажте та встановіть на свій ПК/МАС ПО G HUB (G HUB має вбудовану історію функцій).
Перейдіть за адресою www.logitechG.com/ghub

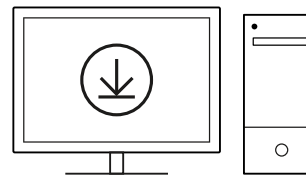

logitechG.com/ghub

ЗАРЯДЖАННЯ КЛАВІАТУРИ

- 1 Під'єднайте роз'єм *USB-C* кабелю до порту, розташованого спереду клавіатури.

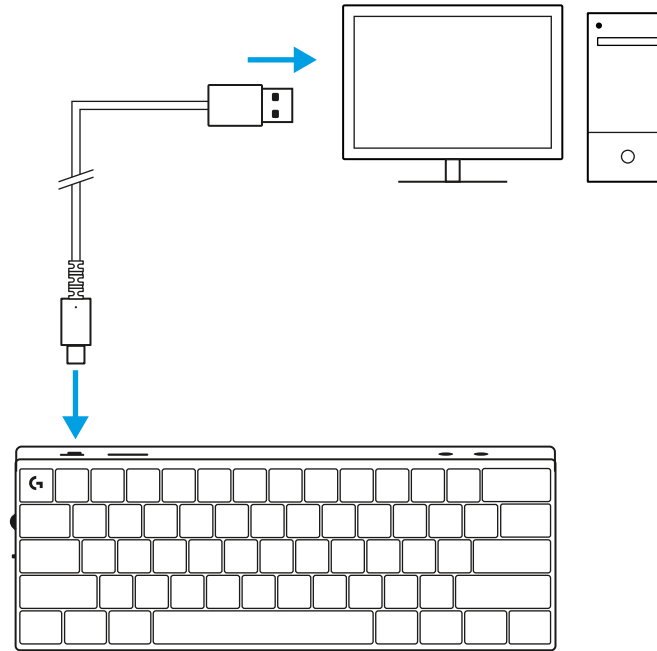

- 2 Під'єднайте другий роз'єм цього кабелю до ПК. Індикатор рівня заряду батареї блиматиме зеленим під час заряджання і стало горітиме зеленим, коли батарею буде заряджено повністю.

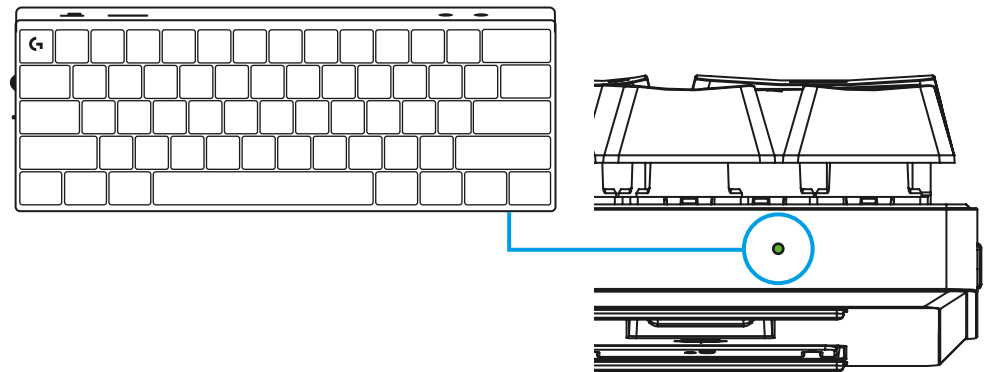

ІГРОВИЙ РЕЖИМ

Перехід в ігровий режим вимкне функції клавіші Windows задля уникнення випадкового спрацьовування.

Інші клавіші можна вимкнути в налаштуваннях G HUB.

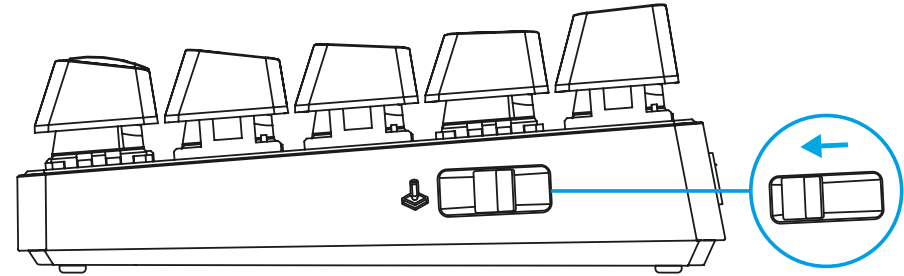





КОМБІНАЦІЇ КЛАВІШ





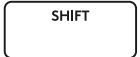



Елементи керування мультимедіа

 + 	Відтворення/пауза
 + 	Вимкнення звуку
 + 	Попередня композиція
 + 	Наступна композиція

















Клавіші ESC

 + 	`
 +  + 	~

Клавiші зі стрілками

 + 	Стрілка вгору
 + 	Стрілка вниз
 + 	Стрілка вправо
 + 	Стрілка вліво

Функціональні клавiші

 + 	Знімок екрана
 + 	Home
 + 	Page up
 + 	Page down
 + 	Scroll Lock
 + 	End
 + 	Insert
 + 	Pause/Break

Керування підсвічуванням

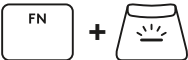
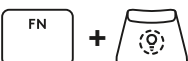
	Зменшення яскравості підсвічування клавіатури
	Збільшення яскравості підсвічування клавіатури
	Циклічне зміння ефектів підсвічування
	Циклічне зміння параметрів підсвічування

Перемикачі профілів

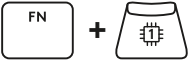
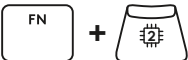
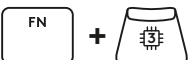
  	Активує один із трьох профілів із вбудованої пам'яті
-------------------------------------------------------------------------------------------------------------------------------------------------------------------------------------------------------------------------------------------------------------------	------------------------------------------------------

Повне налаштування клавіш увімк./вимк.

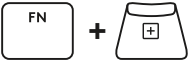
	Увімкнення повного налаштування клавіш
	Перемикач для переключення між стандартною і користувацькою розкладками

TOOTE ÜLEVAADE

Pealtvaade

- 1 Toitelüliti
- 2 Tüüp-C-port
- 3 BLUETOOTH®-nupp
- 4 LIGHTSPEED-nupp
- 5 Mängurežiimi lüliti
- 6 Toitenäidik
- 7 Helitugevuse regulaator
- 8 Suurtäheluku näidik



Altvaade

- 1 Tongli hoidik
- 2 Kallutusjalad

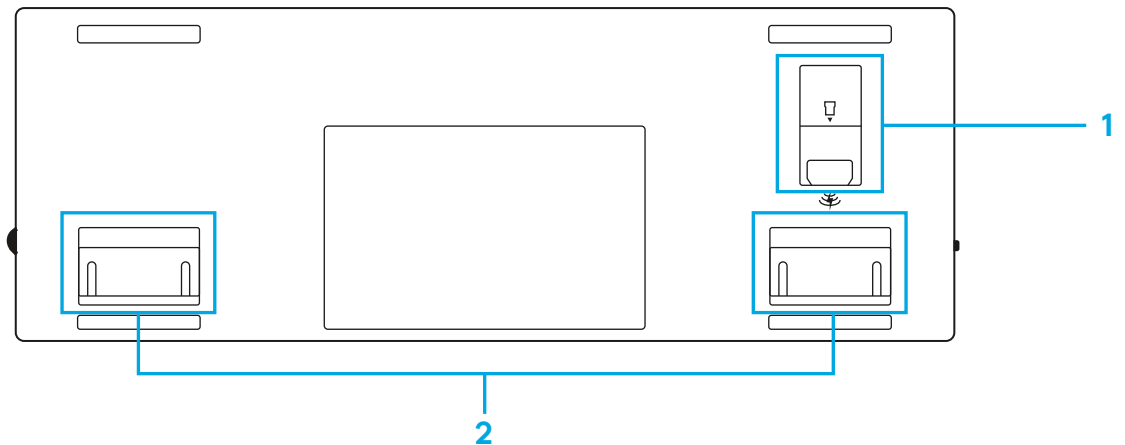

LIGHTSPEED-ÜHENDUS

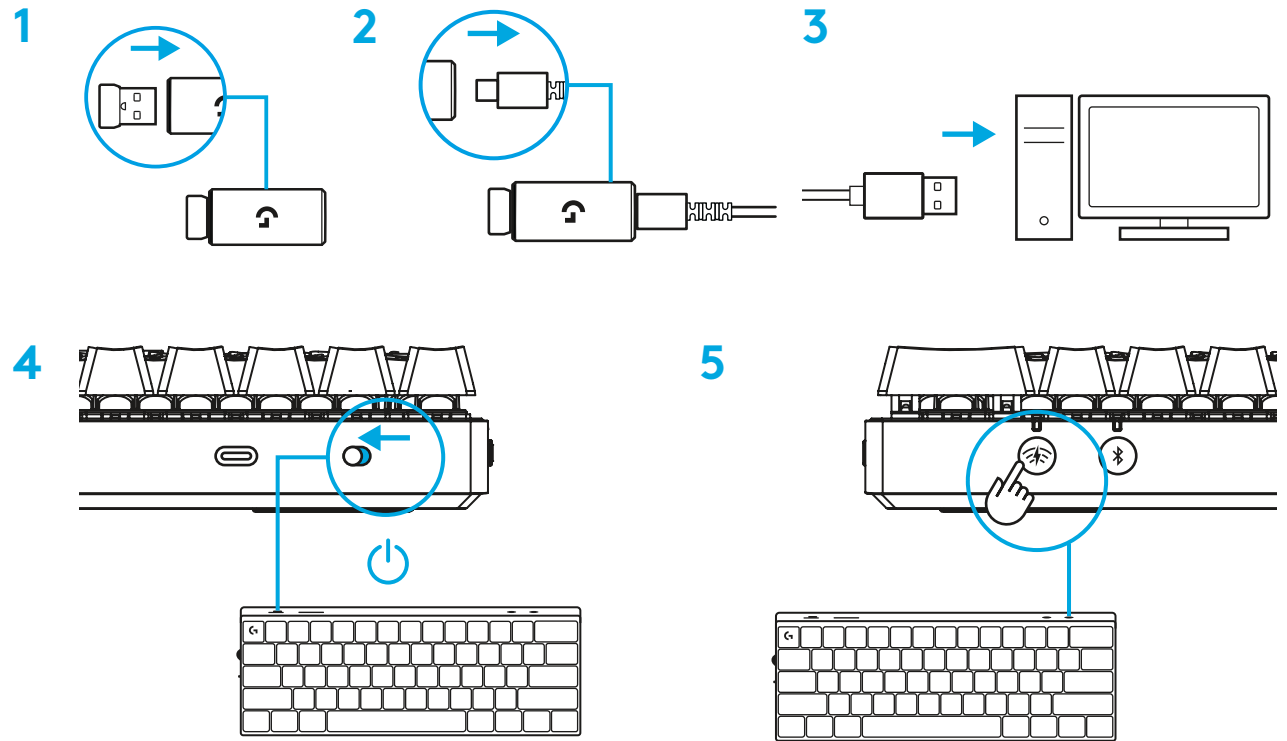

Parimaks mängimiseks laadige alla ja paigaldage oma arvutisse tarkvara G HUB (G HUB-il on funktsioonide kohta alustamisabi).
Avage www.logitechG.com/ghub

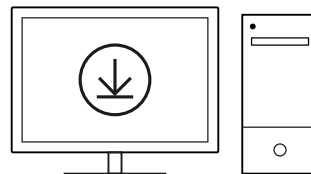

logitechG.com/ghub

BLUETOOTH®-ÜHENDUS

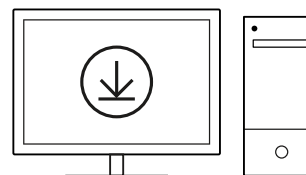
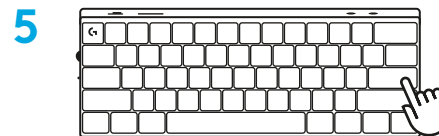
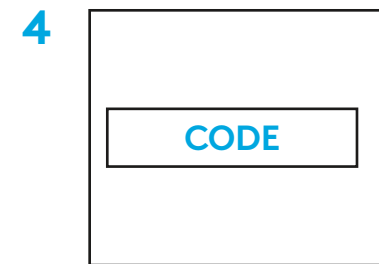
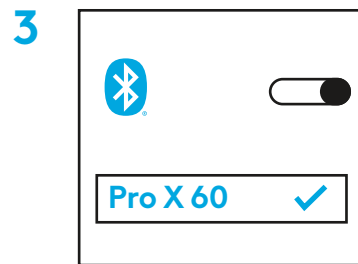
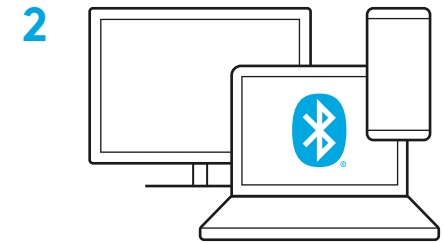
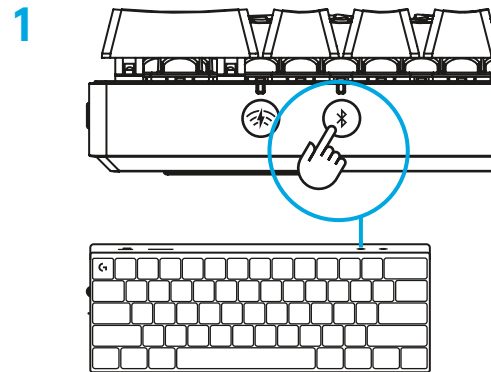

logitechG.com/ghub

Parimaks mängimiseks laadige alla ja paigaldage oma arvutisse tarkvara G HUB (G HUB-il on funktsioonide kohta alustamisabi).

Avage www.logitechG.com/ghub

KLAVIATUURI LAADIMINE

- 1 Sisestage *USB-C*-kaabel klaviatuuri esiküljel olevasse porti.

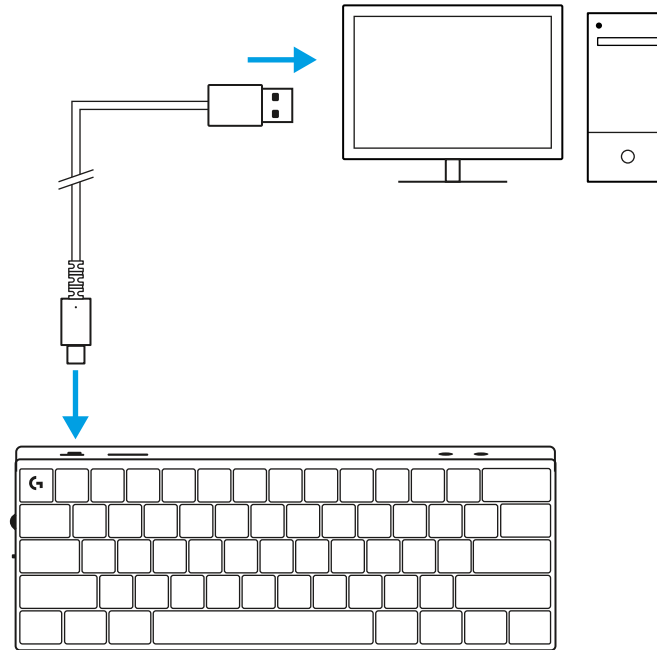

- 2 Ühendage kaabel arvutiga.
Aku märgutuli vilgub laadimise ajal roheliselt ja jääb täielikult laetud aku korral püsivalt rohelisena põlema.

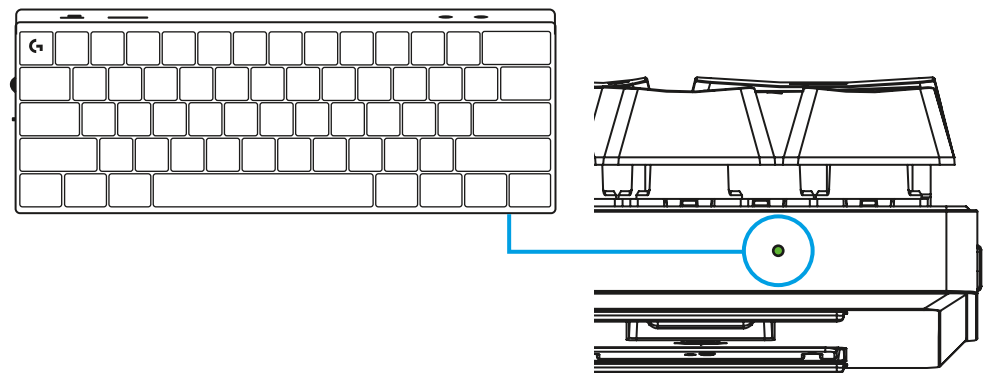

MÄNGUREŽIIM

Mängurežiimi sisselülitamine inaktiveerib Windows-klahvi funktsioonid, et vältida võimalikku juhuslikku käivitamist.

Teil on võimalik keelata erinevaid klahve ka Ghubi seadetes.

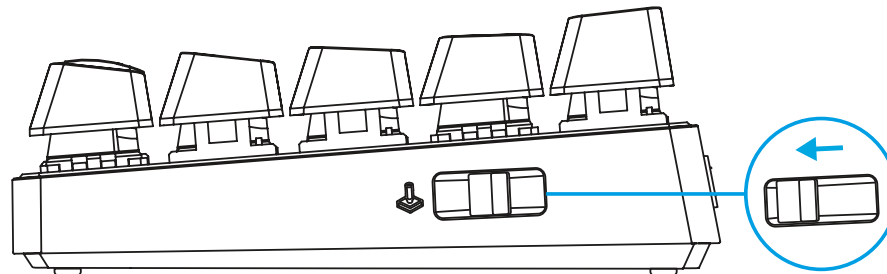



KLAHVIKOMBINATSIOONID

Meediuminupud

FN + 	Esitus/paus
FN + 	Vaigistus
FN + 	Eelmine pala
FN + 	Järgmine pala

Väljumisklahvid

FN + 	`
FN + SHIFT + 	~

Nooleklahvid

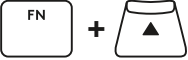
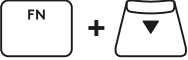
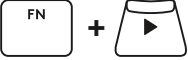
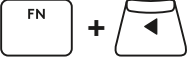
	Ülesnool
	Allanool
	Paremnool
	Vasaknool







Funktsiooniklahvid

	Kuvatõmmis
	Kodu
	Leht üles
	Leht alla
	Kerimislukk
	Lõpp
	Sisestusklahv
	Paus/tühik



Valgustuse juhtimine

 + 	Klaviatuuri heleduse vähendamine
 + 	Klaviatuuri heleduse suurendamine
 + 	Animatsiooniefektide tsükkel
 + 	Animatsiooni parameetrite tsükkel

Profiililülitid

 +   +   + 	Aktiveerib ühe kolmest salvestatud mälu profiilist
-------------------------------------------------------------------------------------------------------------------------------------------------------------------------------------------------------------------------------------------------------------------------------------------------------------------------------------------------------------------------------------------------------------------------------------------------------------------------------------------------------------------------------------	----------------------------------------------------

Kõikide klahvide kohandamine sees/väljas

 + 	Kõikide klahvide kohandamise lubamine
	Lüliti vaike- ja kohandatud paigutuse vahel valimiseks

IZSTRĀDĀJUMA PĀRSKATS

Skats no augšpuses

- 1 Ieslēgšanas/izslēgšanas slēdzis
- 2 C tipa pieslēgvietā
- 3 Poga "BLUETOOTH"®
- 4 Poga "LIGHTSPEED"
- 5 Spēļu režīma ieslēgšanas slēdzis
- 6 Ieslēgšanas/izslēgšanas indikators
- 7 Skaljuma regulēšanas ritenītis
- 8 Burtslēga taustiņa indikators

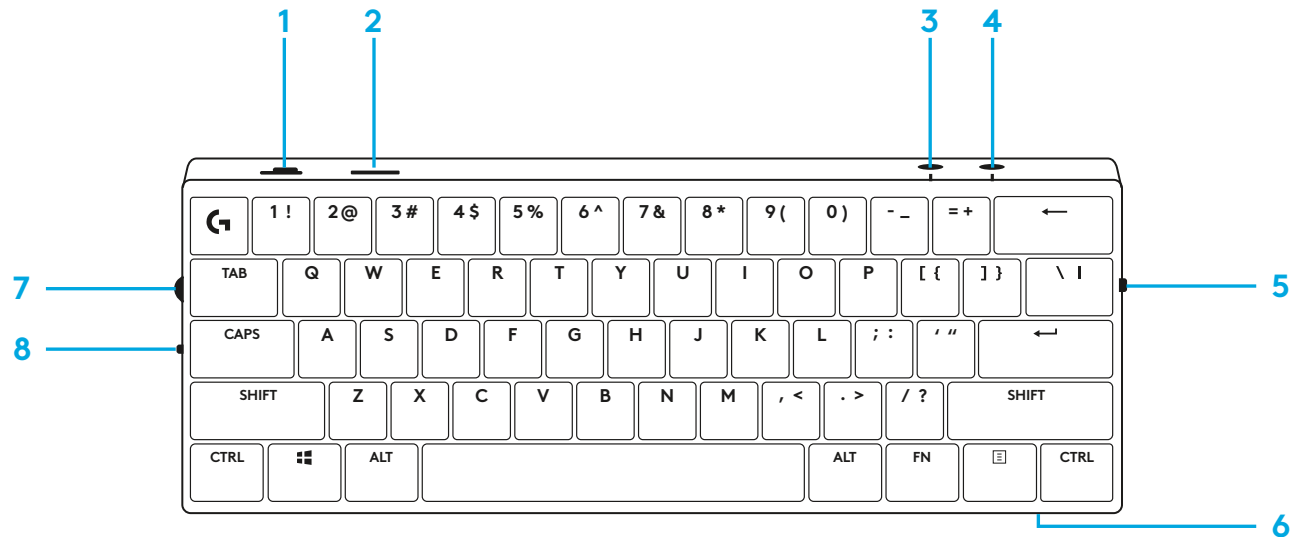

Skats no apakšpuses

- 1 Spraudņa nodalījums
- 2 Kājiņas saskāšanās vieta

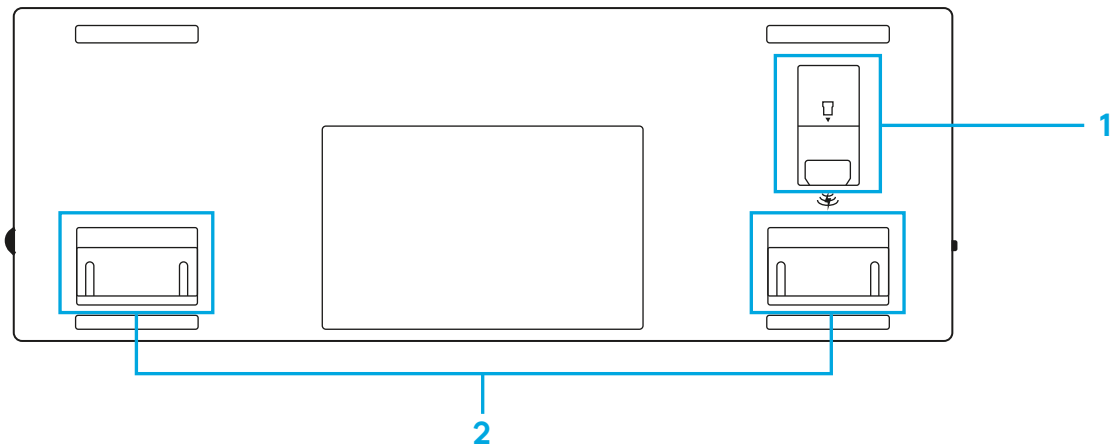

"LIGHTSPEED" SAVIENOJUMS

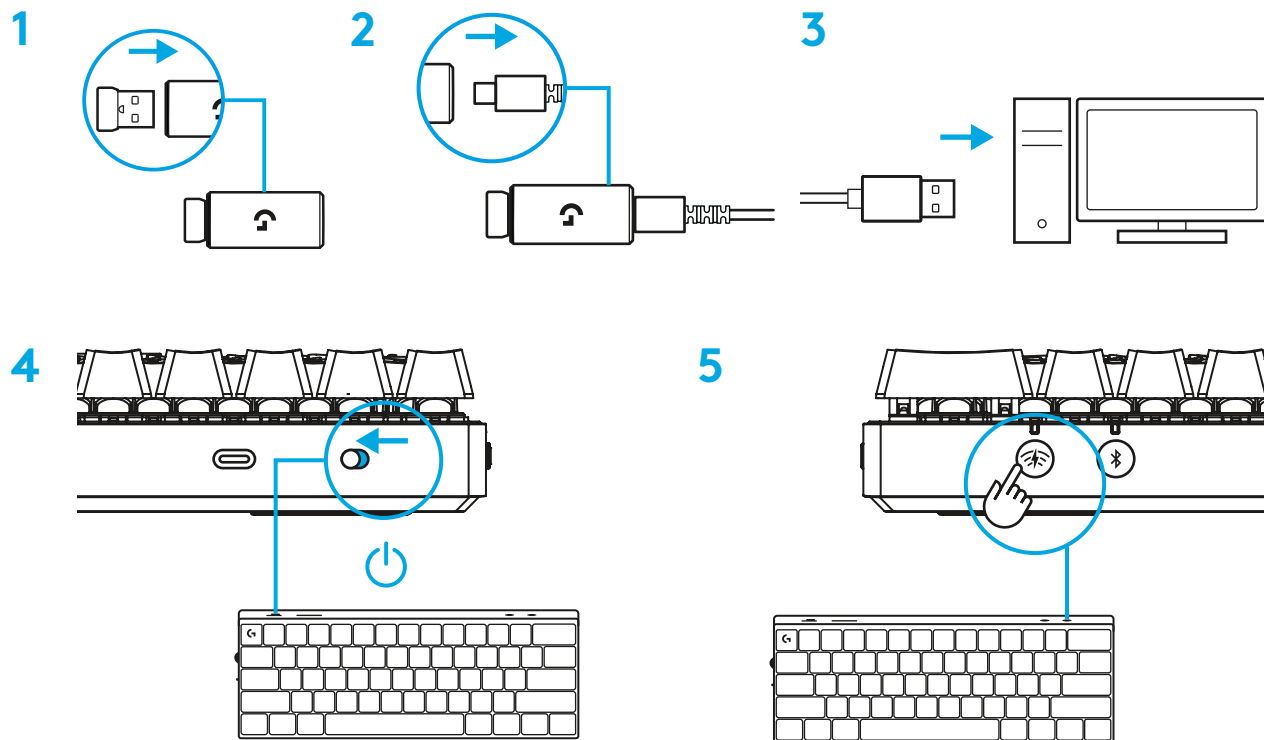

Lejupielādējiet un instalējiet "G HUB" programmatūru savam "Windows"/"MAC" datoram, lai iegūtu vislabāko iespējamo spēlēšanas pieredzi ("G HUB" programmatūrā ir pieejama apmācība par funkcijām). Dodieties uz vietni www.logitechG.com/ghub

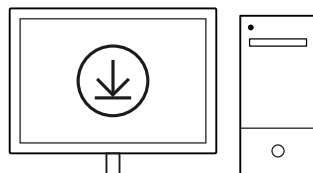

logitechG.com/ghub

BLUETOOTH® SAVIENOJUMS

1

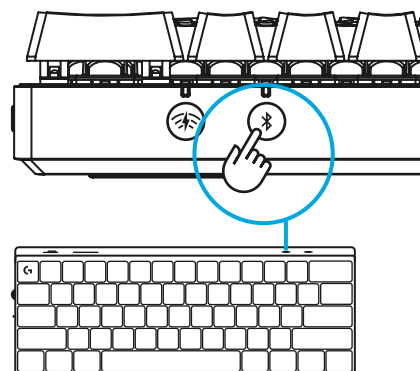

2

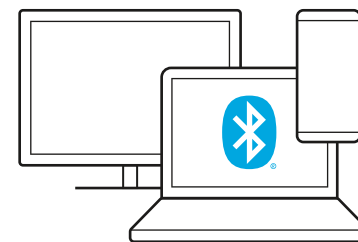

3

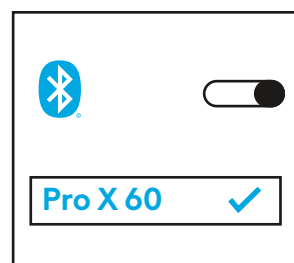

4

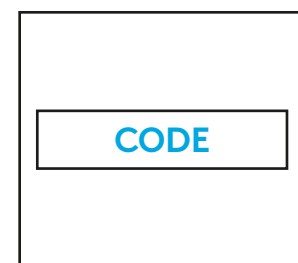

5

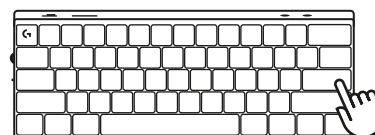

Lejupielādējiet un instalējiet "G HUB" programmatūru savam "Windows"/"MAC" datoram, lai iegūtu vislabāko iespējamo spēlēšanas pieredzi ("G HUB" programmatūrā ir pieejama apmācība par funkcijām). Dodieties uz vietni www.logitechG.com/ghub

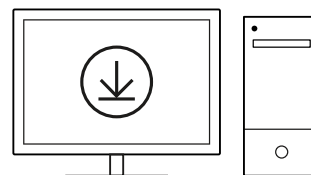

logitechG.com/ghub

TASTATŪRAS UZLĀDE

- 1 Iespraudiet *USB-C* kabeli tam paredzētajā pieslēgvieta tāstaturas priekšdaļā.

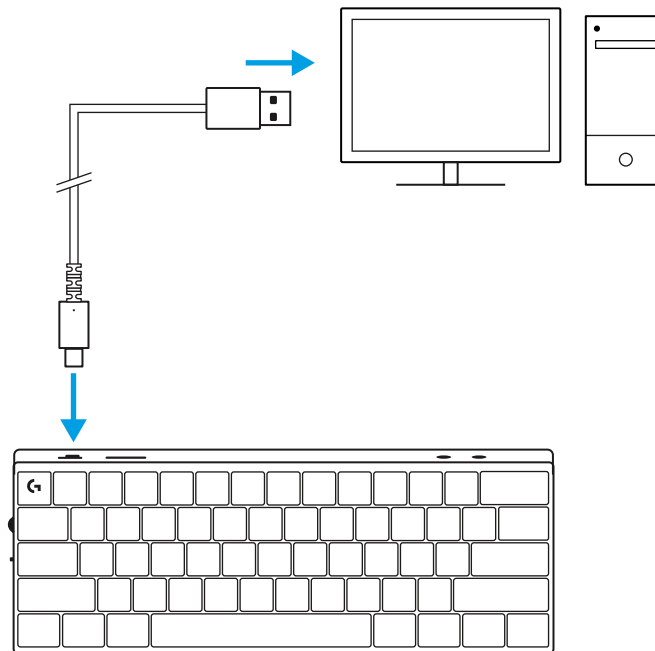

- 2 Pievienojiet kabeli datoram.
Akumulatora uzlādes indikators mirgos zaļā krāsā uzlādes laikā un, kad būs pilnībā uzlādēts, degs zaļā krāsā.

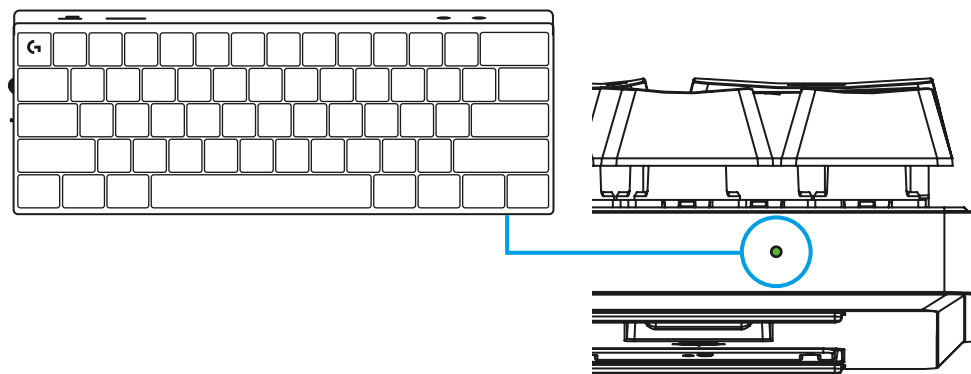

SPĒĻU REŽĪMS





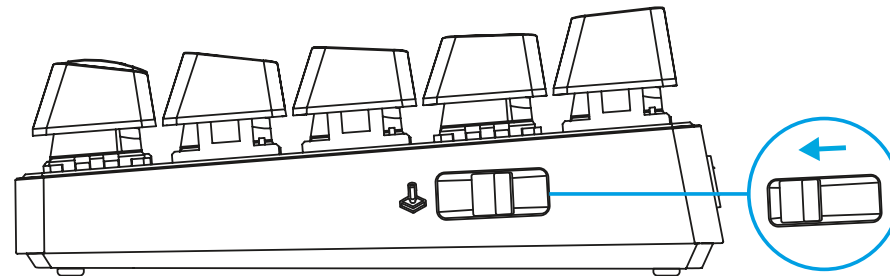

Ar spēļu režīma slēdzi var atspējot "Windows" taustiņu funkcijas, lai izvairītos no nejaušas to aktivizēšanas.

"Ghub" iestatījumos varat atspējot arī citus taustiņus.







TAUSTIŅU KOMBINĀCIJAS

Multivides satura vadīklas

 + 	Atskaņot/pauzēt
 + 	Izslēgt skaņu
 + 	Iepriekšējais ieraksts
 + 	Nākamais ieraksts

Atsoļa (ESC) taustiņi

 + 	`
 +  + 	~

Bulttaustiņi

	Augšupbultiņa
	Lejupbultiņa
	Labā bultiņa
	Kreisā bultiņa

Funkciju taustiņi

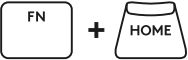
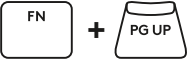
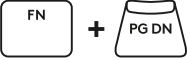
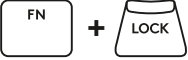
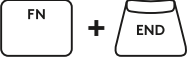
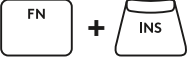
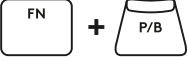
	Ekrānuzņēmums
	Sākums
	Iepriekšējā lappuse
	Nākamā lappuse
	Ritslēga taustiņa bloķēšana
	Uz beigām
	Ievietot
	Apstādināt

Apgaismojuma kontrole

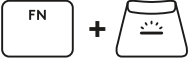
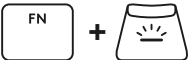
	Samazināt tastatūras spilgtumu
	Palielināt tastatūras spilgtumu
	Pārslēgties starp apgaismojuma efektiem
	Pārslēgties starp apgaismojuma parametriem

Pārslēgšanās starp profiliem

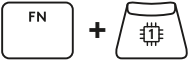
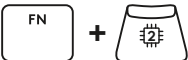
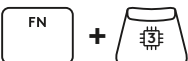
  	Aktivizēt vienu no trim atmiņā iebūvētajiem profiliem
-------------------------------------------------------------------------------------------------------------------------------------------------------------------------------------------------------------------------------------------------------------------	-------------------------------------------------------

Visu taustiņu pielāgošanas režīma ieslēgšana/izslēgšana

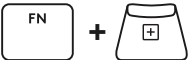
	Iespējot visu taustiņu pielāgošanu
	Pārslēgties starp noklusējuma un pielāgoto izkārtojumu

PRODUKTO APŽVALGA

Vaizdas iš viršaus

- 1 Maitinimo jungiklis
- 2 C tipo prievadas
- 3 **BLUETOOTH**[®] mygtukas
- 4 **LIGHTSPEED** mygtukas
- 5 Žaidimo režimo jungiklis
- 6 Maitinimo indikatorius
- 7 Garso ratukas
- 8 „Caps Lock“ indikatorius



Vaizdas iš apačios

- 1 Rakto saugykla
- 2 Pakėlimo kojelės

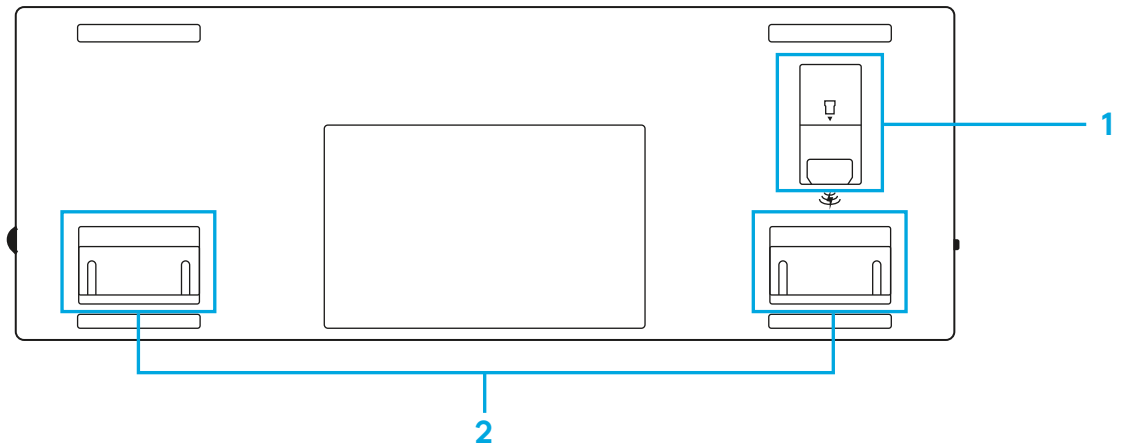

„LIGHTSPEED“ PRIJUNGIMAS

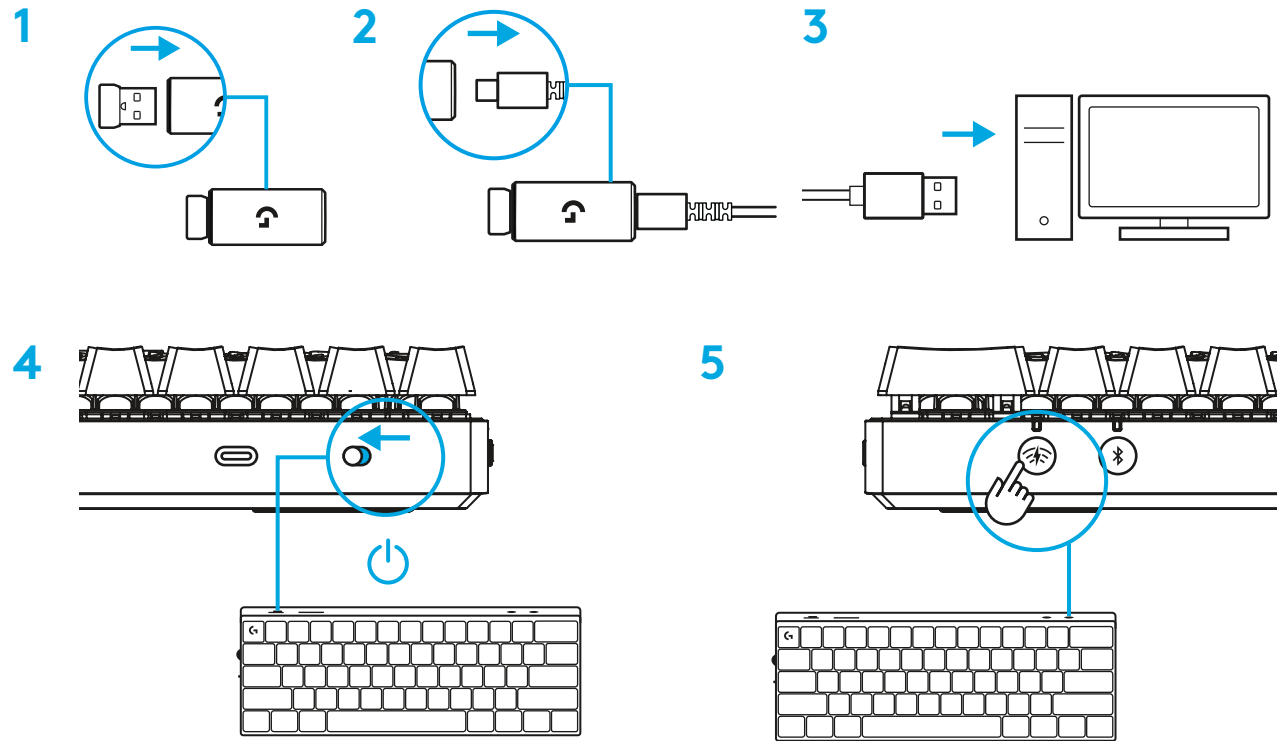

Atsisiųskite ir įdiekite G HUB programinę įrangą į savo kompiuterį / MAC, kad užtikrintumėte geriausių žaidimo patirtį (G HUB yra funkcijų istorija). Eikite į www.logitechG.com/ghub

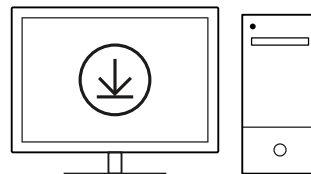

logitechG.com/ghub

„BLUETOOTH®“ PRIJUNGIMAS

1

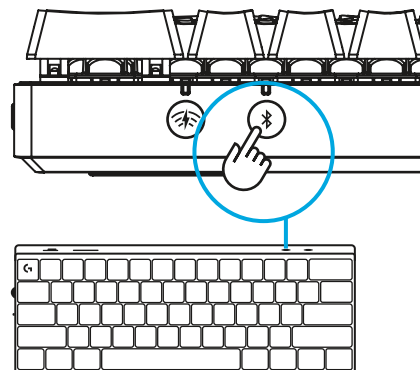

2

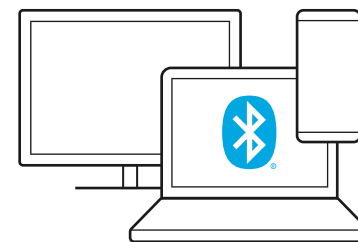

3

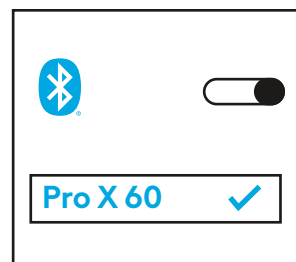

4

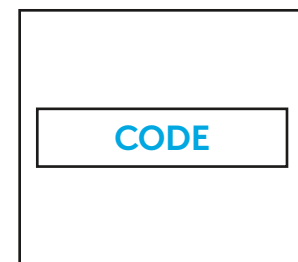

5

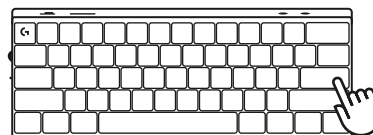

Atsiųskite ir įdiekite G HUB programinę įrangą į savo kompiuterį / MAC, kad užtikrintumėte geriausią žaidimo patirtį (G HUB yra funkcijų istorija). Eikite į www.logitechG.com/ghub

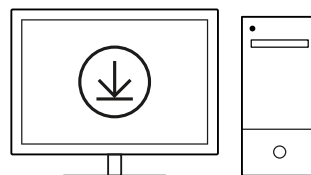

logitechG.com/ghub

KLAVIATŪROS ĮKROVIMAS

- 1 Prijunkite *USB-C* laidą prie prievado, esančio klaviatūros priekyje.

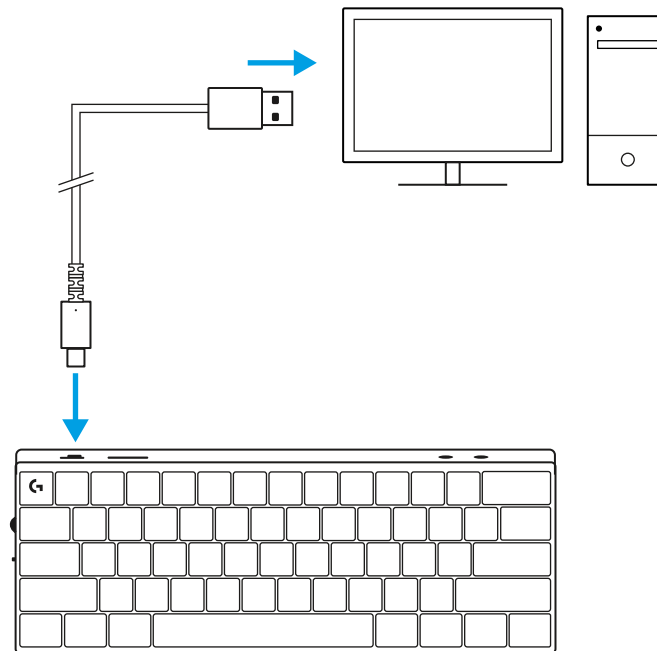

- 2 Prijunkite laidą prie savo kompiuterio. Įkraunant akumuliatoriaus indikatorius lemputė mirksi žaliai, o visiškai įkrovus – šviečia žaliai.

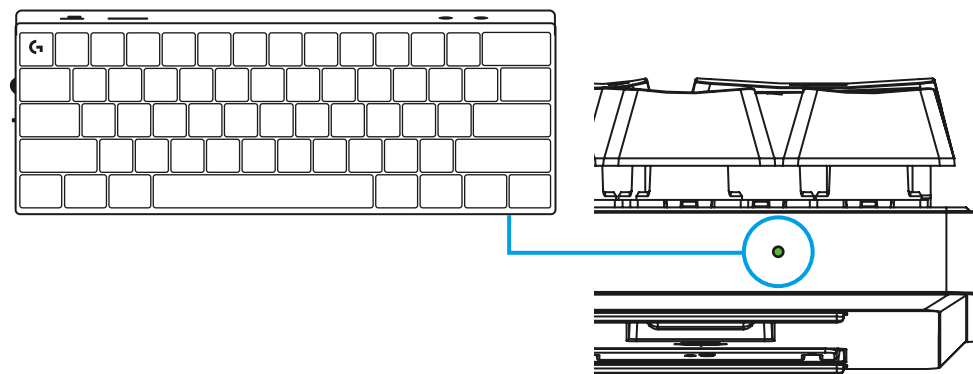

ŽAIDIMŲ REŽIMAS





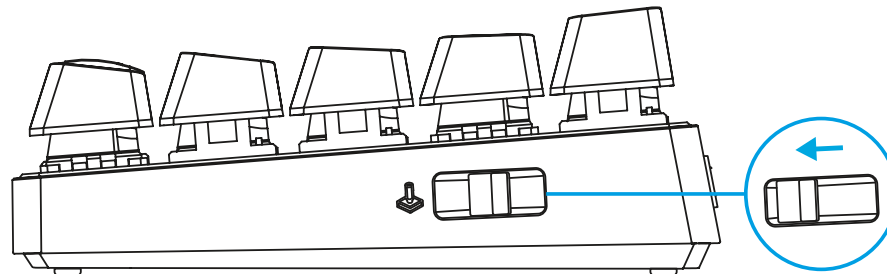



Ijungus žaidimų režimą, bus išjungtos „Windows“ klavišų funkcijos, kad jos nebūtų netyčia aktyvuotos.

Taip pat galite išjungti skirtingus klavišus „Ghub“ nustatymuose.







KLAVIŠŲ DERINIAI

Medijos valdikliai

 + 	Leisti / pristabdyti
 + 	Nutildyti
 + 	Ankstesnis takelis
 + 	Kitas takelis

ESC klavišai

 + 	~
 +  + 	~



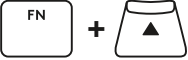
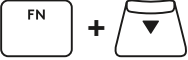
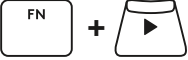
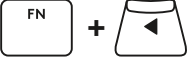





Rodyklių klavišai

	Rodyklė aukštyn
	Rodyklė žemyn
	Rodyklė dešinėn
	Rodyklė kairėn







Funkciniai klavišai

	Ekranų kopija
	Pradžia
	Puslapis aukštyn
	Puslapis žemyn
	Slinkties užraktas
	Baigti
	Įterpti
	Pristabdyti / stabdyti



Apšvietimo valdymas

 + 	Sumažinti klaviatūros ryškumą
 + 	Padidinti klaviatūros ryškumą
 + 	Perjungti animacijos efektą
 + 	Perjungti animacijos parametrus

Profilio perjungimas

 + 	Aktyvuokite vieną iš trijų atminties profilių
 + 	
 + 	

Visiško klaviatūros tinkinimo įjungimas / išjungimas

 + 	Įjungti visišką klaviatūros tinkinimą
	Perjungti tarp numatytojo ir tinkinamo išdėstymo

ОБЩ ПРЕГЛЕД НА ПРОДУКТА

Изглед отгоре

- 1 Прекъсвач за захранването
- 2 Порт Тур-С
- 3 Бутон *BLUETOOTH*[®]
- 4 Бутон *LIGHTSPEED*
- 5 Превключвател за режима на игра
- 6 Индикатор на захранването
- 7 Колелце за силата на звука
- 8 Индикатор на клавиш Caps Lock

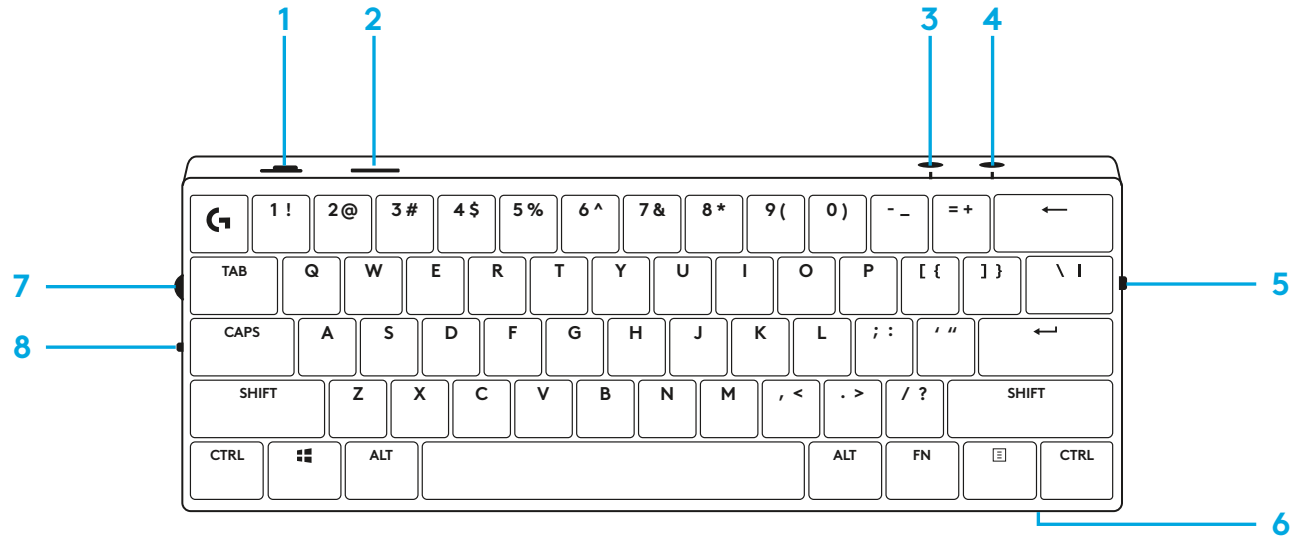

Изглед отдолу

- 1 Съхранение на ключ за порт
- 2 Гъвкави крачета

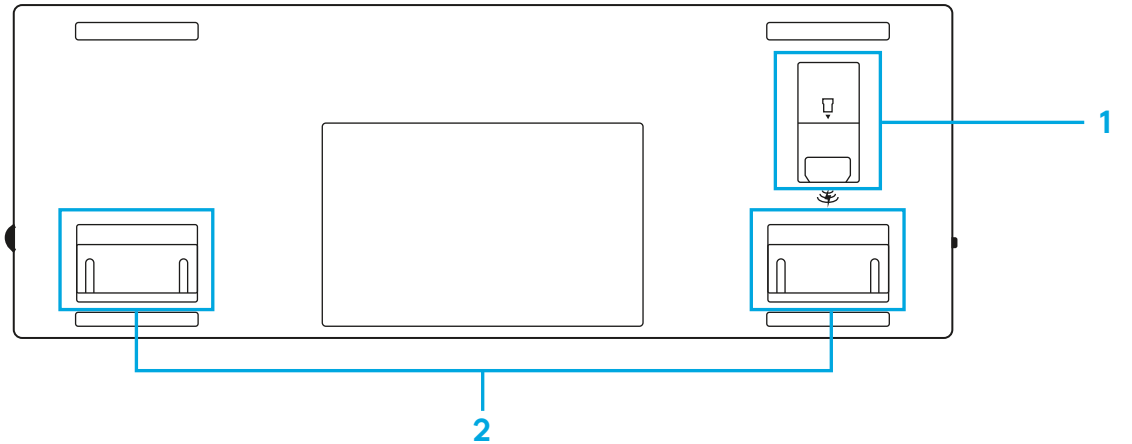

LIGHTSPEED ВРЪЗКА

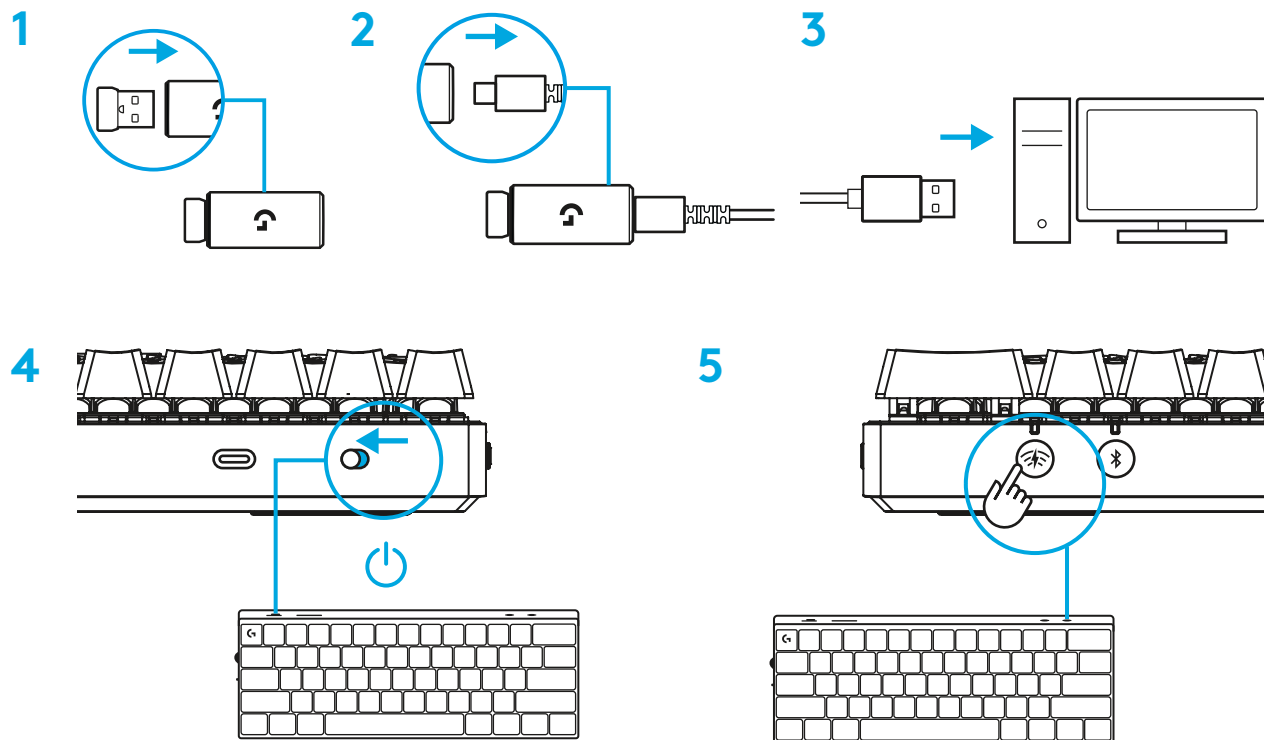

Изтеглете и инсталирайте софтуера G HUB на вашия PC/MAC и ще си осигурите възможно най-доброто гейминг изживяване (G HUB предлага първоначално въвеждане, с което представя нови функции).
Отидете на www.logitechG.com/ghub

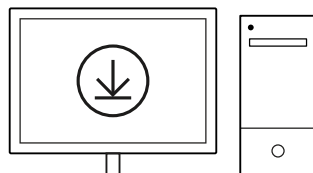

logitechG.com/ghub

BLUETOOTH® ВРЪЗКА

1

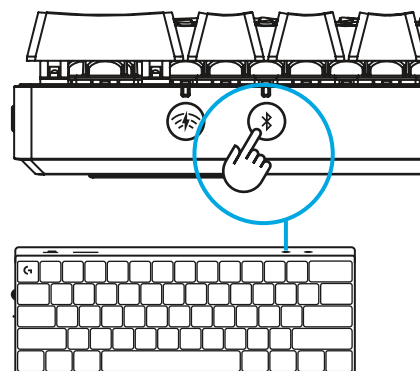

2

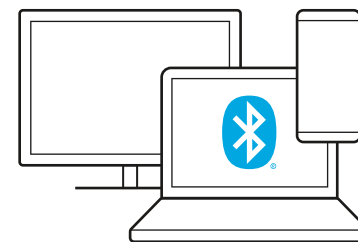

3

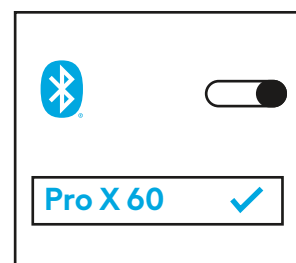

4

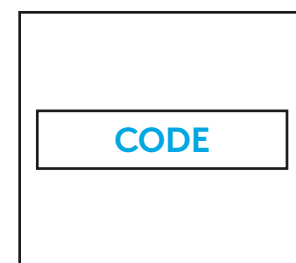

5

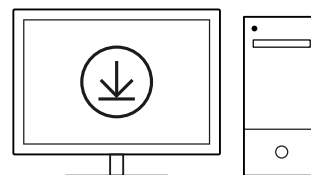
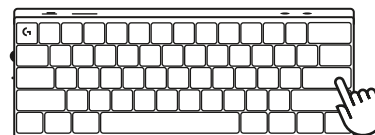

logitechG.com/g Hub

Изтеглете и инсталирайте софтуера G HUB на вашия PC/MAC и ще си осигурите възможно най-доброто гейминг изживяване (G HUB предлага първоначално въвеждане, с което представя нови функции).

Отидете на www.logitechG.com/g Hub

ЗАРЕЖДАНЕ НА КЛАВИАТУРАТА

- 1 Пъхнете *USB-C* кабела в порта, разположен отпред на клавиатурата.

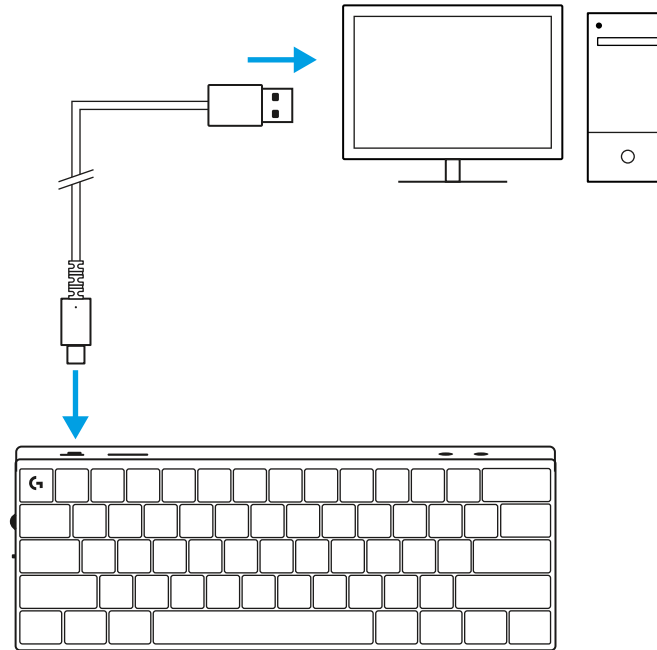

- 2 Свържете кабела с компютъра си. Светлинният индикатор на батерията ще мига в зелено по време на зареждане и ще свети в постоянно зелено, след като се зареди напълно.

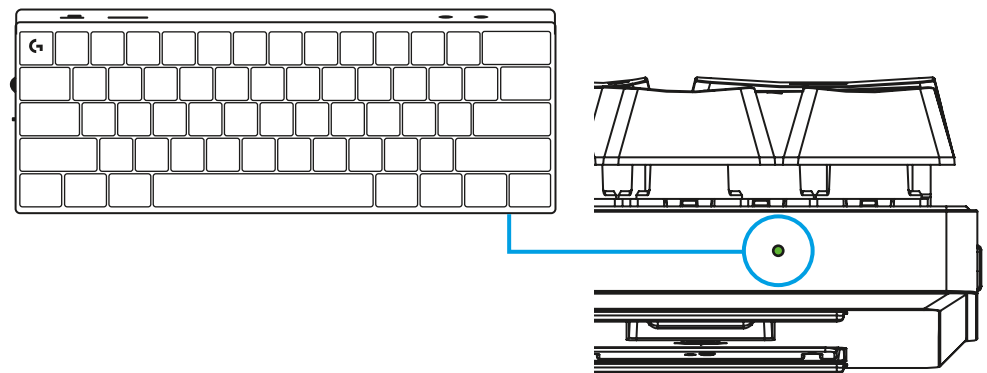

ГЕЙМИНГ РЕЖИМ

Превключването на гейминг режим ще дезактивира функциите на клавиша Windows с цел да се избегне неволно задействане.

В настройките на Ghub можете да деактивирате различни клавиши.

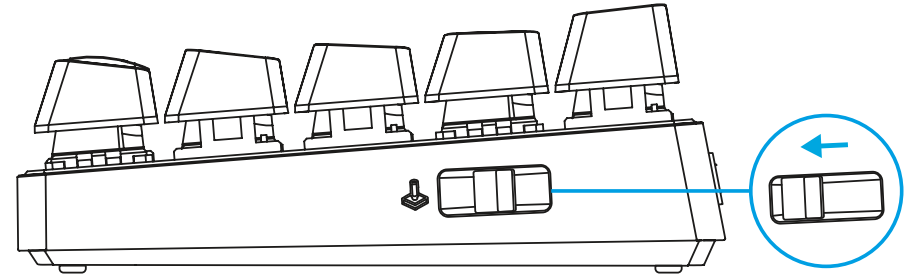





КОМБИНАЦИИ ОТ КЛАВИШИ

Контроли за мултимедия

 + 	Възпроизвеждане/ пауза
 + 	Изключване на звука
 + 	Предишна песен
 + 	Следваща песен

Клавиши ESC

 + 	~
 +  + 	~

Клавиши със стрелки

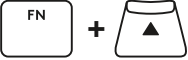
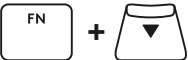
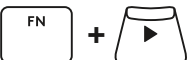
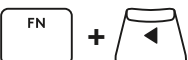
	Стрелка нагоре
	Стрелка надолу
	Стрелка надясно
	Стрелка наляво

Функционални клавиши

	Екранна снимка
	Начало
	Страница нагоре
	Страница надолу
	Scroll Lock
	Край
	Вмъкване
	Пауза/Прекъсване

Управление на светлинните настройки

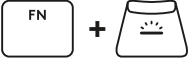
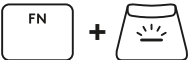
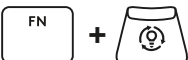
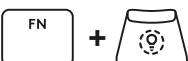
	Намалявате яркостта на клавиатурата
	Увеличавате яркостта на клавиатурата
	Превключвате ефекти на анимиране
	Превключвате параметри на анимиране

Превключватели на профил

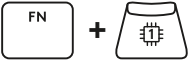
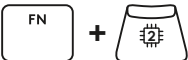
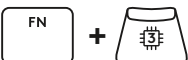
  	Активирате един или три външни профили на паметта
-------------------------------------------------------------------------------------------------------------------------------------------------------------------------------------------------------------------------------------------------------------------	---------------------------------------------------

Вкл./изкл. на цялостно персонализиране на клавиш

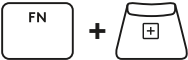
	Разрешаване на цялостно персонализиране на клавиш
	Смяна на превключване между Основно и Персонализирано оформление

PREGLED PROIZVODA

Pogled s gornje strane

- 1 Sklopka za uključivanje/isključivanje
- 2 Priključak tip C
- 3 Gumb *BLUETOOTH*[®]
- 4 Gumb *LIGHTSPEED*
- 5 Sklopka za način igranja
- 6 Indikator napajanja
- 7 Kotačić za glasnoću
- 8 Indikator velikih slova

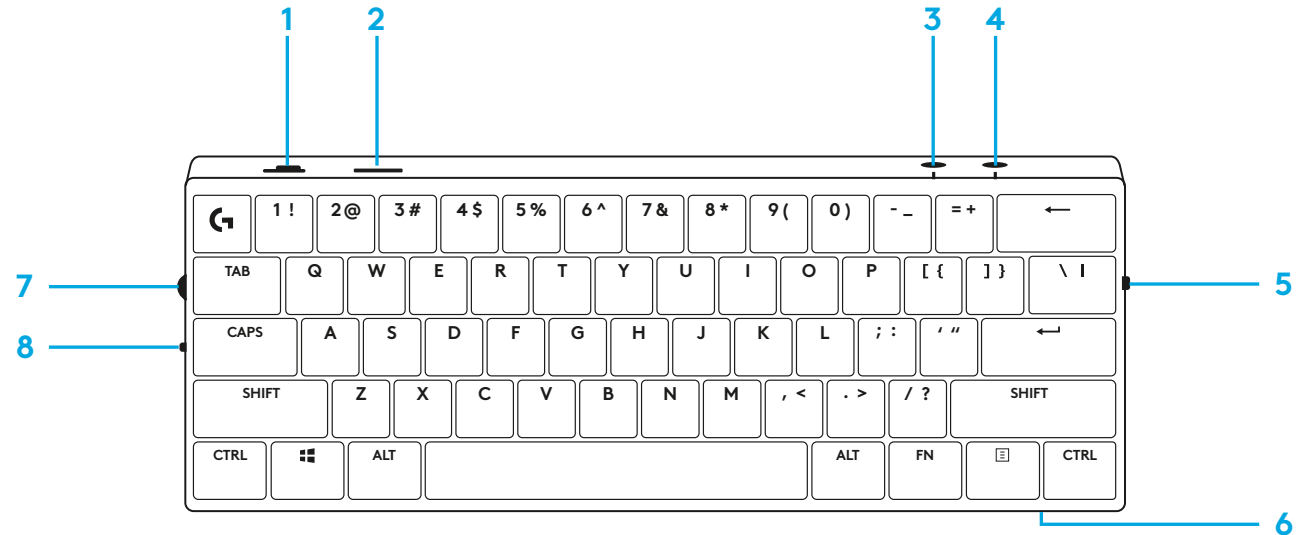

Pogled s donje strane

- 1 Pohrana sigurnosnog modula
- 2 Nožice za naginjanje

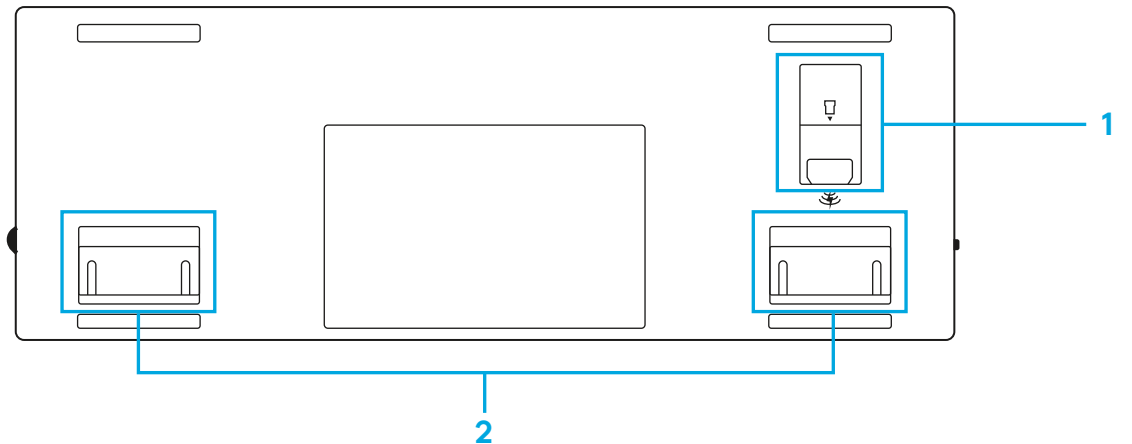

LIGHTSPEED VEZA

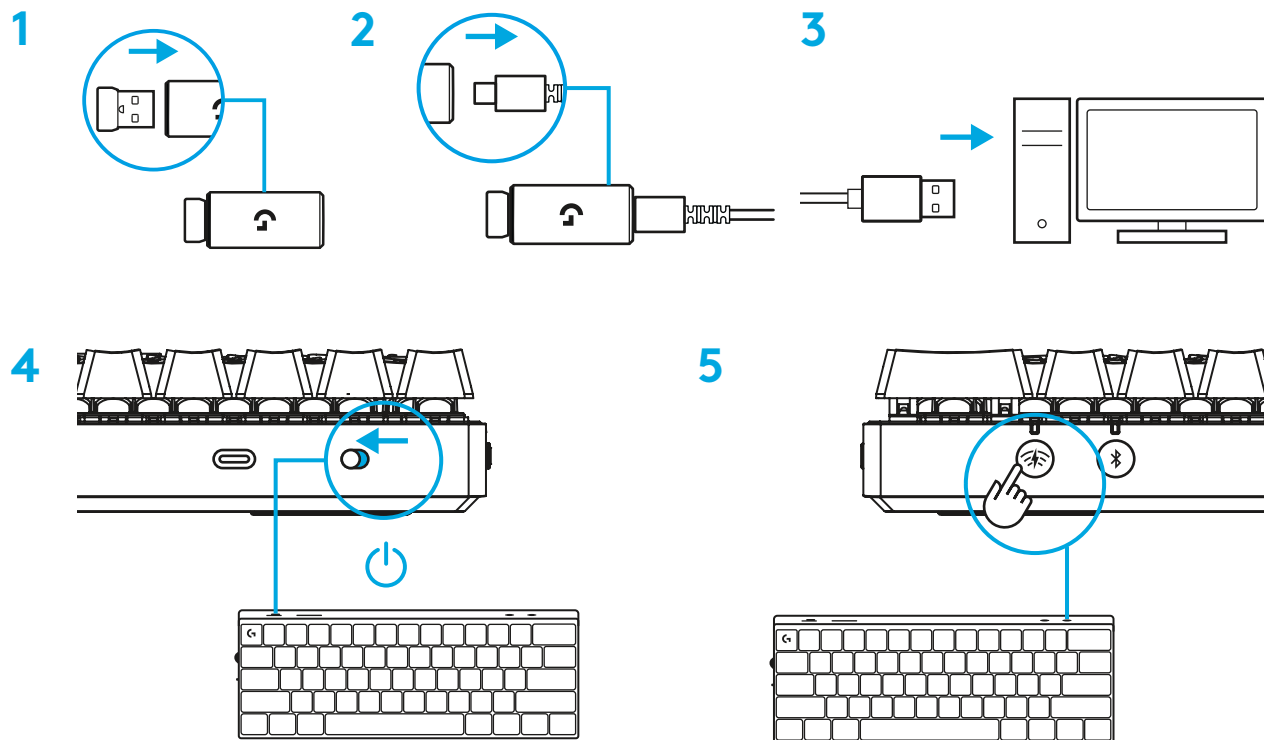

Preuzmite i instalirajte softver za G HUB na PC/MAC računalo radi najboljeg doživljaja igranja (G HUB sadrži u sebi opis značajki).
Otvorite www.logitechG.com/ghub

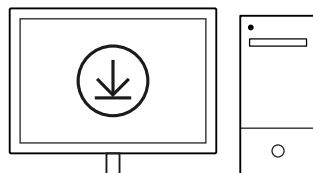

logitechG.com/ghub

BLUETOOTH® VEZA

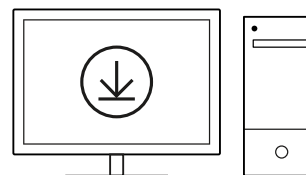
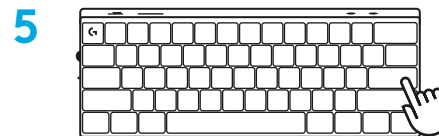
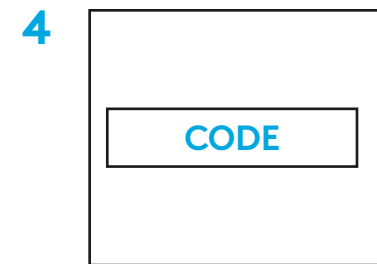
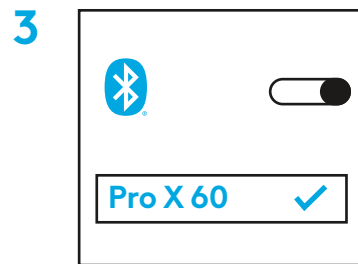
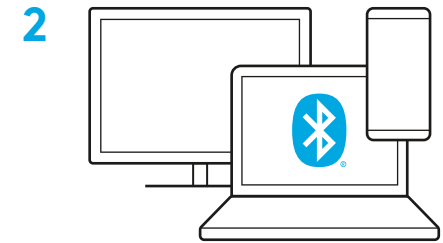
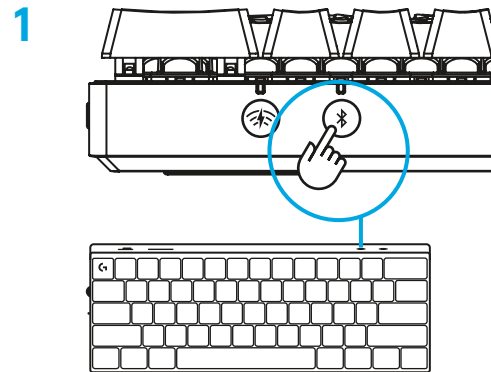

logitechG.com/ghub

Preuzmite i instalirajte softver za G HUB na PC/MAC računalo radi najboljeg doživljaja igranja (G HUB sadrži u sebi opis značajki).

Otvorite www.logitechG.com/ghub

PUNJENJE TIPKOVNICE

- 1 Utaknite *USB-C* kabel u priključak na prednjoj strani tipkovnice.

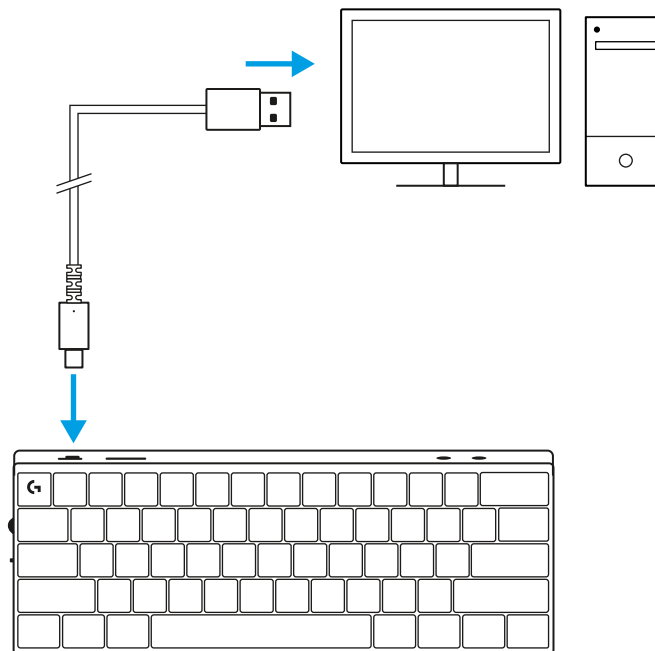

- 2 Spojite kabel na računalo.
Signalno svjetlo baterije pulsirat će zeleno za vrijeme punjenja i svijetlit će stalno zeleno kada je baterija napunjena.

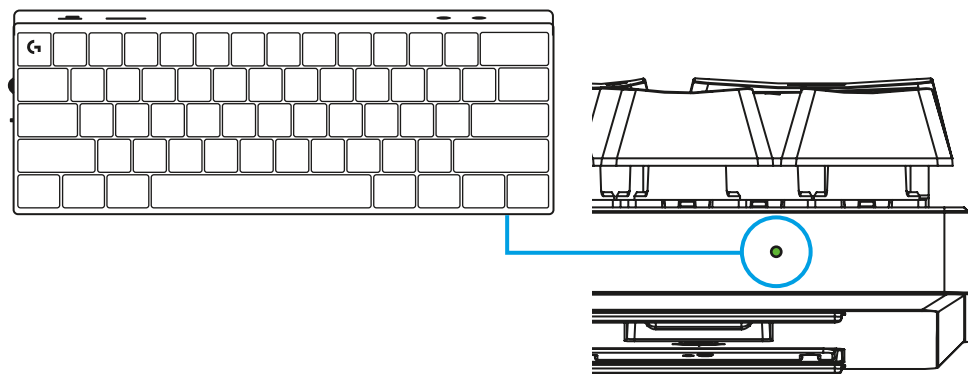

NAČIN RADA ZA IGRANJE



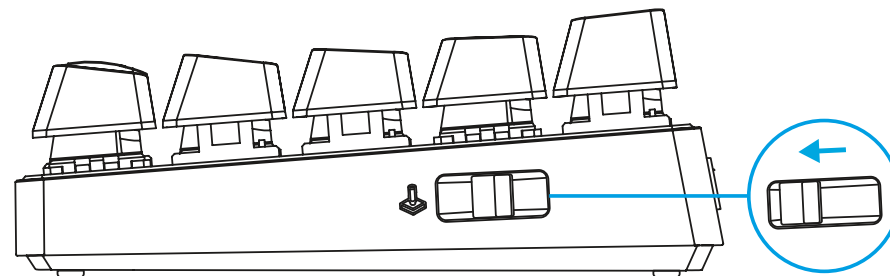

Uključivanje načina rada za igranje onemogućit će se funkcije tipke Windows kako bi se onemogućilo nehotično aktiviranje.

Razne tipke možete također onemogućiti u postavkama za Ghub.





KOMBINACIJE TIPKI

Kontrole medijskih sadržaja

FN + 	Reproduciraj/pauziraj
FN + 	Utišavanje
FN + 	Prethodna pjesma
FN + 	Sljedeća pjesma

ESC tipke

FN + 	`
FN + SHIFT + 	~

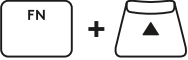
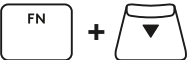
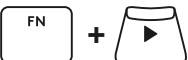
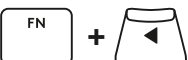

Tipke sa strelicama

	Strelica za gore
	Strelica za dolje
	Strelica za desno
	Strelica za lijevo



Funkcijske tipke

	Snimka zaslona
	Početak
	Stranica naviše
	Stranica naniže
	Zaključavanje listanja
	Kraj
	Insert
	Stanka/Prekid

Regulacija osvjetljenja

	Smanjivanje svjetline tipkovnice
	Povećavanje svjetline tipkovnice
	Cikličko kretanje kroz animacijski efekt
	Cikličko kretanje kroz animacijske parametre

Sklopke profila

  	Aktiviranje jednog od tri ugrađena profila memorije
-------------------------------------------------------------------------------------------------------------------------------------------------------------------------------------------------------------------------------------------------------------------	-----------------------------------------------------

Uključivanje/isključivanje pune prilagodbe tipki

	Omogućivanje pune prilagodbe tipki
	Prebacivanje između zadanog i prilagođenog rasporeda

PREGLED PROIZVODA

Prikaz odozgo

- 1 Prekidač za napajanje
- 2 Port tipa C
- 3 **BLUETOOTH**® dugme
- 4 **LIGHTSPEED** dugme
- 5 Prekidač režima igre
- 6 Indikator napajanja
- 7 Točkić za jačinu zvuka
- 8 Caps lock indikator

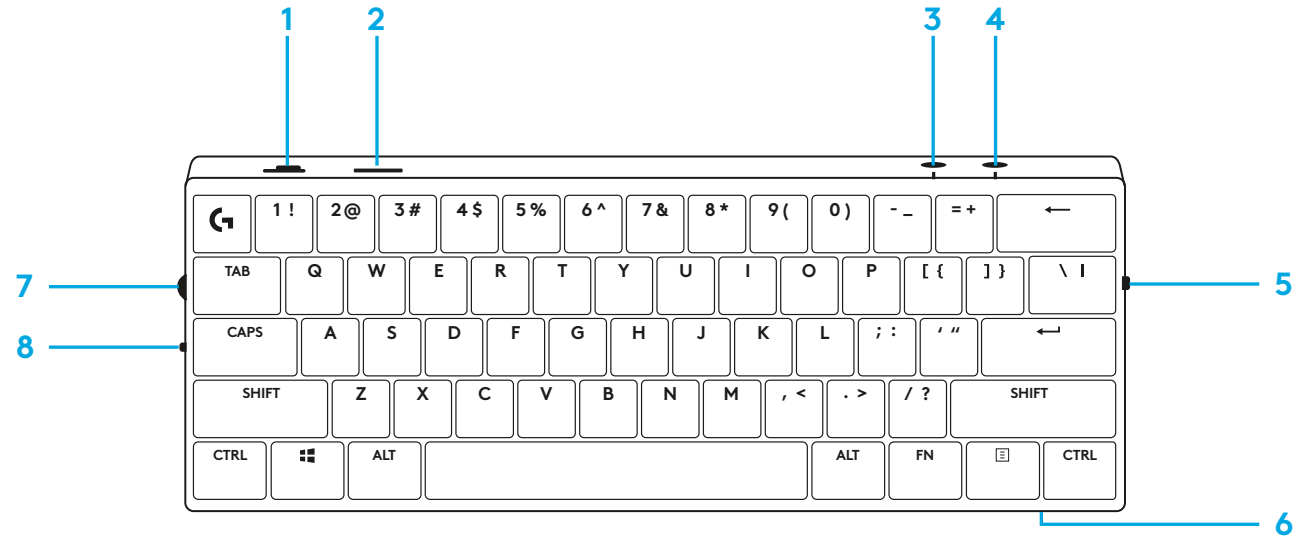

Prikaz odozdo:

- 1 Odeljak za odlaganje primopredajnika
- 2 Nožice koje mogu da se naginju

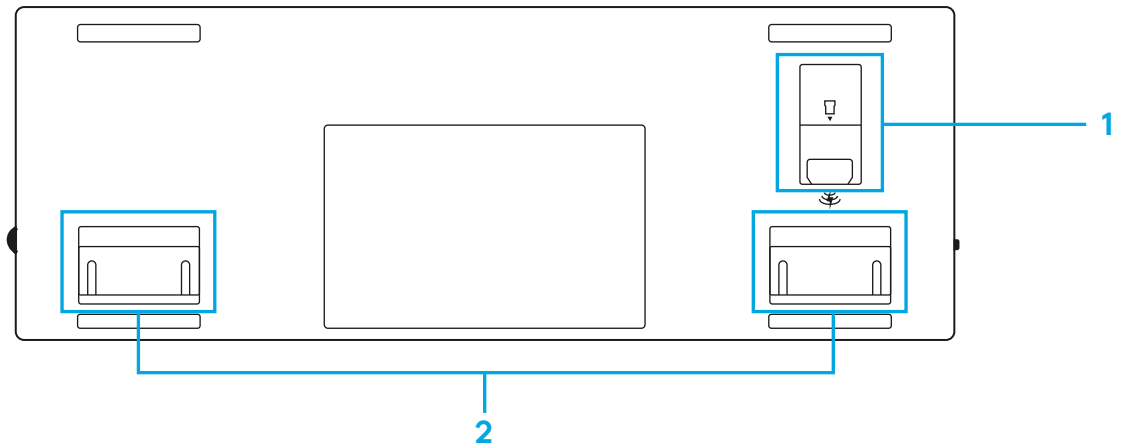

LIGHTSPEED VEZA

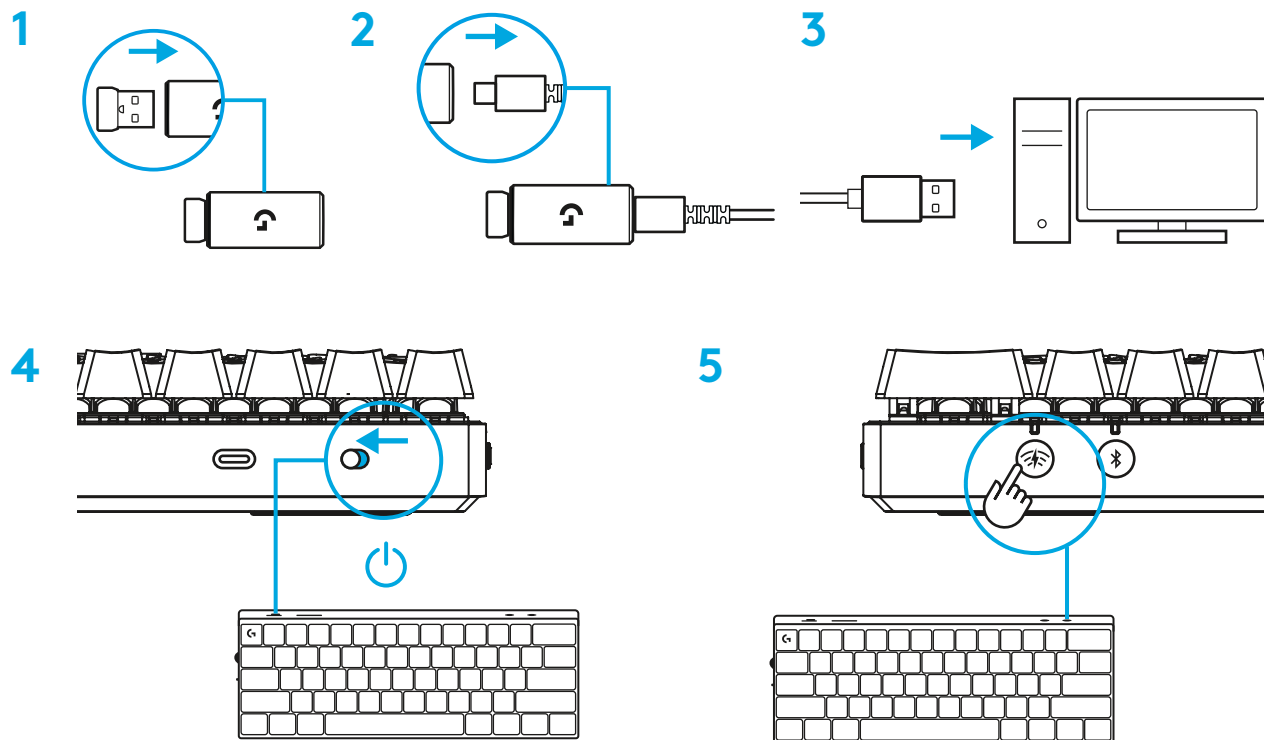

Preuzmite i instalirajte softver G HUB na PC/MAC računar za najbolji doživljaj igranja (G HUB ima uvodnu priču za isticanje). Posetite www.logitechG.com/ghub

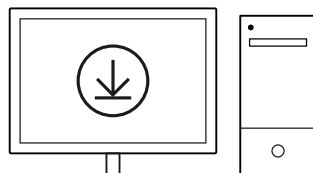

logitechG.com/ghub

BLUETOOTH® VEZA

1

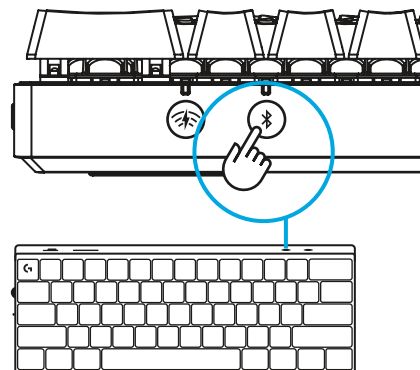

2

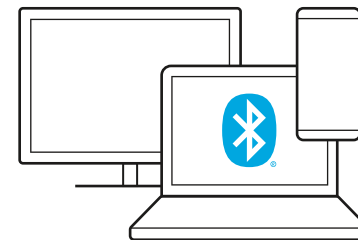

3

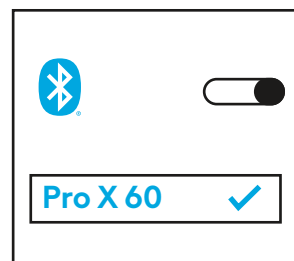

4

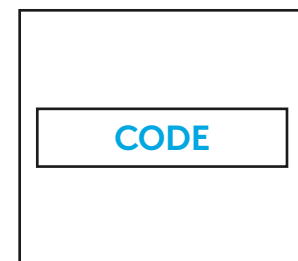

5

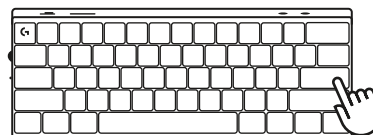

Preuzmite i instalirajte softver G HUB na PC/MAC računaru za najbolji doživljaj igranja (G HUB ima uvodnu priču za isticanje).
Posetite www.logitechG.com/ghub

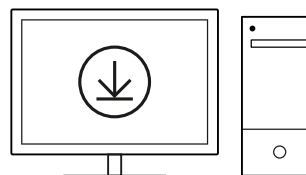

logitechG.com/ghub

PUNJENJE TASTATURE

1 Povežite *USB-C* kabl na port sa prednje strane tastature.

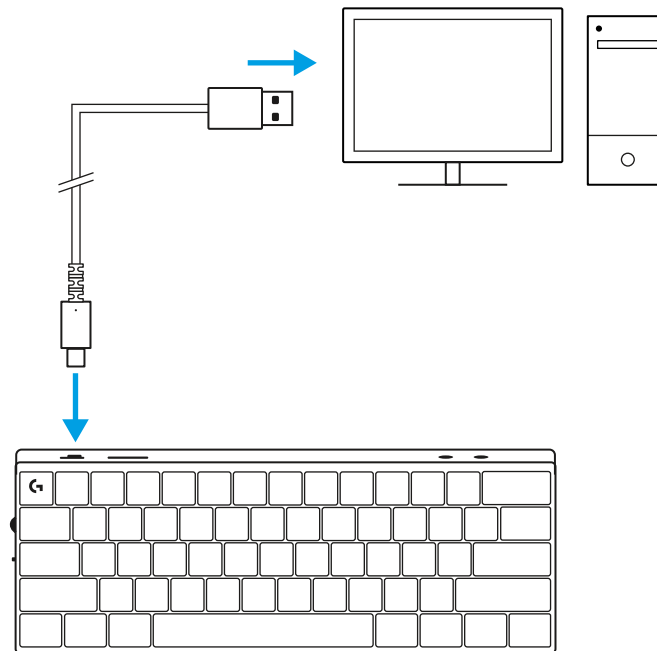

2 Povežite kabl na računar.

Svetlo indikatora baterije će treperiti u zelenoj boji tokom punjenja, a neprekidno će svetleti u zelenoj boji kada je potpuno napunjena.

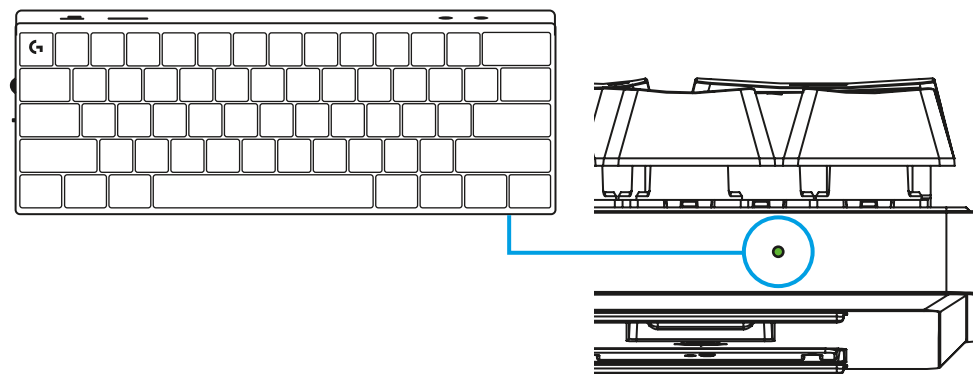

REŽIM IGRE

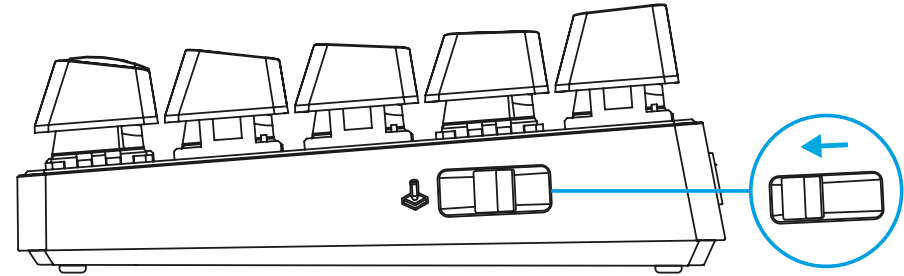

Uključivanje režima igre onemogućava funkcije Windows tastera da bi se sprečilo slučajno aktiviranje.

Takođe možete da onemogućite različite tastere u Ghub podešavanjima.





KOMBINACIJE TASTERA

Medijske komande

FN + 	Reprodukcija/pauza
FN + 	Isključivanje zvuka
FN + 	Prethodna numera
FN + 	Sledeća numera

ESC tasteri

FN + 	`
FN + SHIFT + 	~

Tasteri sa strelicama

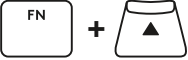
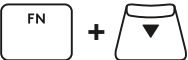
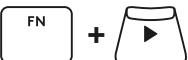
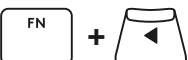
	Strelica nagore
	Strelica nadole
	Strelica desno
	Strelica levo

Funkcijski tasteri

	Snimak ekrana
	Početna
	Prethodna stranica
	Sledeća stranica
	Scroll Lock
	Završetak
	Umetanje
	Pauza/prelom

Kontrola osvetljenja

	Smanjivanje osvetljenosti tastature
	Povećavanje osvetljenosti tastature
	Kretanje kroz animirane efekte
	Kretanje kroz parametre animacije

Prekidači za profile

  	Aktivirajte neki od tri ugrađena memorijska profila
-------------------------------------------------------------------------------------------------------------------------------------------------------------------------------------------------------------------------------------------------------------------	-----------------------------------------------------

Uključeno/isključeno puno prilagođavanje tastera

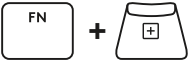
	Omogući puno prilagođavanje tastera
	Prebacivanje između podrazumevanog i prilagođenog rasporeda

PREGLED IZDELKA

Pogled od zgoraj

- 1 Stikalo za vklop/izklop
- 2 Vrata tipa-C
- 3 Gumb *BLUETOOTH*[®]
- 4 Gumb *LIGHTSPEED*
- 5 Stikalo za igralni način
- 6 Indikator vklopa/izklopa
- 7 Kolesce za nastavitve glasnosti
- 8 Indikator tipke Caps Lock



Pogled od spodaj

- 1 Shramba za zaščitni ključ
- 2 Nagibne nogice

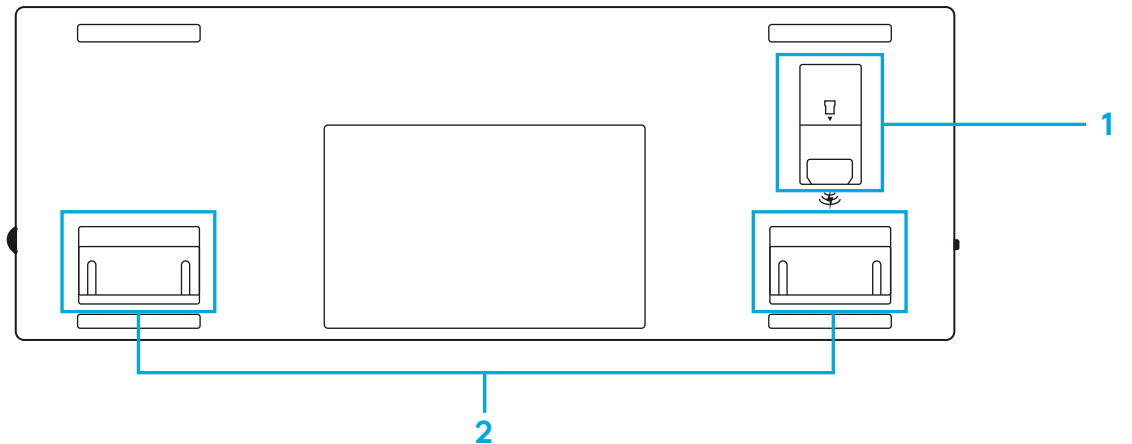

POVEZAVA LIGHTSPEED

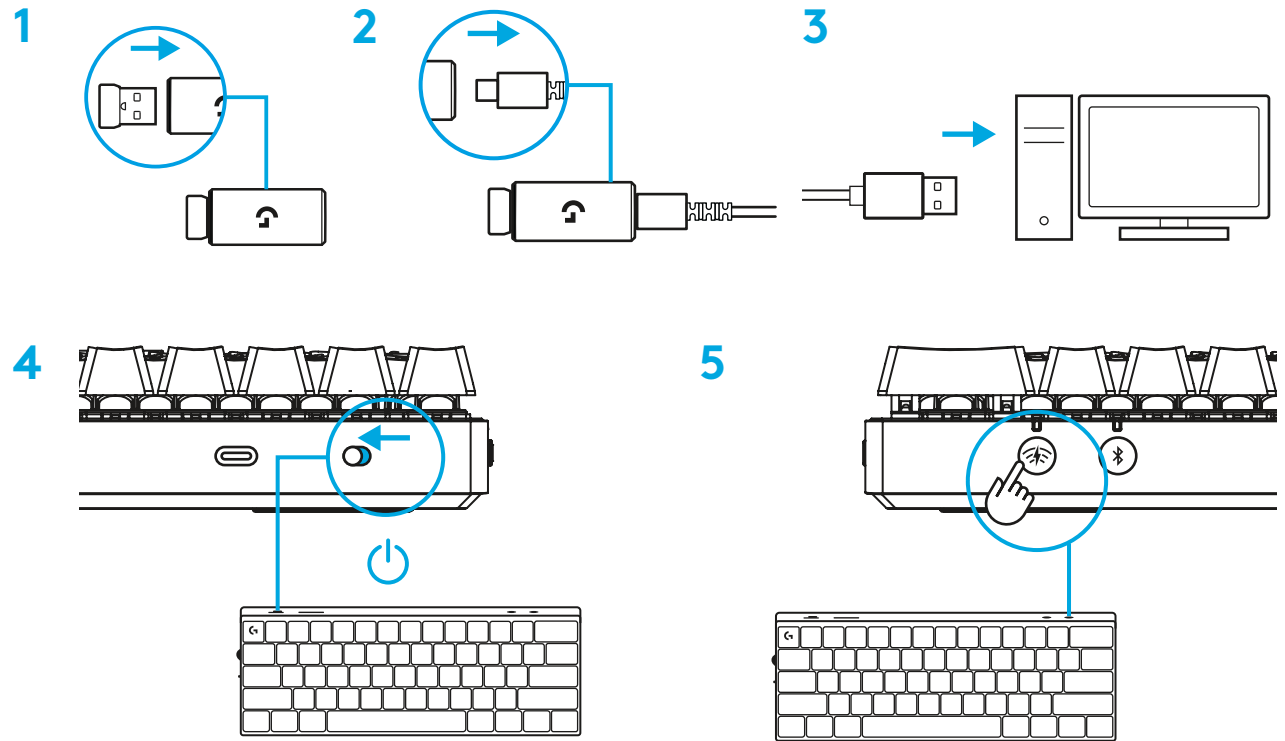

Prenesite in namestite programsko opremo G HUB na svoj PC/MAC za najboljšo igralno izkušnjo (G HUB ima zgodbo o priučitvi za funkcije). Obiščite www.logitechG.com/ghub

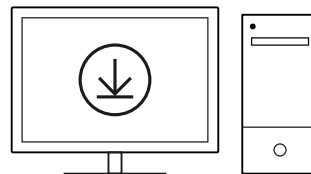

logitechG.com/ghub

BLUETOOTH® POVEZLJIVOST

1

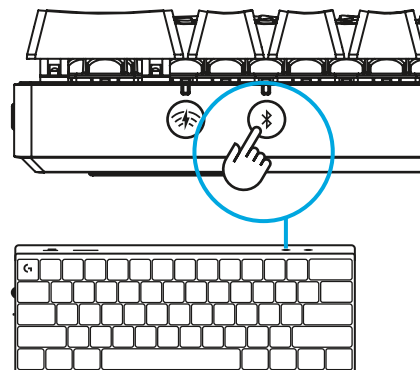

2

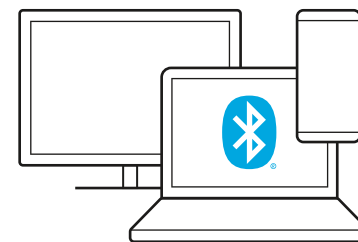

3

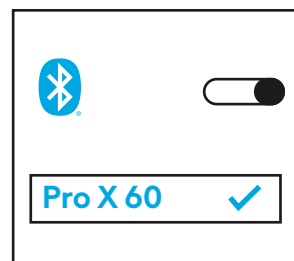

4

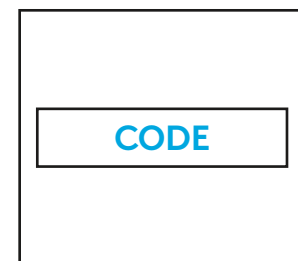

5

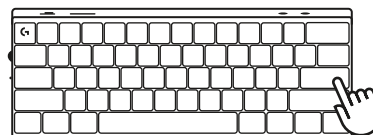

Prenesite in namestite programsko opremo G HUB na svoj PC/MAC za najboljšo igralno izkušnjo (G HUB ima zgodbo o priučitvi za funkcije).
Obiščite www.logitechG.com/ghub

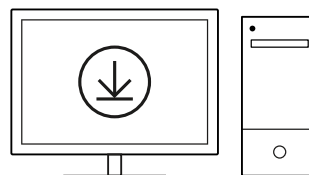

logitechG.com/ghub

POLNENJE TIPKOVNICE

1 Vstavite kabel *USB-C* v vrata na sprednji strani tipkovnice.

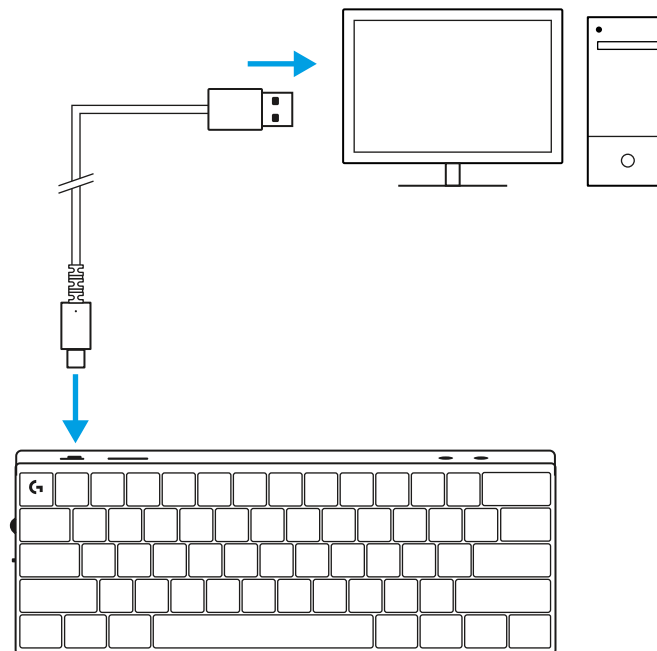

2 Kabel priključite v vaš računalnik.
Indikatorska lučka baterije utripa zeleno med polnjenjem
in sveti zeleno, ko je popolnoma napolnjena.

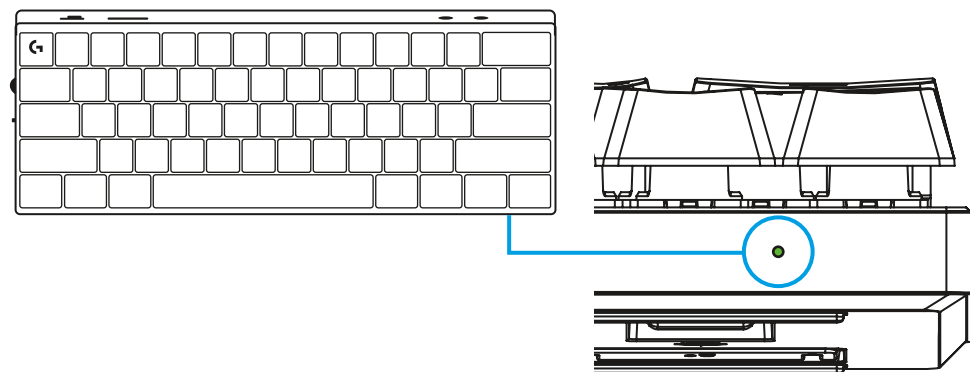

IGRALNI NAČIN

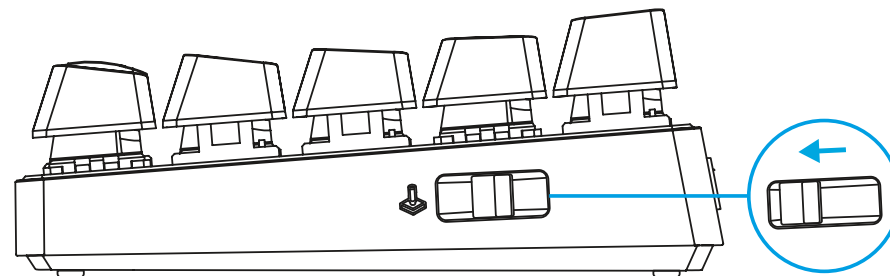

Če vklopite igralni način, boste onemogočili funkcije tipk Windows, da preprečite nenamerno sprožitev.

V nastavitvah Ghub lahko prav tako onemogočite različne tipke.





KOMBINACIJE TIPK

Upravljalni gumbi za večpredstavnost

FN + 	Predvajanje/začasna zaustavitev
FN + 	Nemo
FN + 	Prejšnji posnetek
FN + 	Naslednji posnetek

Tipke ESC

FN + 	`
FN + SHIFT + 	~

Puščične tipke

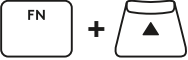
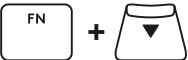
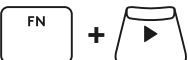
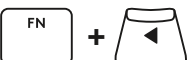
	Puščica gor
	Puščica dol
	Puščica desno
	Puščica levo

Funkcijske tipke

	Posnetek zaslona
	Domov
	Funkcija »Page up«
	Funkcija »Page down«
	Funkcija »Scroll lock«
	Končaj
	Vstavi
	Začasna zaustavitev/ premor

Nadzor osvetlitve

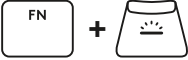
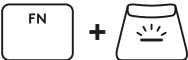
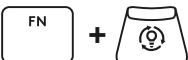
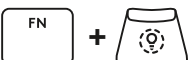
	Zmanjšaj svetlost tipkovnice
	Povečaj svetlost tipkovnice
	Kroži skozi učinek animacije
	Kroži skozi parametre animacije

Preklop med profili

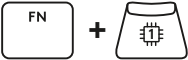
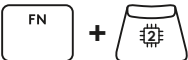
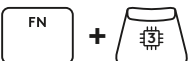
  	Aktivirajte enega izmed treh integriranih pomnilniških profilov
-------------------------------------------------------------------------------------------------------------------------------------------------------------------------------------------------------------------------------------------------------------------	-----------------------------------------------------------------

Vklop/izklop popolne prilagoditve tipk

	Omogoči popolno prilagoditev tipk
	Stikalo za preklop med privzeto in prilagojeno razporeditvijo

PREZENTAREA GENERALĂ A PRODUSULUI

Vedere de sus

- 1 Buton de alimentare
- 2 Port tip C
- 3 Buton *BLUETOOTH*[®]
- 4 Buton LIGHTSPEED
- 5 Butonul Mod joc
- 6 Indicatorul luminos pentru alimentare
- 7 Rotiță de volum
- 8 Indicatorul luminos pentru majuscule

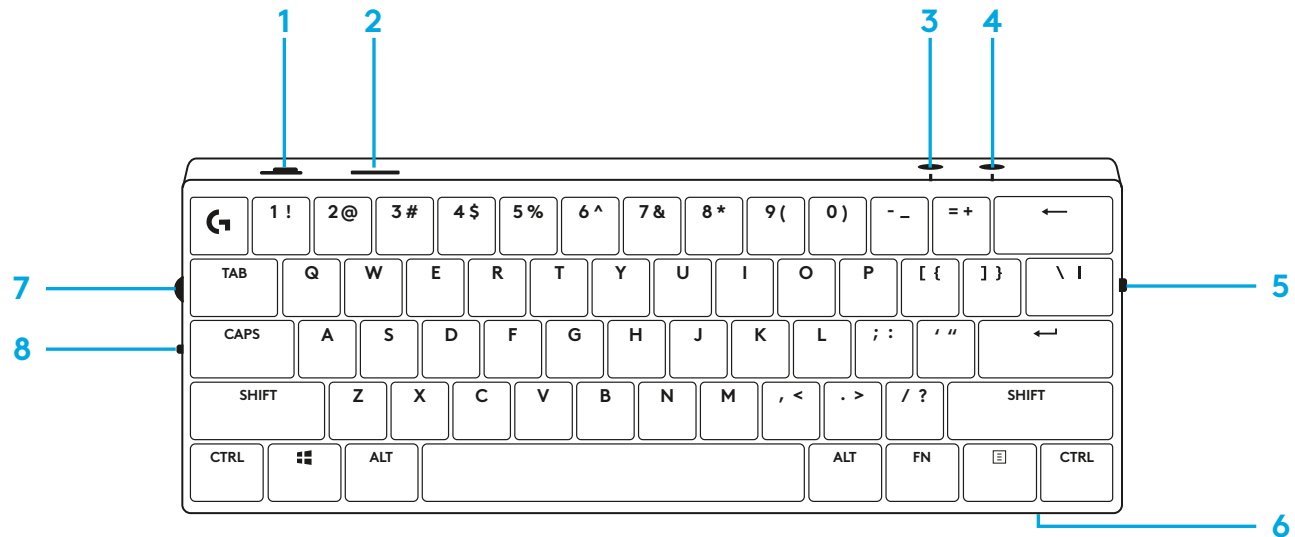

Vedere de jos

- 1 Compartimentul pentru cheia hardware
- 2 Piciorușe de înclinare

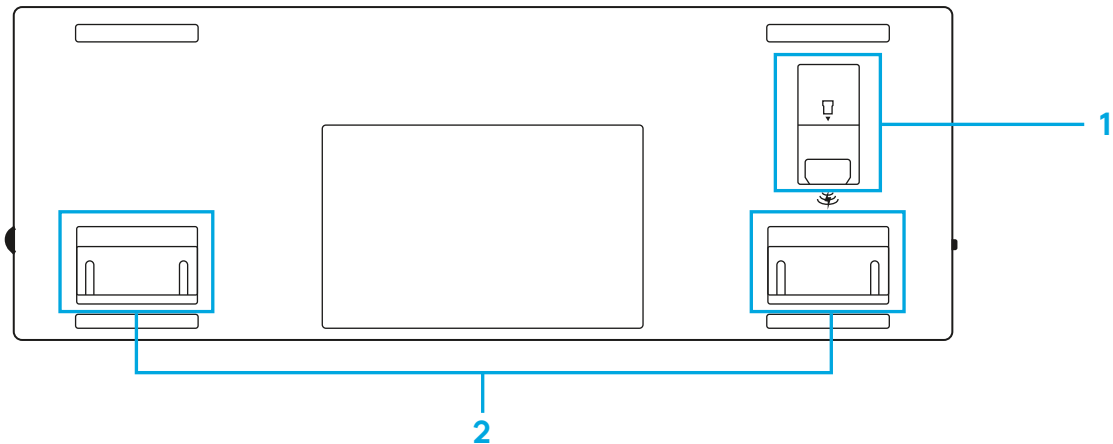

CONEXIUNEA LIGHTSPEED

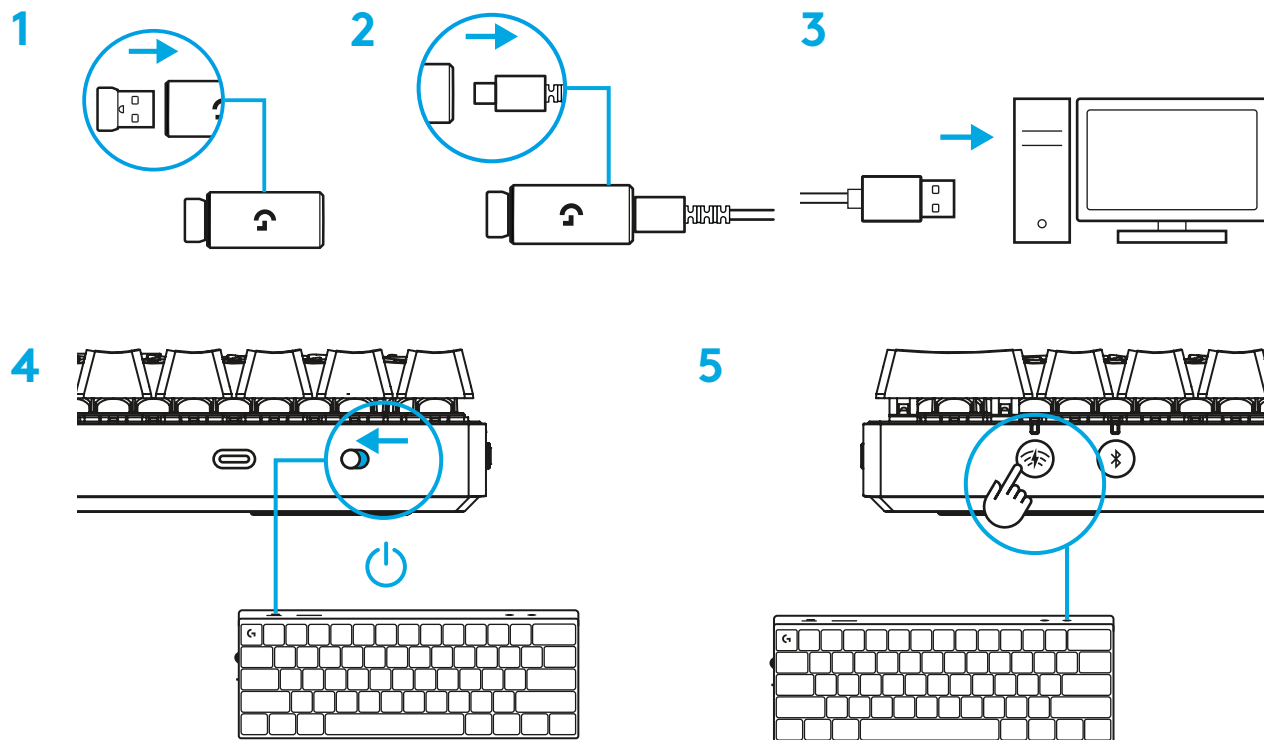

Descărcăți și instalați software-ul G HUB pe PC/MAC pentru a obține cea mai bună experiență în jocuri (G HUB oferă o inițiere în ceea ce privește funcționalitățile). Accesați www.logitechG.com/ghub

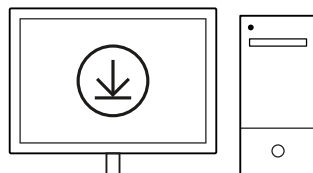

logitechG.com/ghub

CONECTAREA PRIN BLUETOOTH®

1

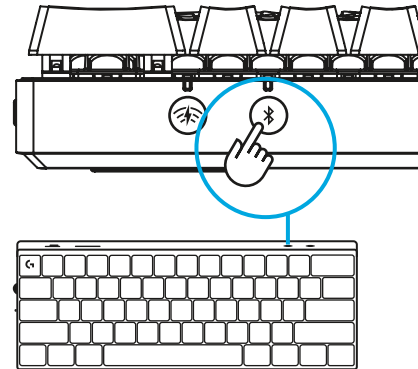

2

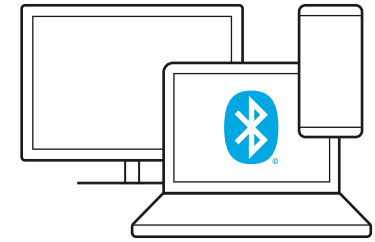

3

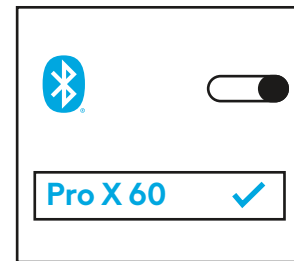

4

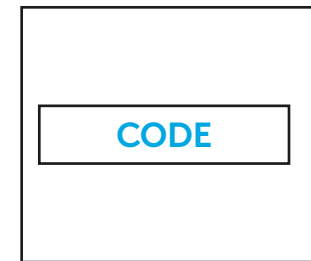

5

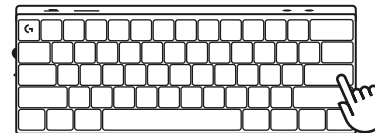

Descărcăți și instalați software-ul G HUB pe PC/MAC, pentru a obține cea mai bună experiență în jocuri (G HUB oferă o inițiere în ceea ce privește funcționalitățile). Accesați www.logitechG.com/ghub

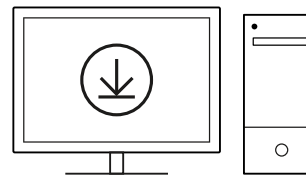

logitechG.com/ghub

ÎNCĂRCAREA TASTATURII

- 1 Introduceți cablul *USB-C* în port, în partea din față a tastaturii.

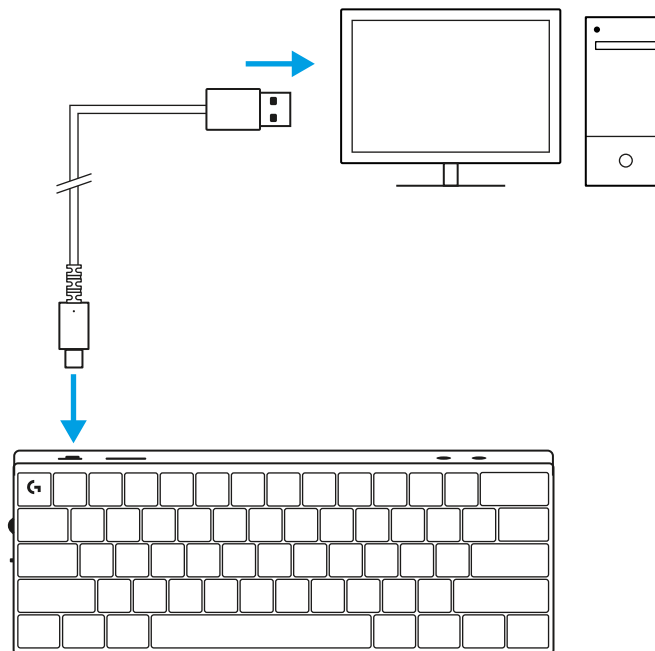

- 2 Conectați cablul la computer.
Lumina care indică starea bateriei va pulsa verde în timpul încărcării și va deveni verde constant când bateria este încărcată complet.

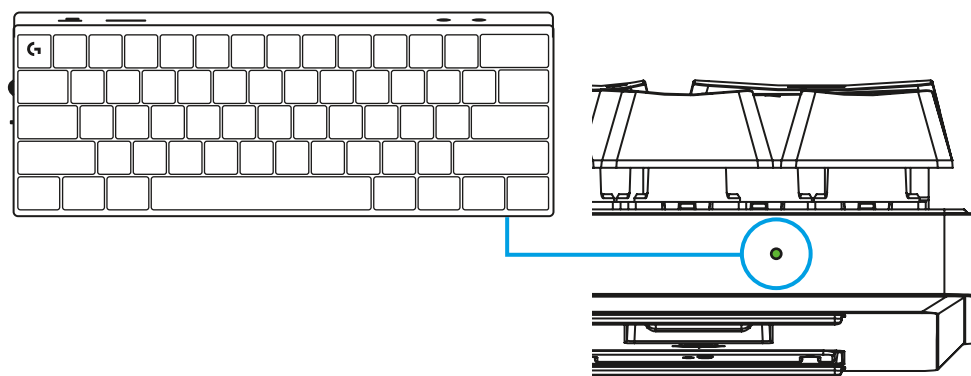

MODUL JOC





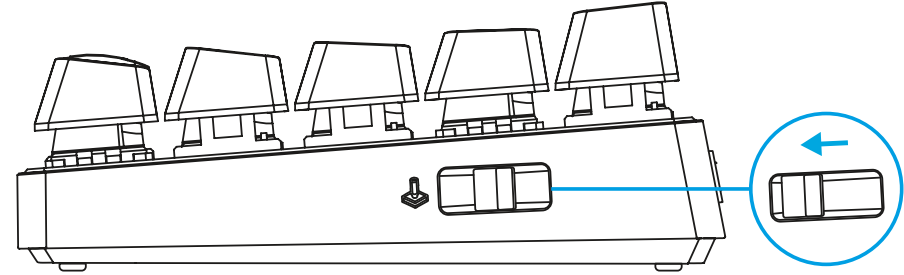



Trecerea la modul Joc va dezactiva funcțiile tastei Windows pentru a evita declanșarea accidentală.

De asemenea, puteți dezactiva diverse taste din setările Ghub.







COMBINAȚII DE TASTE





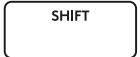



Comenzi media

 + 	Redare/pauză
 + 	Dezactivare sunet
 + 	Piesa anterioară
 + 	Piesa următoare

Tasta Escape

 + 	~
 +  + 	~

Taste săgeți

 + 	Săgeată sus
 + 	Săgeată jos
 + 	Săgeată dreapta
 + 	Săgeată stânga

Taste funcționale

 + 	Captură de ecran
 + 	Acasă
 + 	Pagină sus
 + 	Pagină jos
 + 	Blocare derulare
 + 	Sfârșit
 + 	Inserare
 + 	Pauză

Comandă lumină

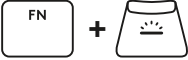
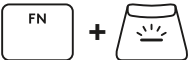
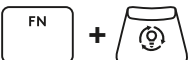
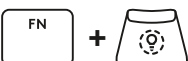
	Scăderea luminozității tastaturii
	Creșterea luminozității tastaturii
	Schimbarea efectului de animație
	Schimbarea parametrilor animației

Comutatoare pentru profil

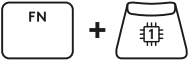
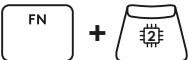
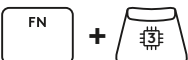
  	Activați unul din cele trei profile integrate
-------------------------------------------------------------------------------------------------------------------------------------------------------------------------------------------------------------------------------------------------------------------	-----------------------------------------------

Personalizare completă a tastelor activată/dezactivată

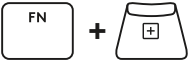
	Permiteți personalizarea completă a tastelor
	Comutați între setările Implicit și Personalizat pentru dispunerea tastelor

ÜRÜNE GENEL BAKIŞ

Üstten Görünüm

- 1 Güç düğmesi
- 2 Tip C bağlantı noktası
- 3 Bluetooth® tuşu
- 4 LIGHTSPEED tuşu
- 5 Oyun Modu Tuşu
- 6 Güç göstergesi
- 7 Ses Düzeyi Tekerleği
- 8 Caps Lock göstergesi

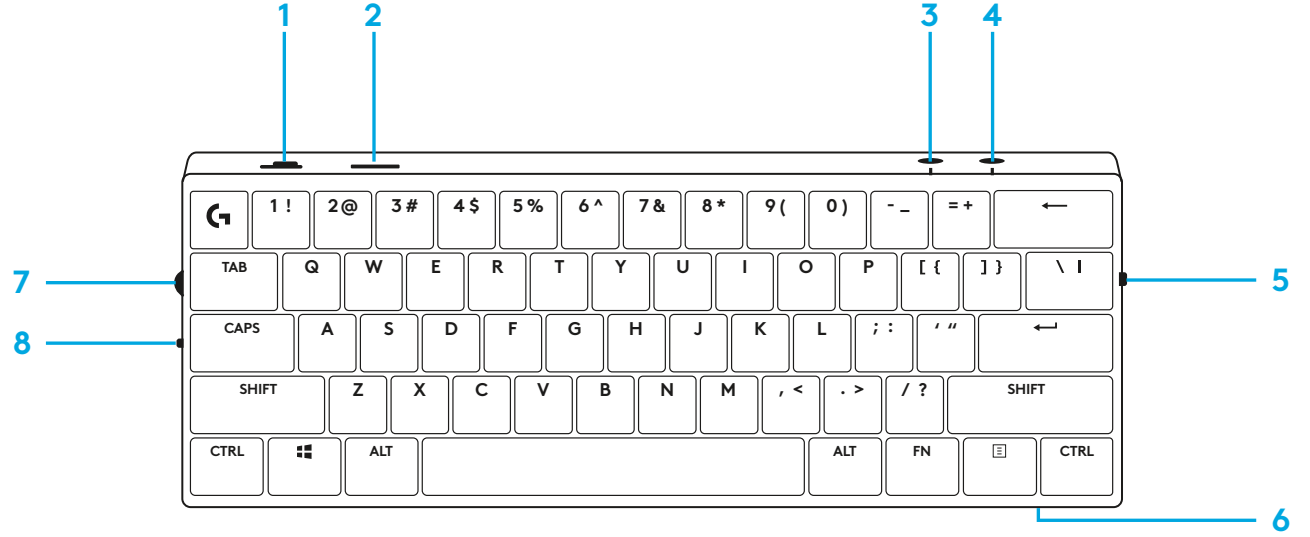

Alttan Görünüm

- 1 Dongle depolama
- 2 Eğimli ayaklar

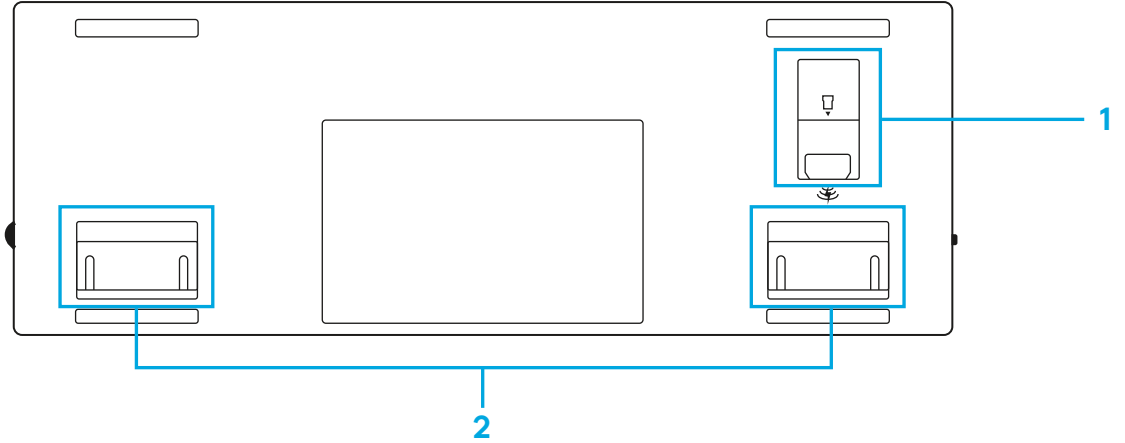

LIGHTSPEED BAĞLANTISI

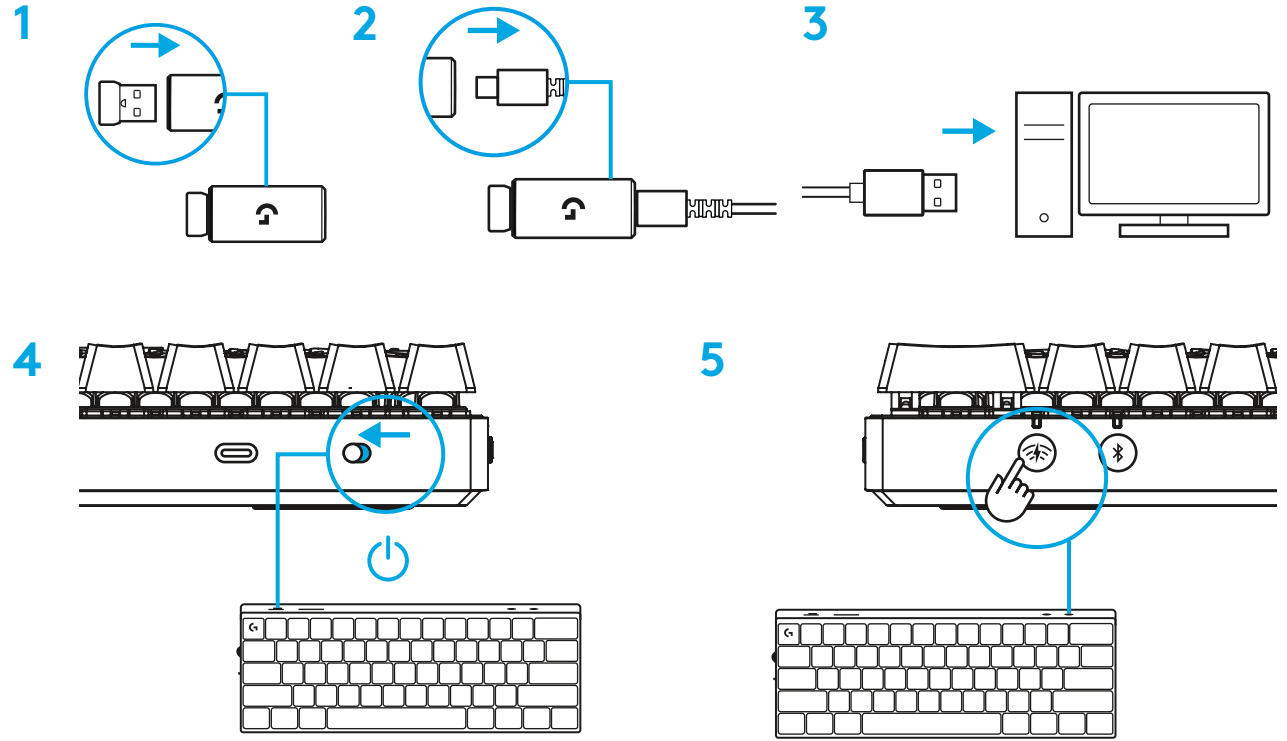

En iyi oyun deneyimi için PC/MAC cihazınıza G HUB yazılımını indirip yükleyin (G HUB'da yazılım özellikleriyle ilgili bilgilendirici içerikler mevcuttur).
www.logitechG.com/ghub adresine gidin

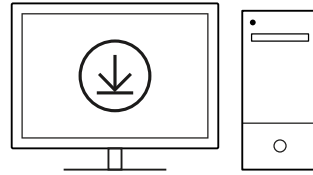

logitechG.com/ghub

BLUETOOTH® BAĞLANTISI

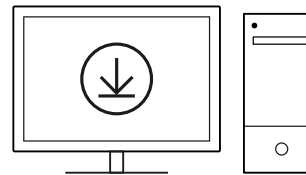
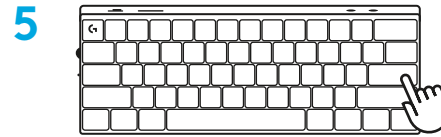
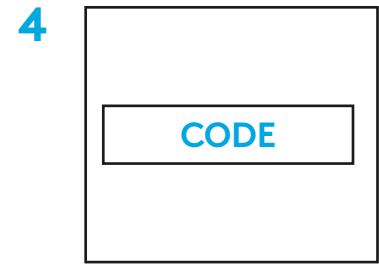
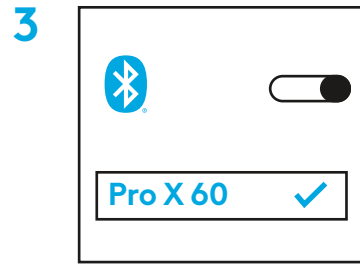
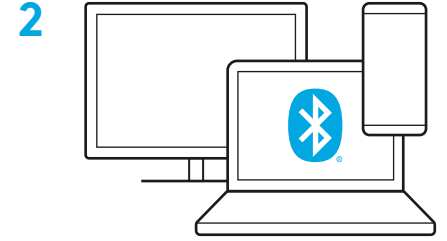
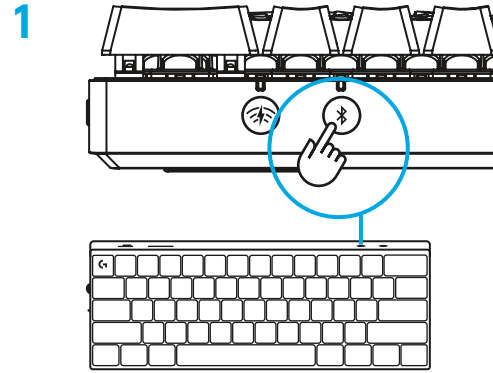

logitechG.com/ghub

En iyi oyun deneyimi için PC/MAC cihazınıza G HUB yazılımını indirip yükleyin (G HUB'da yazılım özellikleriyle ilgili bilgilendirici içerikler mevcuttur).
www.logitechG.com/ghub adresine gidin

KLAVYENİZİ ŞARJ ETME

- 1 USB-C kablosunu klavyenin ön kısmındaki bağlantı noktasına takın.

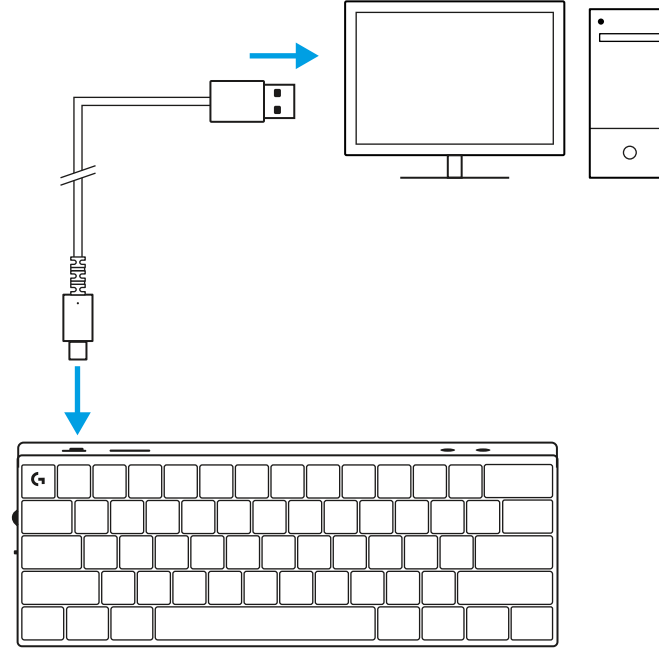

- 2 Kabloyu bilgisayarınıza bağlayın.
Pil gösterge ışığı şarj olurken yeşil renkte yanıp sönecek ve tamamen şarj olduğunda sabit yeşile dönecektir.

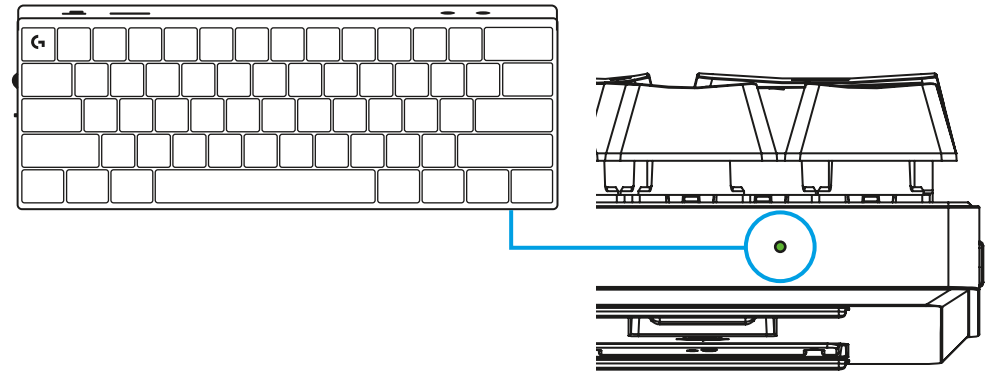

OYUN MODU



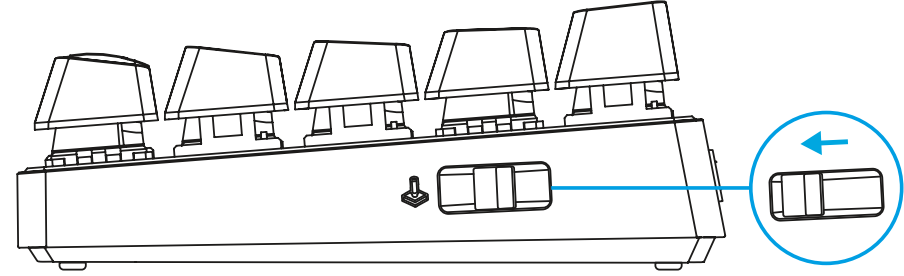

Oyun moduna geçiş, yanlışlıkla tetiklemeyi önlemek için Windows tuş işlevlerini devre dışı bırakır.

Ghub ayarlarında farklı tuşları da devre dışı bırakabilirsiniz.





TUŞ KOMBİNASYONLARI



Medya Kontrolleri

FN + 	Oynat/Duraklat
FN + 	Sesi Kapat
FN + 	Önceki Parça
FN + 	Sonraki Parça

Esc Tuşları

FN + 	`
FN + SHIFT + 	~

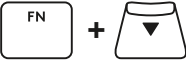
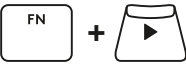



Ok Tuşları

	Yukarı Ok
	Aşağı Ok
	Sağ Ok
	Sol Ok



İşlev Tuşları

	Ekran Görüntüsü
	Home
	Sayfada Yukarı Git
	Sayfada Aşağı İn
	Kaydırma Kilidi
	Sonlandır
	Ekle
	Duraklat / Ara Ver

Aydınlatma Kontrolü

	Klavye parlaklığını azalt
	Klavye parlaklığını artır
	Animasyon efektleri arasında geçiş yap
	Animasyon parametreleri arasında geçiş yap

Profil Değişirme

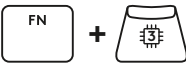
  	Yerleşik hafıza profillerinden birini etkinleştir
-------------------------------------------------------------------------------------------------------------------------------------------------------------------------------------------------------------------------------------------------------------------	---------------------------------------------------

Tüm Tuşlar için Kişiselleştirme açık/kapalı

	Tüm Tuşlar için Kişiselleştirmeyi Etkinleştir
	Varsayılan Tasarım ile Kişiselleştirilmiş Tasarım arasında geçiş yap

نظرة عامة على المنتج

العرض من الأعلى

- 1 مفتاح التشغيل
- 2 منفذ Typ-C
- 3 زر Bluetooth®
- 4 زر LIGHTSPEED
- 5 مفتاح وضع الألعاب
- 6 مؤشر الطاقة
- 7 بكرة مستوى الصوت
- 8 ضوء مؤثر Caps lock

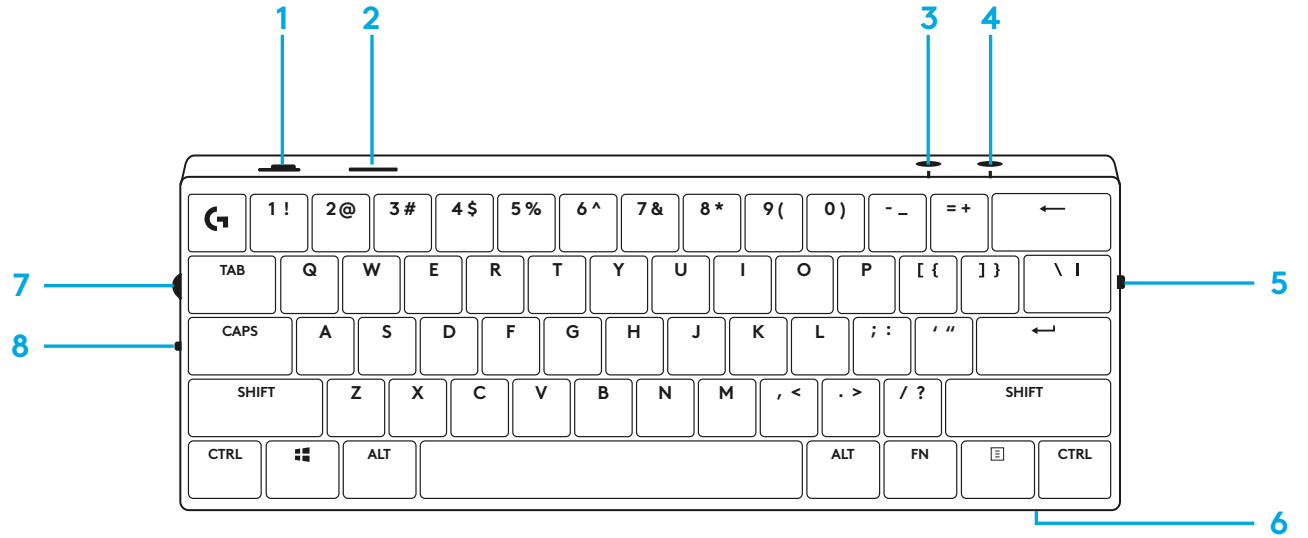

المنظر السفلي:

- 1 تخزين الدونغل
- 2 أرجل الإمالة.

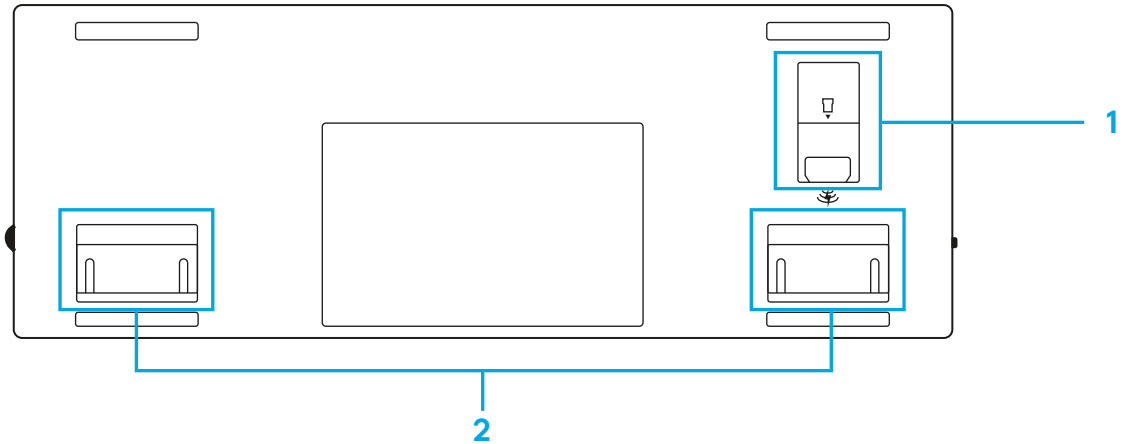

اتصال عبر تقنية LIGHTSPEED

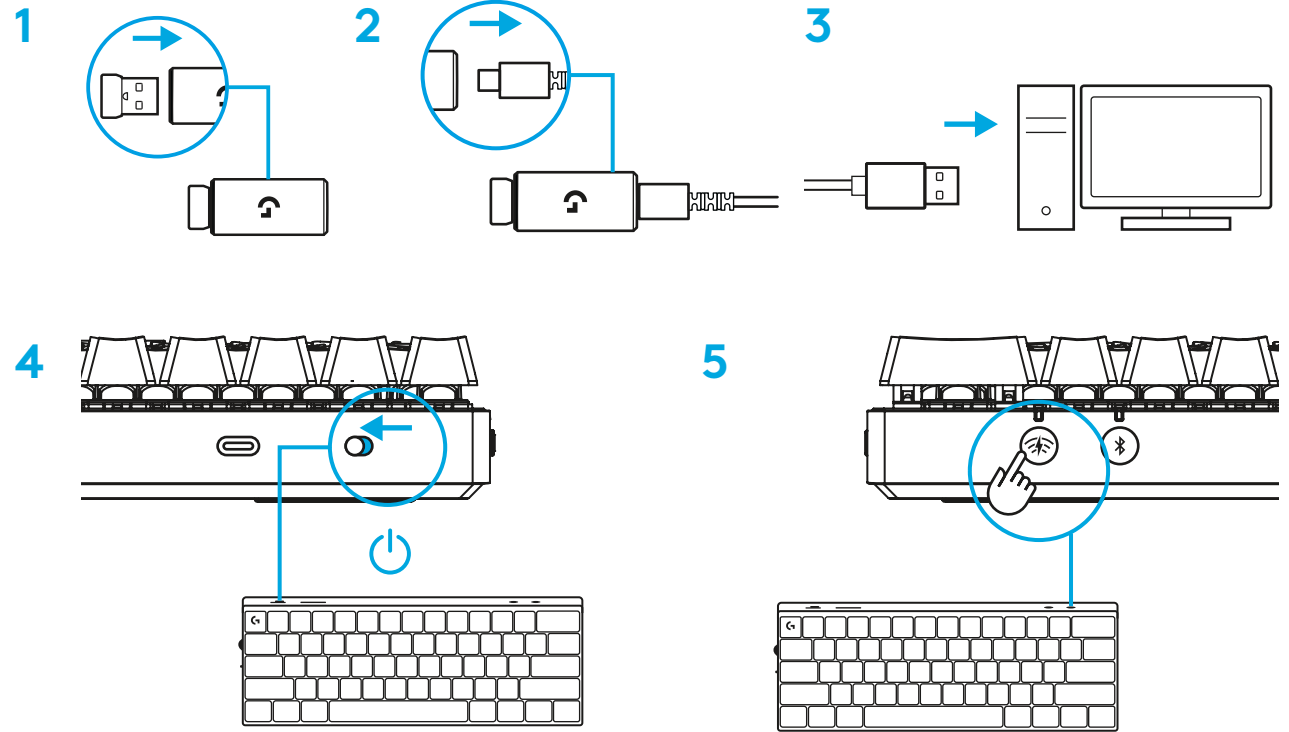

قم بتنزيل برنامج G HUB وتثبيته على جهاز الكمبيوتر المحمول/ جهاز MAC لتحصل على أفضل تجربة ألعاب (يحتوي G HUB على إعدادات للميزات).
انتقل إلى www.logitechG.com/ghub

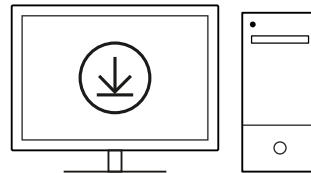

logitechG.com/ghub

اتصال BLUETOOTH®

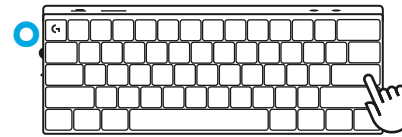
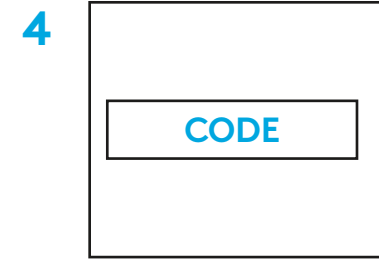
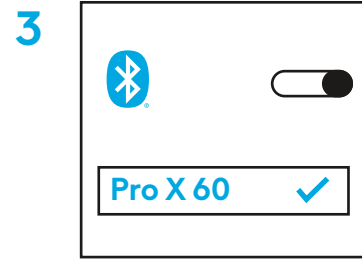
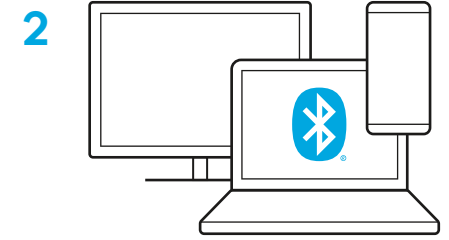
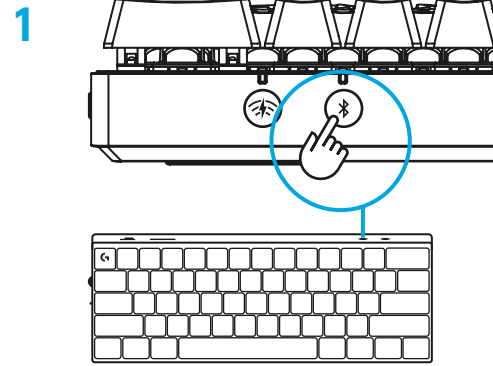

قم بتنزيل برنامج G HUB وتثبيته على جهاز الكمبيوتر المحمول/ جهاز MAC لتحصل على أفضل تجربة ألعاب (يحتوي G HUB على إعدادات للميزات).
انتقل إلى www.logitechG.com/ghub

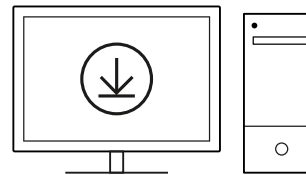

logitechG.com/ghub

شحن لوحة المفاتيح

1 أدخل كابل USB-C في المنفذ الموجود في الجزء الأمامي من لوحة المفاتيح.

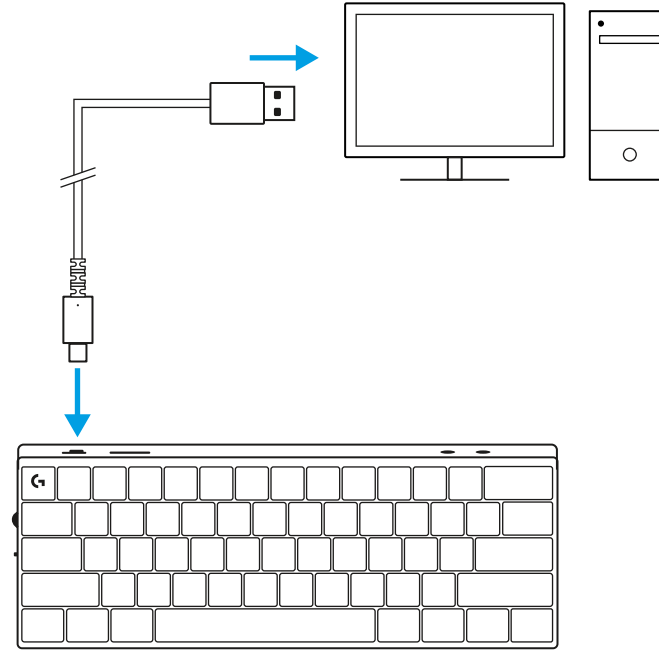

2 وصل الكابل بالكمبيوتر الشخصي. سينبض مصباح مؤشر البطارية باللون الأخضر أثناء الشحن ويصبح اللون الأخضر الثابت عند الشحن بالكامل.

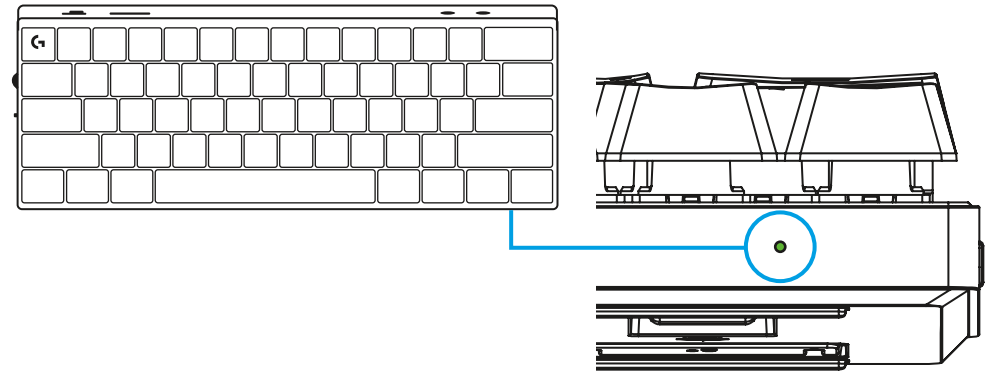

وضع الألعاب

سيؤدي تشغيل وضع اللعبة إلى تعطيل وظائف مفتاح Windows لتجنب التشغيل غير المقصود.

يمكنك أيضًا تعطيل المفاتيح المختلفة في إعدادات Ghub.

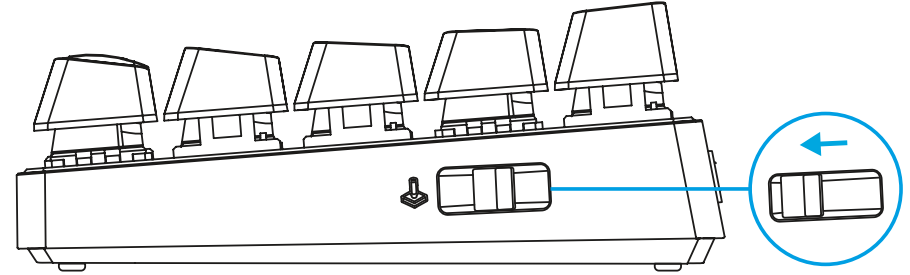

مجموعات الأزرار

عناصر التحكم في الوسائط

تشغيل/ إيقاف مؤقت	FN + [Pause]
كتم الصوت	FN + [Mute]
المسار السابق	FN + [Previous]
المسار التالي	FN + [Next]



مفاتيح Esc

,	FN + [Esc]
-	FN + SHIFT + [Esc]

مفاتيح الأسهم

السهم لأعلى	 + 
السهم لأسفل	 + 
السهم تجاه اليمين	 + 
السهم تجاه اليسار	 + 

مفاتيح وظائف

لقطة الشاشة	 + 
مفتاح Home	 + 
مفتاح Page up	 + 
مفتاح Page down	 + 
مفتاح Scroll Lock	 + 
مفتاح End	 + 
مفتاح Insert	 + 
مفتاح Pause/Break	 + 



التحكم في الإضاءة

تقليل سطوع لوحة المفاتيح	 + 
زيادة سطوع لوحة المفاتيح	 + 
التنقل بين تأثيرات الرسوم المتحركة	 + 
التنقل بين معلمات الرسوم المتحركة	 + 

مفاتيح ملف التعريف

تنشيط ملف من ملفات تعريف الذاكرة الثلاثة المدمجة	 + 
	 + 
	 + 

تشغيل/إيقاف تشغيل تخصيص لوحة المفاتيح الكاملة

تمكين تخصيص لوحة المفاتيح الكاملة	 + 
الانتقال للتبديل بين التخطيط الافتراضي والمخصص	

תצוגת מבט עליון

- 1 מתג הפעלה/כיבוי
- 2 יציאת USB-C
- 3 לחצן [®]BLUETOOTH
- 4 לחצן LIGHTSPEED
- 5 מתג מצב משחק
- 6 מחוון הפעלה
- 7 גולל עוצמת קול
- 8 מחוון Caps lock

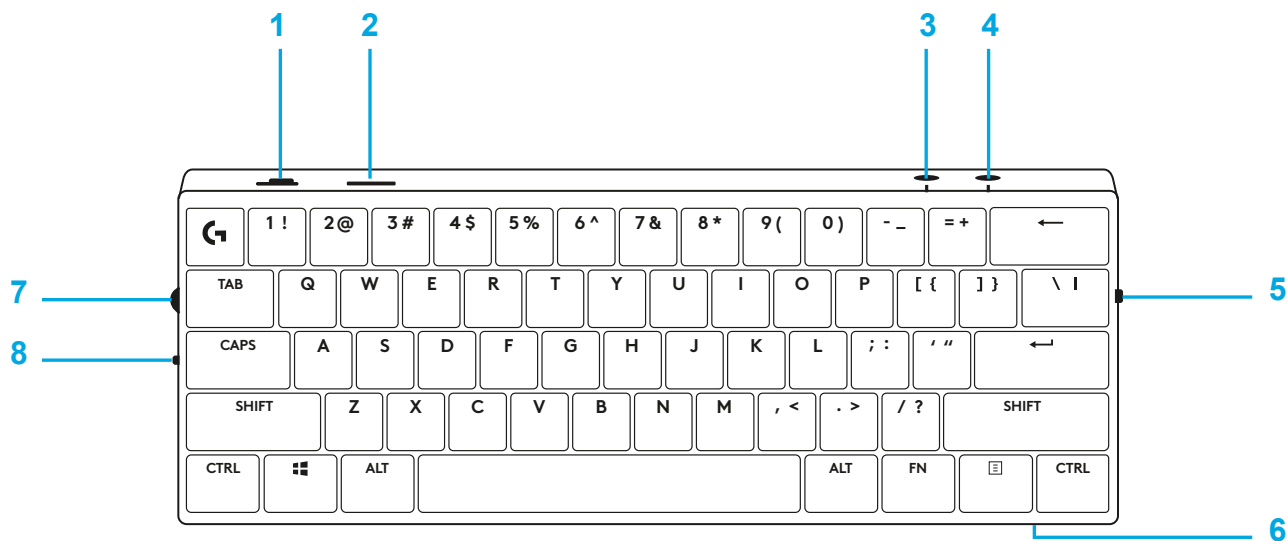

תצוגה מלמטה

- 1 אחסון דונגל
- 2 רגליות הטיה

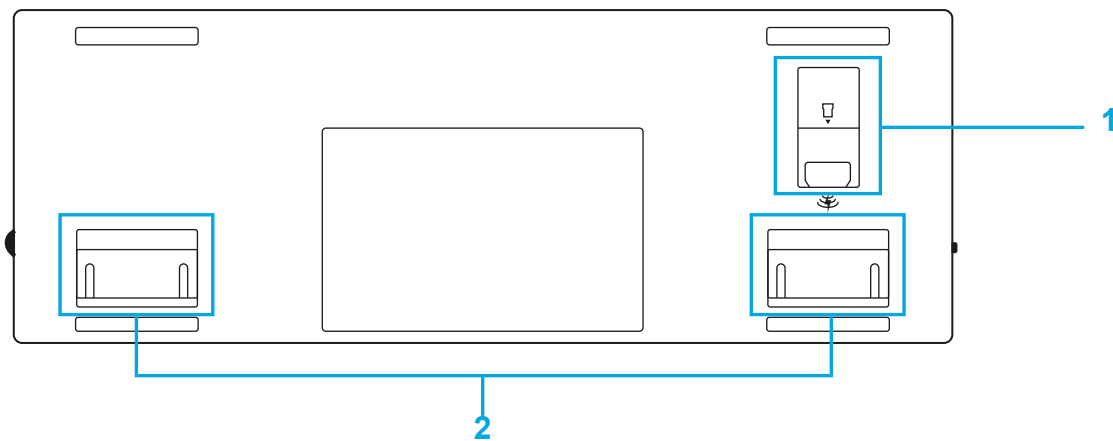

חיבור LIGHTSPEED

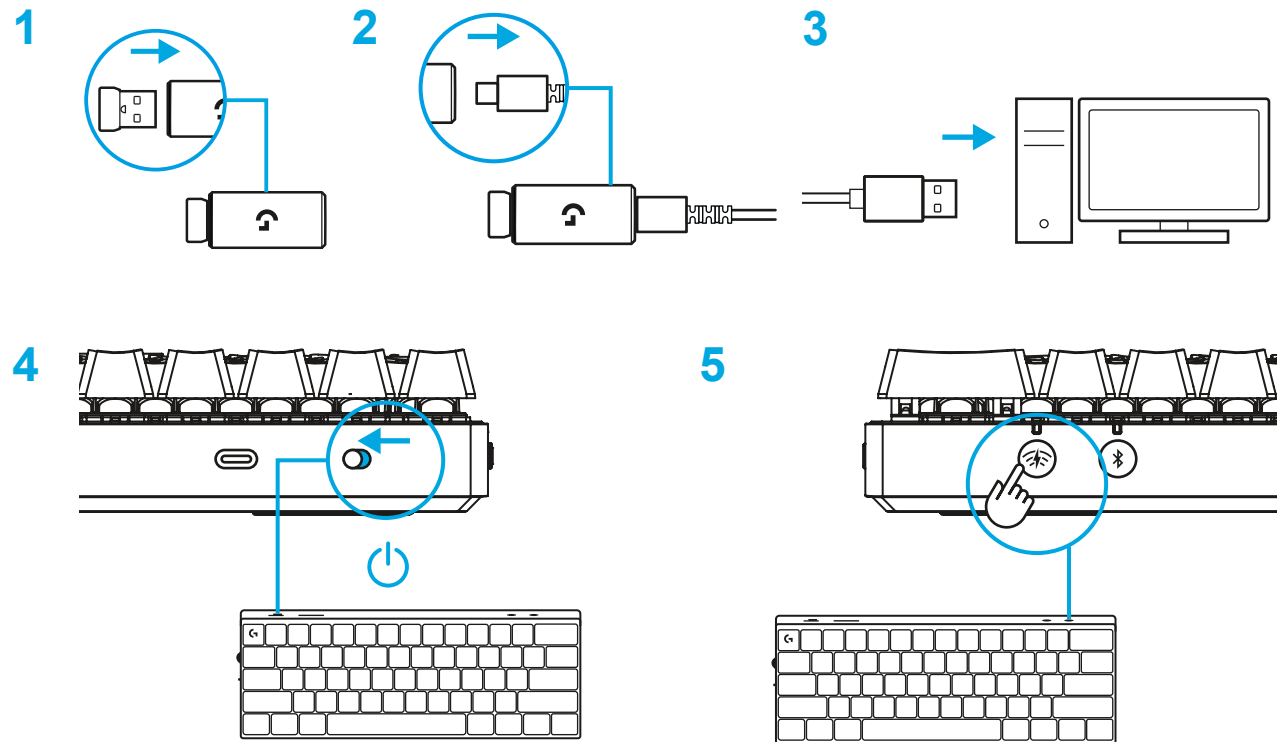

לחויית הגיימינג הטובה ביותר, הורד והתקן את תוכנת G HUB במחשב PC/MAC (ל-G HUB יש הדרכה על התכונות).
עבור אל www.logitechG.com/ghub

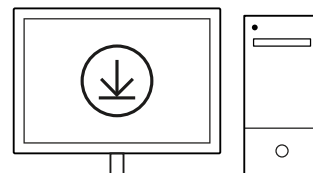

logitechG.com/ghub

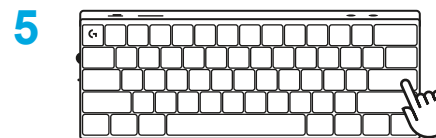
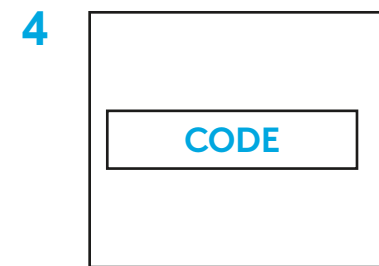
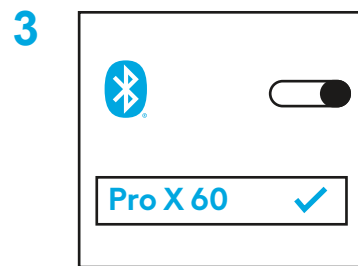
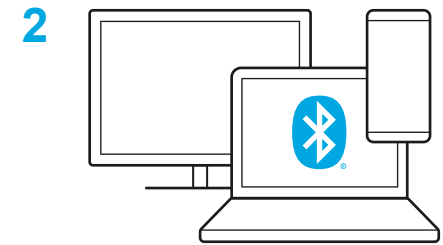
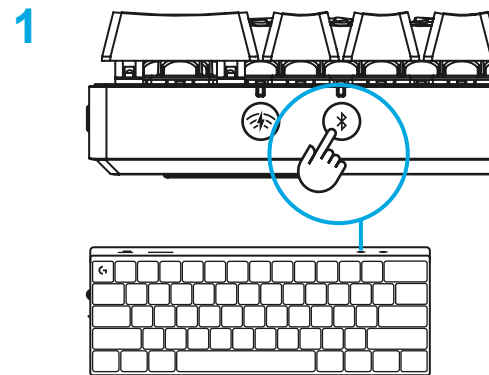

לחווית הגיימינג הטובה ביותר, הורד והתקן את תוכנת G HUB במחשב PC/MAC (ל-G HUB יש הדרכה על התכונות).
עבור אל www.logitechG.com/ghub

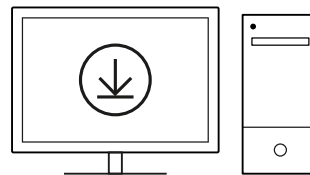

logitechG.com/ghub

1 חבר את כבל ה-USB-C לציאה שבקדמת המקלדת.

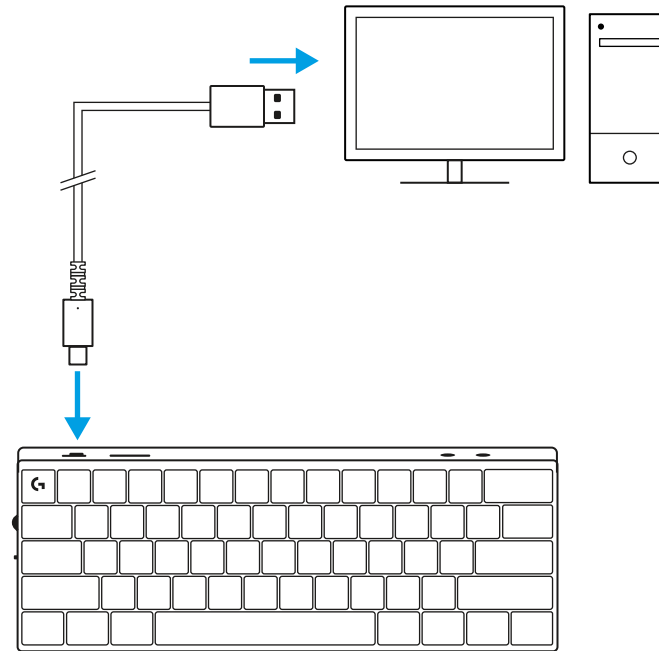

2 חבר את הכבל למחשב.
נורית חיווי הסוללה תהבהב לאט בירוק במהלך הטעינה, ותאיר בירוק רצוף לאחר טעינה מלאה.

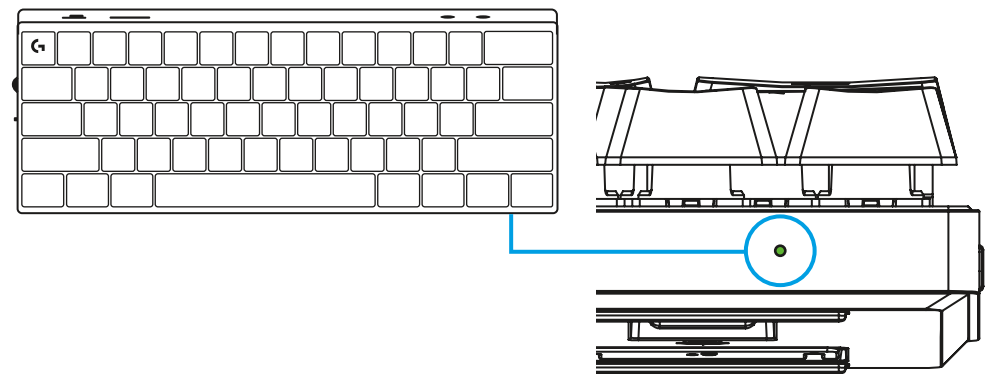

מצב משחק

החלפה למצב משחק תשבית את פונקציות המקש של Windows על מנת להימנע מהפעלות שגויות.

ניתן גם להשבית מקשים אחרים תחת הגדרות Ghub.

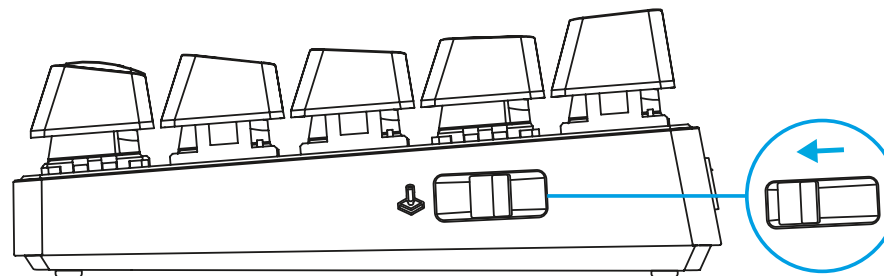



שילובי מקשים

פקדי מדיה

הפעלה/השהיה	FN + 
השתק	FN + 
רצועה קודמת	FN + 
רצועה הבאה	FN + 

















מקשי Esc

`	FN + 
~	FN + SHIFT + 

מקשי חיצים

מקש למעלה	 + 
מקש למטה	 + 
מקש ימינה	 + 
מקש שמאלה	 + 

מקשי פונקציה

צילום מסך	 + 
מסך הבית	 + 
Page up	 + 
Page down	 + 
Scroll lock	 + 
End	 + 
Insert	 + 
Pause / Break	 + 



בקרת תאורה

הנמך בהירות מקלדת	 + 
הגבר בהירות מקלדת	 + 
עבור שוב אפקט הנפשה	 + 
עבור שוב פרמטרי הנפשה	 + 

החלפות פרופיל

הפעל אחד משלושת פרופילי זכרון כלולים	 + 
	 + 
	 + 

כיבוי/הפעלה התאמה אישית של מקש מלא

אפשר התאמה אישית של מקש מלא	 + 
החלף למעבר בין פריסת ברירת מחדל למותאמת אישית	



©2023 Logitech. Logitech, Logitech G, Logi and their respective logos are trademarks or registered trademarks of Logitech Europe S.A. and/or its affiliates in the U.S. and other countries. All other trademarks are the property of their respective owners. Logitech assumes no responsibility for any errors that may appear in this manual. Information contained herein is subject to change without notice. The *Bluetooth*® word mark and logos are registered trademarks owned by Bluetooth SIG, Inc. and any use of such marks by Logitech is under license.

WEB-621-002341 003